

NEED MORE HELP?

For all support go to jabra.com/support

Jabra Evolve 75e



Quick start guide

How to connect

PC

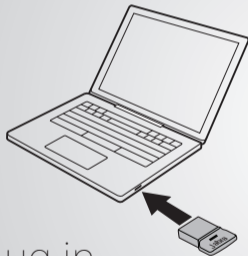

Plug in

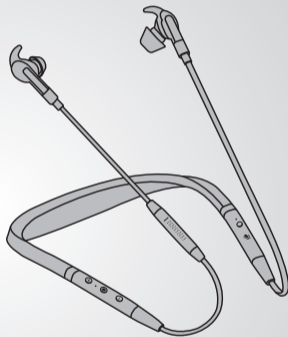

The headset and the USB dongle are pre-paired and ready for use. Press the Multi-function button to power on the headset.

Smartphone

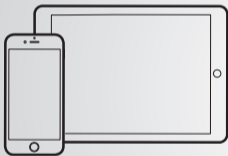

Press and hold

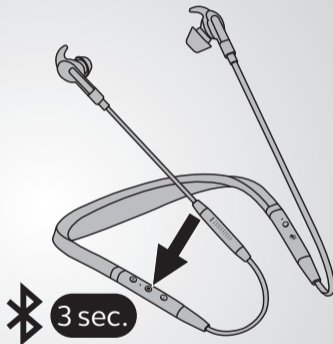

Hold the Multi-function button until the LED flashes blue, and then follow the voice-guided instructions in the headset.

How to wear

Select the correct EarGel and EarWing

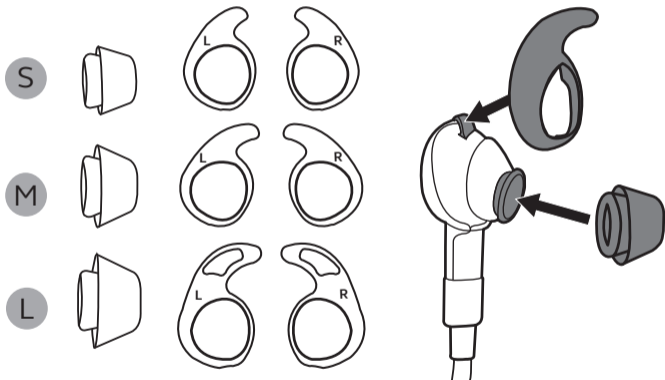

Ears come in all shapes and sizes. For optimal audio quality, mix and match the different EarGel and EarWing sizes to find the best fit for your ear.



Position the microphone close to your mouth.

How to use

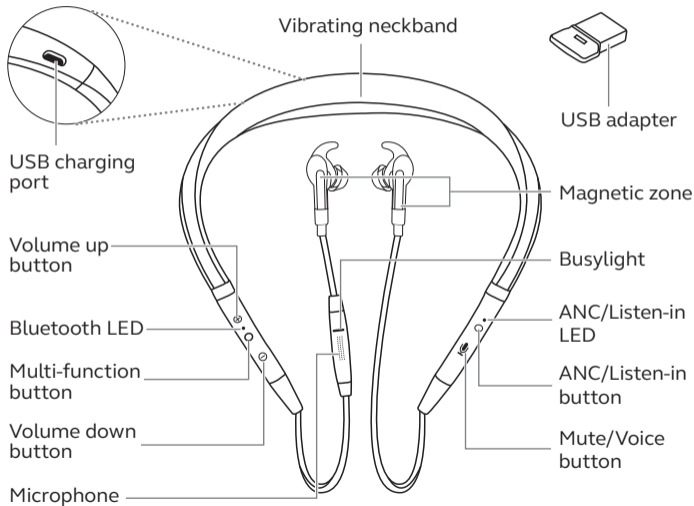

Active Noise Cancellation

Eliminate unwanted background noise by tapping the ANC button.



Listen-in

Listen-in to your surroundings without taking off your headset by pressing the Listen-in button (2 secs).



Charging

Plug the headset into a USB port on your PC or wall charger.

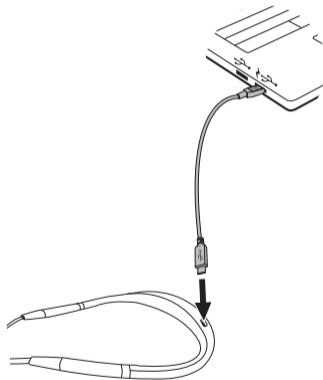

It takes approx. 2 hours to fully charge the headset.

如何连接

电脑

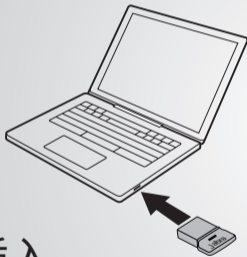

插入

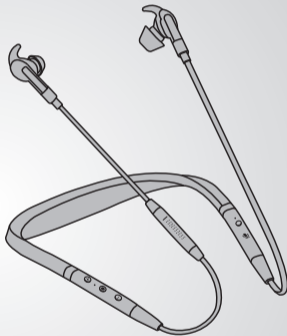

耳机和 USB 适配器经过预配对, 可供立即使用。
按多功能按钮打开耳机电源。

智能手机

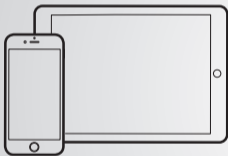

长按

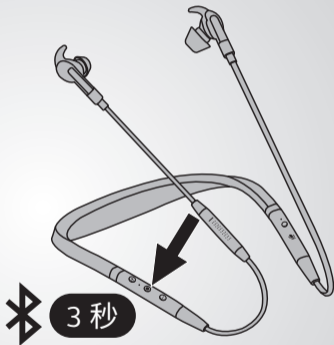

按住多功能 (Multi-function) 按钮直到 LED 指示灯闪烁蓝光, 然后按照耳机内语音提示的说明进行操作。

如何佩戴

选择正确的耳胶和耳翼

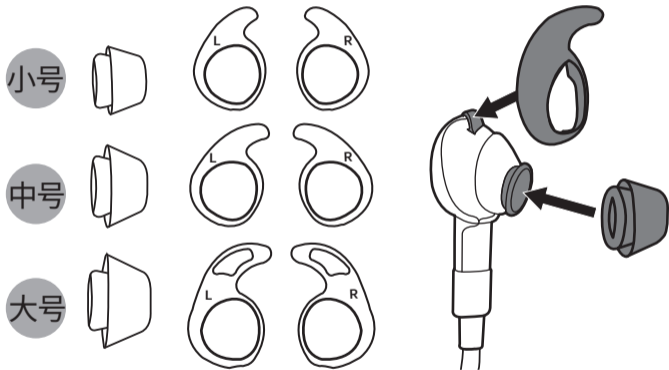

人耳的形状和大小各异。为获得最佳音质，混合搭配不同的耳胶和耳翼尺寸，以找到最适合您耳朵的尺寸。



将麦克风靠近嘴部。

如何使用

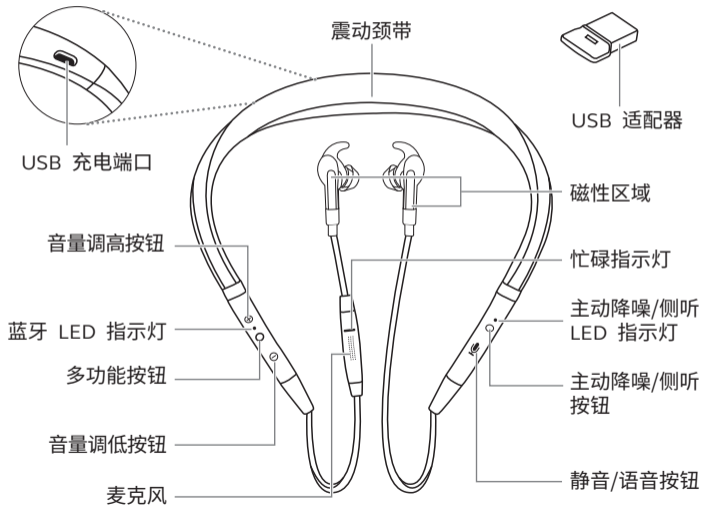

主动降噪

通过轻按主动降噪按钮消除不想要的背景噪音。



侧听

在不取下耳机的情况下，按侧听按钮 2 秒钟即可听见周围的声音。



充电

将耳机插入电脑上的 USB 端口或壁式充电器接口。

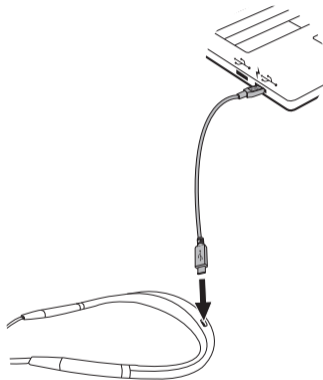

耳机完全充满电大约需要 2 小时。

如何連接

電腦

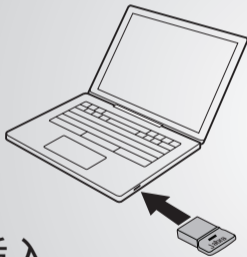

插入

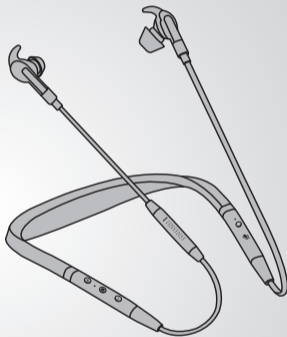

耳機與 USB 接收器已預先配對, 可立即使用。按下多功能按鈕, 即可開啟耳機電源。

智慧型手機

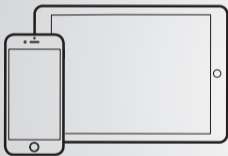

長按

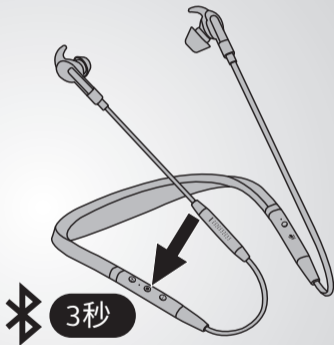

長按多功能按鈕, 直到 LED 指示燈閃爍藍光, 然後按照耳機中的語音指示操作。

如何佩戴

選擇正確的耳塞及耳翼

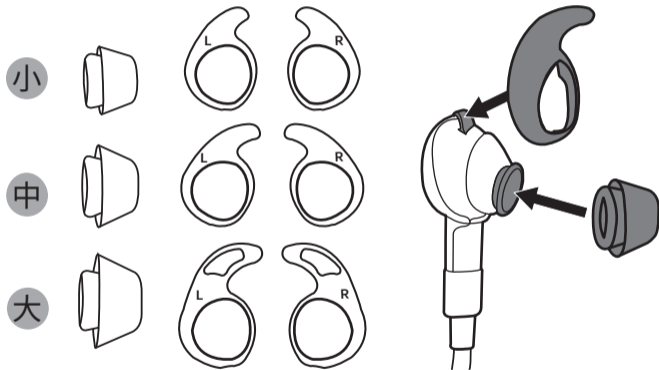

每個人的耳朵形狀和大小皆不同。為得到最佳音質，請嘗試將不同尺寸的耳塞及耳翼交叉配對，找出最適合耳朵的組合。

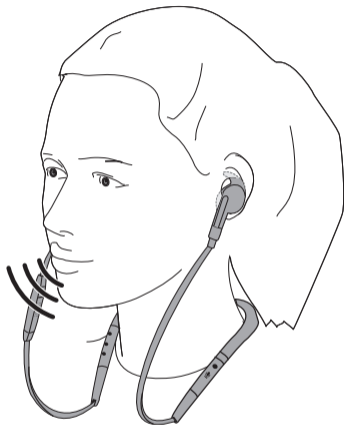

將麥克風靠嘴放置。

如何使用

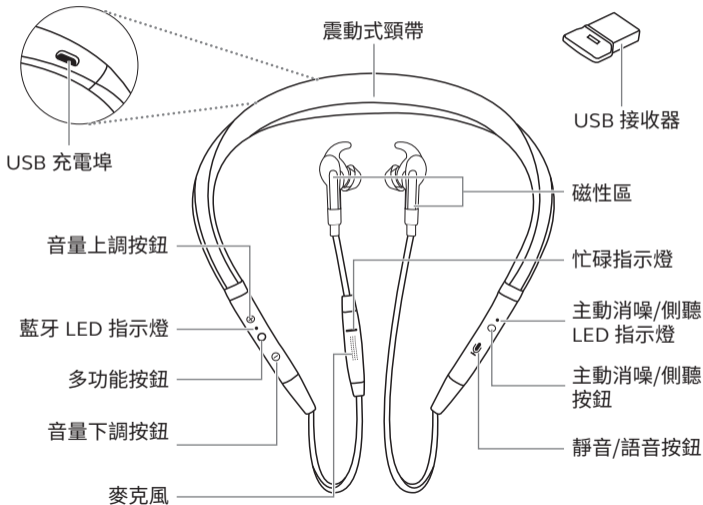

主動消噪

輕按主動消噪按鈕，可消除惱人的背景噪音。



側聽

長按側聽按鈕 2 秒，可聆聽周遭環境聲音，無需拿下耳機。



充電

插入電腦或壁式充電器上的 USB 連接埠。

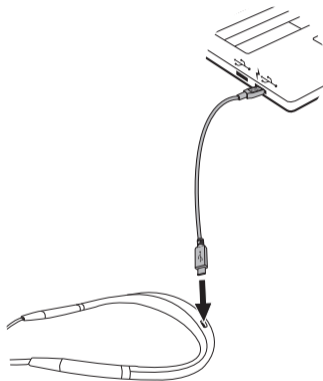

耳機充滿電約需 2 小時。

Způsob připojení

PC

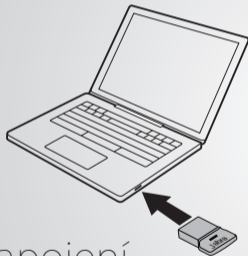

Zapojení

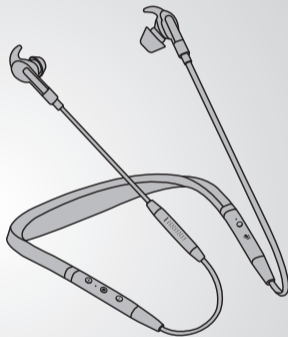

Náhlavní souprava a USB adaptér jsou předběžně spárovány a připraveny k použití. Stiskem multifunkčního tlačítka zapnete náhlavní soupravu.

Chytrý telefon

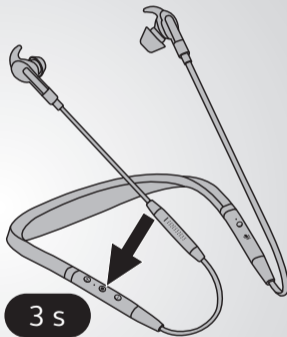
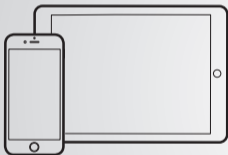

Stisknout a podržet



3 s

Přidržte multifunkční tlačítko, dokud kontrolka nezačne blikat modře a poté postupujte podle hlasových pokynů náhlavní soupravy.

Způsob nošení

Vyberte si správnou velikost gelového nástavce a raménka EarWing.

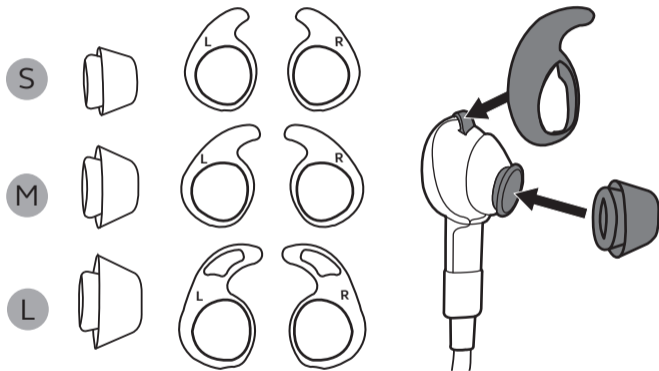

Nástavce se dodávají ve všech tvarech a velikostech. V zájmu dosažení optimální kvality zvuku zkombinujte a přizpůsobte různé velikosti gelových nástavců a ramének EarWing tak, abyste dosáhli co nejlepšího usazení a nošení.



Mikrofon umístěte blíže k ústům.

Způsob použití

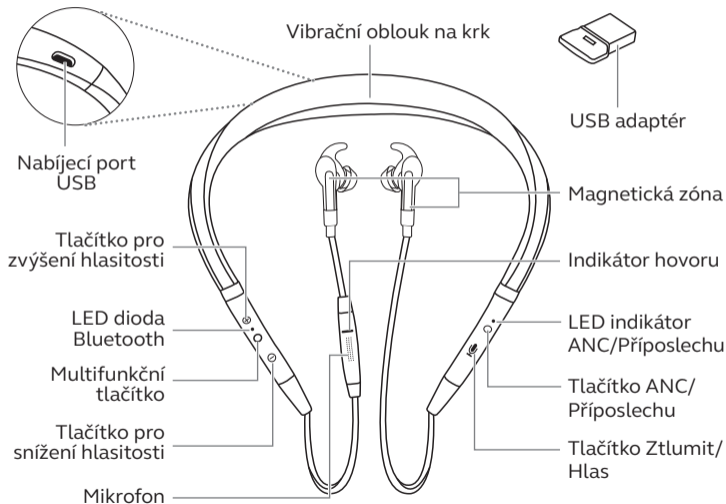

Aktivní potlačení hluku

Pomocí tlačítka ANC lze odstranit nežádoucí šum na pozadí.



Příposlech

Stiskem tlačítka Příposlech (Listen-in) na 2 sekundy je k dispozici možnost naslouchat svému okolí bez nutnosti odkládat náhlavní soupravu.



Nabíjení

Náhlavní soupravu zapojte do jakéhokoli USB portu na počítači nebo běžné nabíječky.

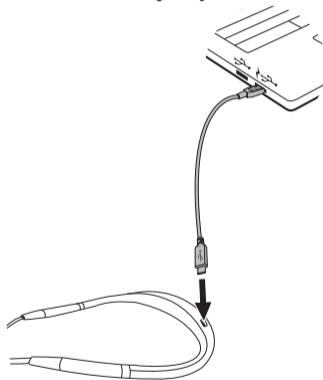

Náhlavní souprava se zcela nabije asi za 2 hodiny.

Så här ansluter du produkten PC

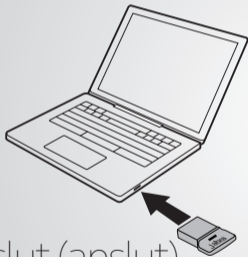

Tilslut (anslut)

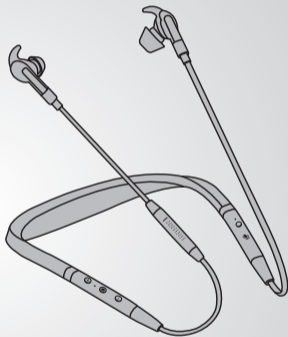

Headsettet og USB-donglen er forhåndsparret (ihopkopplade i förväg) og klar til brug (redo att användas). Tryk på multifunktionsknappen for at tænde (sätta på) for headsettet.

Smarttelefon

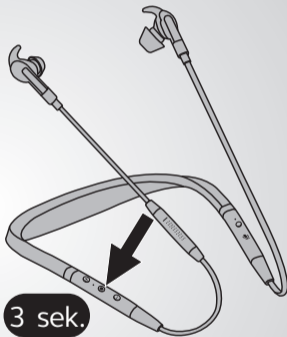
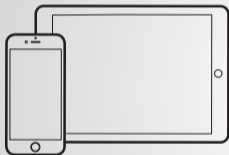

Tryk och hold (håll in)



3 sek.

Hold multifunktionsknappen nede, til LED-lampen blinker blåt, og følg så stemmevejledningen (röstguiden) i headsettet.

Så här bär du produkten

Välj den korrekta EarGel og EarWing

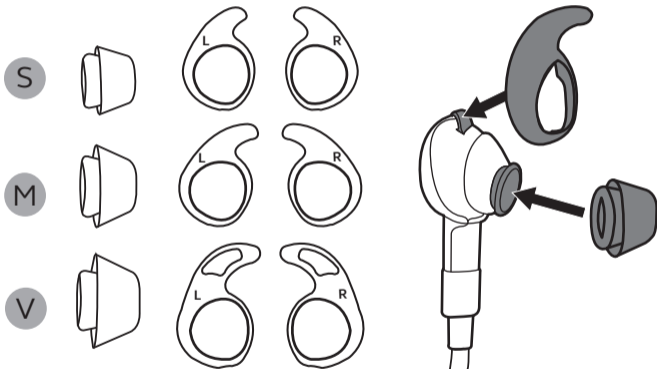

Alle ører (öron) har ikke bare én form og én størrelse (storlek). For den optimale lydqualität kan du blande de forskellige (olika) EarGel- og EarWing-størrelser for at finde den bedste (bästa) pasform til dit øre.



Placer mikrofonen tæt (nära) på din mund.

Så här använder

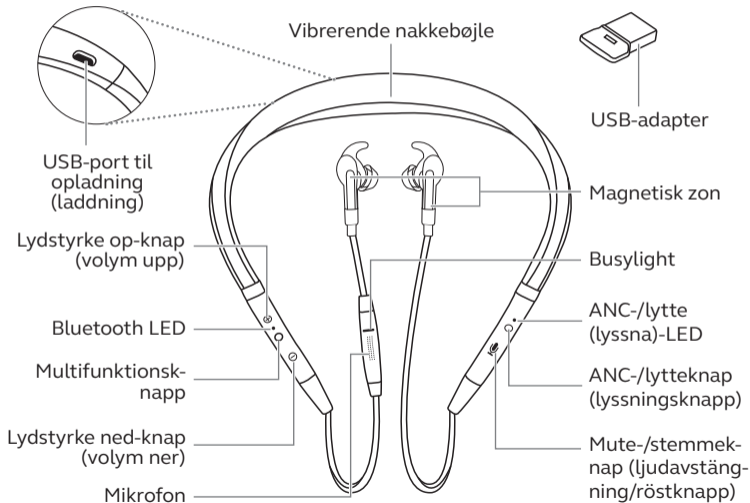

Aktiv støjdæmpning (brusreducering)

Fjern (avlægsna) uønsket baggrundsstøj (bakgrundsbrus) ved at trykke på ANC-knappen.



Lyt med (lyssna)

Lyt (lyssna) til dine omgivelser uden at tage headsettet af ved at trykke på lytteknappen (lyssningsknappen) (2 sek.).



Laddning

Sæt headsettet i en USB-port på pc'en (datoren) eller vægopladeren (väggladdaren).

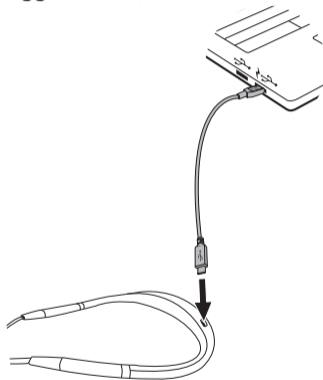

Det tager ca. 2 timer at lade (fulladda) headsettet helt op.

Verbinden

PC

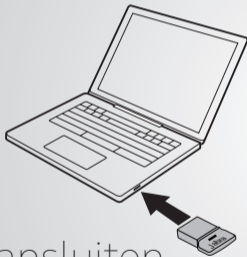

Aansluiten

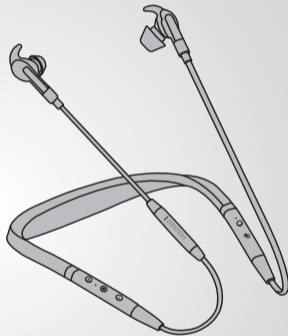

De headset en de USB-dongle zijn standaard gekoppeld en klaar voor gebruik. Druk op de Multifunctionele toets om de headset aan te zetten.

Smartphone

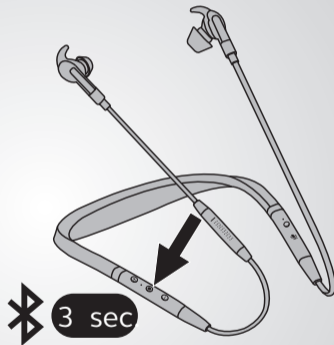
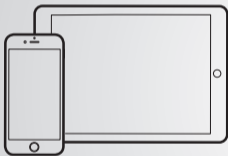

Ingedrukt houden

Houd de Multifunctionele toets ingedrukt totdat het indicatielampje blauw knippert en volg de gesproken instructies in de headset.

Dragen

Kies de juiste EarGel en EarWing

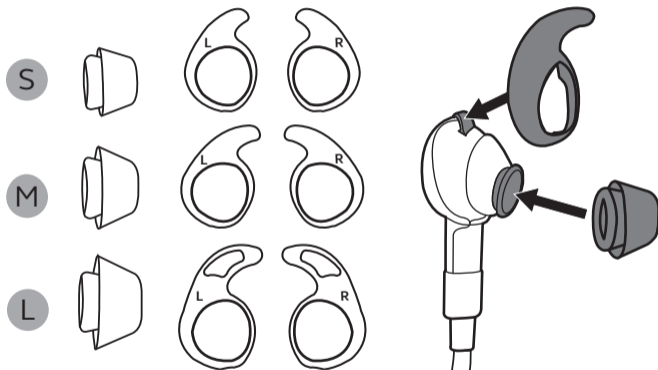

Elk oor is anders. Voor de optimale geluidskwaliteit moet u verschillende maten EarGels en EarWings combineren om te ontdekken welke combinatie het beste in uw oor past.



Plaats de microfoon precies voor uw mond.

Gebruiken

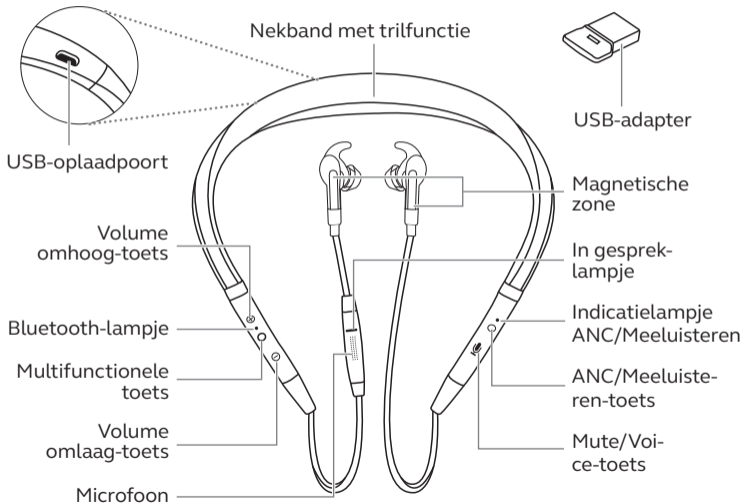

Active Noise Cancellation

Elimineer ongewenst achtergrondgeluid door op de ANC-toets te tikken.



Meeluisteren

Luister mee met uw omgeving zonder uw headset af te zetten door de Meeluisteren-toets 2 seconden ingedrukt te houden.



Opladen

Steek de headset in een USB-poort van uw computer of adapter.

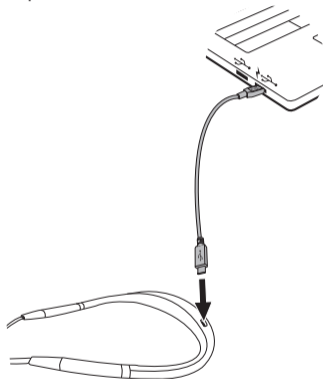

Het duurt ongeveer 2 uur om de headset volledig op te laden.

Instructions de connexion

PC

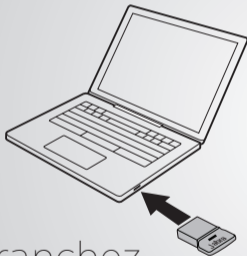

Branchez

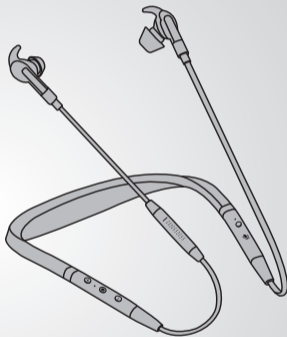

Le micro-casque et la clé USB sont pré-appairés et prêts à l'emploi. Appuyez sur le bouton Multifonction pour mettre le micro-casque sous tension.

Smartphone

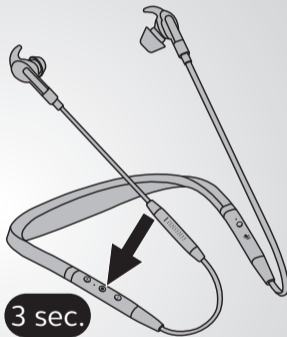
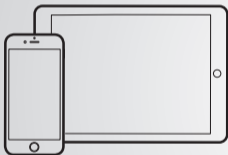

Maintenez appuyé



3 sec.

Maintenez le bouton Multifonction enfoncé jusqu'à ce que la LED clignote en bleu, puis suivez les instructions vocales dans le micro-casque.

Instructions de port

Sélectionnez l'EarGel et l'EarWing appropriés

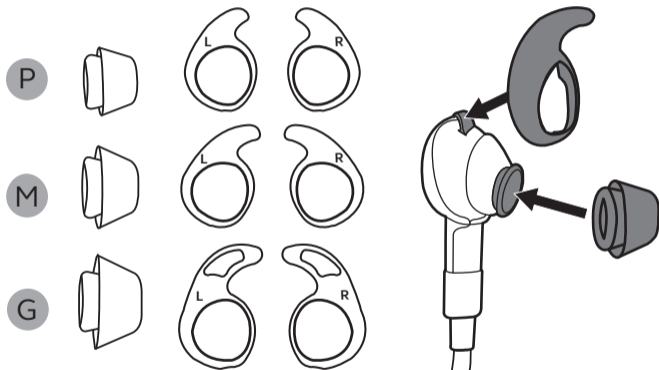

Les oreilles sont de toutes les formes et de toutes les tailles. Pour une qualité audio optimale, testez les différentes tailles d'EarGel et d'EarWing pour trouver le meilleur ajustement pour votre oreille.



Placez le micro près de votre bouche.

Instructions d'utilisation

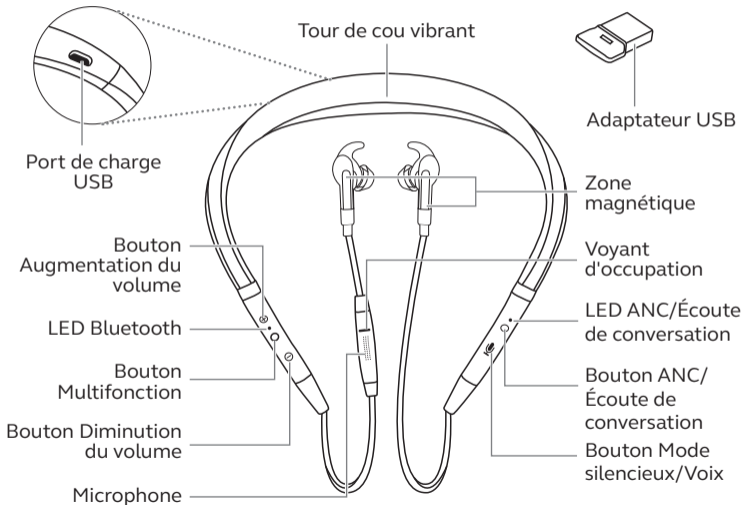

Réduction active du bruit

Éliminez le bruit de fond indésirable en appuyant sur le bouton ANC.

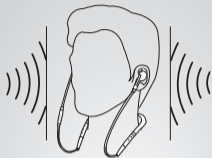

Écoute de conversation

Écoutez les sons qui vous entourent sans retirer votre micro-casque en appuyant sur le bouton Écoute de conversation (2 secondes).



Charge

Branchez le micro-casque à un port USB de votre PC ou chargeur mural.

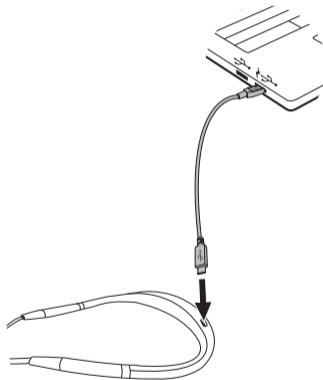

Comptez environ 2 heures pour une recharge complète.

Comment le connecter

PC

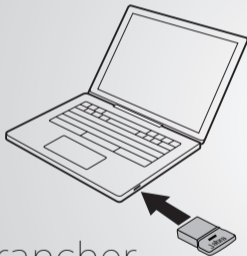

Brancher

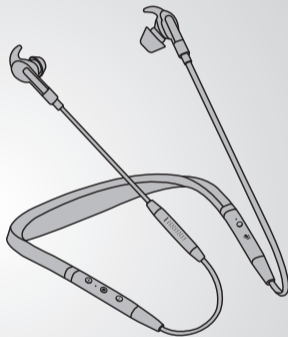

Le casque et la clé USB sont précouplés et peuvent être immédiatement utilisés. Appuyez sur le bouton multifonction pour alimenter le casque.

Téléphone intelligent

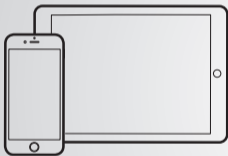

Appuyer
et maintenir

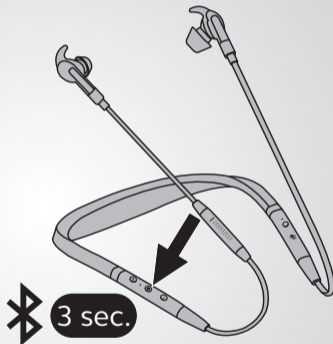

Maintenez le bouton multifonction appuyé jusqu'à ce que le voyant bleu clignote, puis suivez les instructions vocales dans le casque.

Comment le porter

Sélectionner la taille correcte d'embout EarGel et d'adaptateur EarWing

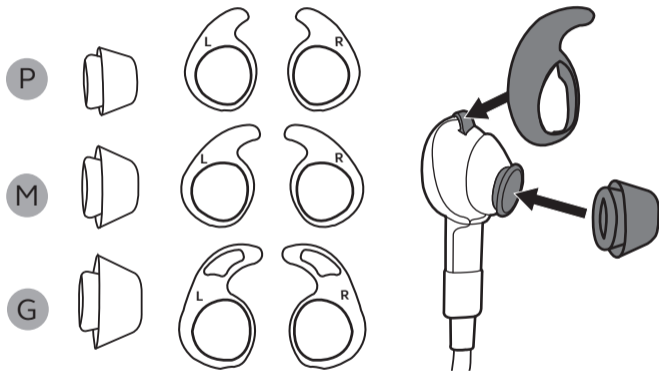

Les embouts et adaptateurs sont proposés dans différentes formes et tailles. Pour une qualité audio optimale, mélangez et faites correspondre les différentes tailles d'embout EarGel et d'adaptateur EarWing pour trouver ceux qui s'adaptent le mieux à votre oreille.



Placez le micro à proximité de votre bouche.

Comment l'utiliser

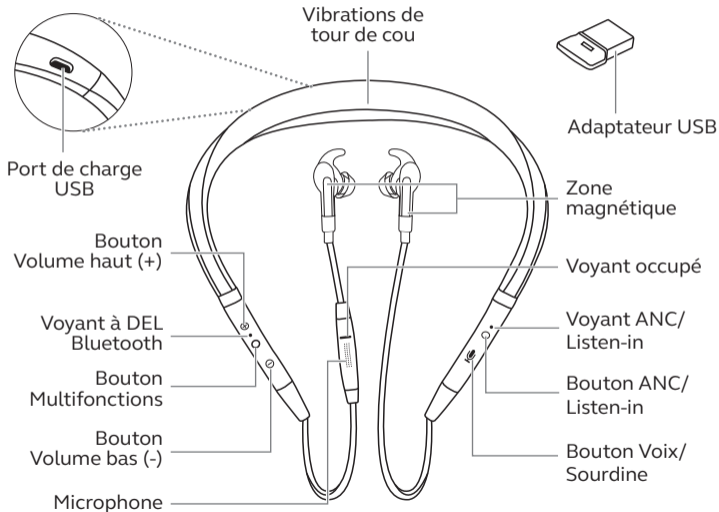

Suppression du bruit

Éliminez le bruit de fond indésirable en appuyant sur le bouton ANC.

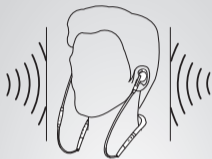

Écouter

Écoutez votre entourage sans enlever votre casque mais simplement en appuyant sur le bouton Listen-in (2 secondes).



Charge

Branchez le casque dans le port USB de votre PC ou du chargeur mural.

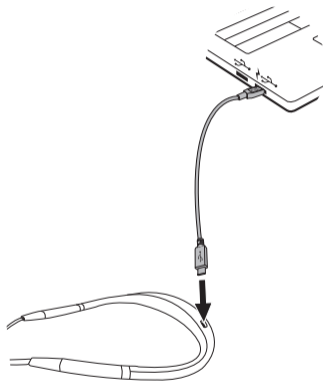

Une pile prend environ 2 heures pour se charger complètement.

Verbindung herstellen

Mit dem PC

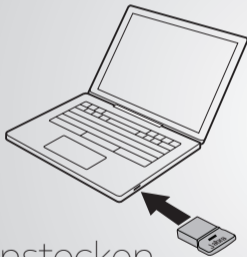

Einstecken

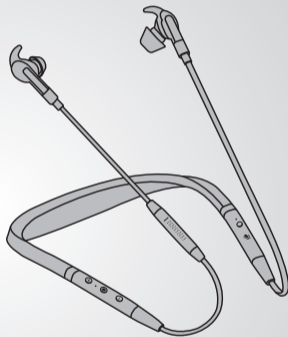

Das Headset und der USB-Dongle sind vorab gekoppelt und betriebsbereit. Drücken Sie die Multifunktionstaste, um das Headset einzuschalten.

Mit dem Smartphone

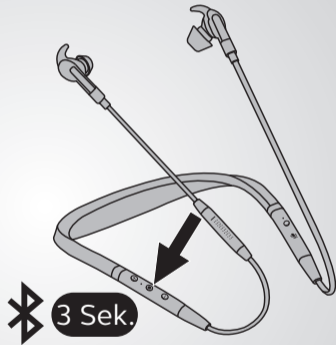
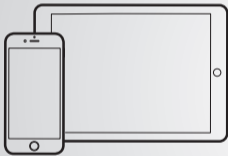

Drücken und halten

Halten Sie die Multifunktionstaste am Headset gedrückt, bis die LED-Anzeige blau blinkt und folgen Sie danach den sprachgeführten Anweisungen.

Tragestil

Wählen Sie das passende earGel und earWing

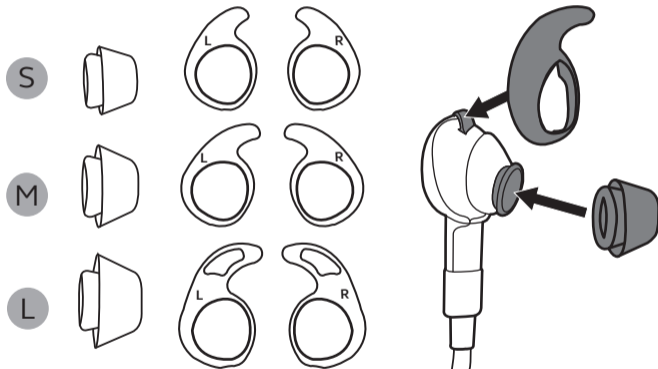

Das menschliche Ohr hat die verschiedensten Formen und Größen. Um die optimale Klangqualität zu erhalten, probieren Sie verschiedene Kombinationen aus, bis Sie die optimale Passform gefunden haben.



Tragen Sie das Mikrofon in geringem Abstand zum Mund.

Verwendung

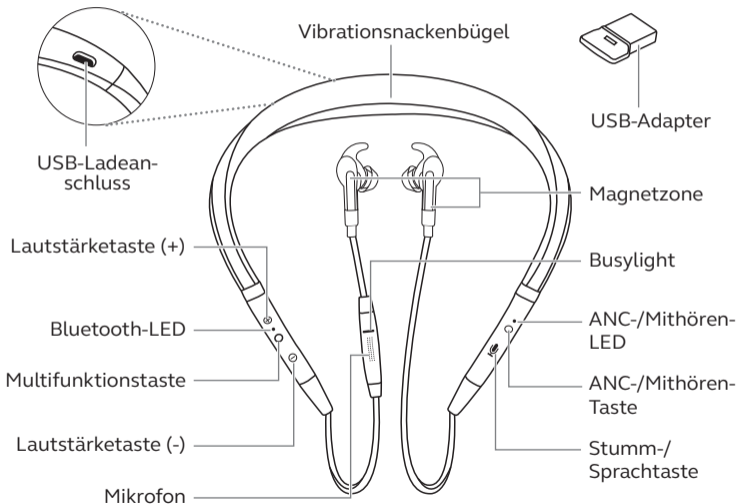

Aktive Geräusch- unterdrückung (ANC)

Beseitigung unerwünschter
Hintergrundgeräusche per
Tastendruck auf die ANC-Taste.

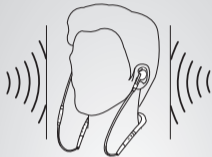

Mithören

Ein Druck auf die Mithörtaste
(2 Sek.) ermöglicht es Ihnen, Ihre
Umgebung zu hören, ohne das
Headset abnehmen zu müssen.



Aufladen

Verbinden Sie das Headset mit
dem USB-Port Ihres PC oder dem
Netzladegerät.

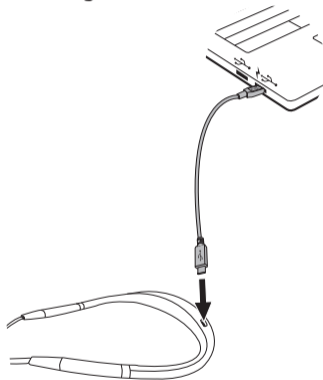

Nach ca. 2 Stunden ist das
Headset vollständig geladen.

Come connetterli

PC

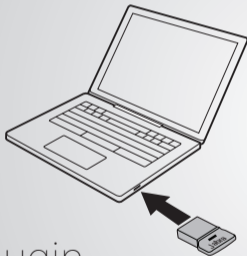

Plugin

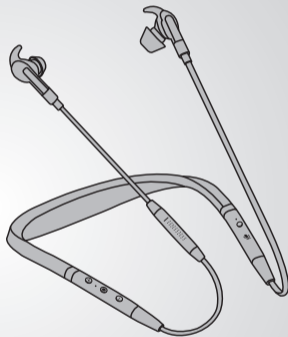

Gli auricolari e il dongle USB sono preaccoppiati e pronti per l'uso.
Premi il tasto Multifunzione per accendere gli auricolari.

Smartphone

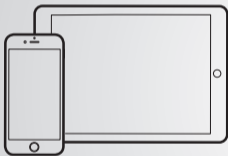

Tieni premuto

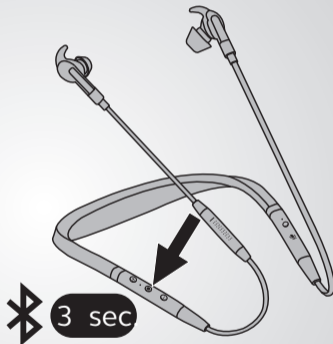

Tieni premuto il tasto Multifunzione fino a quando il LED non lampeggia in blu e poi segui le istruzioni vocali negli auricolari.

Come indossarli

Seleziona l'EarGel e l'EarWing corretti

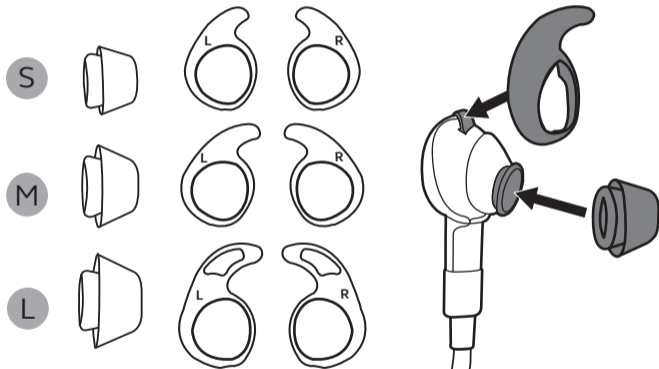

Le orecchie possono avere un sacco di forme e dimensioni diverse. Per una qualità audio ottimale, prova le varie dimensioni di EarGel ed EarWing per trovare quella che si adatta meglio alle tue orecchie.



Posiziona il microfono vicino alla bocca.

Come utilizzarli

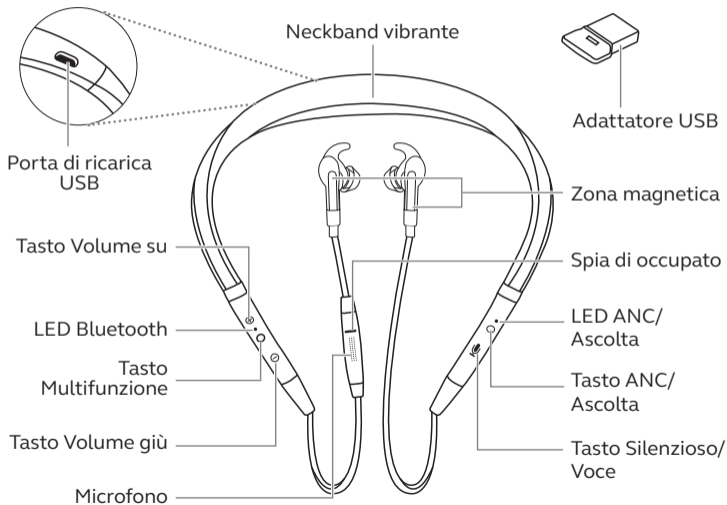

Cancellazione attiva del rumore

Elimina il rumore di sottofondo indesiderato sfiorando il tasto ANC.



Ascolta

Ascolta l'ambiente che ti circonda senza toglierti gli auricolari premendo per due secondi il tasto Ascolta.



Ricarica

Collega gli auricolari a una qualsiasi porta USB sul PC o a un caricabatteria a parete.

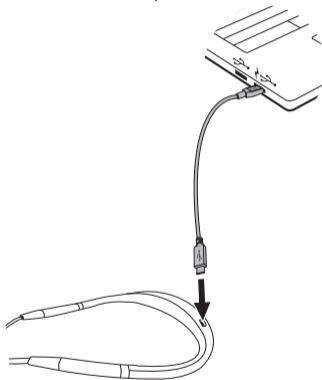

Sono necessarie circa due ore per caricare completamente gli auricolari.

ペアリング方法

PC

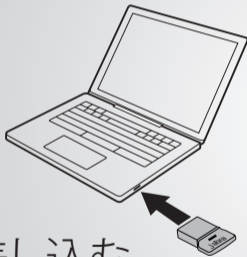

差し込む

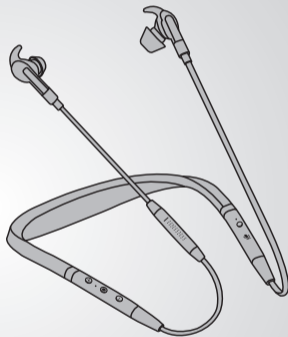

ヘッドセットとUSB ドングルは事前にペアリングされ、使用準備ができています。多機能 (Multi-function) ボタンを押してヘッドセットの電源をオンにします。

スマートフォン

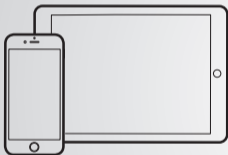

押し続ける

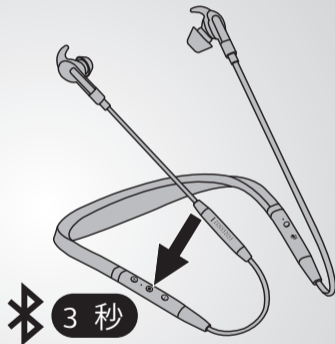

LED が青に点滅するまで多機能 (Multi-function) ボタンを押し続けて、ヘッドセットの、音声ガイダンスの指示に従います。

装着方法

正しいイヤージェルとイヤークリップの選択

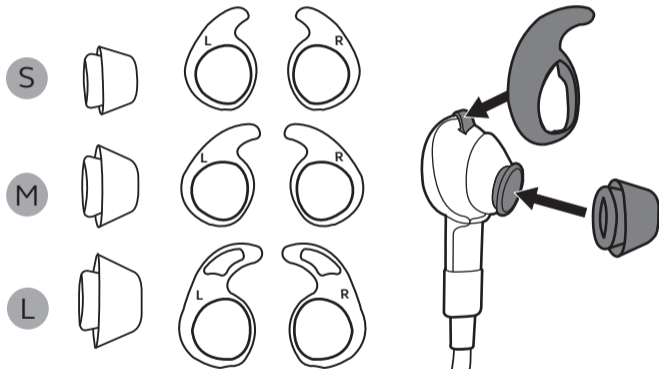

耳の形やサイズはそれぞれ異なります。最適な音質を得るため、異なるイヤージェルとイヤークリップのサイズを試して、耳にぴったりなものを探してください。



マイクを口元に近づけます。

使用方法

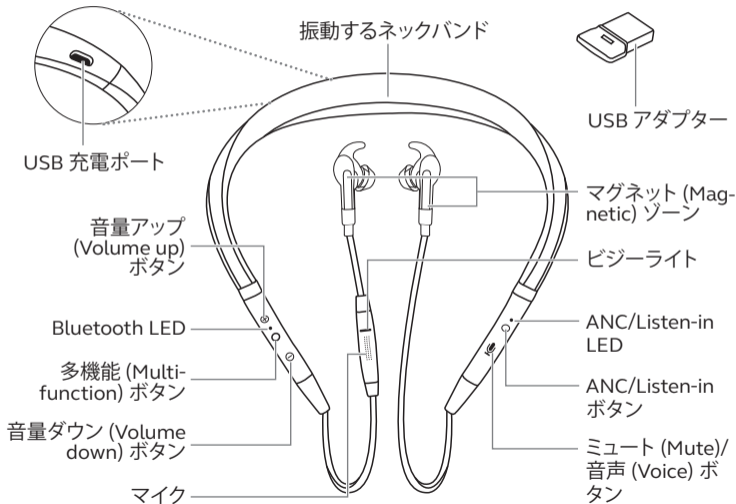

アクティブノイズキャンセリング

ANC ボタンをタップして不要な周囲のノイズを消去します。



Listen-in

Listen-in ボタンを (2 秒間) 押してヘッドセットを外すことなく、周りの音を聞きます。



充電する

PC の USB ポートまたは充電器にヘッドセットを接続します。

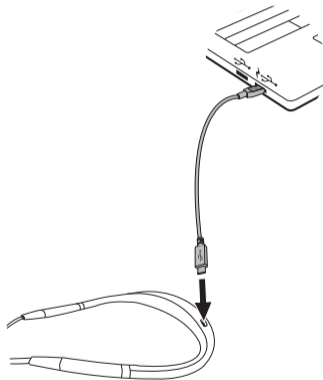

ヘッドセットをフル充電するには約 2 時間かかります。

연결 방법

PC



플러그인

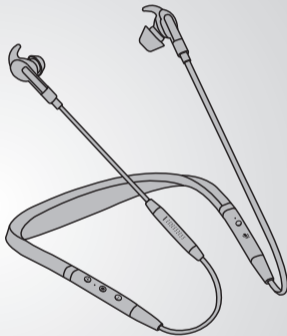

헤드셋과 USB 동글은 이미 페어링되어 있으며 바로 사용할 수 있습니다. 헤드셋을 켜는 동시에 다기능(Multi-function) 버튼을 눌러서 전원을 켭니다.

스마트폰

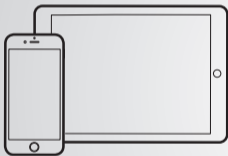

누른 상태로 유지

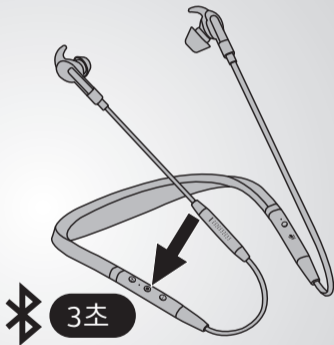

LED가 파란색으로 점멸할 때까지 다기능(Multi-function) 버튼을 길게 누르고 있고, 그 다음에 헤드셋의 음성 안내를 따르십시오.

착용 방법

올바른 EarGel 및 EarWing 선택:

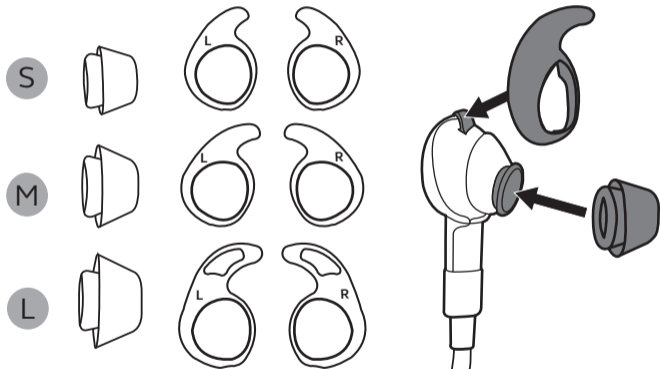

귀는 다양한 크기와 모양이 있습니다. 최적의 음질을 위해 서로 다른 크기의 EarGel과 EarWing을 혼합하여 사용하고, 귀에 가장 적합한 피팅을 찾아보십시오.



마이크를 입에 가까이 댑니다.

사용 방법

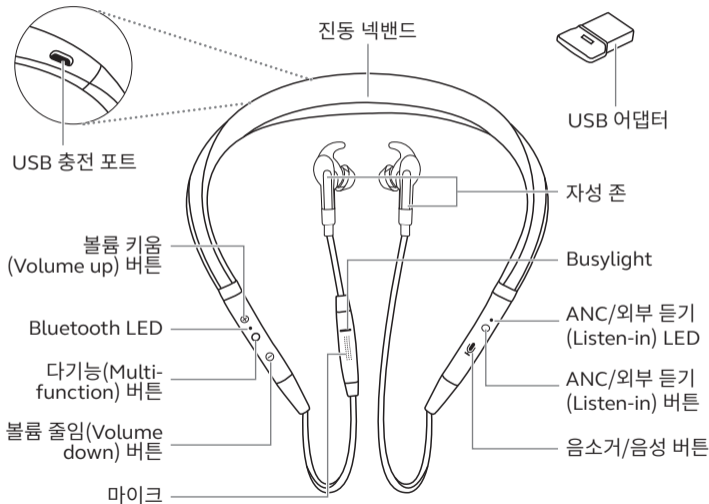

Active Noise Cancellation

ANC 버튼을 눌러서 원하지 않는 배경 소음을 줄입니다.



외부 듣기

외부 듣기(Listen-in) 버튼을 길게 눌러서 헤드셋을 벗지 않은 채 주위 소리를 들읍니다(2초).



충전

헤드셋을 컴퓨터 USB 포트 또는 전원 충전기에 연결합니다.

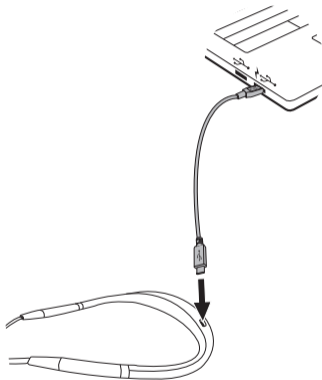

헤드셋을 완전히 충전하는 데에는 약 2 시간이 걸립니다.

Podłączanie

Komputer

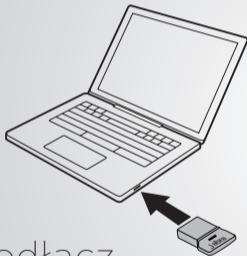

Podłącz

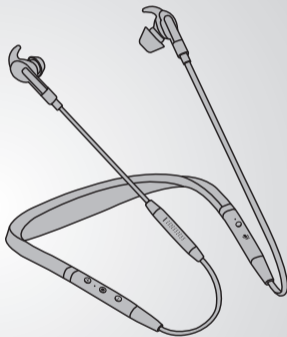

Zestaw słuchawkowy i klucz sprzętowy USB są już sparowane i gotowe do użytku. Naciśnij przycisk wielofunkcyjny, aby włączyć zestaw słuchawkowy.

Smartfon

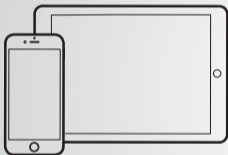

Naciśnij i
przytrzymaj

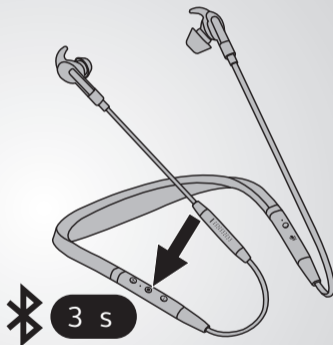

Przytrzymaj przycisk wielofunkcyjny aż dioda LED zacznie błyskać na niebiesko, a następnie wykonuj polecenia głosowe emitowane przez zestaw słuchawkowy.

Sposób noszenia

Wybierz odpowiednie wkładki do ucha EarGel i zaczep EarWing

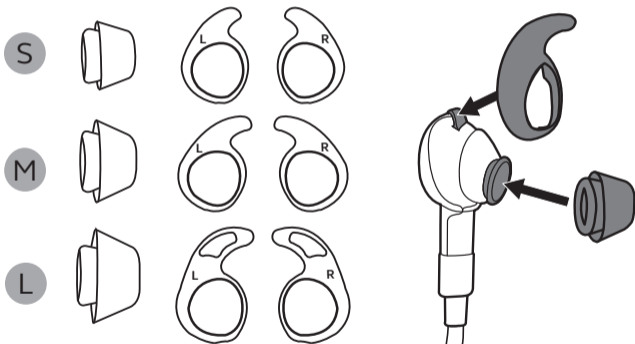

Uszy mają różną wielkość i kształt. Aby uzyskać optymalną jakość dźwięku, należy odpowiednio dobrać rozmiary wkładek do ucha i zaczepów, aby dopasować je do ucha.



Ustaw mikrofon blisko ust.

Obsługa

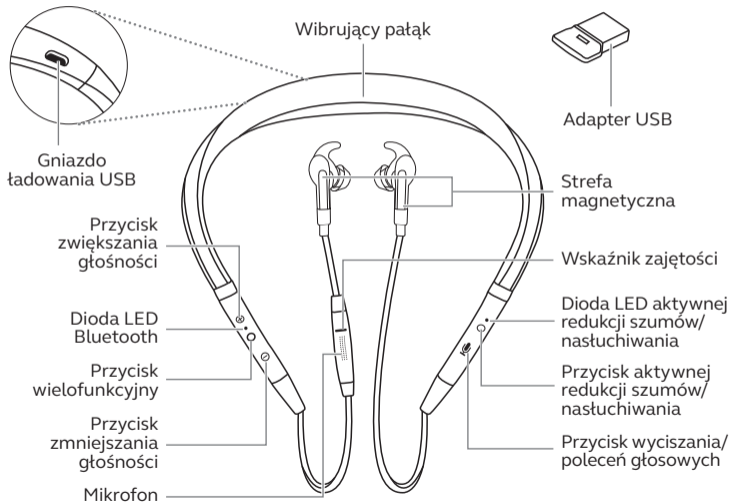

Aktywna redukcja szumów (ANC)

Usuń niepożądane dźwięki otoczenia, dotykając przycisku ANC.



Nastłuchiwanie

Słuchaj dźwięków otoczenia, nie zdejmując zestawu słuchawkowego po naciśnięciu (na 2 s) przycisku nastłuchiwania.



Ładowanie

Podłącz zestaw słuchawkowy do gniazda USB komputera lub ładowarki sieciowej.

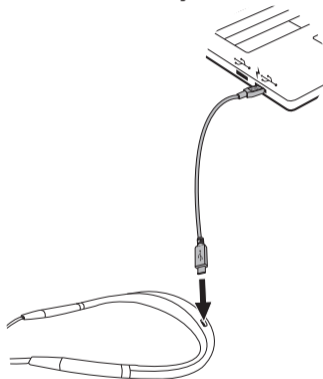

Całkowity czas ładowania zestawu słuchawkowego wynosi ok. 2 godz.

Como ligar

PC

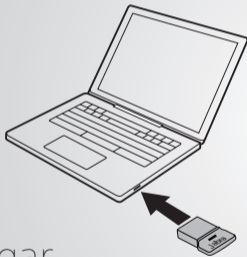

Ligar

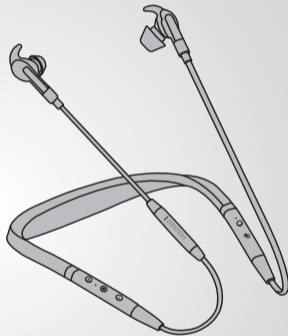

O auscultador e o dongle USB estão pré-emparelhados e prontos a usar. Prima o botão Multifunções para ligar o auscultador.

Smartphone

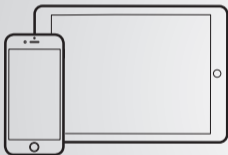

Prima e mantenha
premido



3 seg

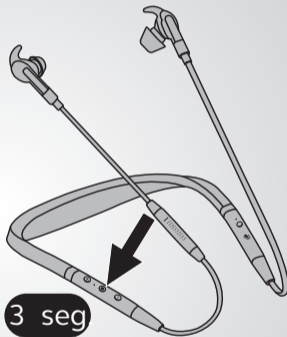

Mantenha o botão Multifunções premido até o LED assumir a cor azul intermitente e depois siga as instruções orientadas por voz do auscultador.

Como usar

Selecione o EarGel e EarWing corretos

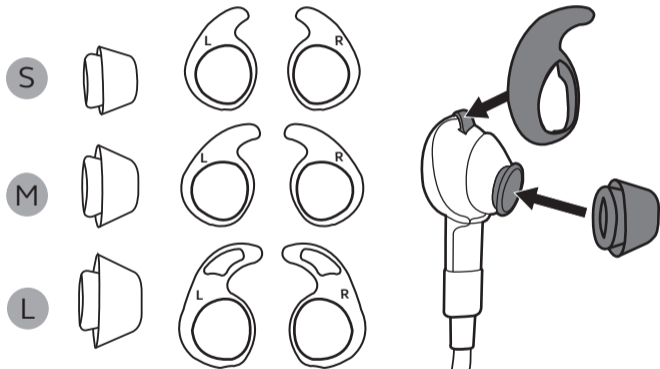

Os ouvidos assumem todas as formas e tamanhos. Para uma ótima qualidade de áudio, use os diferentes tipos de EarGel e EarWing para encontrar o melhor ajuste para o seu ouvido.



Posicione o microfone próximo da sua boca.

Como utilizar

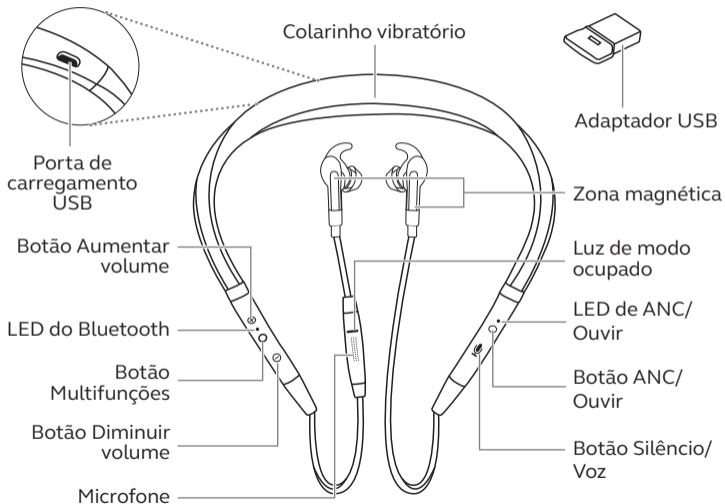

Eliminação de ruído ativa

Elimine ruídos de fundo indesejados ao tocar no botão ANC.



Ouvir

Ouça o que o rodeia sem retirar os auscultadores ao premir o botão Ouvir (2 seg).



Carregar

Ligue o auscultador à porta de USB do seu PC ou carregador de parede.

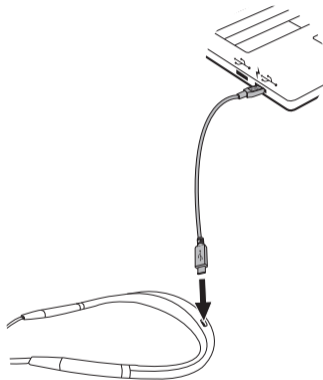

São necessárias aprox. 2 horas para carregar totalmente os auscultadores.

Como conectar

PC

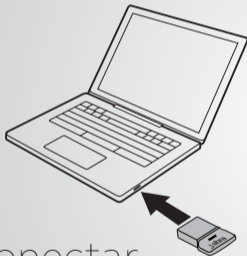

Conectar

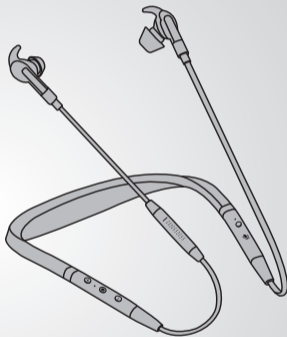

O headset e o dongle USB são pré-pareados e prontos para usar. Pressione o botão Multifuncional para ligar o headset.

Smartphone

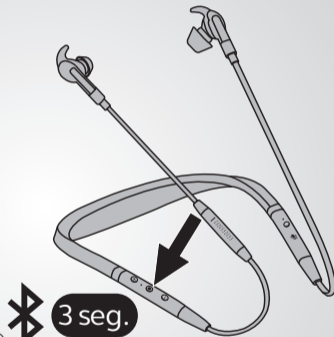
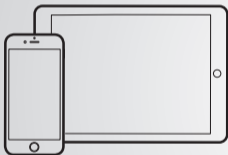

Pressione e segure

Segure o botão Multifuncional até o LED piscar em azul, depois siga as instruções orientadas por voz no headset.

Como usar

Selecione o EarGel e EarWing correto

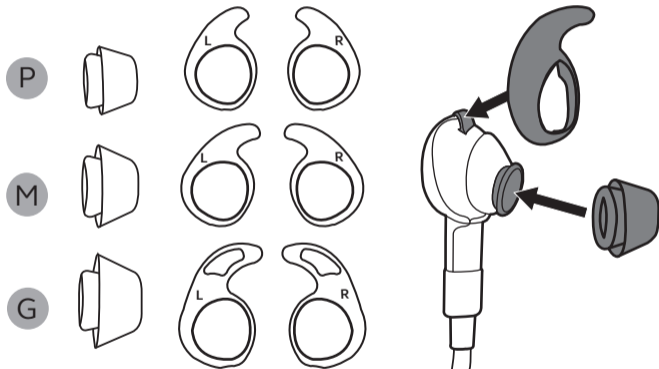

Os géis vêm em todas as formas e tamanhos. Para uma qualidade de áudio ótima, misture e combine diferentes tamanhos de EarGel e EarWing para encontrar o melhor ajuste para a sua orelha.



Posizione o microfone perto da sua boca.

Como usar

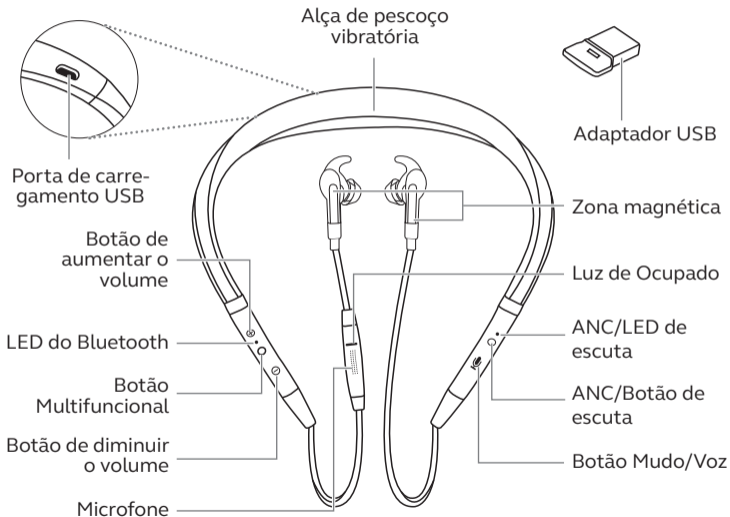

Cancelamento de ruído ativo

Elimine o ruído de fundo indesejado tocando no botão ANC.



Escutar

Escuta o que está ao seu redor sem tirar o seu headset pressionando o botão Escuta (2 segundos).



Carregando

Conecte o headset numa porta USB no seu PC ou carregador de parede.

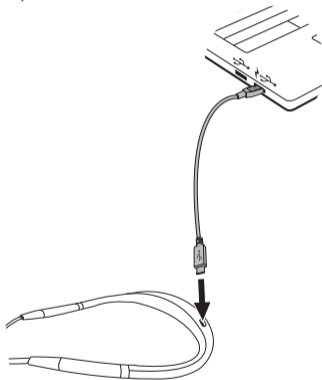

Leva aproximadamente 2 horas para carregar completamente o headset.

Подключение

ПК

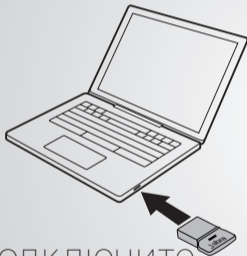

Подключите

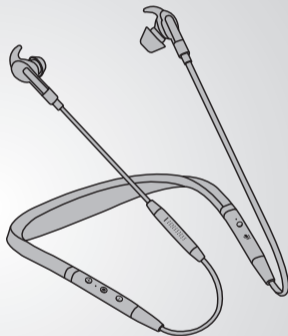

Гарнитура и USB-адаптер предварительно сопряжены и готовы к использованию. Нажмите многофункциональную кнопку, чтобы включить гарнитуру.

Смартфон

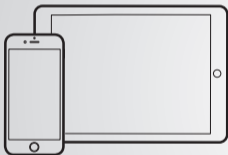

Нажмите и
удерживайте

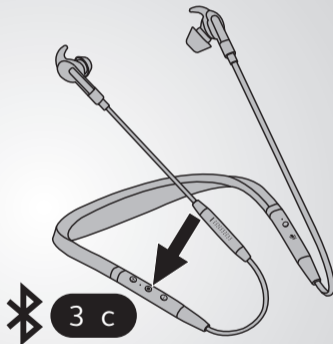

Удерживайте многофункциональную кнопку, пока светодиодный индикатор не начнет мигать синим, и затем следуйте голосовым указаниям в гарнитуре.

Способы ношения

Выберите правильный размер силиконового ушного вкладыша или насадки

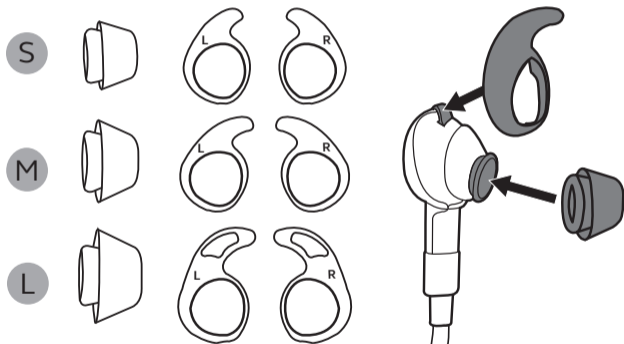

Размер и форма ушной раковины индивидуальны. Для получения оптимального качества звука подберите такой размер силиконового ушного вкладыша и насадки, который лучше всего подходит Вам.

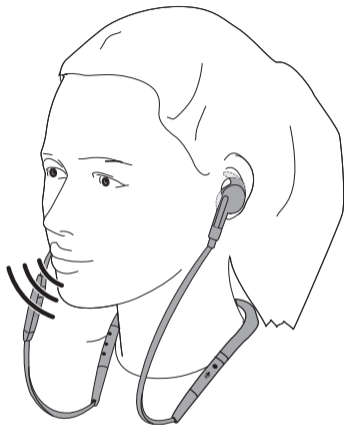

Расположите микрофон как можно ближе ко рту.

Использование



Активное шумоподавление

Уберите нежелательный фоновый шум, нажав на кнопку Активное шумоподавление.



Прослушивание окружающих звуков

Слушайте все, что происходит вокруг, без снятия гарнитуры, нажав на кнопку Прослушивание окружающих звуков (2 секунды).



Зарядка

Подключите гарнитуру к USB-разъему на ПК или к сетевому зарядному устройству.

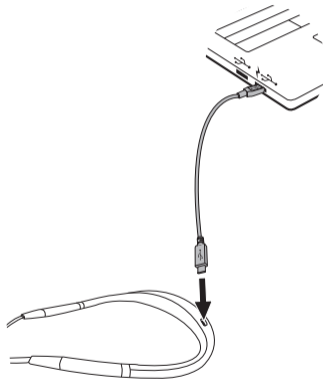

Для полной зарядки гарнитуры понадобится около 2 часов.

Cómo se conecta

PC

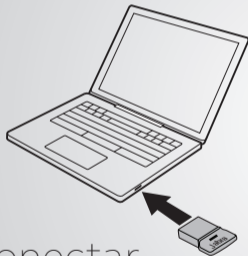

Conectar

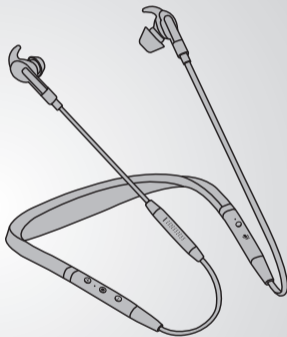

El auricular y la llave USB están presincronizados y listos para usar.
Pulse el botón Multifunción para activar el auricular.

Smartphone

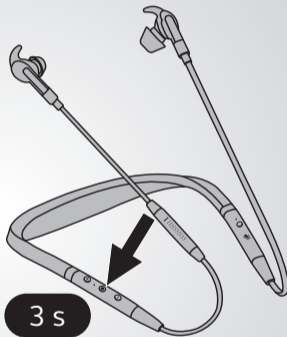
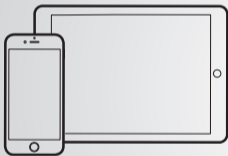

Mantenga pulsado



3 s

Mantenga pulsado el botón Multifunción hasta que el LED parpadee en azul y siga las instrucciones de voz del auricular.

Cómo se coloca

Seleccione los EarGel y los EarWing adecuados

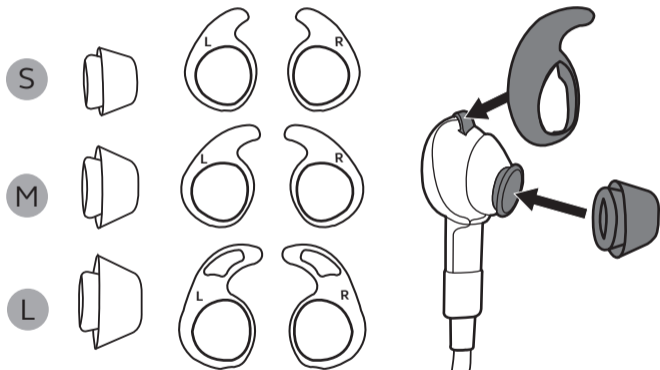

Hay orejas de todas las formas y tamaños. Para disfrutar de la mejor calidad de sonido, combine los diferentes tamaños de EarGel y de EarWing hasta encontrar el mejor ajuste.



Coloque el micrófono cerca de la boca.

Cómo se usa

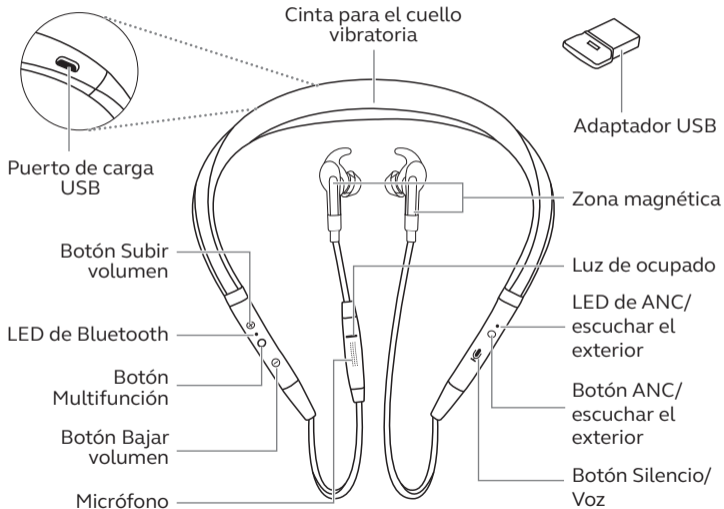

Cancelación de ruido activa (ANC)

Elimine el ruido de fondo no deseado tocando el botón ANC.



Escuchar el exterior

Para escuchar su entorno sin quitarse los auriculares, pulse el botón Escuchar el exterior durante 2 segundos.



Carga

Conecte el auricular a cualquier puerto USB de su ordenador o a un cargador de pared.

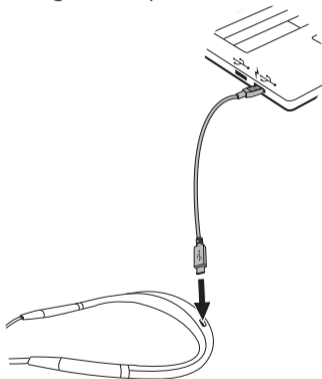

Se tarda aproximadamente 2 horas en cargar completamente los auriculares.

Cómo conectarlo

PC

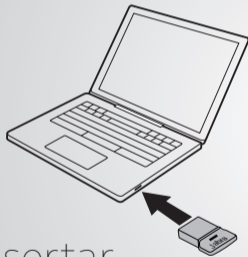

Insertar

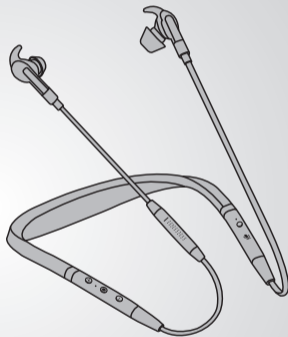

El auricular y la llave electrónica USB están pre-sincronizados y listos para usarse. Presione el botón multifuncional para encender el auricular.

Teléfono inteligente

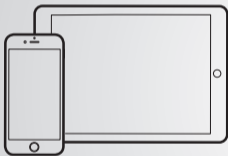

Mantenga
presionado

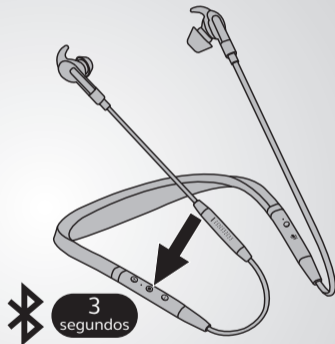

Mantenga el botón multifuncional presionado hasta que el indicador LED parpadee en color azul, y después siga las instrucciones de voz en el auricular.

Cómo usarlo

Elija el EarGel y las aletas de calce correctas

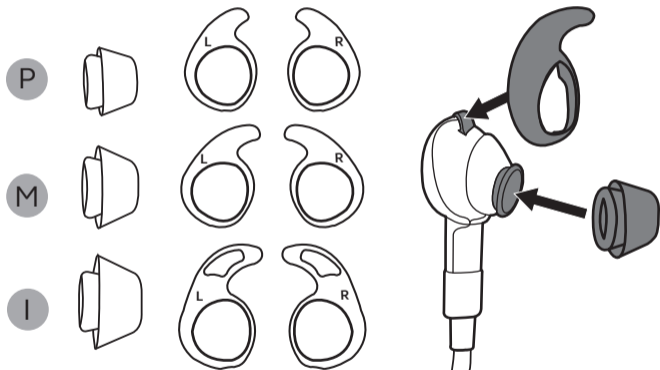

Hay variedad de formas y tamaños de oídos. Para una calidad de sonido óptima, mezcle los diferentes tamaños de EarGel y aletas de calce para encontrar el que se ajuste mejor en su oído.



Coloque el micrófono cerca de su boca

Cómo utilizarlo

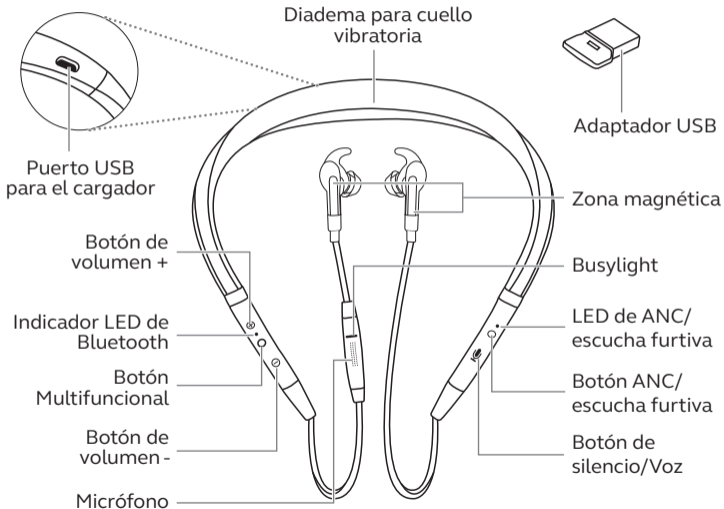

Cancelación activa de ruido

Elimine el ruido no deseado a su alrededor pulsando el botón ANC.



Escucha furtiva

Escuche a su alrededor sin quitarse el auricular pulsando el botón Escucha furtiva (2 segundos).



Carga

Conecte el auricular en un puerto USB en su PC o un cargador de pared.

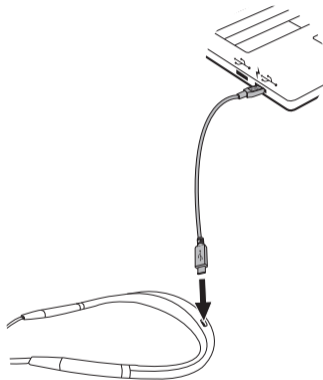

Lleva aproximadamente 2 horas cargar la batería del auricular por completo.

Baęlantı kurma

PC

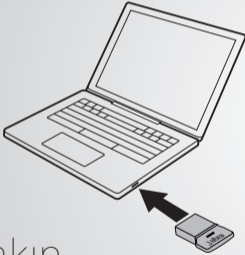

Takın

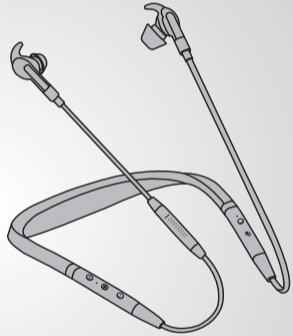

Kulaklık ve USB adaptörü eşleřtirilmiř ve kullanıma hazır olarak gelir.
Kulaklıktaki ok fonksiyonlu dğmeye basın.

Akıllı telefon

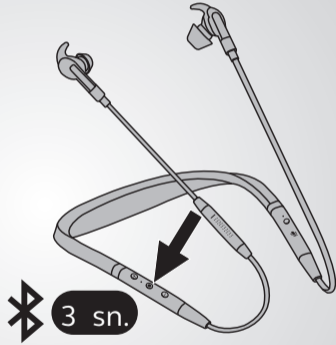
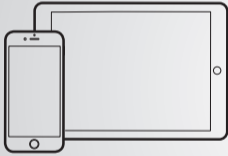

Basın ve basılı tutun

Çok fonksiyonlu düğmeyi, LED mavi renkte yanıp sönmeye başlayana kadar basılı tutun ve ardından kulaklıktan sesli olarak verilen talimatları izleyin.

Takma şekli

Doğru EarGel'i ve EarWing'i seçin

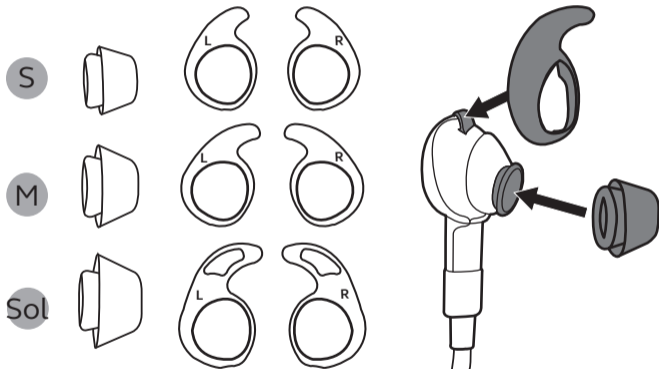

Herkesin kulağı bir diğerinden farklıdır. Optimum ses kalitesini elde etmek için, çeşitli ebatlardaki EarGel ve EarWing'leri deneyin ve kulağınıza en uygun olanları kullanın.



Mikrofonu ağızınıza yakın duracak şekilde konumlandırın.

Kullanım

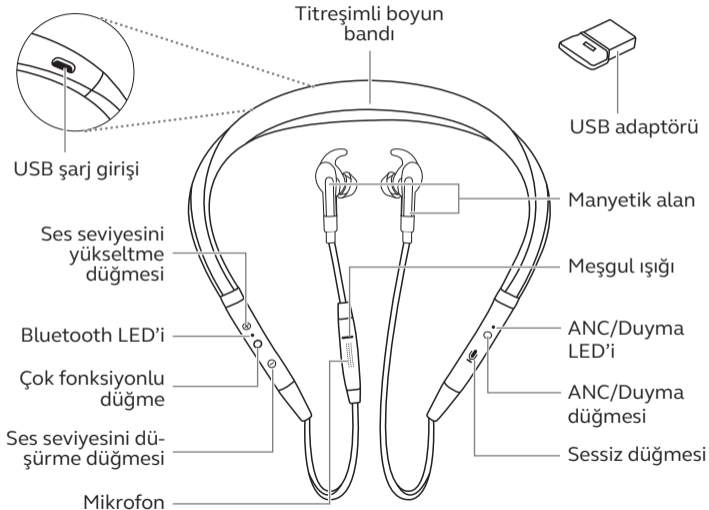

Aktif Gürültü Önleme

İstenmeyen arka plan gürültülerini yok etmek için ANC düğmesine basın.



Duyma fonksiyonu

Kulaklığınızı çıkarmadan çevrenizi duymak için Duyma düğmesine 2 saniye boyunca basılı tutun.



ŞARJ ETME

Kulaklığı PC'nizde veya duvar şarj cihazınızdaki bir USB girişine bağlayın.

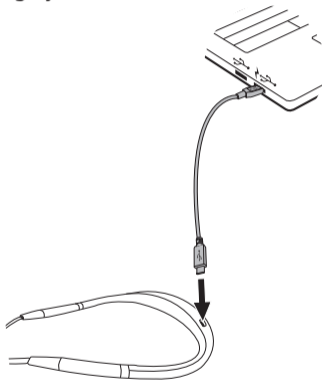

Kulaklığın tamamen şarj olması, yaklaşık 2 saat sürer.

© 2017 GN Audio A/S. All rights reserved. Jabra® is a trademark of GN Audio A/S. The Bluetooth® word mark and logos are registered trademarks owned by the Bluetooth SIG, Inc. and any use of such marks by GN Audio A/S is under license.

Made in China
MODEL: HSC070W/END040W
CMIIT ID: 2017DJ1027
CMIIT ID: 2017DJ6617

FCC ID: BCE-HSC070W/BCE-END040W
IC: 2386C-HSC070W/2386C-END040W
GB 15629.1102-2003 Complies



006-000512
006-000458



CCA17LP0460T0
CCA17LP3960T6



Declaration of Conformity can be found on
www.jabra.com/CP/US/declarations-of-conformity