







Überlastrelais
Overload Relay
Relais de surcharge
Relé na přetížení
Montaža odvodnika prenapona
Bimetalni relej
Przełącznik termiczny



EN 60947, IEC 60947





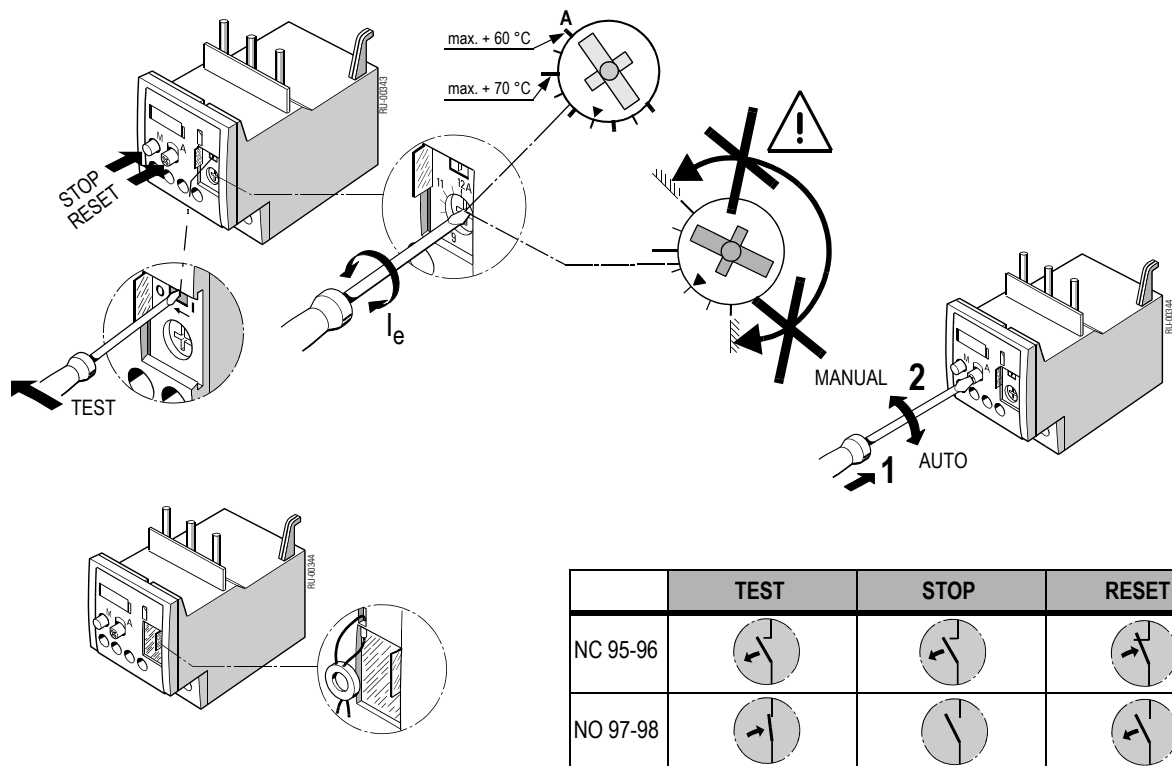
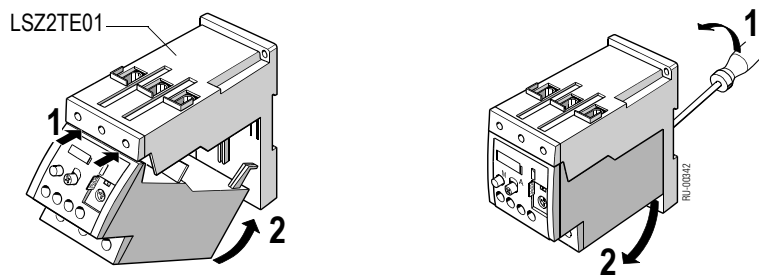
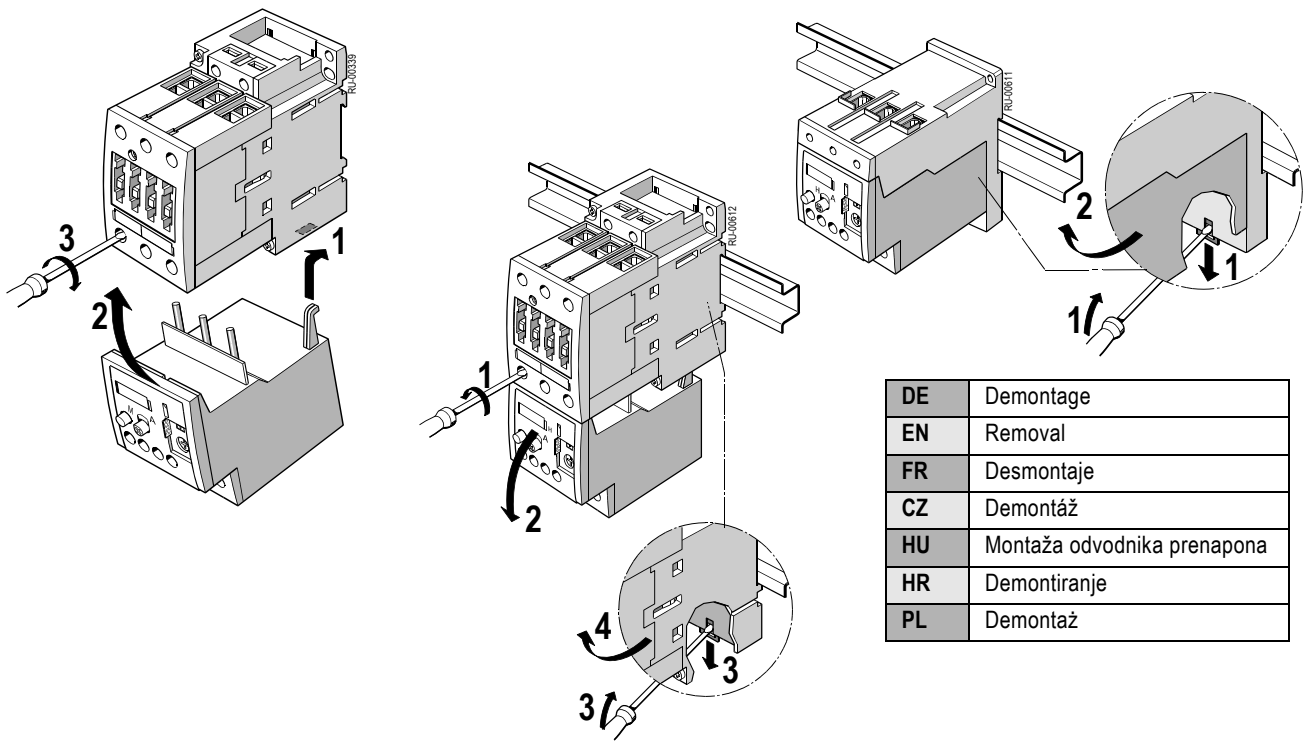

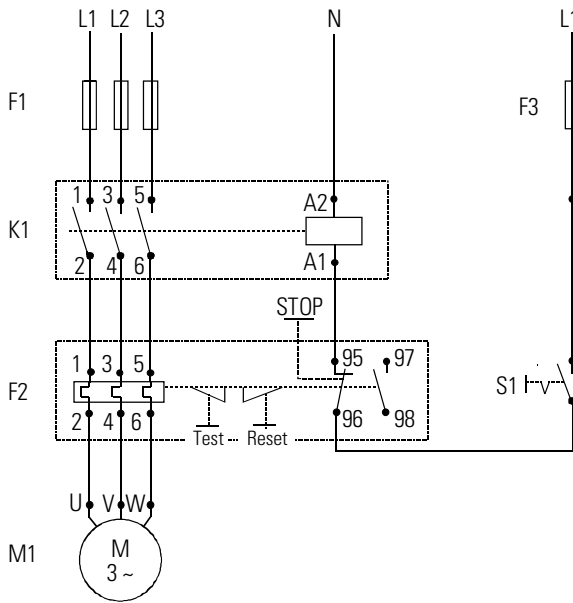
	Betriebsanleitung Kezelési útmutató	Operating Instructions Uputstvo za uporabu	Instructions de service Instrukcje obsługi	Návod k obsluze
Deutsch	⚠ GEFÄHR		VORSICHT	
	Vor der Installation, dem Betrieb oder der Wartung des Geräts muss diese Anleitung gelesen und verstanden werden.		Gefährliche Spannung. Lebensgefahr oder schwere Verletzungsgefahr. Vor Beginn der Arbeiten Anlage und Gerät spannungsfrei schalten.	Eine sichere Gerätefunktion ist nur mit zertifizierten Komponenten gewährleistet.
English	⚠ DANGER		CAUTION	
	Read and understand these instructions before installing, operating, or maintaining the equipment.		Hazardous voltage. Will cause death or serious injury. Turn off and lock out all power supplying this device before working on this device.	Reliable functioning of the equipment is only ensured with certified components.
Français	⚠ DANGER		PRUDENCE	
	Ne pas installer, utiliser ou intervenir sur cet équipement avant d'avoir lu et assimilé les présentes instructions et notamment les conseils de sécurité et mises en garde qui y figurent.		Tension dangereuse. Danger de mort ou risque de blessures graves. Mettre hors tension avant d'intervenir sur l'appareil.	La sécurité de fonctionnement de l'appareil n'est garantie qu'avec des composants certifiés.
Česky	⚠ NEBEZPEČÍ		POZOR	
	Před instalací, uvedením do provozu nebo údržbou si pozorně přečtete tento návod.		Nebezpečné napětí. Nebezpečí smrti nebo těžkého poranění. Před započetím prací odpojte od napájecího napětí.	Spolehlivá funkce zařízení je zaručena pouze s certifikovanými komponenty.
Magyar	⚠ VESZÉLY		VIGYÁZZ	
	A készüléken történő bármilyen munkavégzés megkezdése előtt kérjük, figyelmesen tanulmányozza a kezelési útmutatót!		Veszélyes feszültség! Életveszély! A készüléken történő munkavégzés előtt feszültségmentesítse azt!	A készülék megbízható működése csak minősített alkatrészekkel biztosított.
Hrvatski	⚠ UPOZORENJE		OPREZ	
	Prije stavljanja u pogon, rada ili održavanja pažljivo pročitati ova uputstva.		Visoki napon. Može uzrokovati smrt ili ozbiljne ozlijede. Isključite i odspojite sva napajanja ovog uređaja prije bilo kakvog rada na njemu.	Amo primjena originalnih i certificiranih dijelova osigurava pouzdan rad uređaja.
Polski	⚠ NIEBEZPIECZEŃSTWO		UWAGA	
	Instalacja, obsługa, montaż powinny być poprzedzone uważnym przeczytaniem tych instrukcji.		Niebezpieczne napięcie. Istnieje zagrożenie życia lub zdrowia. Przed dokonaniem jakichkolwiek czynności na tym urządzeniu, wyłącz i zablokuj wszystkie urządzenia zasilające ten aparat.	Tylko stosowanie certyfikowanych komponentów zapewnia właściwe funkcjonowanie tego osprzętu.

Zentrale / Headquarters: SCHRACK TECHNIK GMBH, Seybelgasse 13, A-1230 Vienna
 PHONE: +43(0)1/866 85-0
 FAX: +43(0)1/866 85-1520
 E-mail: export@schrack.com
 Internet: www.schrack.com



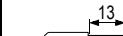

LST2...

	A1/A2; NO/NC		L1 L2 L3 T1 T2 T3
	0,8 ... 1,2 Nm 7 to 10.3 lb·in		3 ... 4,5 Nm 27 to 40 lb·in
	2 x 0,5 ... 1,5 mm ² 2 x 0,75 ... 2,5 mm ²		2 x 0,75 ... 16 mm ²
	2 x 0,5 ... 2,5 mm ²		2 x 0,75 ... 16 mm ² 1 x 0,75 ... 25 mm ²
—	—		2 x 0,75 ... 25 mm ² 1 x 0,75 ... 35 mm ²
AWG	2 x 18 to 14	AWG	2 x 18 to 3 1 x 18 to 2

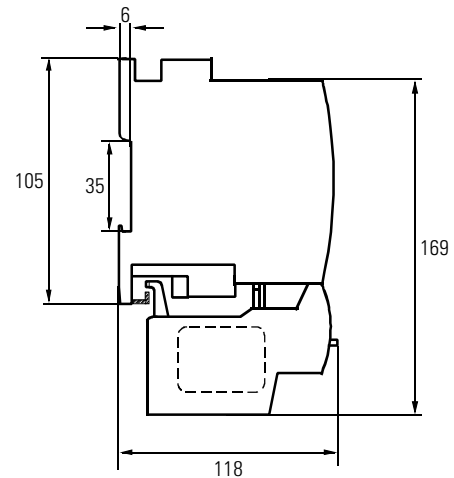
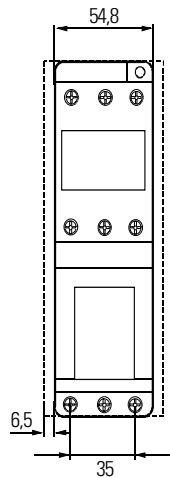
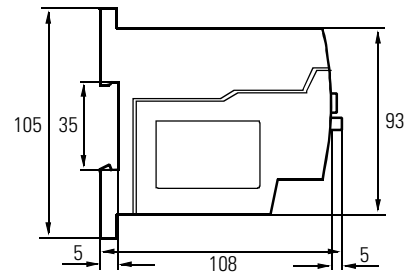
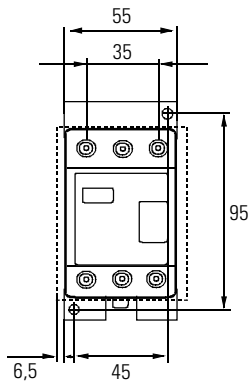
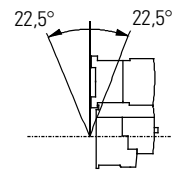
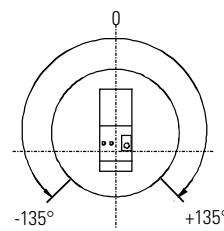
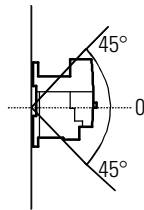
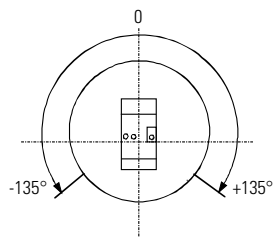

652 0353-10 DS 02