

1

2

3

4

-VX Pin

-VXR Pin

A

A

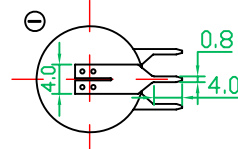
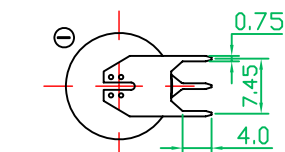

B

B

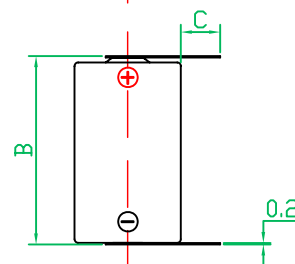
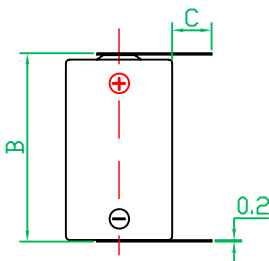

C

C

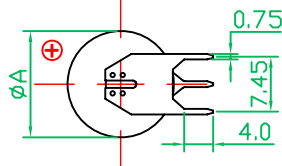
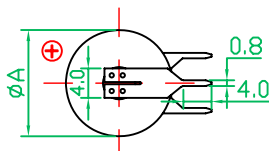

-VB Pin

-VBR Pin

D

D

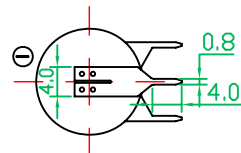
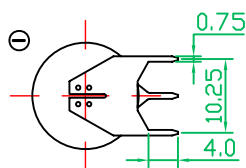

E

E

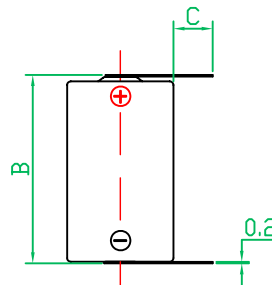
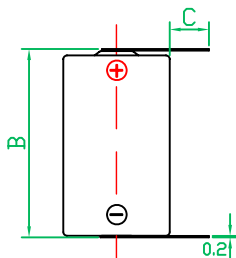

F

F

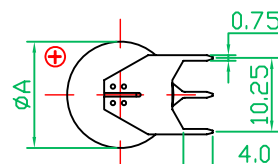
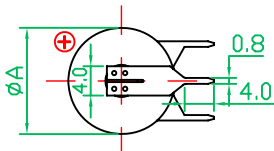

1

2

3

4

1

2

3

4

-VY Pin

-FT Pin

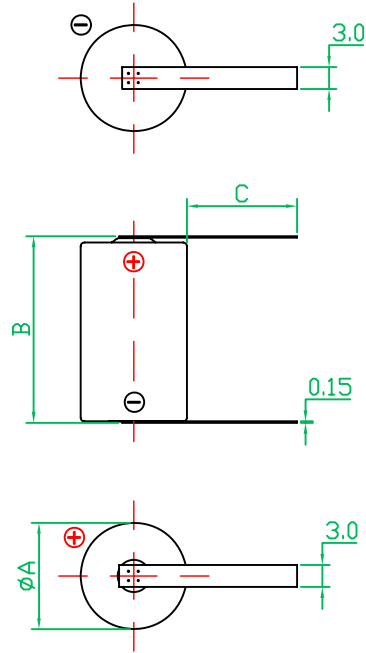
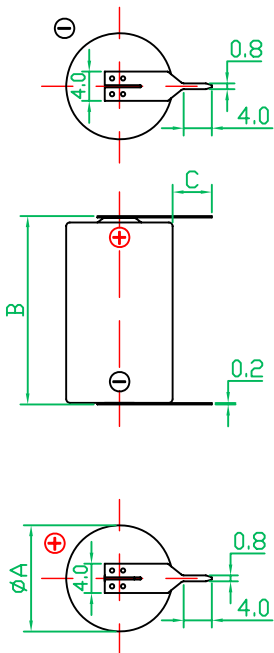

-AV(Axial Pin)

-AX(Axial Pin)

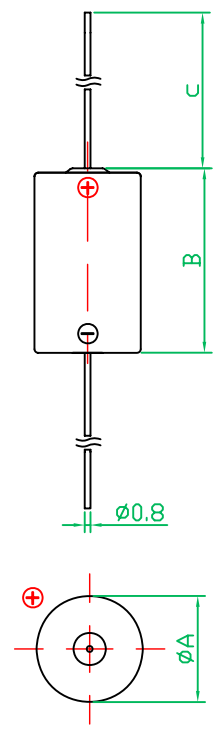
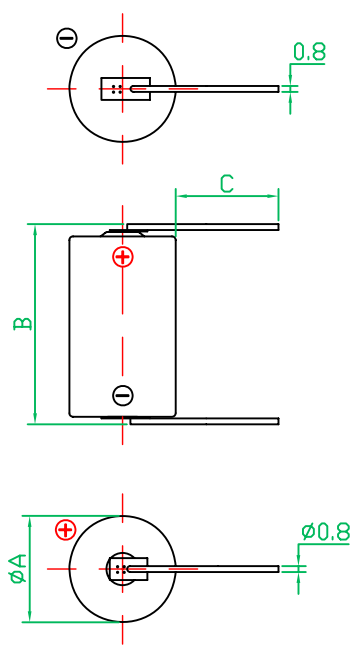

1

2

3

4

A

A

B

B

C

C

D

D

E

E

F

F

1

2

3

4

- LD(Cable)

- LD/(With connector)

A

A

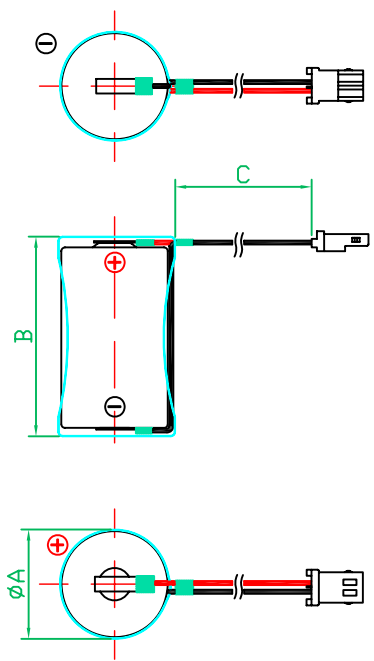
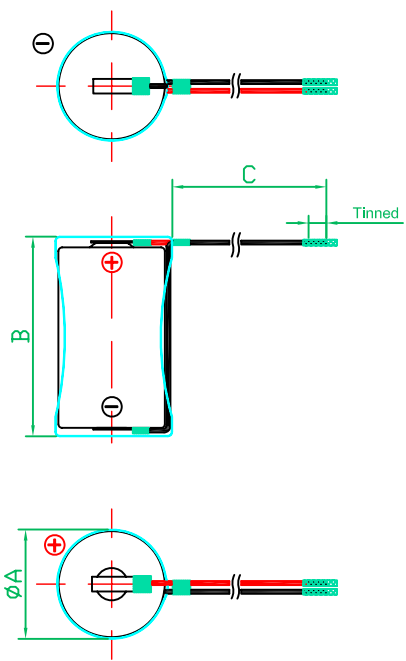

1

2

3

4

C

C

B

B