



D SERIES MODULAR AIR-COOLED SCROLL CHILLERS SERVICE MANUAL

**T1/R410A/50Hz
(GC201307-I)**

GREE ELECTRIC APPLIANCES, INC. OF ZHUHAI

CONTENTS

PRODUCT	2
1 LINEUP	2
2 NOMENCLATURE	2
3 FEATURES	3
4 PRODUCT DATA	4
5 OPERATION PRINCIPLE	6
CONTROL.....	8
1 OPERATION FLOWCHART	8
2 CONTROL LOGIC	10
3 CONTROLLER	12
INSTALLATION.....	17
1 BEFORE INSTALLATION	17
2 INSTALLATION LOCATION.....	17
3 CAUTION FOR INSTALLATION	17
4 DIMENSION DATA.....	17
5 MACHINE FOOTPRINT.....	19
6 TYPICAL WATER PIPING DIAGRAM	20
7 FREEZE PROTECTION	21
8 ELECTRIC WIRING WORK.....	21
MAINTENANCE.....	28
1 ERROR LIST	28
2 FLOW CHART OF TROUBLESHOOTING	29
3 REMOVALS AND REINSTALLATION.....	34
4 ROUTINE MAINTENANCE.....	48
5 EXPLODED VIEWS AND PART LIST.....	50

PRODUCT



PRODUCT

1 LINEUP

Series	Model Name	Product Code	Capacity (kW/Ton)		Power Supply	Refrigerant	Appearance
			Cooling	Heating			
D	LSQWRF65M/NaD-M	EL01500500	60/17.06	65/18.48	380-415V,3Ph,50Hz	R410A	
	LSQWRF80M/NaD-M	EL01500520	71/20.19	79.5/22.61			
	LSQWRF130M/NaD-M	EL01500510	120/34.12	130/36.97			
	LSQWRF160M/NaD-M	EL01500530	145/41.23	170/48.34			

Note: 1Ton = 12000Btu/h = 3.517kW

2 NOMENCLATURE

LS	QW	R	F	130	M	/	Na	D	-	M
1	2	3	4	5	6		7	8		9

NO.	Items	Options
1	Product type	LS- chillers
2	Compressor type	QW- hermetic scroll compressors
3	Function type	Default-cooling only R-heat pump
4	Condenser type	F: air-cooled
5	Nominal cooling capacity	65:60kW= 17.06 RT 80:71kW=20.19 RT 130:120kW=34.12 RT 160:145kW=41.23 RT
6	Structural design	M-modular design
7	Refrigerant	Default-R22 Na-R410A
8	Development number	—
9	Power supply	M – 380-415V,3Ph,50Hz

3 FEATURES

3.1 General

D series modular air-cooled scroll chillers are well-developed products incorporated with multiple advanced technologies. It features the low noise level, compact structure, easy operation, reliable running, and convenient installation and service, widely used at newly built or retrofitted industrial and civil buildings in various sizes, such as, hotels, apartments, restaurants, office buildings, shopping malls, theaters, gyms, workshops, hospitals and other places where there are high requirements on noise level and air quality but it is troublesome to install the cooling tower.

D series modular air-cooled scroll chillers are constructed of one or up to 16 single units which may vary in structure and in cooling capacity. The 65, 80 units have two independent refrigeration cycle and the 130,160 units have four. The modular design is able to realize the modular system with the cooling capacity ranging from 60 to 1160kW.

3.2 Features

D series modular air-cooled scroll chillers work outstandingly by virtue of their major features stated below.

- ◆ **High energy efficiency:** It is initially certified as one of the energy-saving chiller products in China.
- ◆ **Free master unit design:** Any single unit can operate as the master once connected with the control panel. It overcomes the problem which would occur to the product of other manufacturer that the whole system would fail to work properly when the fixed master unit malfunctions.
- ◆ **Excellent compatibility:** Each chiller is constructed of up to 16 single units of 65NaD,80NaD or up to 8 single units of 130NaD,160NaD.
- ◆ **Hermetic scroll compressor:** Compared with other type of compressor under the same cooling load, it has few movable components, smaller rotating torque, lower noise and vibration and higher reliability and efficiency.
- ◆ **Super protection:** It is equipped with the top-end microcomputer control system which is capable of providing well-rounded protection and self-diagnosis, such as high/low pressure protection, freeze protection, over-temperature protection, compressor overload protection, phase loss/reversal protection, water flow switch protection, etc.
- ◆ **High reliability:** It is constructed of well-designed refrigeration parts for multiple refrigeration cycles, adequately guaranteeing the reliable operation.
- ◆ **Compact structure:** The modular design enables the compact structure, reduced volume, light weight, easy handling and shipping and flexible installation.
- ◆ **Low maintenance cost:** The especially design structure allows easy access and service and low maintenance cost.
- ◆ **Low noise:** The unit runs with low noise and vibration, widely applicable for various projects.
- ◆ **Quiet mode:** The unit is allowed to run in the quiet mode based on the user's requirement, which can not only save energy but also create a comfortable and pleasant living environment.
- ◆ **Economy mode:** The unit can run in the economy mode without lessening the air conditioning effect so as to cut down the electricity consumption.
- ◆ **Equilibrium running:** It indicates each compressor will run alternately so as to extend their service life.
- ◆ **Powerful remote monitoring:** Gree centralized air conditioning system can be perfectly integrated to the BMS or Gree remote monitoring system so as to realize remote control to its operation and remote monitoring to its running parameters and alarm data etc.

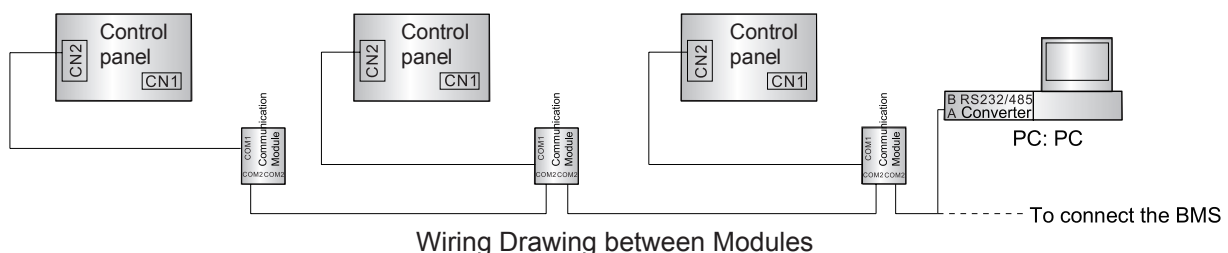

- ◆ **Intelligent ON/OFF control:** The unit is capable of automatically turning on/off the compressor through controlling the entering water temperature and the temperature rise rate in accordance with the change in load so as to make the capacity of the unit perfectly match the required load and reduce to the most extent the electricity consumption and effectively avoid remarkable temperature fluctuation.



4 PRODUCT DATA

4.1 Product Data at Rated Condition

Models		Heat Pump	LSQWRF65M/NaD-M	LSQWRF80M/NaD-M	LSQWRF130M/NaD-M	LSQWRF160M/NaD-M
		Product Code	EL01500500	EL01500520	EL01500510	EL01500530
Capacity steps		%	0-50-100	0-50-100	0-25-50-75-100	0-25-50-75-100
Capacity	Cooling	kW	60	71	120	145
		Ton	17.06	20.19	34.12	41.23
	Heating	kW	65	79.5	130	170
		Ton	18.48	22.61	36.97	48.34
Power Input	Cooling	kW	21.1	25.7	42.3	53.0
	Heating	kW	21.0	27.0	44.4	56.0
EER		W/W	2.84	2.76	2.84	2.74
COP		W/W	3.09	2.94	2.93	3.04
Power Supply		—	380-415V,3Ph,50Hz			
Running Control		—	Microcomputer Auto Control; Running Status Display; Abnormal Status Alarm			
Safeties		—	High-low pressure protection, discharge temp. protection, motor overload protection, anti-freeze, water flow protection, phase-sequence protection, compressor overload protection			
Compressor	Type	—	Constant Speed Scroll			
	Starting mode	—	Direct starting			
	Quantity	—	2	2	4	4
Refrigerant Type		—	R410A			
Water side heat exchanger	Type	—	Dry Expansion Evaporator			
	Water flow volume	m ³ /h	10.3	12.2	20.6	24.9
		GPM	45.0	54.0	91.0	110.0
	Pressure Drop	kPa	15	20	30	35
		ft.WG	4.92	6.56	9.84	11.48
Max. working Pressure	MPa	1				
water in/outlet pipe flange specification	mm	DN65	DN65	DN80	DN80	
Air side heat exchanger	Type	—	Aluminum Fin-copper Tube			
	Fan type/ Number of fans	—	Axial Fan/2	Axial Fan/2	Axial Fan/4	Axial Fan/4
	Total fan air flow	m ³ /h	2.7×10 ⁴	3.0×10 ⁴	5.4×10 ⁴	6.0×10 ⁴
		L/s	0.75×10 ⁴	0.83×10 ⁴	1.5×10 ⁴	1.67×10 ⁴
		CFM	1.59×10 ⁴	1.764×10 ⁴	3.18×10 ⁴	3.528×10 ⁴
Total fan motor power	kW	0.65×2	0.95×2	0.65×4	0.95×2	
Sound pressure level		dB(A)	70	71	72	74
Outline Dimension	Width	mm	2040	2040	2226	2226
	Depth	mm	1000	1000	1650	1650
	Height	mm	2230	2230	2230	2230
Net Weights		kg	710	760	1256	1440
Operating weight		kg	781	836	1382	1584
Auxiliary electric heater-power (Ref.)		kW	15	15	30	30
Loading quantity	40'GP/40'HQ	—	10/10	10/10	6/6	6/6

Notes:

- a. The unit is designed, manufactured, inspected and tested in accordance with GB/T18430.1-2007.
- b. Parameters on the nameplate always take precedence.
- c. Consult the local sales agency concerning special requirements and we will go to the length of figuring out the most feasible solution.

4.2 Nominal capacities are based on the follow conditions:

Item	Water side		Air side	
	Water flow volume	Leaving Water Temperature	Dry-bull temp.	Wet-bull temp.
	m ³ /(h·kw)	(°C / °F)	(°C / °F)	(°C / °F)
Cooling	0.172	7/45	35/95	—
Heating		45/113	7/45	6/43

4.3 Operation Range

	Water side		Air side
	Leaving Water Temperature	Temperature Difference of Water	Air on Condenser
	(°C / °F)	(°C / °F)	(°C / °F)
Cooling	5~15/41~59	2.5~6/37~43	15~45/59~113
Heating	40~50/104~122	2.5~6/37~43	-15~24/5~75

Note: when the unit is going to operate beyond the working conditions, please contact Gree for consultation.

4.4 Electric Data

Model	Rated Power Supply	Compressor			Fan Motor		Air Switch
		Qty	MRC Each (A)	NRC Each (A)	Qty.	NRC Each (A)	MRC (A)
LSQWRF65M/NaD-M	380-415V, 3Ph, 50Hz	2	29.1	17.6	2	1.71	63
LSQWRF80M/NaD-M		2	29.3	25.7	2	2.50	80
LSQWRF130M/NaD-M		4	29.1	17.6	4	1.71	125
LSQWRF160M/NaD-M		4	35	25.7	4	2.50	160

Notes:

MRC: Maximum running current (A).

NRC: Nominal running current (A).



5 OPERATION PRINCIPLE

5.1 Schematic Diagram

Each circuit of the modular chiller is independent and identical and herein only a circuit is taken for an example.

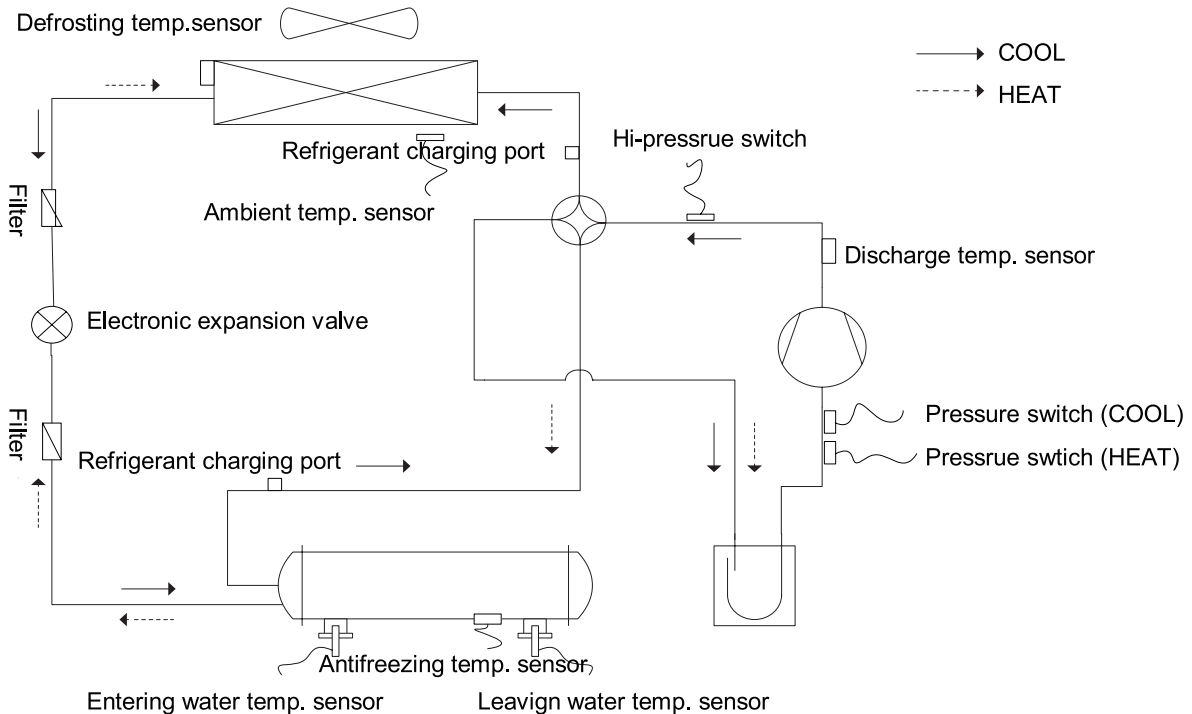

- ◆ **Refrigeration Cycle:** The low-pressure superheated refrigerant vapor from the evaporator is drawn into the compressor through which the low-pressure vapor is compressed to hi-temperature and hi-pressure refrigerant vapor. Then, the refrigerant vapor passes the condenser and turns to saturated or sub-cooled refrigerant liquid. And then, it passes the throttling device and flows into the evaporator where it evaporates by absorbing heat from the second refrigerant and then is drawn into the compressor again. The second refrigerant is then transferred to where air cooling is required.
- ◆ **Reverse Refrigeration Cycle:** During the reverse refrigeration cycle, a 4-way valve is used to make the refrigerant flow in a reverse direction as stated below. The hi-temperature and hi-pressure refrigerant vapor coming out from the compressor directly releases heat to the secondary refrigerant and turns to the refrigeration liquid. Then, the refrigerant vapor passes the throttling device and flows into the air-cooled exchanger where it evaporates by absorbing heat from the surrounding environment and then is drawn into the compressor again. The second refrigerant which has approached the temperature set point is then transferred to where air heating is required.

CONTROL



CONTROL

1 OPERATION FLOWCHART

1.1 Cooling Operation

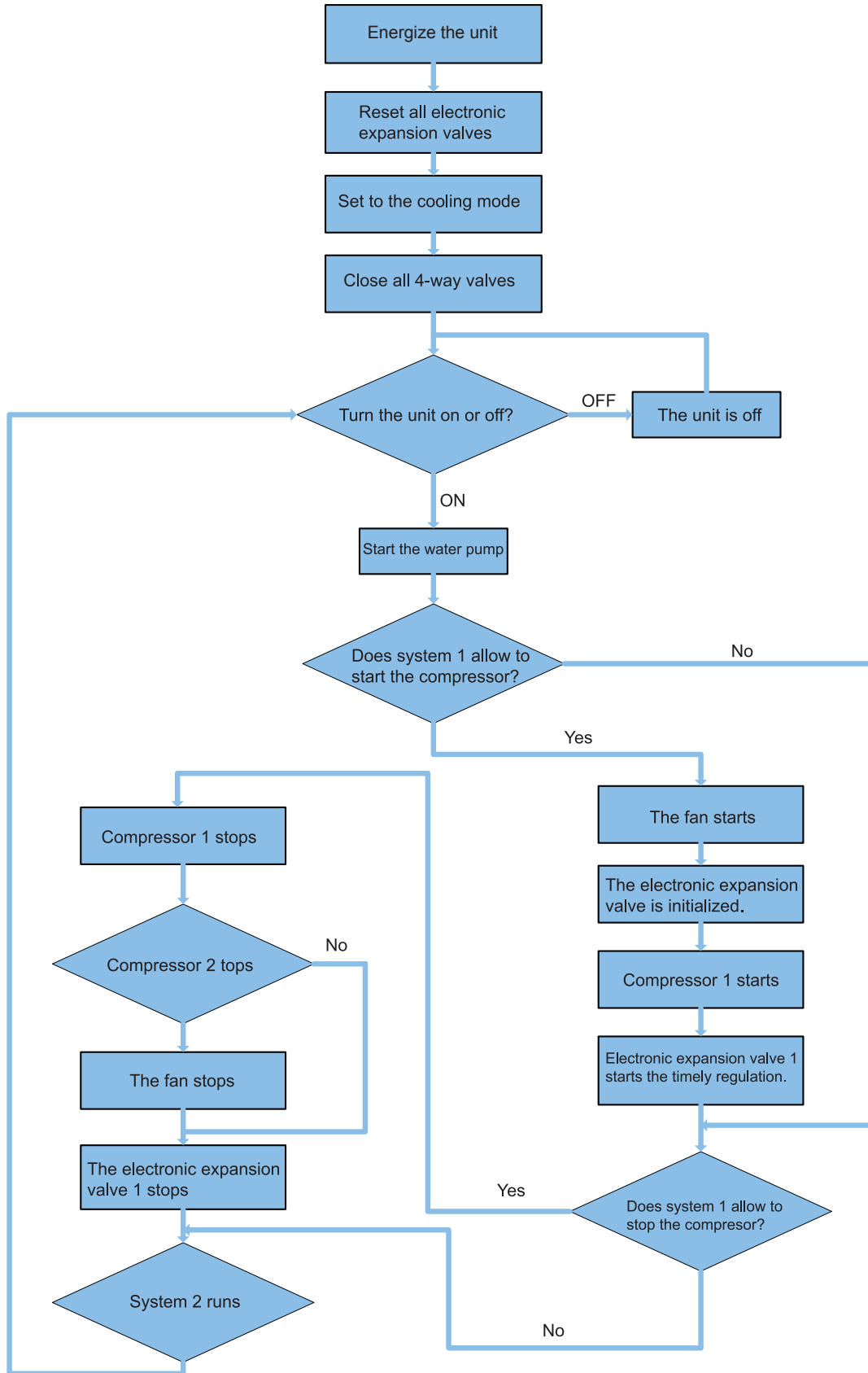

1.2 Heating Operation

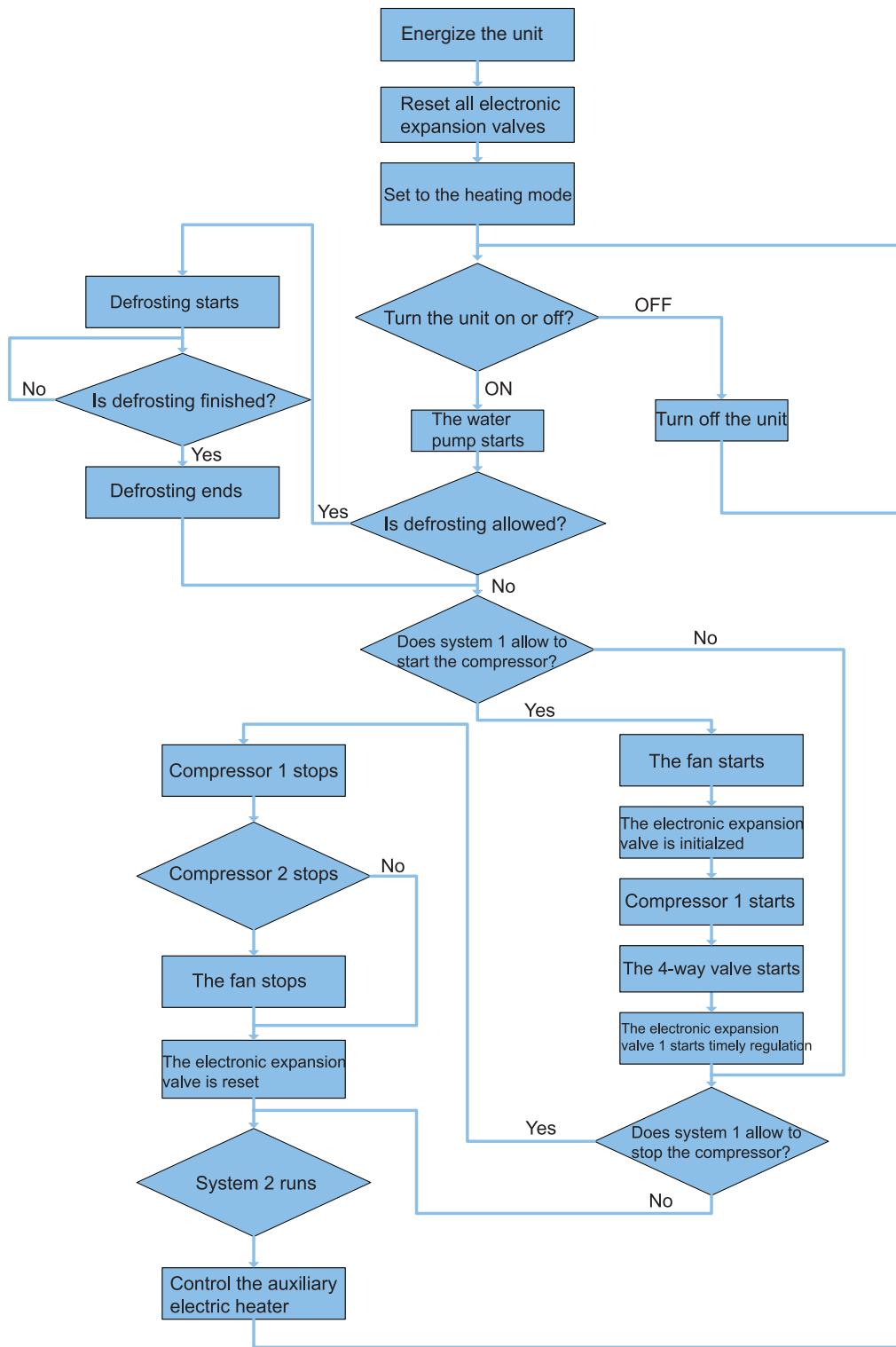



2 CONTROL LOGIC

2.1 Cooling Control

2.1.1 Control to the Compressor

(1). “First On, First Off”

“First On, First Off”/“First Off, First On” control indicates the numbered compressor which is started/stopped firstly will then be stopped/started firstly.

(2). Temperature Drop/Rise Rate Control

The water temperature range control assisted by the temperature drop/rise rate control is capable of precisely adapting the load change of the terminal units and avoiding remarkable water temperature fluctuation.

2.1.2 Freeze Protection

For each single module, when the anti-freezing temperature or the leaving water temperature is lower than the limit value, freeze protection will work and this module stops; when the anti-freezing temperature and the leaving water temperature go higher than the normal value, freeze protection will quit; when the anti-freezing temperature and the leaving water temperature are between the limit value and the normal value, the module is protected again freeze.

2.1.3 Shutdown

Shutdown manually or timely: in this case, the compressor and the auxiliary electric heater stop firstly, then the electronic expansion valve initializes, and then the 4-way valve is de-energized, and lastly the water pump stops.

Shutdown when reaching the set point: in this case, the compressor stops firstly, and then the fan stops and the electronic expansion valve initializes. However, the 4-way valve keeps its state unchanged and the water pump keeps running.

Shutdown due to errors: in this case, the compressor stops firstly, and then the fan stops (except that the fan is malfunctioning), and the electronic expansion valve initializes. However, the 4-way valve keeps its state unchanged and the water pump keeps running.

2.2 Heating Control

2.2.1 Control on the Compressor

It is the same as that in selection 2.1.1.

2.2.2 Over-temperature Protection

For each single module, when the over-temperature is higher than the limit value, over-temperature protection will work; when the over-temperature goes lower than the normal value, over-temperature protection will quit; when the over-temperature is between the limit value and the normal value, the module is still protected again over-temperature.

2.2.3 Control on the Auxiliary Electric Heater

When the auxiliary electric heater is enabled through the wired controller, it will work in accordance with the change of the entering water temperature.

When the flow switch and the entering water temperature sensors work normally, any other error can be ignored.

When the auxiliary electric heater is disabled through the wired controller, the auxiliary electric heater will stop working.

When all entering water temperature sensors malfunction, the auxiliary electric heater will stop working.

When any flow switch malfunctions, the auxiliary electric heater will stop working.

When the unit is under over-temperature protection but the auxiliary electric heater is not allowed to stop, the auxiliary electric heater will keep working until the entering water temperature reaches the set point.

2.2.4 Shutdown

Shutdown manually or timely: in this case, the compressor and the auxiliary electric heater stop firstly, then the electronic expansion valve initializes, and then the 4-way valve is de-energized, and lastly the water pump stops.

Shutdown when reaching the set point: in this case, the compressor stops firstly, and then the fan stops and

the electronic expansion valve initializes. However, the 4-way valve keeps its state unchanged and the water pump keeps running.

Shutdown due to errors: in this case, the compressor stops firstly, and then the fan stops (except that the fan is malfunctioning), and the electronic expansion valve initializes. However, the 4-way valve keeps its state unchanged and the water pump keeps running.

2.3 Freeze Protection

Under the OFF state at any mode (except the manual defrosting mode), when the freeze protection is activated through the wired controller, the unit will be protected against freeze. Freeze protection is factory defaulted to be ON.

When the module is in the freeze protection, its compressor will work as per the on/off setting and also the principle of "Six-minute On, Three-minute Off".

2.4 Control to the Compressor

All compressors run as per the principle of "First On, First Off" and "First Off, First On". See section 2.1 and section 2.2.

2.5 Control to the Fan

The fan starts earlier than the compressor upon startup, and stops later than the compressor upon shutdown. During defrosting, the fan and the 4-way valve stop. After defrosting they start again.

2.6 Control to the 4-way Valve

The 4-way valve is stopped at the cooling mode. At the heating mode, it will start after the compressor runs. During defrosting it stops and then starts again after defrosting. It will stop later than the compressor upon shutdown.

2.7 Control to the Water Pump

When any module is required to run (incl. manual startup, timely startup, startup again freeze), water pumps of all modules start. Then, when one module reaches the set point and is shut down, water pumps of all modules keep running; when one module is shut down manually or timely, its water pump keeps running and will stop only after all modules are shut down; when one module malfunctions and is shutdown, its water pump keeps running.

2.8 Control to the Electronic Expansion Valve

The electronic expansion valve initializes when the wired controller is emerged for the first time. After the compressor has been started, the electronic expansion valve starts to adjust its opening angle.

2.9 Protection

2.9.1 Recoverable Protection

◆ Compressor 1/2 low pressure protection

When it is detected the low-pressure switch of compressor 1 (compressor 2) is opened compressor 1 (compressor 2) will be shut down immediately.

Meanwhile the indicating LED will light on and the error information will be displayed among the error log which must be manually cleared for normal operation of next time.

◆ Compressor 1/2 high discharge protection

When it is detected in three consecutive seconds that the discharge temperature of compressor 1 (compressor 2) exceeds the set point, compressor 1 (compressor 2) will be shut down immediately but the fan will still run for some time.

Meanwhile the indicating LED will light on and the error information will be displayed among the error log which must be manually cleared for normal operation of next time.

2.9.2 Irrecoverable Protection

◆ Compressor 1/2 high pressure or over-current protection

When it is detected that the high pressure switch of compressor 1 (or compressor 2) is open, compressor 1 (or compressor 2) will be shut down but the fan will still last for some time.

Meanwhile the indicating LED will light on and the error information will be displayed among the error log which must be manually cleared for normal operation of next time.



◆ Fan 1/2 over-current protection

When any fan is over-current, this module unit will be shut down automatically. Meanwhile, the error information will be displayed among the error log which must be manually cleared for normal operation of next time.

◆ Flow switch protection

When a single module unit detect that the flow switch is closed (under normal condition, it keeps open), it will be shut down automatically.

When all modules are shut down because of flow switch protection, the water pump will stop.

◆ Communication protection

When a single module unit fails to receive any signal from the wired controller, it will be shut down automatically and then the water pump will stop.

◆ Phase loss/reversal protection

When phase loss/reversal occurs, the power supply to the main board will be cut off.

3 CONTROLLER

3.1 Wired Controller

This wired controller, especially designed for D series modular air-cooled chillers, is capable of controlling and displaying each running parameter of the chiller and being integrated into the remote monitoring system.

3.1.1 Press Buttons and Icons on the Homepage

(1). Press Buttons

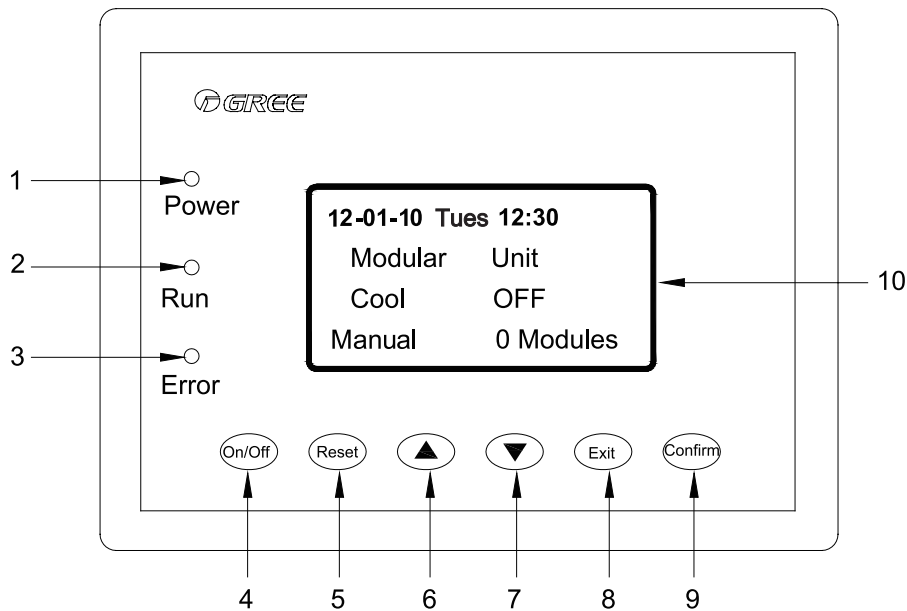

NO.	Name	Function description
1	Power indicator(red)	the indicator is on when the Wired Controller is powered on, or otherwise it is off.
2	Run indicator(green)	the indicator is on when the Wired Controller is started, or otherwise it is off.
3	Error indicator(red)	The indicator is on when the unit is at fault, or otherwise it is off.
4	On/Off button	For controlling unit conversion between start and stop, press the button (for 3 seconds) in stop state to start the unit and press the button (for 3 seconds) in operation state to stop the unit.
5	Reset button	Press the button to clear fault and relieve the air discharge temperature sensor locking.
6	Up selection button	in menu selection, press the button to move the cursor upward or leftward; and in data modification mode, press the button to increase the value.
7	Down selection button	In menu selection, press the button to move the cursor downward or rightward; and in data modification mode, press the button to decrease the value.
8	Exit button	Press the button to go back to the previous menu.
9	Confirm button	In menu selection, press the button to confirm the selected item; and in data modification mode, press the button to confirm the parameter and move the cursor.
10	LCD	Information display zone.

(2). Display Icons on the Homepage

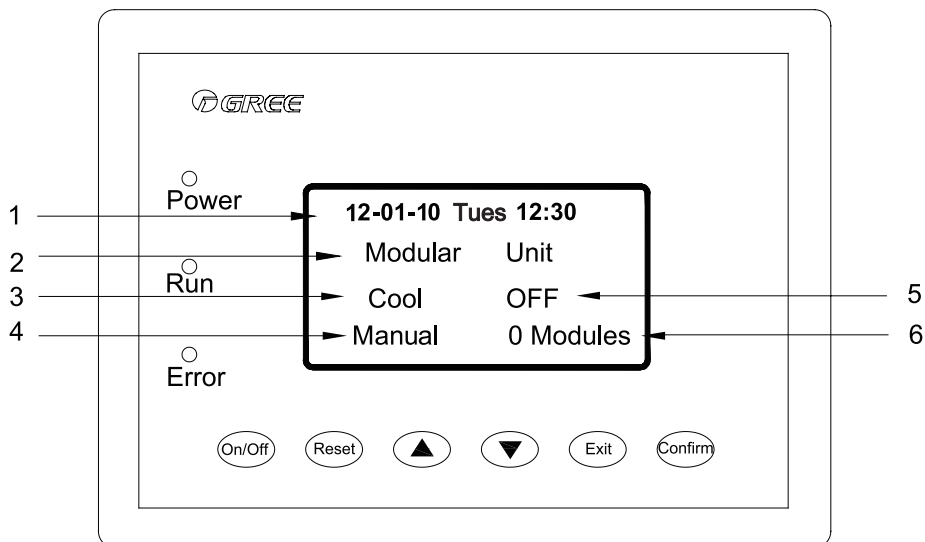

No.	Icon	Description
1	Time	It indicates the current time.
2	Unit name	It indicates the unit name.
3	Running mode	It indicates the running mode (cooling, heating or manual defrosting)
4	On/Off mode	It indicate the on/off mode, manual or timing)
5	Running status	It indicates the running status, on or off.
6	Module quantity	It indicates how many modules this system is consisted of. (max. 16)



3.1.2 Menu Structure of Controller

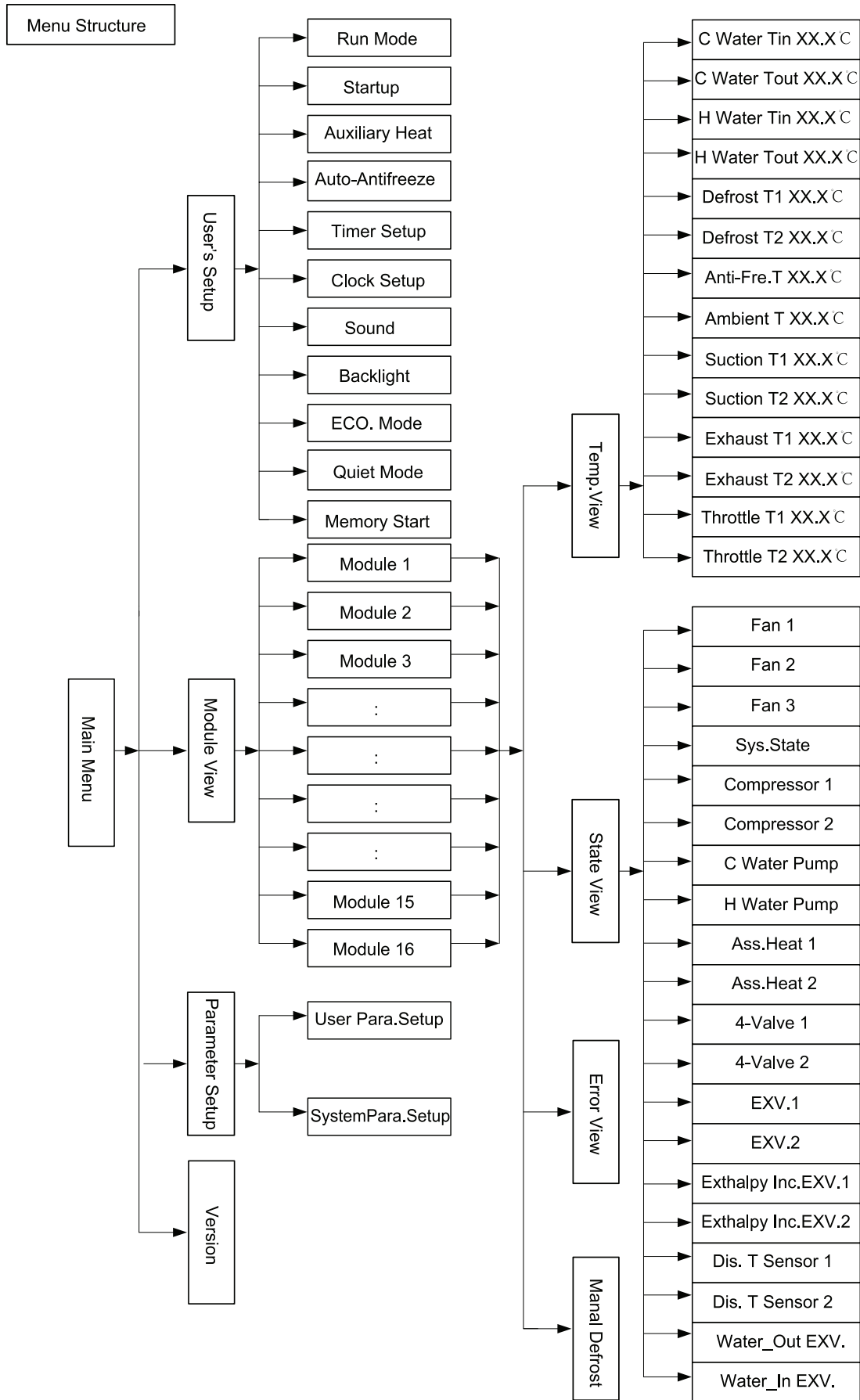

3.2 Setup of Toggle Switches on the Motherboard

Four bit toggle switches are used for indicating hardware address (1~16) of modules, with module No. displayed in turn on the panel as Module 1, Module 2,, Module 16. Toggle switches 1, 2, 3 and 4 are binary code, with 1 for the lowest bit and 4 for the highest bit. Comparison drawings are as follows (Caution: The DIP switch is allowed to be set only when the power supply is cut off and each setting shall be unique.):

Module1



Module2

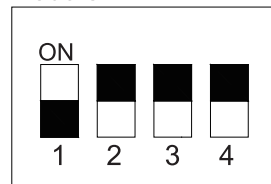

Module3

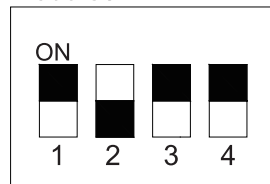

Module4

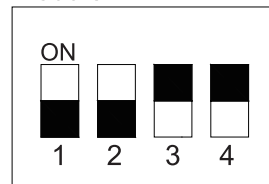

Module5

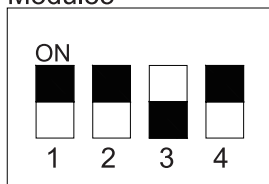

Module6

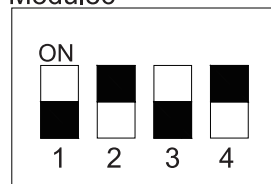

Module7

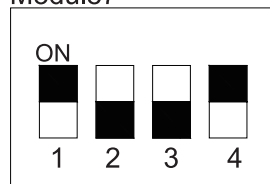

Module8

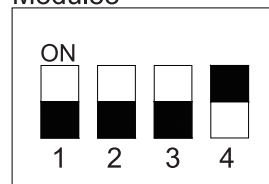

Module9

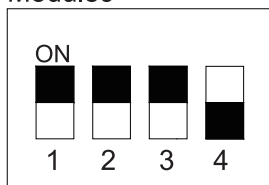

Module10

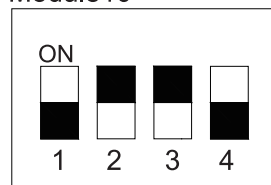

Module11

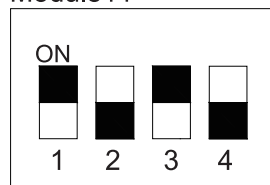

Module12

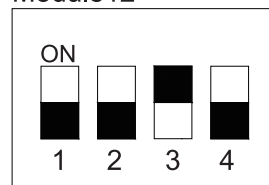

Module13

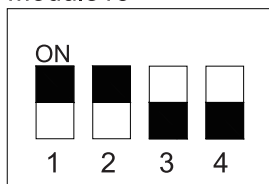

Module14

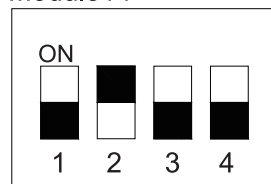

Module15

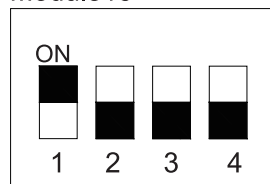

Module16

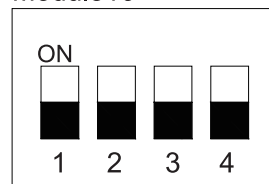



INSTALLATION

INSTALLATION

1 BEFORE INSTALLATION

- ◆ Please check the attached documents for the unit and accessories in accordance with the packing list.
- ◆ Check the model and specification in accordance with attached documents.
- ◆ Check the unit and accessories for damage
- ◆ Check the refrigerant charge for leakage
- ◆ Check the cleanliness of the water pipes. Do not remove the protective cap of the flange before connecting water pipes.
- ◆ Check installation and operation for compliance with the required range.

Through the check above, if there is any damage or problem, please contact the local sales office for help. Note that protective measures shall be taken after unpacked product has gone through all check and do not remove the package too early to avoid any unexpected damage to the product.

2 INSTALLATION LOCATION

In order to guarantee the unit operates normally, installation shall be performed by the skilled serviceman with enough knowledge of refrigeration and air conditioning. Please read this manual carefully before installation.

- ◆ The unit shall be installed outdoor where there is good ventilation and capable of withstand the weight of the unit.
- ◆ Enough space around the unit shall be left for ventilation, operation and service.
- ◆ No obstacle is allowed above the unit.
- ◆ The drainage ditch shall be prepared.

3 CAUTION FOR INSTALLATION

- ◆ Ensure the connection pipe and power line both are routed correctly.
- ◆ Noise and vibration levels shall be among the reliable range, rubber cushion shall be adopted.
- ◆ The base must be constructed of cement or steel, which can bear the operation weight of the machine and has a level surface.
- ◆ The installation location shall be free from fire, flammable matters, corrosive gas or waste gas. Enough ventilation space shall be left and measures should be taken to reduce noise and vibration as much as possible.

4 DIMENSION DATA

(1). Graph for the shape and size for LSQWRF65M/NaD-M, LSQWRF80M/NaD-M

Unit:mm

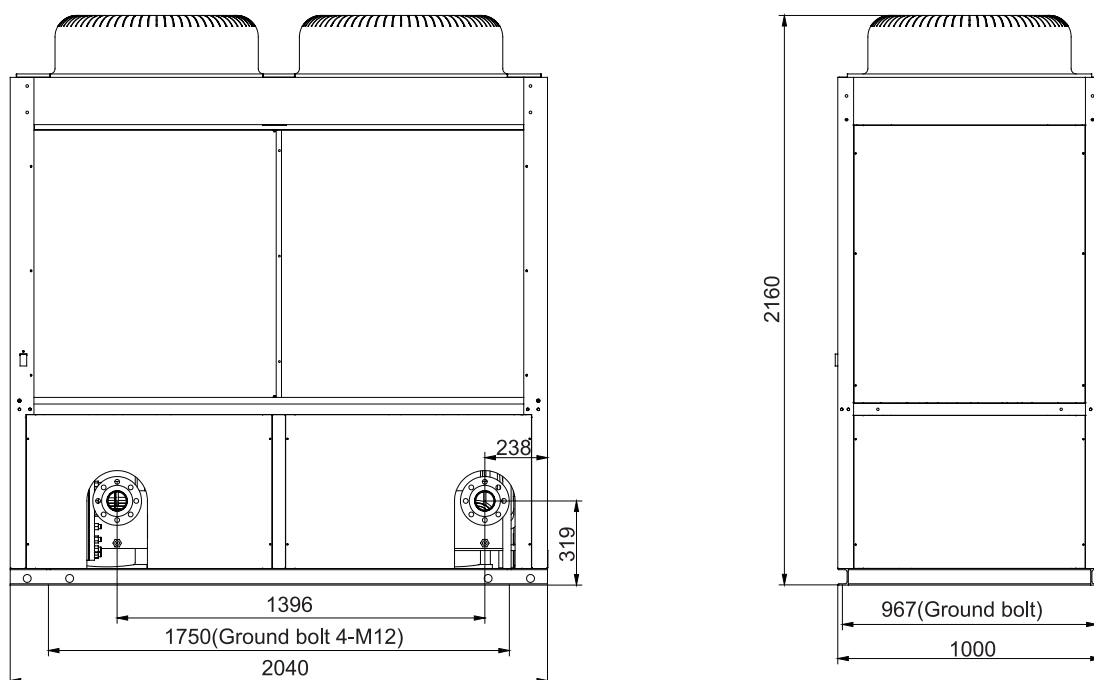



(2). Graph for the shape and size for LSQWRF130M/NaD-M

Unit:mm

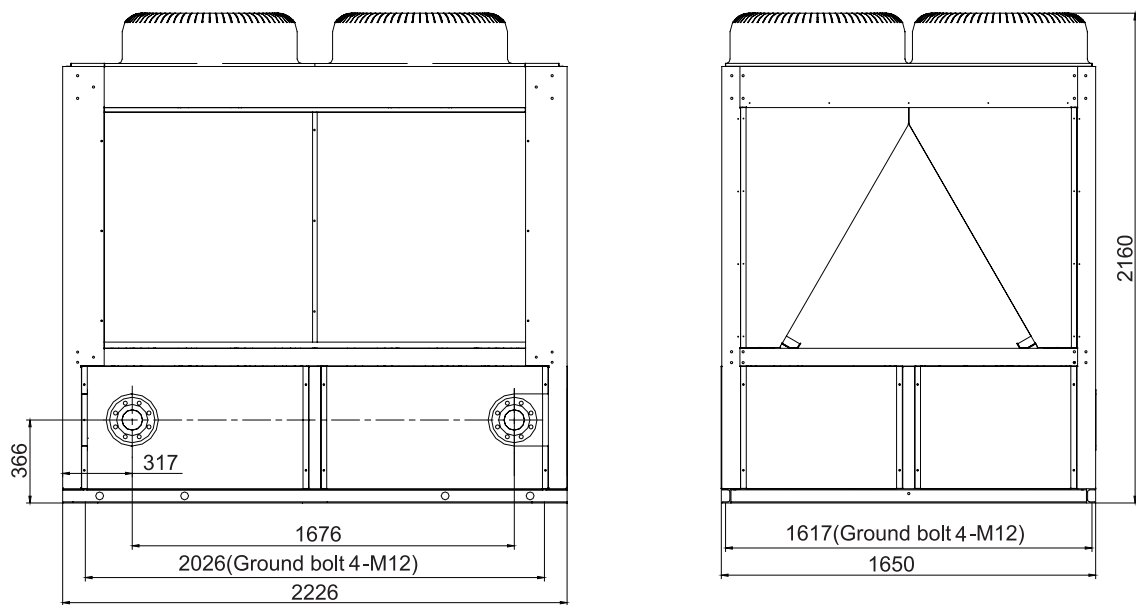

(3). Graph for the shape and size for LSQWRF160M/NaD-M

Unit:mm

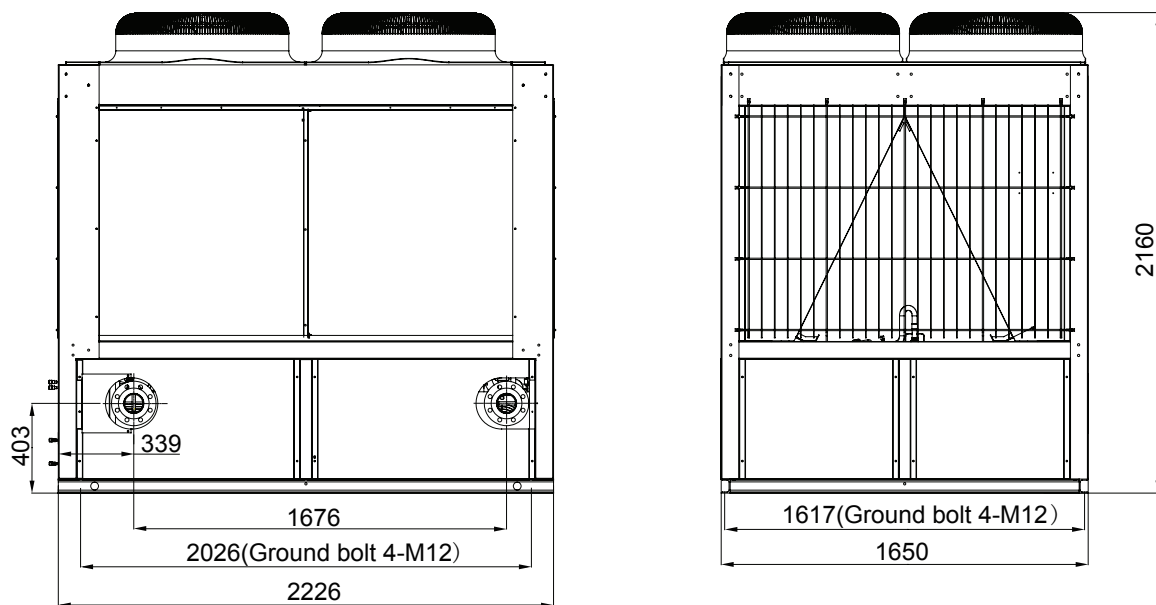

5 MACHINE FOOTPRINT

A minimum spacing of 1m should be left between any two modules for unobstructed air intake and equipment service. Additionally, a minimum of 2m should be kept between the chiller and any barrier. If allowable, it would be better to set up a suncover 3m ahead of the chiller.

Unit:mm

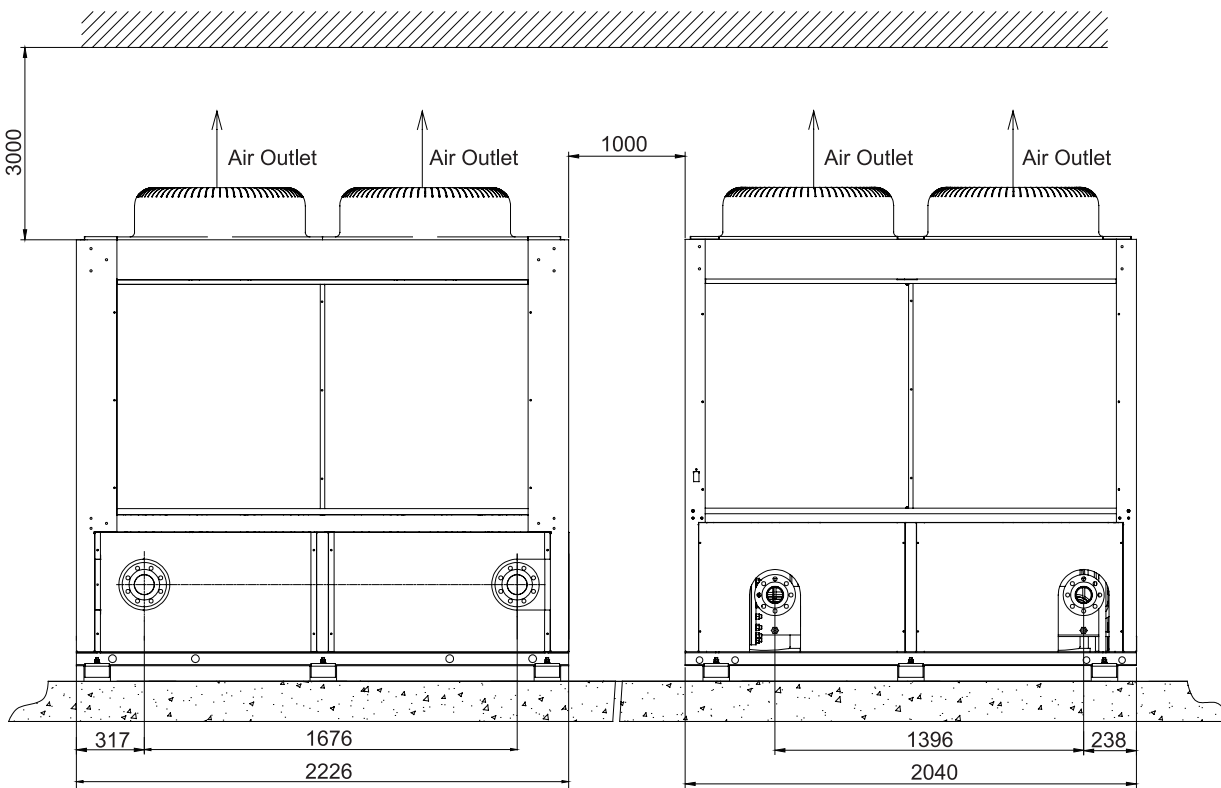

Rubber cushion pad shall be attached under the unit base which shall be fixed on the foundation with bolts.

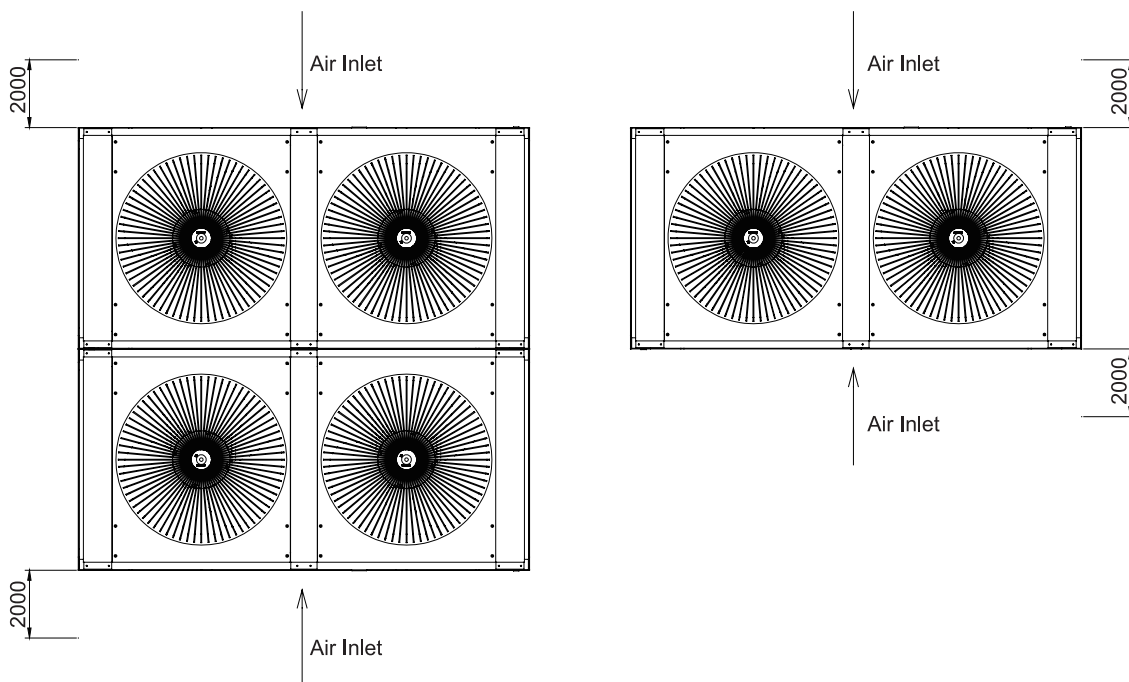

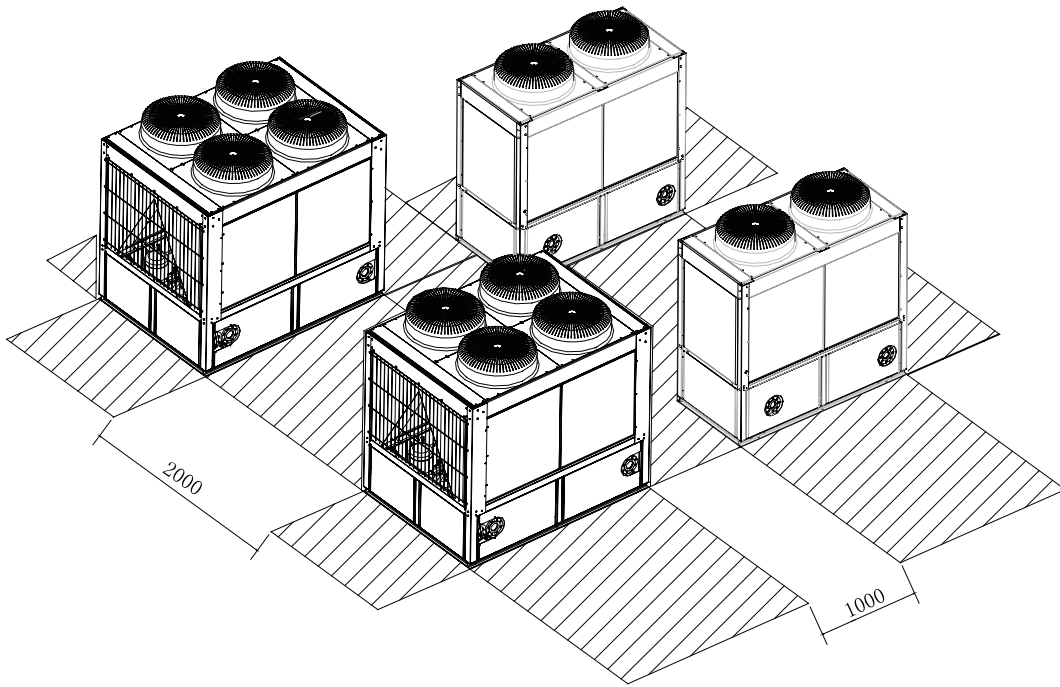

6 TYPICAL WATER PIPING DIAGRAM

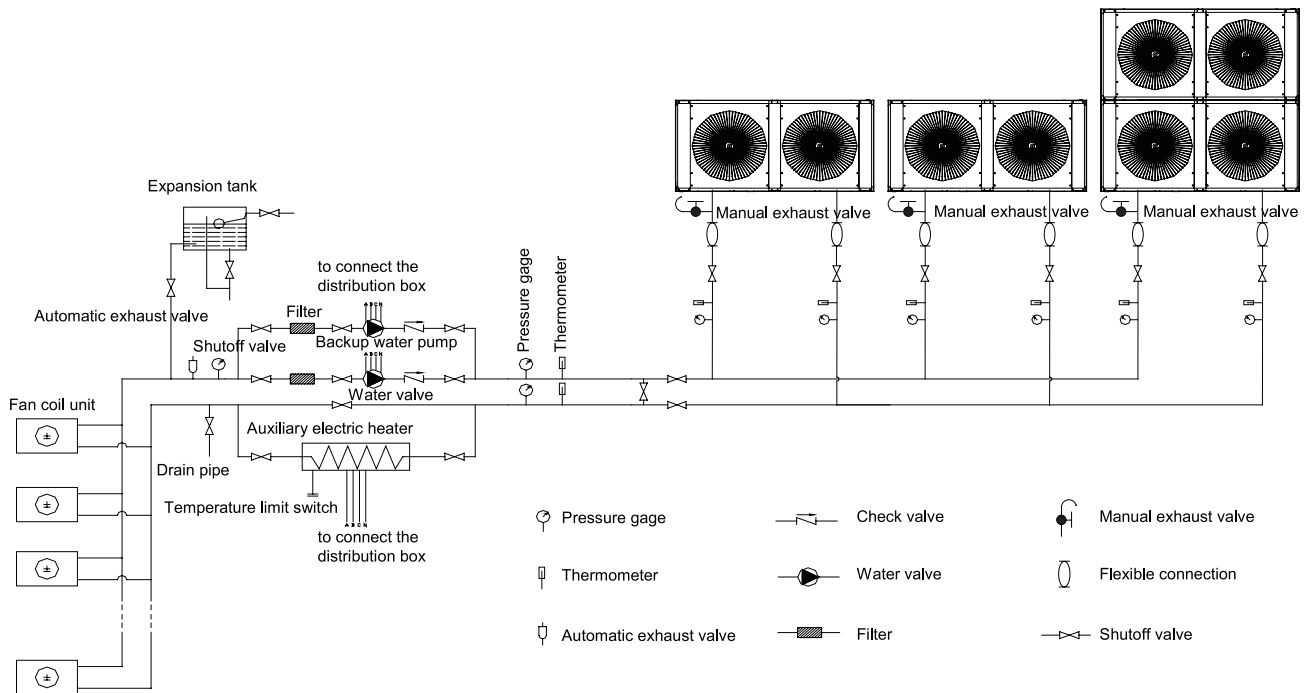

7 FREEZE PROTECTION

When the flow passage of the shell-and-tube heat exchanger is frozen up, it would cause serious damage to the heat exchanger, such as cracking and leakage which are out of warranty, therefore, the user should take measures stated below for freeze protection.

- ◆ Under subzero conditions, it is necessary to shut down the chiller installed outdoor and then drain the evaporator completely.
- ◆ Failure of the chilled water flow switch and the anti-freezing temperature sensor will cause the tube frozen up, so the flow switch shall be interlocked with the chiller.
- ◆ When charging or recovering the refrigerant, the evaporator would crack because of frostbite provided the refrigerant pressure inside the evaporator is under 0.71MPa. Therefore, be sure to keep the water flow continually inside the evaporator or drain it completely.

8 ELECTRIC WIRING WORK

8.1 Wiring Principle

- ◆ All wiring shall comply with applicable codes and engineering requirements.
- ◆ All field wiring shall be performed by the qualified electrician.
- ◆ Never perform wiring before the power supply is cut off.
- ◆ Any damage caused by the improper external wiring shall be at the installer's expense.

WARNING: only copper conductor is allowed.

(1). Power Cord Routing into the Electric Box

- ◆ The power cord is wired into the internal electric box.
- ◆ The power cord must be routed inside the conduit.
- ◆ The power cord must enter the electric box through a rubber or plastic ring to avoid any damaged caused by the sharp edge of the metal sheet.
- ◆ The power cord close to the electric box must be attached securely to prevent the terminal block of the electric box affected by the outside force.

(2). Control Line

- ◆ The field supplied control line shall be at a minimum 1mm².
- ◆ What the flow switch receives is the DC low-voltage signals. The wiring of the flow switch shall not be parallel with the 50V or higher line. If inevitable, the hi-voltage and low-voltage signals must keep a distance of at least 150mm.
- ◆ The electric box will send the control signal (220 AC, 5A) to control the chilled water pump and auxiliary electric heater, however, never do not drive them directly through the control signal but through their AC contactors.
- ◆ A reasonable length of the control line should be left outside the unit and the rest should be bundled and fed into the electric box.

8.2 Wiring between Chiller Modules

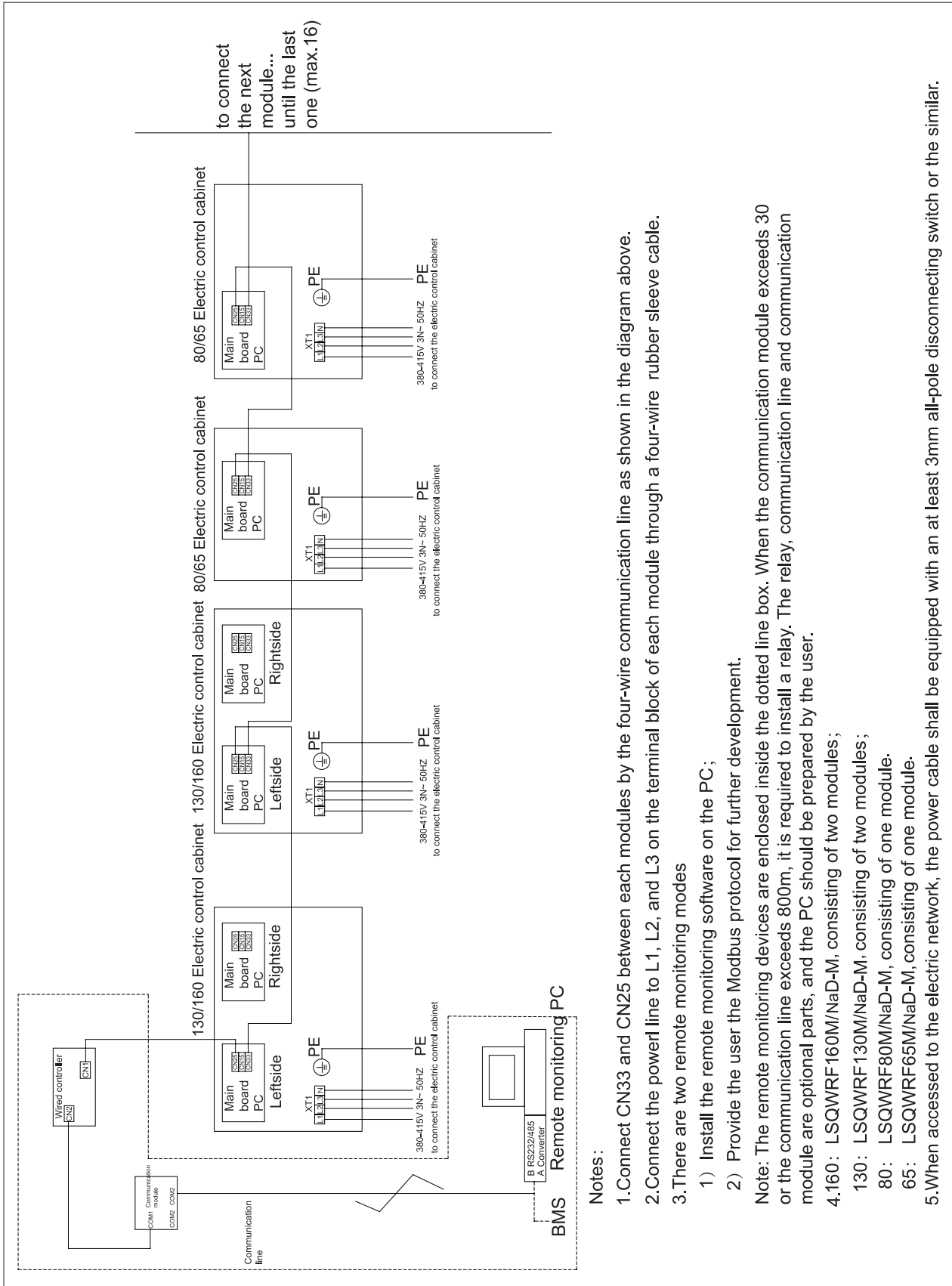

8.3 Specification of Power Cord and Air Switch

Model	Power Supply	Min. sectional area of the power cable (mm ²)			Capability of the Air Switch(A)
		Live Line	Neutral Line	Earth Line	
LSQWRF65M/NaD-M	380-415V,3Ph,50Hz	16	4	16	63
LSQWRF80M/NaD-M		25	4	16	80
LSQWRF130M/NaD-M		50	4	25	125
LSQWRF160M/NaD-M		70	4	35	160

Notes:

- The specifications of the minimal size of the neural line should be 4mm², that is, the selected size of the neutral line should be equal to or larger than 4mm².
- The specifications of the breaker and power cable listed in the table above are determined based on the maximum power (maximum amps) of the unit.
- The specifications of the power cable listed in the table above are applied to the conduit-guarded multi-wire copper cable (like, JYV copper cable, consisting of PV insulated wires and a PVC cable jacket) used at 40°C and resistible to 90°C (see IEC60364-5-523:1999). If the working condition changes, they should be modified according to the related national standard.
- The specifications of the breaker listed in the table above are applied to the breaker with the working temperature at 40°C. If the working condition changes, they should be modified according to the related national standard.

8.4 WIRING DIADRAM

(1). LSQWRF65M/NaD-M

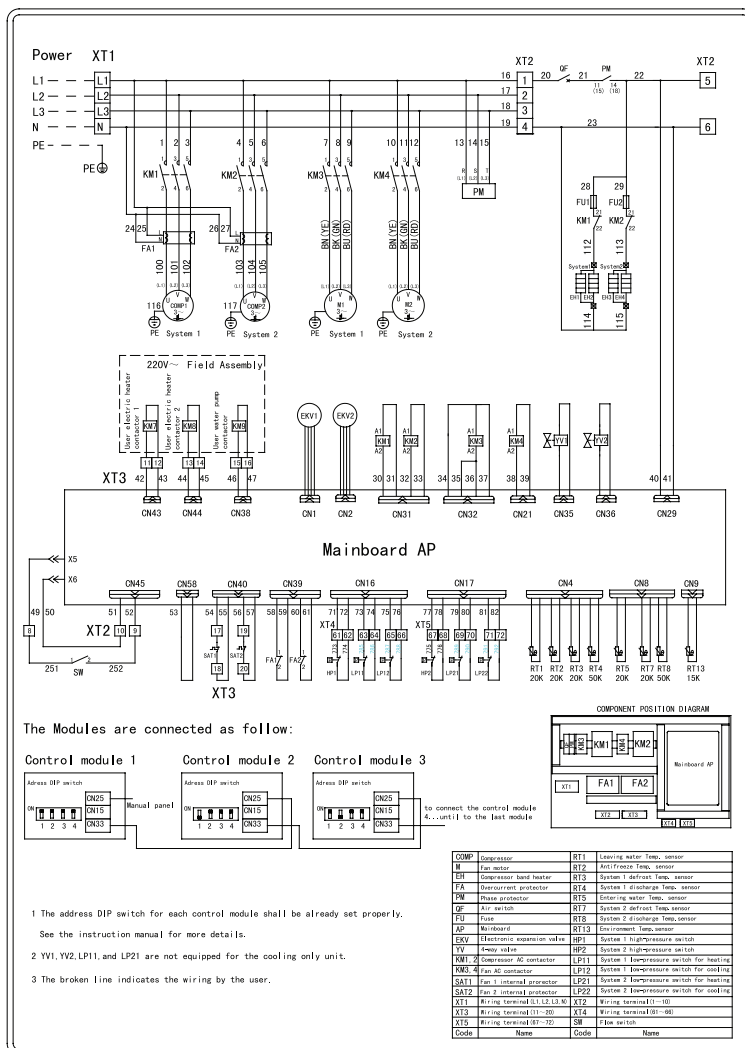

The diagram is only for reference and the circuit diagram attached on the unit prevails.

(2). LSQWRF80M/NaD-M

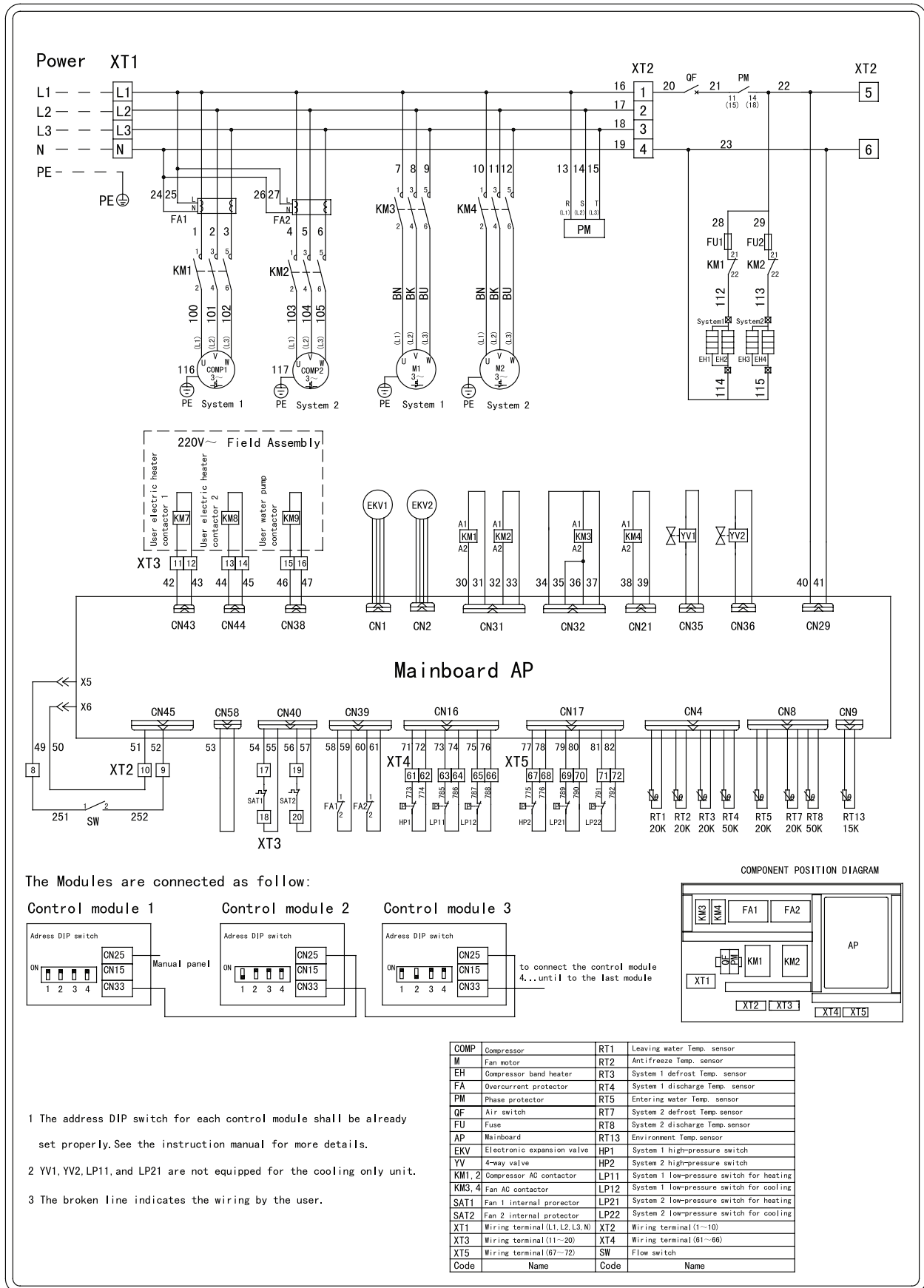

The diagram is only for reference and the circuit diagram attached on the unit prevails.

(3). LSQWRF130M/NaD-M

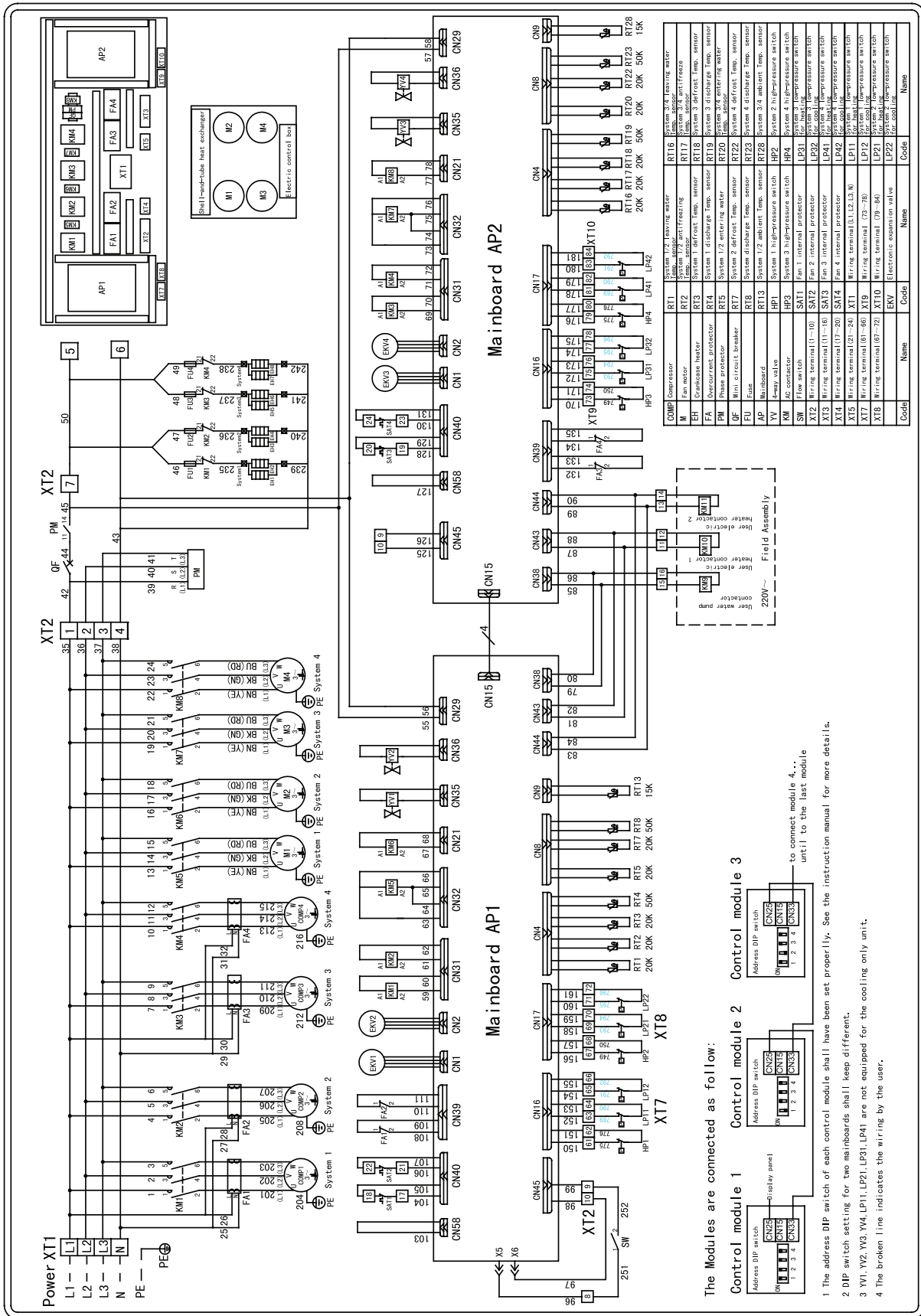

The diagram is only for reference and the circuit diagram attached on the unit prevails

The Modules are connected as follow:

Control module 1

Control module 2

Control module 3

1 The address DIP switch of each control module shall have been set properly. See the instruction manual for more details.

2 DIP switch setting for two mainboards shall keep different.

3 YV1, YV2, YV3, YV4, LP1, LP2, LP3, LP4 are not equipped for the cooling only unit.

4 The broken line indicates the wiring by the user.

(4). LSQWRF160M/NaD-M

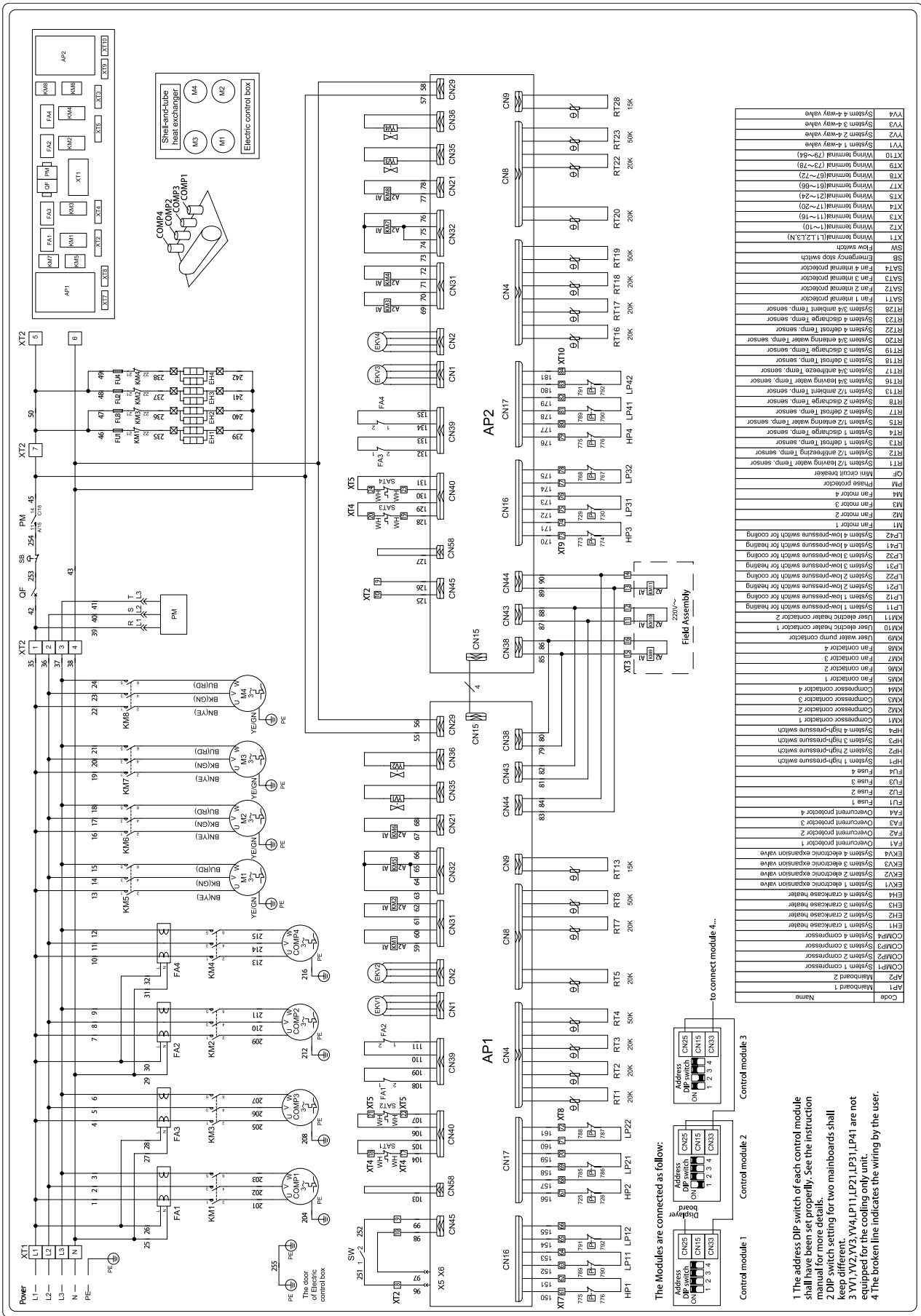

MAINTENANCE



MAINTENANCE

1 ERROR LIST

Error	Rated Element	Protection Logic
High-pressure protection	High pressure switch	When the pressure is too high or the current exceeds the set point, the corresponding compressor will stop and the indicating LED on the control panel will light on and the error information will be displayed on the error log which must be manually cleared for normal operation of next time.
Compressor over-current protection	Over-current protector	
Low pressure protection	Low-pressure switch	When it is detected the low-pressure switch of the compressor is opened frequently, the compressor will be shut down immediately. Meanwhile, the error information will be displayed among the error log which must be manually cleared for normal operation of next time.
High discharge protection	Discharge temperature sensor	When it is detected in three consecutive seconds that the discharge temperature exceeds the set point, the compressor will be shut down immediately. Meanwhile, the error information will be displayed among the error log which must be manually cleared for normal operation of next time.
Fan over-current protection	Fan over-current protector	When a fan is over-current, the corresponding unit will be shut down. Meanwhile, the error information will be displayed among the error log which must be manually cleared for normal operation of next time.
Temperature sensor protection	Temperature sensor	When an entering water temperature sensor fails, the compressor of the corresponding module will be shut down immediately while the fan will still run for some time. When a discharge temperature sensor fails, or the sensed discharge temperature is always below the set point, the compressor of the corresponding module will be shut down immediately. It can recover in three seconds but if the same case occurs more than three times, the system will be locked until the system is unlocked and then it should be manually cleared for normal operation of next time. When the anti-freezing temperature sensor or the leaving water temperature sensor fails, it can be automatically cleared as the temperature sensor automatically recover. But if the same case occurs three times in one hour or the temperature sensor fails to recover, it should be manually cleared for normal operation of next time. Meanwhile, the indicating LED on the control panel will light on and the error information will be displayed on the error log.
Water flow switch protection	Contactator	When a single module detects its flow switch is closed, this module will automatically be shut down. When all flow switches are closed, the water pump will stop.
Phase loss/reversal protection	Phase protector	When phase loss/reversal occurs, the phase protector will cut off the power supply to the main board.
Communication error	Main board	When the single module fails to receive signals from the control panel, it will automatically be shut off.

2 FLOW CHART OF TROUBLESHOOTING

(1). High pressure protection

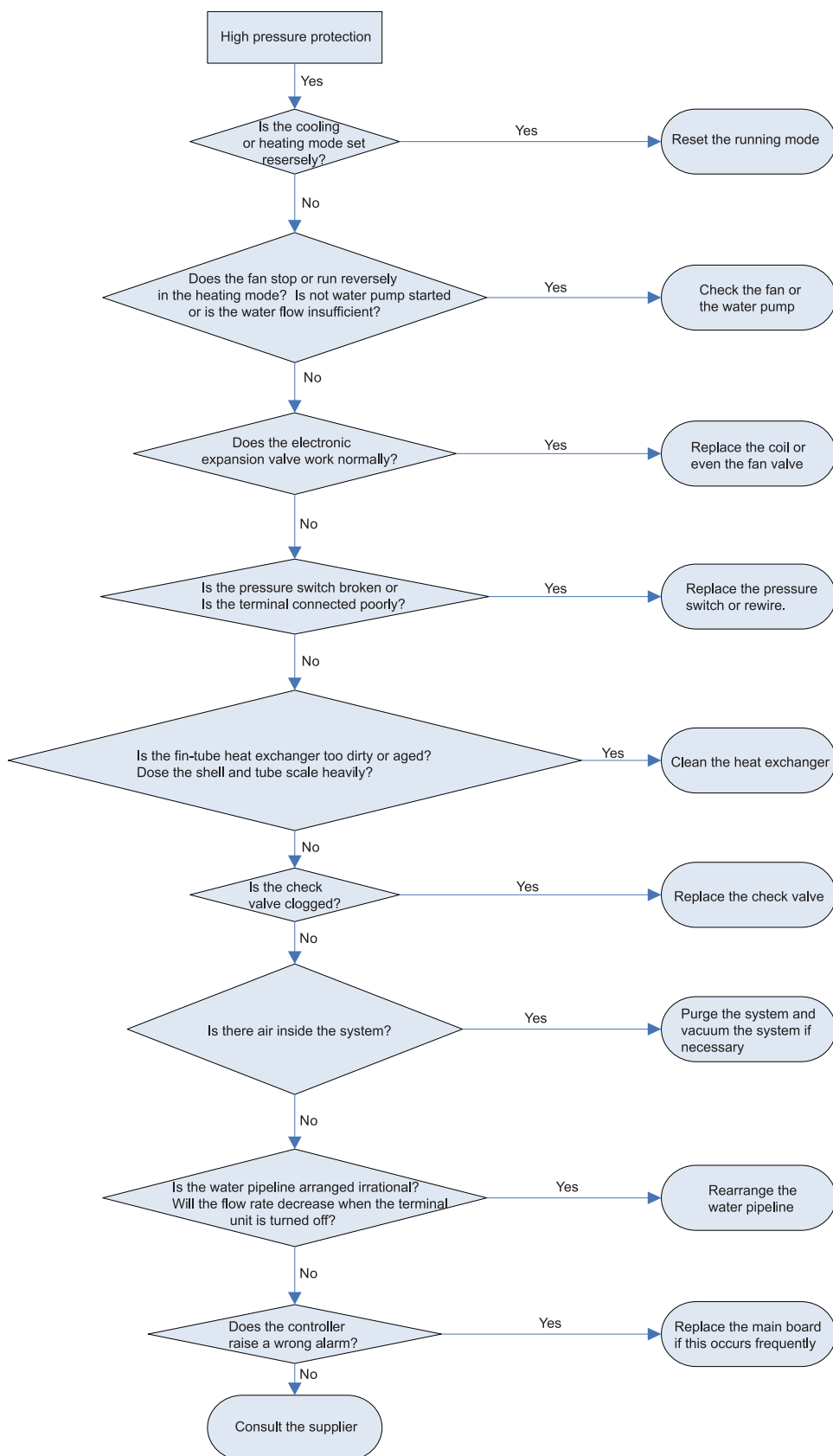



(2). Low pressure protection

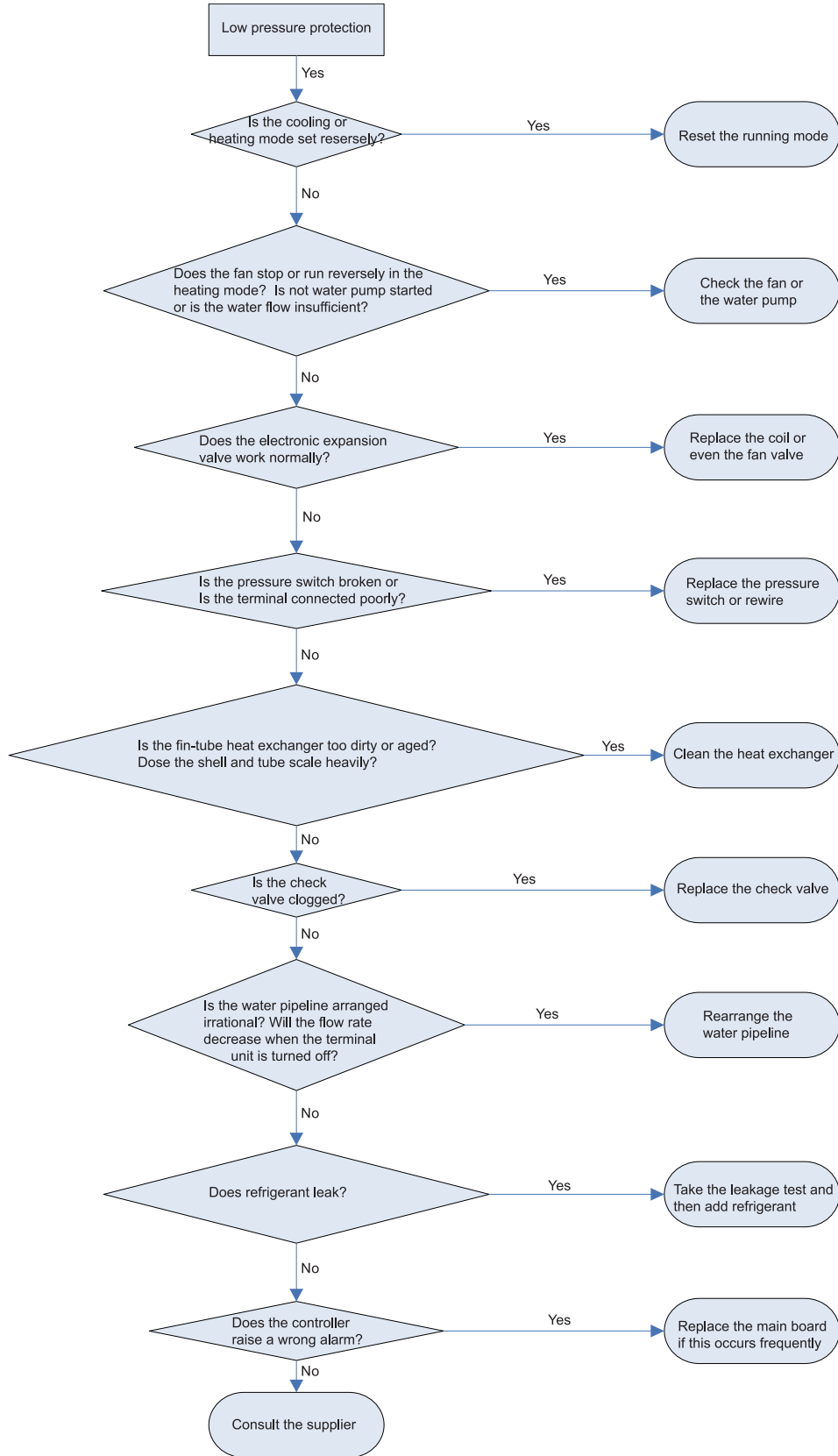

(3). High discharge protection

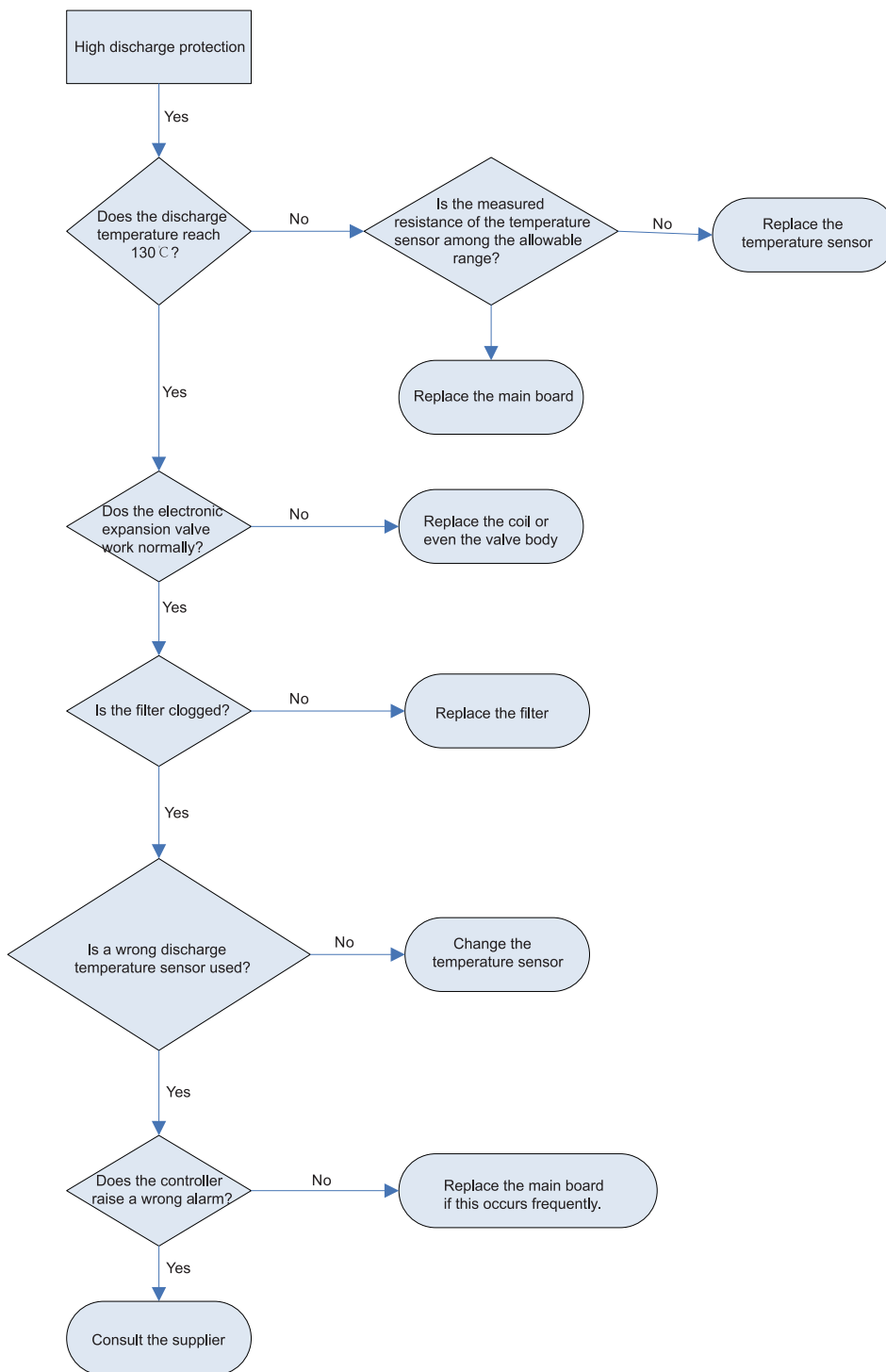



(4). Compressor over-load protection

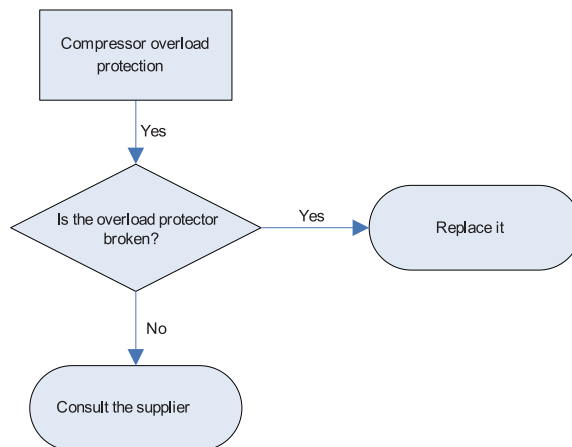

(5). Phase protection

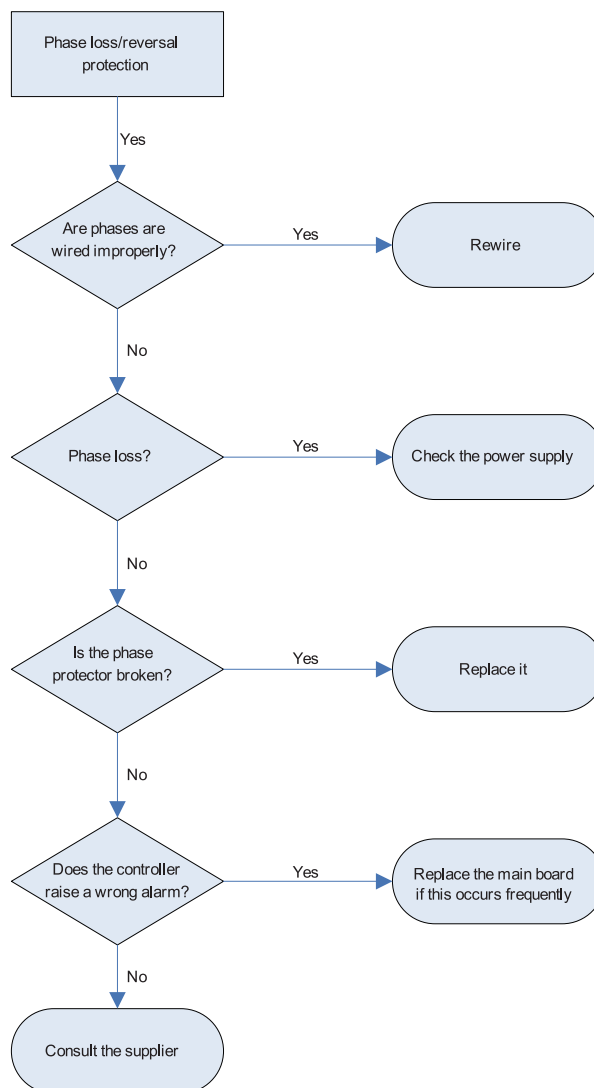

(6). Water flow switch protection

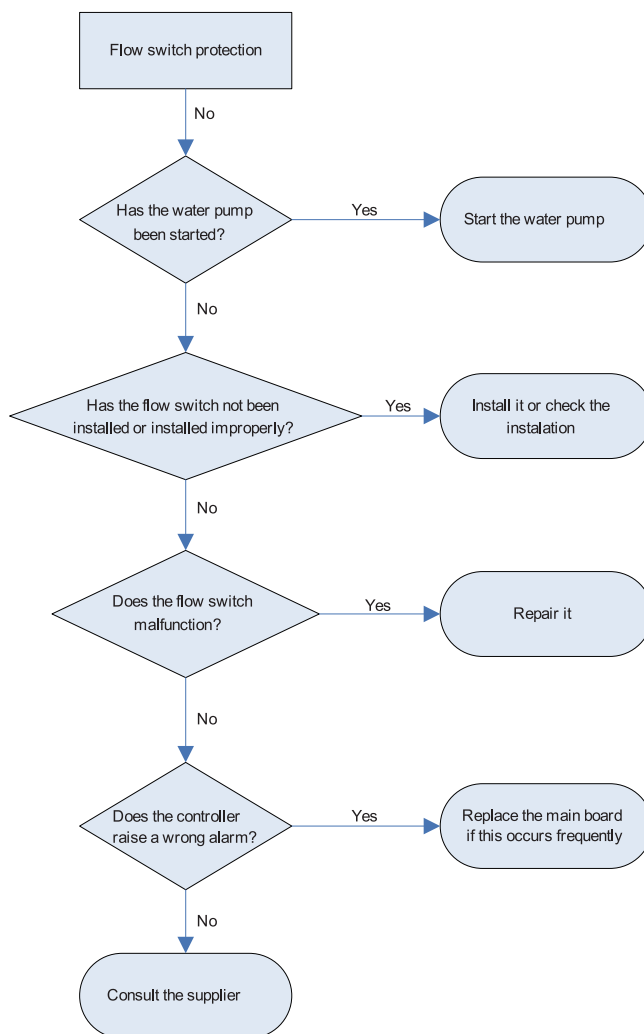



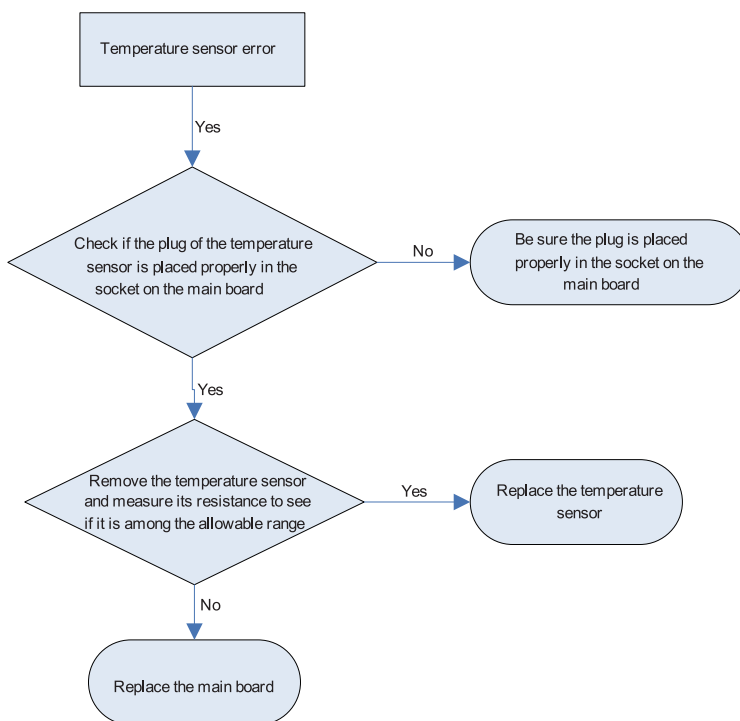



(7). Temperature sensor error



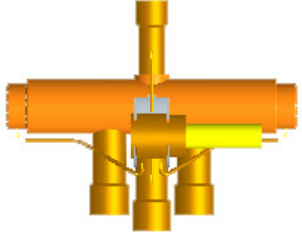

3 REMOVALS AND REINSTALLATION

3.1 MAIN PARTS

Appearance	Name	Function
	Compressor	It drives the refrigerant cycle and turns the low-temperature, low pressure refrigerant vapor into high-temperature, high-pressure vapor.
	Accumulator	It is used to separate oil and refrigerant liquid from the refrigerant vapor.
	4-way Valve	It is used to shift the direction of the refrigerant flow to realize either cooling or heating.
	Shell-and-tube heat exchanger	In the cooling mode, it is used to absorb heat and evaporate the liquid refrigerant In the heating mode, it is used to release heat and condense the refrigerant vapor.
	Fintube heat exchanger	In the cooling mode, it is used to absorb heat and evaporate the liquid refrigerant In the heating mode, it is used to release heat and condense the refrigerant vapor.
	Electronic expansion valve	It is used to regulate the flow rate of the refrigerant to make it perfectly match with the load in need.

3.2 Removal and Installation of Main Parts

Compressor

(These steps listed below are applicable to the dual-system unit. For the four-system unit, please first remove the electric boxes of two compressors in between and then follow the steps below.)

Note: Be sure there is no refrigerant in the pipeline system and the power supply is cut off.

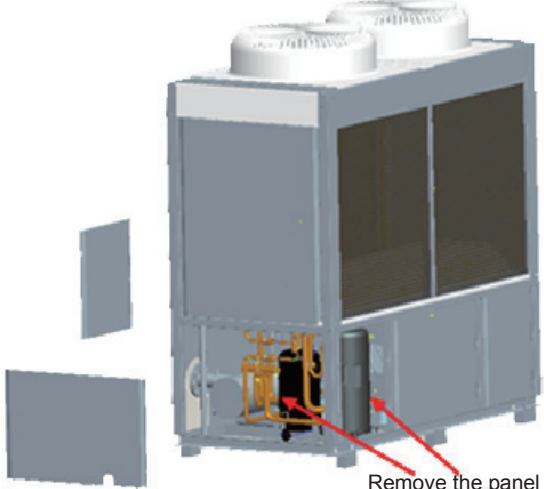
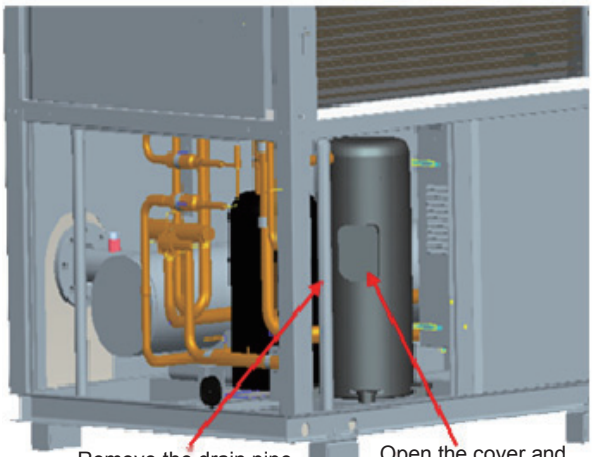
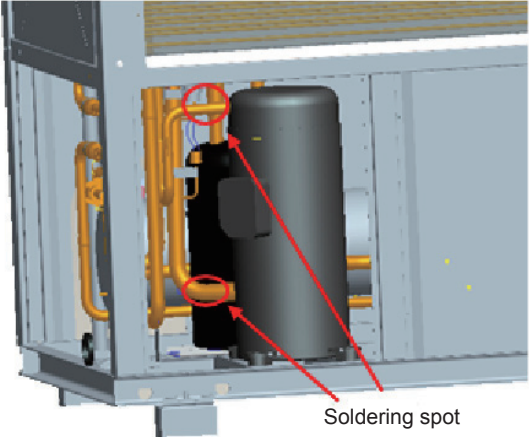
Steps	Graphic Representation	Instructions
<p>1. Remove the panel</p>	 <p>Remove the panel here</p>	<ul style="list-style-type: none"> ◆ Loosen screws around the panel with a screwdriver. ◆ Remove the panel. ◆ Collect the screws in case of loss. ◆ Place the panel in the right place to avoid inadvertent damage.
<p>2. Remove the power cord and drain pipe</p>	 <p>Remove the drain pipe Open the cover and remove the power cord</p>	<ul style="list-style-type: none"> ◆ Loosen screws for the power cord with a screwdriver. ◆ Draw out the power cord. ◆ Remove the crankcase heater, if applicable. ◆ Remove the drain pipe. <p>Note: when removing the power cord, mark the color of the power cord and the code of the wiring terminal to avoid misconnection.</p>
<p>3. Separate the compressor from the pipeline system</p>	 <p>Soldering spot</p>	<ul style="list-style-type: none"> ◆ Unbrazing the brazing spots of the pipeline as quick as possible. ◆ Minimize damage on the compressor for further analysis.

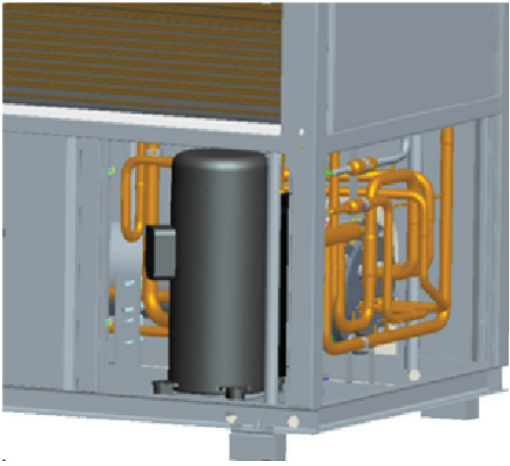
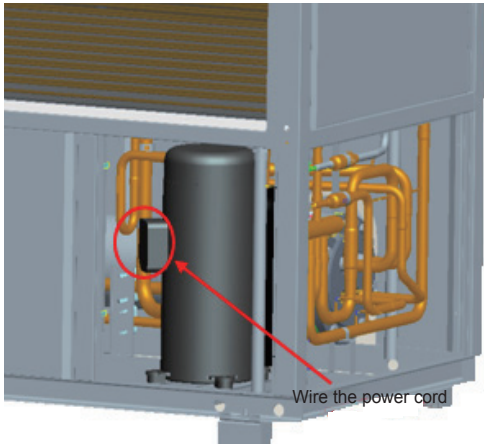

<p>4. Loose screws at the base of the compressor</p>		<ul style="list-style-type: none"> ◆ Remove screws with an adjustable wrench or a socket wrench. ◆ Collect screws in case of loss.
<p>5. Replace the compressor</p>		<ul style="list-style-type: none"> ◆ Remove the compressor and do not damage the rubber pad. ◆ Package the removed compressor to prevent moisture entering. ◆ Place a new compressor at the base. ◆ Tighten screws.
<p>6 Connect the pipeline and power cord</p>		<ul style="list-style-type: none"> ◆ Connect the suction and discharge lines to the compressor by brazing. Note that nitrogen shall be charged during brazing. ◆ After brazing, use high-pressure nitrogen for leakage test. ◆ Energize the unit and manually close the AC contactor of the compressor to let the compressor run for 2~3 seconds. ◆ When the compressor runs reversely, sharp sound will generates.

Note: after the compressor is replaced, most amount of oil will still remain in the system, which will not affect the reliability of the newly installed compressor but will increase the running resistance to the rotor and increase electricity consumption. Therefore, a valve should be installed at the lower part of the inlet of the suction line to discharge excessive oil. After installing the valve, start the compressor for ten minutes and then open this valve until all oil flows out completely. Do it twice to guarantee the oil keeps at the normal level.

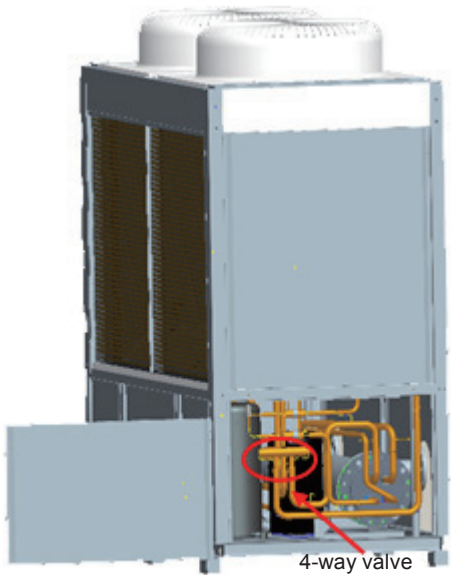
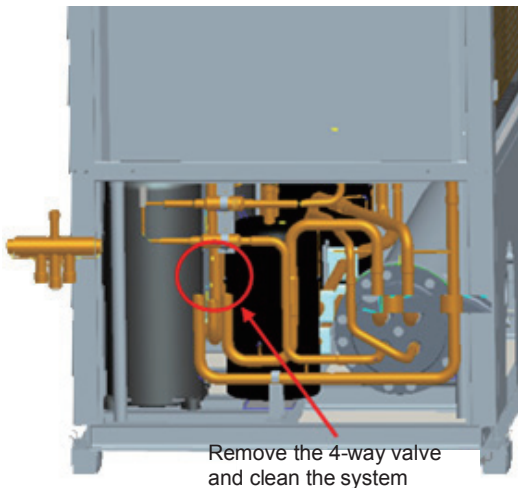
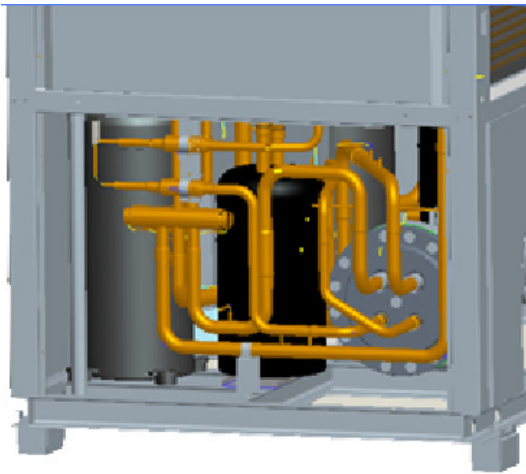
4-way Valve		
Note: Be sure to cut off the power supply and recover the refrigerant firstly		
Steps	Graphic Representation	Instructions
1. Record the installation direction of the 4-way valve	 <p>4-way valve</p>	<ul style="list-style-type: none"> ◆ Remember the installation direction of the 4-way valve before removal. ◆ Remove the coil. ◆ Wrap the 4-way valve prior to unbrazing to prevent it from being damaged and use it for future analysis. ◆ Unbraid the 4-way valve.
2. Clean the system, replace the 4-way valve and reconnect the pipeline as before	 <p>Remove the 4-way valve and clean the system</p>	<ul style="list-style-type: none"> ◆ Replace the 4-way valve with the same model, or that approved by the qualified technician. ◆ Wrap the 4-way valve with wet cloth. ◆ Reconnect the connection pipe as before. ◆ Braid the pipeline. ◆ Charge nitrogen when unbrazing.
3. Vacuum the system and charge refrigerant again		<ul style="list-style-type: none"> ◆ Vacuum the system until the pressure goes as low as -1.0bar. ◆ The refrigerant charge and quality shall comply with the specification on the nameplate.



Accumulator		
Note: Be sure to recover the refrigerant, prepare proper devices and tools and keep a good ventilation.		
Steps	Graphic Representation	Instructions
1. Remove the panel as shown in the right figure		<ul style="list-style-type: none"> ◆ Remove the panel as shown in the left figure with a screwdriver.
2. Disconnect the connection pipe of the accumulator		<ul style="list-style-type: none"> ◆ Unbraze the connection pipe of the accumulator.
3. Remove the 4-way valve assembly if necessary		<ul style="list-style-type: none"> ◆ Unbraze the 4-way valve assembly.

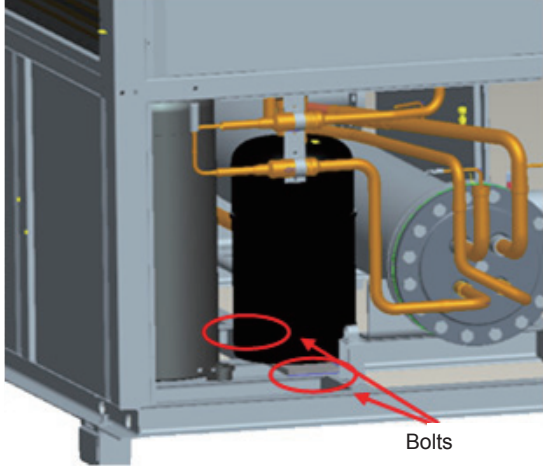
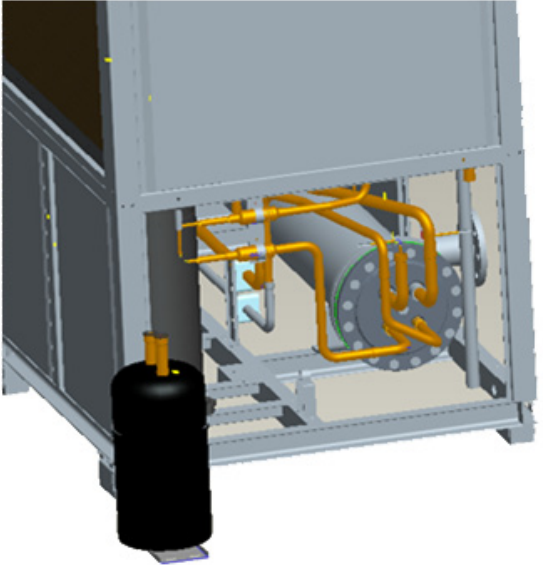
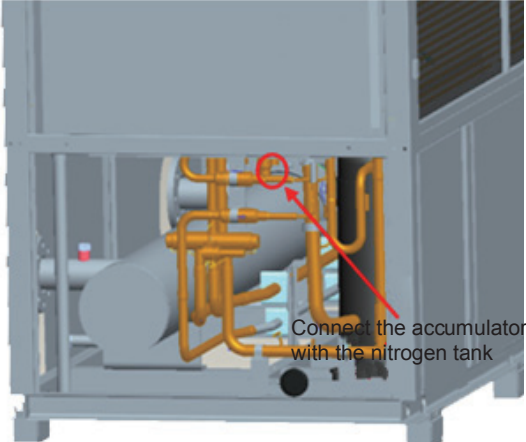

<p>4. Remove the bolts at the base</p>	 <p style="text-align: center;">Bolts</p>	<ul style="list-style-type: none"> ◆ Remove bolts at the base with a wrench.
<p>5. Remove the accumulator.</p>		<ul style="list-style-type: none"> ◆ Remove the accumulator
<p>6. Purge the system by charging nitrogen</p>	 <p style="text-align: center;">Connect the accumulator with the nitrogen tank</p>	<ul style="list-style-type: none"> ◆ Connect the pipeline of the accumulator with the nitrogen tank and adhesive tape can be used for the large-sized pipeline. ◆ Purge the system by charging nitrogen.

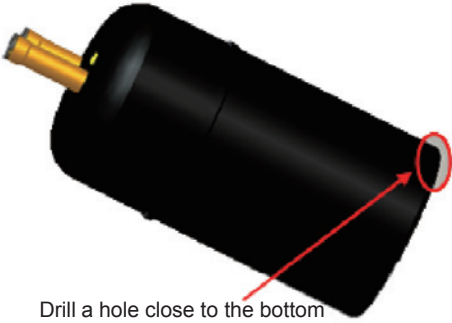
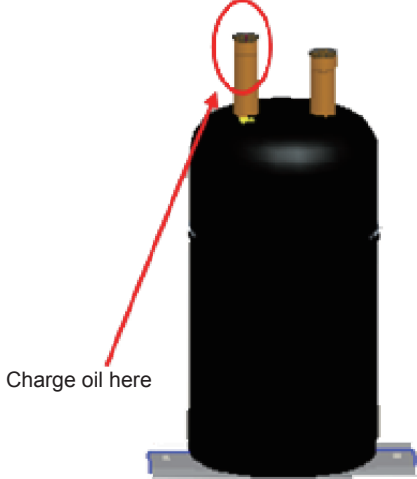
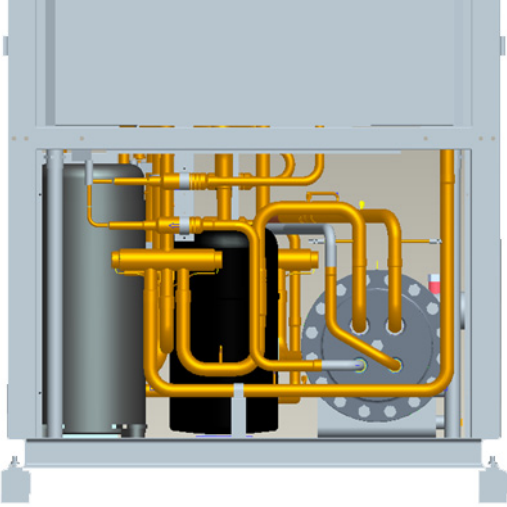

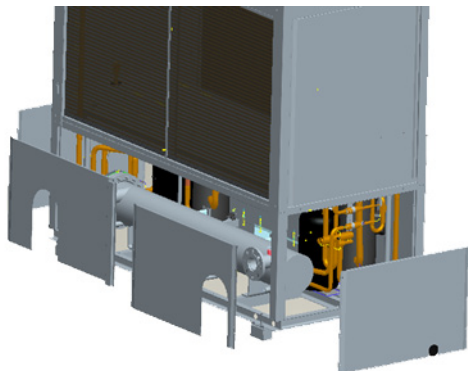
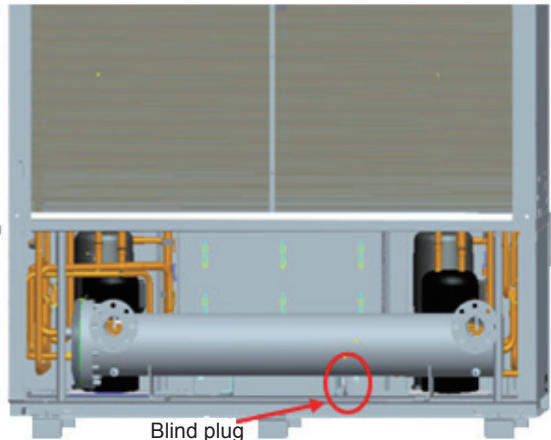
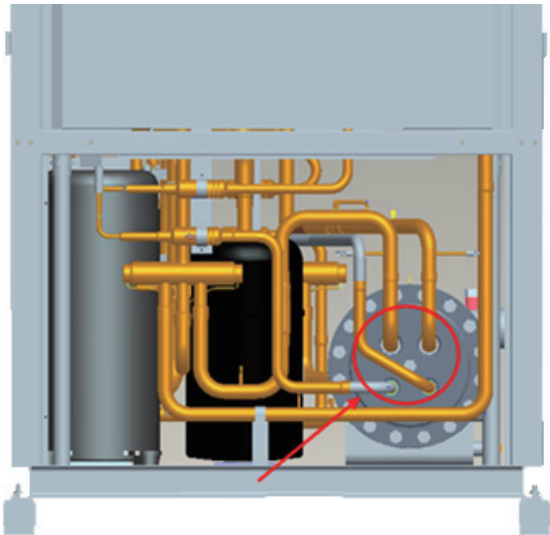
<p>7. Check if oil needs to be added</p>	 <p>Drill a hole close to the bottom</p>	<ul style="list-style-type: none"> ◆ Tilt the accumulator and then drill a hole close to the bottom and then pour the oil inside the accumulator to a prepared container.
<p>8. Add oil if necessary</p>	 <p>Charge oil here</p>	<ul style="list-style-type: none"> ◆ Charge oil to the accumulator prior to brazing.
<p>9. Reconnect the connection pipe of the accumulator and vacuum the system and then charge refrigerant again</p>		<ul style="list-style-type: none"> ◆ Charge nitrogen when brazing. ◆ Vacuum the system until the pressure goes as low as -1.0bar. ◆ The refrigerant charge and quality shall comply with the specification on the nameplate.

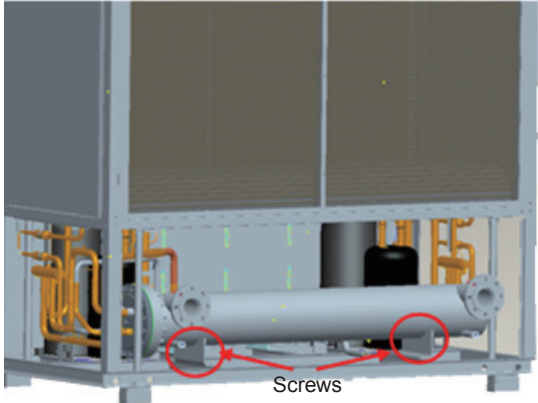
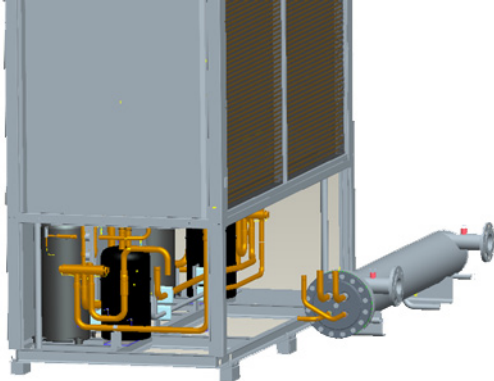

Shell-and-tube Heat Exchanger		
Note: Check the water system and be sure the shell-and-tube heat exchanger shall be replaced. And then cut off the power and recover the refrigerant.		
Steps	Graphic Representation	Instructions
1. Remove the panel as shown in the right figure		<ul style="list-style-type: none"> ◆ Remove four panels around the heat exchanger and the frame in front of the blind plug.
2. Loosen the pipeline connectors and remove the panel outside of the heat exchanger	 <p>Blind plug</p>	<ul style="list-style-type: none"> ◆ Remove the pipeline ◆ Remove the metal sheets located underside with a screwdriver. ◆ Loosen the blind plug and drain the water inside the pipeline.
3. Unbrazed the pipeline connecting the heat exchanger. (Different heat exchangers vary in structure so it is better to remember the piping location to prevent misconnection)		<ul style="list-style-type: none"> ◆ Wrap the copper pipe with wet cloth. ◆ Unbrazed the pipelines connecting the heat exchanger.

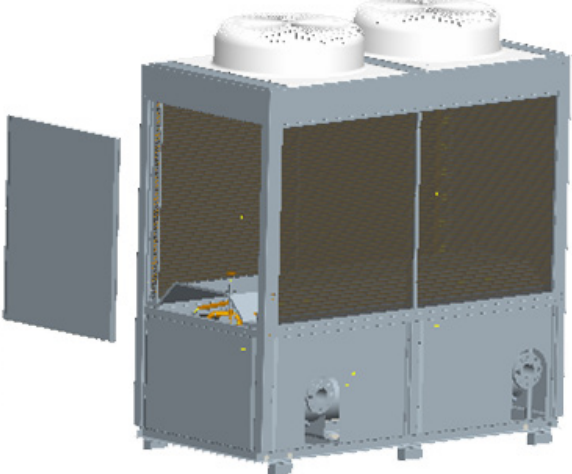
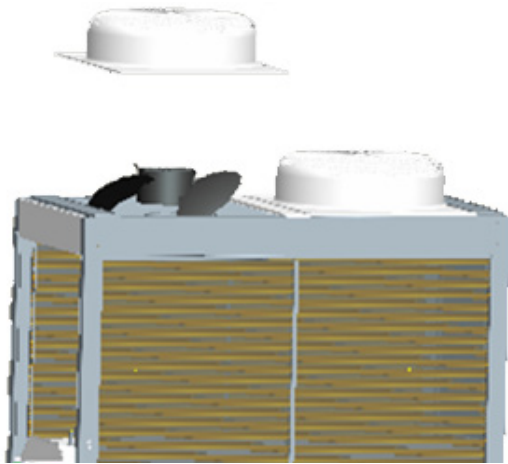
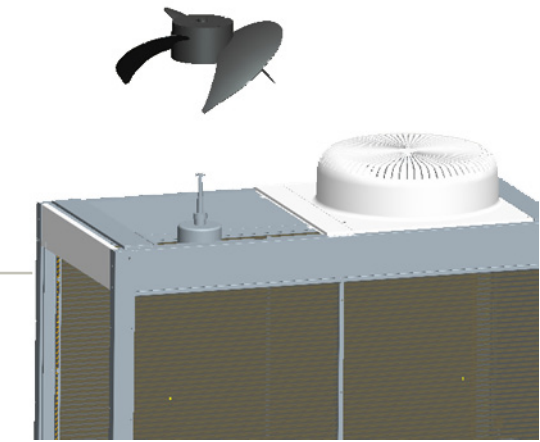

<p>4. Loosen four screws fixing the heat exchanger</p>		<ul style="list-style-type: none"> ◆ Loosen four screws fixing the heat exchanger with a screwdriver.
<p>5. Remove the shell-and-tube heat exchanger</p>		<ul style="list-style-type: none"> ◆ Remove the shell-and-tube heat exchanger.
<p>6. Place a new heat exchanger and connect the pipeline and then vacuum the system and lastly charge refrigerant</p>		<ul style="list-style-type: none"> ◆ Replac the heat exchanger with the same model. ◆ Wrap the cooper pipe with wet cloth and braze the pipeline. ◆ Vacuum the system until the pressure goes as low as -1.0bar. ◆ The refrigerant charge and quality shall comply with the specification on the nameplate. ◆ Connect the water pipeline. ◆ Put the metal sheets back.

Fan		
Note: Be sure to cut off the power supply firstly		
Steps	Graphic Representation	Instructions
1. Remove the panel as shown in the right figure		<ul style="list-style-type: none"> ◆ Remove the panel as shown in the left figure.
2. Remove the guard cover		<ul style="list-style-type: none"> ◆ Remove the guard cover with a wrench.
3. Remove the fan blades		<ul style="list-style-type: none"> ◆ Remove the fan blades with a screwdriver.

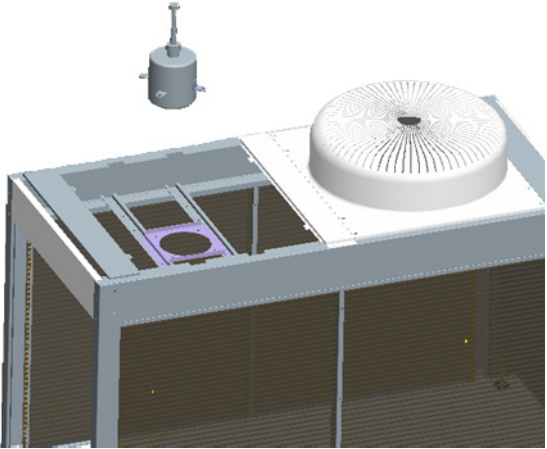
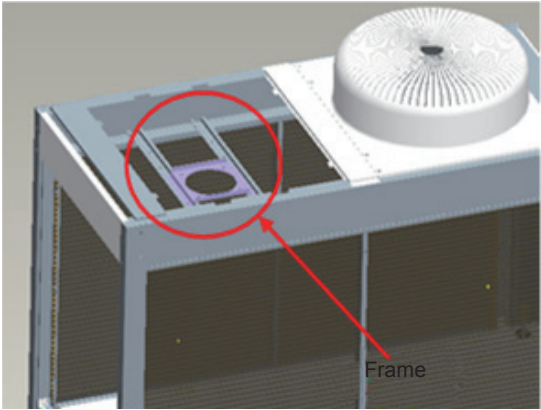

<p>4. Remove the motor</p>		<p>◆ Remove the motor with a wrench.</p>
<p>5. Remove the frame</p>		<p>◆ Remove the frame.</p>
<p>6. Reinstall the fan assembly</p>		<p>◆ Reinstallation sequence: 1. frame; 2. motor; 3. fan blades; 4. guard cover; 5. panel.</p>

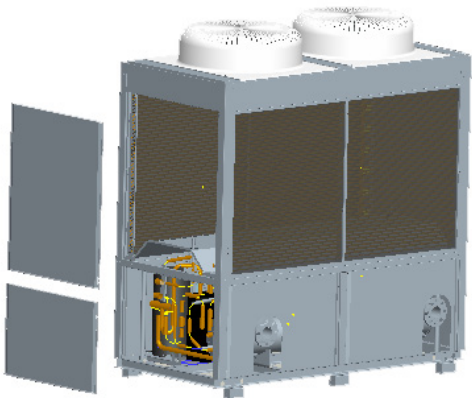
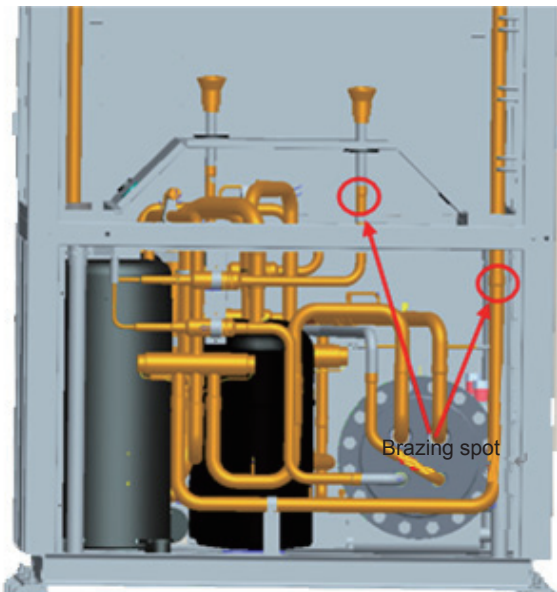
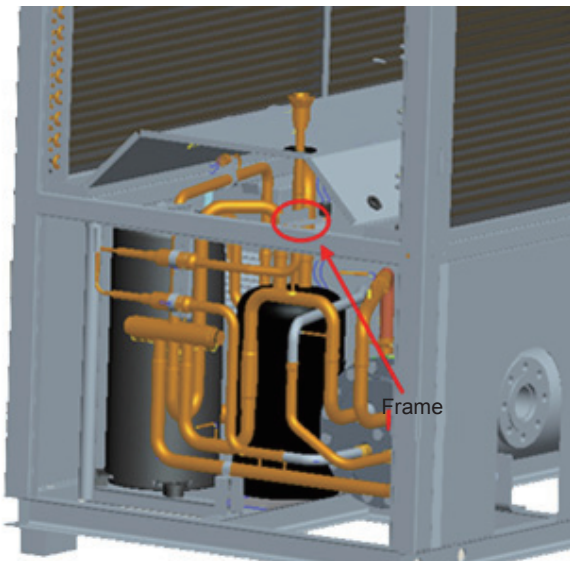
Fintube Heat Exchanger		
Note: Be sure to cut off the power supply and recover the refrigerant firstly.		
Steps	Graphic Representation	Instructions
1. Remove the panel as shown the right figure		<ul style="list-style-type: none"> ◆ Recover refrigerant completely. ◆ Cut off the power supply. ◆ Remove the fan assembly and draw out the power cord of the fan motor and then remove the metal sheets outside the condenser. <p>Note: remember the wiring sequence of the fan motor.</p>
2. Unbraid the inlet/outlet pipeline of the heat exchanger. Do not damage the fins and metal sheets during unbrazing		<ul style="list-style-type: none"> ◆ Unbraid the pipeline of the condenser.
3. Remove the frame of the header and screws and bolts on the heat exchanger		<ul style="list-style-type: none"> ◆ Remove the frame of the header with a wrench. ◆ Remove screws and bolts on the heat exchanger.





<p>4. Place a new heat exchanger and vacuum the system and then charge refrigerant and lastly put the fan and metal sheets back</p>		<ul style="list-style-type: none"> ◆ Install a new heat exchanger. ◆ Braze the pipeline. ◆ Vacuum the system until the pressure is as low as -1.0bar. ◆ The refrigerant charge and quality shall comply with the specification on the nameplate. <p>Take care to the wiring sequence when rewiring the fan motor.</p>
---	---	---

Electronic Expansion Valve

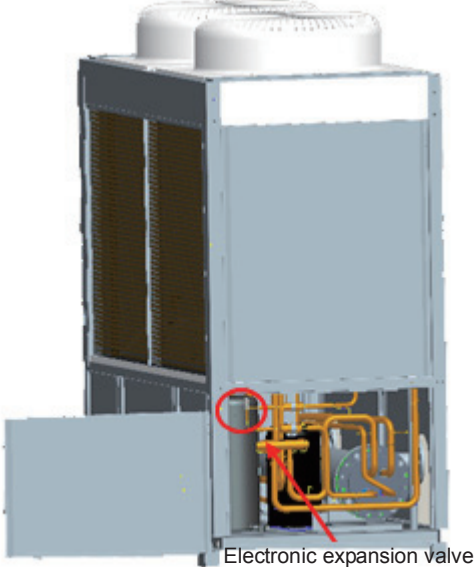
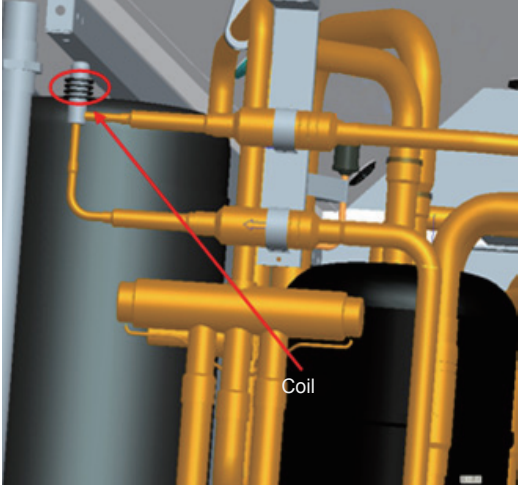
Note: check the refrigeration system and be sure the electronic expansion valve shall be replaced, and then cut off the power supply and recover the refrigerant.

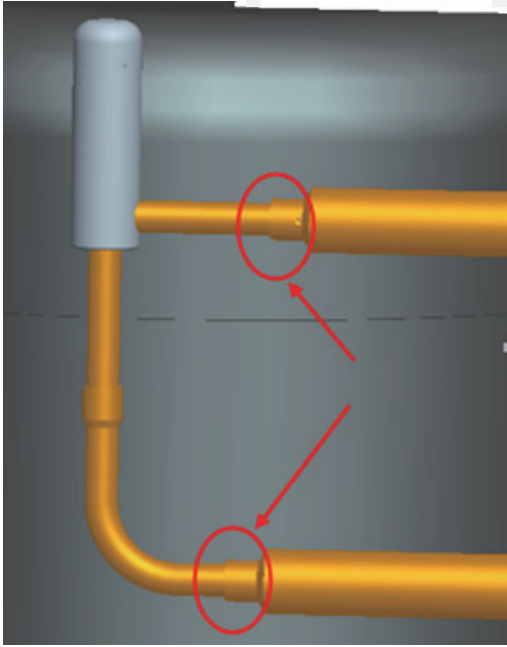
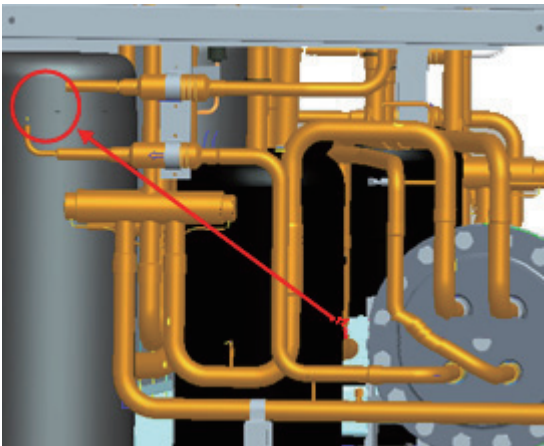
Steps	Graphic Representation	Instructions
<p>1. Recover the refrigerant and remove the panel</p>	 <p>Electronic expansion valve</p>	<ul style="list-style-type: none"> ◆ Cut off the power supply ◆ Recover the refrigerant. ◆ Remove the panel.
<p>2. Remove the electronic expansion valve coil.</p>	 <p>Coil</p>	<ul style="list-style-type: none"> ◆ Wrap the valve with wet clothe to prevent the slide block from being burnt down and never the let water flow into the pipeline.

<p>3 Remove the connection pipe of the electronic expansion valve</p>		<ul style="list-style-type: none"> ◆ Unbrazed the electronic expansion valve ◆ Charge nitrogen during brazing. ◆ Take care to prevent surrounding item from being burnt down owing to high temperature during brazing.
<p>4. Remove the electronic expansion valve</p>		<ul style="list-style-type: none"> ◆ Remove the electronic expansion valve.
<p>5. Place a new electronic expansion valve</p>		<ul style="list-style-type: none"> ◆ Braze each pipeline. ◆ Charge nitrogen during brazing. ◆ Take care to prevent surrounding item from being burnt down owing to high temperature during brazing.

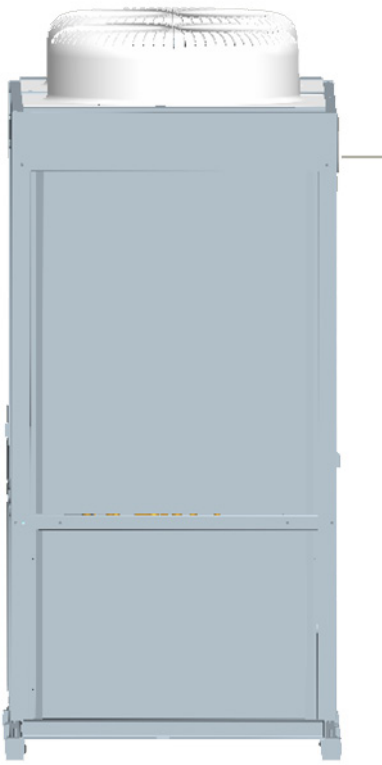

<p>6. Reinstall the electronic expansion valve coil and vacuum the system and then charge refrigerant and lastly put the panel back</p>		<ul style="list-style-type: none"> ◆ The coil shall be matched with the valve body exactly. ◆ The degree of vacuum shall be kept as low as -1.0 bar. ◆ The refrigerant charge and quality shall comply with the specification on the nameplate. ◆ After replace the electronic expansion valve, energize the unit again. ◆ Reinstall the panel.
---	---	--

4 ROUTINE MAINTENANCE

Routine maintenance shall be performed by the skilled and qualified servicemen.

(1). Refrigerant Leakage

Suds is usually used for the leakage test by applying it at the spot (soldering spots, valve pistons, connectors) where leakage is probably to occur. During the test, if soap bubbles pop up, it indicates leakage exists and repair is required. If suds fails to work, a electronic leakage detectors is a alternative. Refrigerant charge can be checked by measuring the suction and discharge pressure. Leakage test should be performed wherever leakage occurs or some components of the refrigeration system are replaced.

There are two difference conditions for charging refrigeration stated as below.

◆ Complete charging

In this case, take a leakage test by charging hi-pressure nitrogen (15~20kg) or refrigerant into the system. If soldering is required, note that gas inside the system must be expelled firstly. The whole system must be dried and vacuumed prior to charging.

- a. Connect the manifold gage.
- b. Vacuum the system with a vacuum pump.

Step 1: Expel the hi-pressure nitrogen for leakage test.

Step 2: Connect the pipeline at both the high and low pressure sides of the manifold gage as shown in the figure below. Note that vacuuming shall be taken at both sides. The degree of vacuum will refer to the reading of the manometer at the low side.

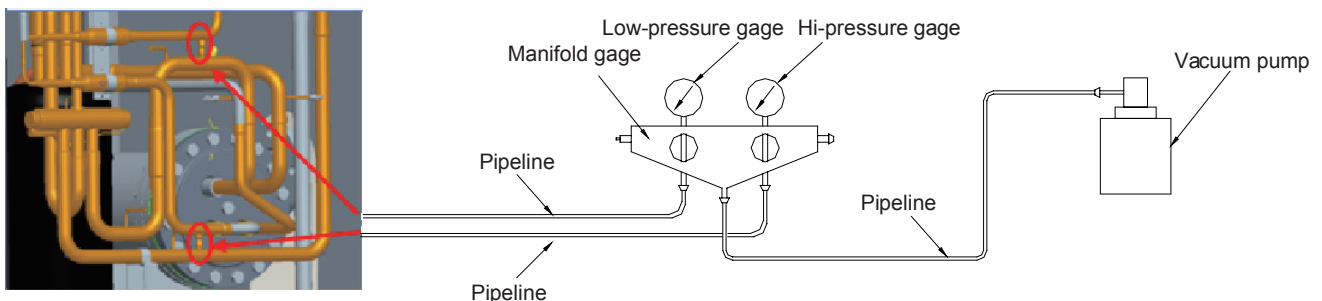

Step 3: Open the valves at both the high-pressure and low-pressure sides and then start the vacuum pump until the gage reading is below -1bar. After that, let the vacuum pump lasts for another 0.5~1.0 hour.

Step 4: Close the valves and stop the vacuum pump. Note that only the valves have been closed can the vacuum pump be stopped, otherwise air is possible to go into the system again.

Step 5: Take the leakage test. Be sure the vacuumed system keeps a pressure no higher than 80Pa and keeps little pressure rise in half an hour.

c. Refrigerant charging starts after the degree of vacuum reaches the expected range and lasts for 30 minutes.

The amount of refrigerant charge shall comply with that specified on the nameplate or product data sheet.

◆ Adding

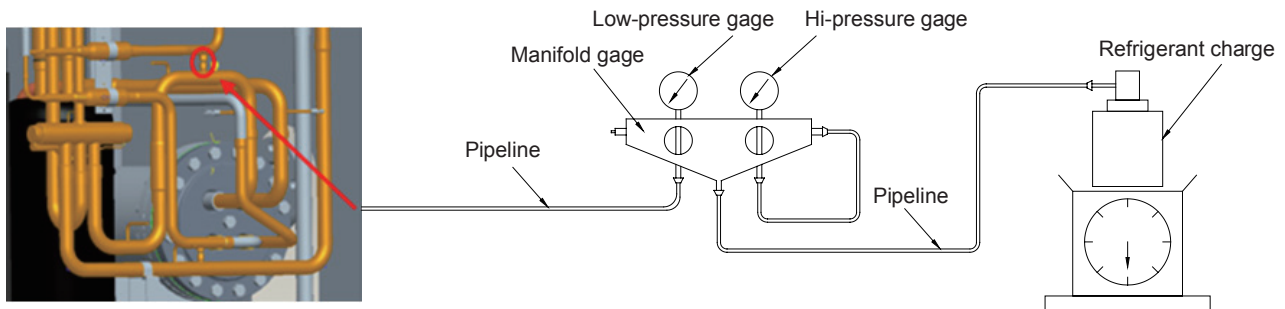

Refrigerant charge is determined through stringent tests, as excess or shortage of refrigerant would cause the compressor to run improperly. Thus, the refrigerant charge shall be consistent with that specified on the nameplate. If refrigerant charge is indeed insufficient, follow the steps below for adding.

Step 1: Weigh the refrigerant tank with an electronic scale and connect the refrigerant tank with the pressure gage through the pipeline.

Step 2: Expel the air inside the pipeline. Firstly half open the shutoff valve of the refrigerant tank and then loosen the connector connecting the pressure gage to expel the air until the connector hisses for five seconds and then tighten the connector.

Step 3: Return the electric scale to zero by energizing it again.

Step 4: Open all valves between the refrigerant tank and the unit to charge refrigerant as per the amount specified on the nameplate. Excessive refrigerant would dilute oil while insufficient refrigerant would lower the refrigeration capability and result in poor lubrication and high discharge temperature etc. Note that only refrigerant vapor can be charged into the system at the low-pressure side when the unit is in operation. However, it is highly recommended to charge refrigerant at the hi-pressure side when the unit is shut down, otherwise it would cause slugging during startup.

(2). Air Purge

Prior to refrigerant charging, it is imperative to expel air inside the system and the system must be vacuumed.

- a. Connect the manifold gage.
- b. Vacuum the system with a vacuum pump.
- c. Charge refrigerant at the low-pressure side as per the amount specified on the nameplate or product data sheet when the degree of vacuum approaches the expected range.
- d. The refrigerant charge will be affected by the ambient temperature. When the charge is under the required amount, it is allowed to add refrigerant vapor after starting the water pump and the unit.



5 EXPLODED VIEWS AND PART LIST

(1). Model: LSQWRF65M/NaD-M

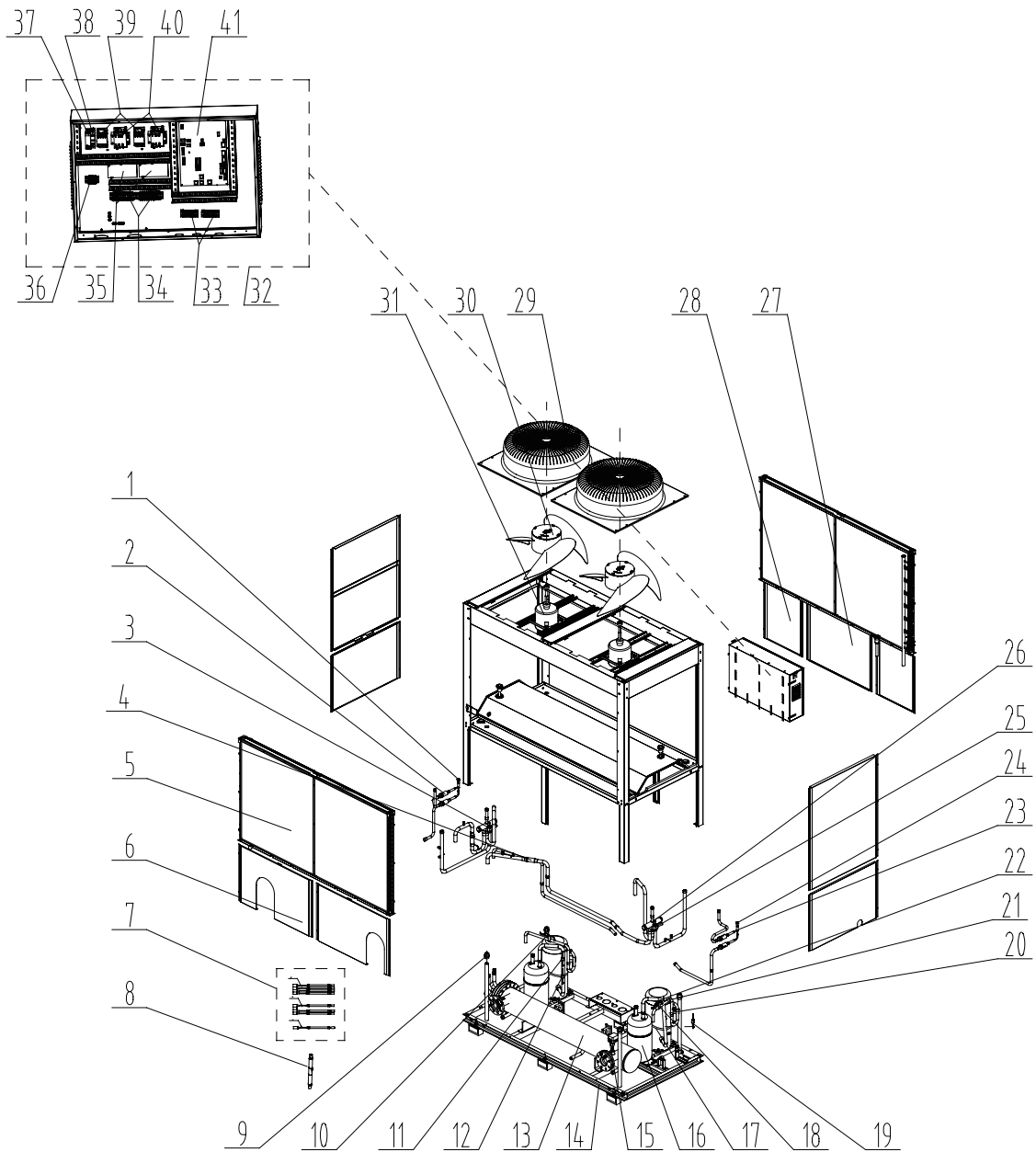

Parts List: LSQWRF65M/NaD-M for EL01500500

No.	Name of part	Part code
1	Electric Expand Valve Fitting	4304413214
2	Strainer	07210037
3	Magnet Coil	4300040064
4	Filter	07218603
5	Condenser Assy	0112110001001
6	Rear Panel	0154110000101P
7	Sensor Sub-assy	39008000004G
8	One Way Valve	0733420001
9	pipe connector	06128301
10	Pressure Protect Switch	4602001570
11	Pressure Protect Switch	4602001581
12	Pressure Protect Switch	4602001583
13	Dry Evaporator	0105887701
14	Base Frame Assy	01281100012P
15	Steam current Switch	45028209
16	Gas-liquid Separator	07424148
17	Electrical Heater	76515211
18	Pressure Protect Switch	4602001569
19	Pressure Protect Switch	4602001579
20	Compressor	00201100002
21	Pressure Protect Switch	4602001582
22	Compressor Gasket	02118049
23	Electronic Expansion Valve	07331139
24	Electric Expand Valve Fitting	4304413213
25	Magnet Coil	4300040048
26	4-way Valve	43000339
27	Front Panel	01541100003P
28	Front Panel	01541100002P
29	Streamlined Dome	22265801
30	Centrifugal Fan	10355801
31	Fan Motor	1570110000101
32	Electric Box Assy	01391100045
33	Terminal Board	42018452
34	Terminal Board	42011135
35	Over Current Protector	46028000011
36	Terminal Board	420102471
37	Phase Reverse Protector	32214101
38	Single-phase Air Switch	45020203
39	AC Contactor	44010235
40	AC Contactor	44010229
41	Main Board	30222000002



(2). Model: LSQWRF80M/NaD-M

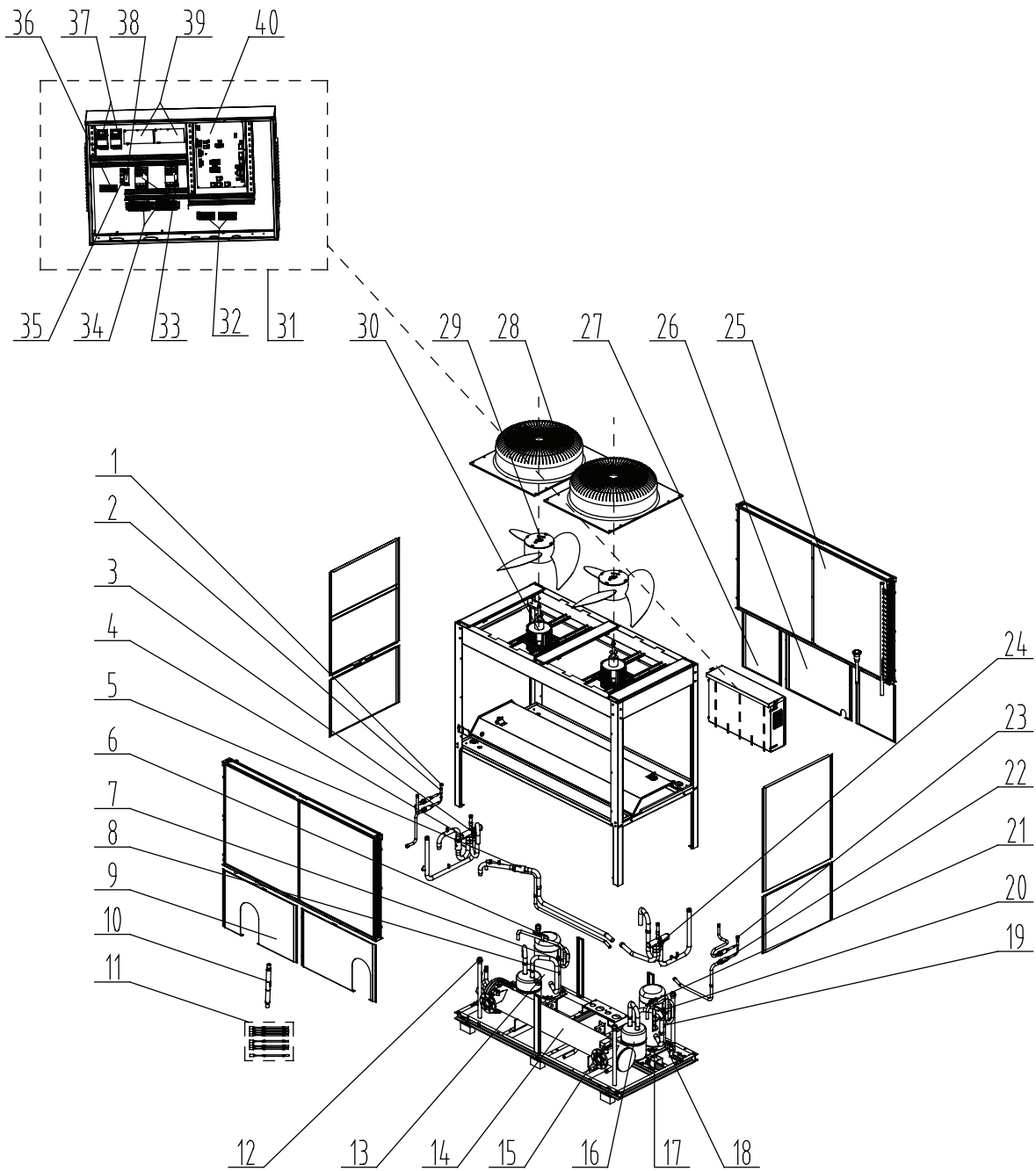

Parts List: LSQWRF80M/NaD-M for EL01500520

No.	Name of part	Part code
1	Electric Expand Valve Fitting	4304413213
2	Electronic Expansion Valve	07331139
3	Magnet Coil	4300040064
4	4-way Valve	43000412
5	Filter	07414118
6	Pressure Protect Switch	4602001570
7	Pressure Protect Switch	4602001582
8	Pressure Protect Switch	4602001579
9	Rear Panel	01541100001P
10	One Way Valve	0733420001
11	Sensor Sub-assy	39008000004G
12	pipe connector	06128301
13	Compressor	00201100004
14	Dry Evaporator	01058800057
15	Steam current Switch	45028209
16	Gas-liquid Separator	07421111
17	Compressor Gasket	02118049
18	Electrical Heater	76515211
19	Pressure Protect Switch	4602001583
20	Pressure Protect Switch	4602001581
21	Pressure Protect Switch	4602001569
22	Strainer	07210037
23	Electric Expand Valve Fitting	4304413214
24	Magnet Coil	4300040048
25	Condenser Assy	01121100020
26	Front Panel	01541100003P
27	Front Panel	01541100002P
28	Streamlined Dome	22265801
29	Centrifugal Fan	10355801
30	Fan Motor	15701100003
31	Electric Box Assy	01391100061
32	Terminal Board	42018452
33	AC Contactor	44010229
34	Terminal Board	42011135
35	Single-phase Air Switch	45020203
36	Terminal Board	420102471
37	AC Contactor	44010240
38	Phase Reverse Protector	32214101
39	Over Current Protector	46028000010
40	Main Board	30222000002



(3). Model: LSQWRF130M/NaD-M

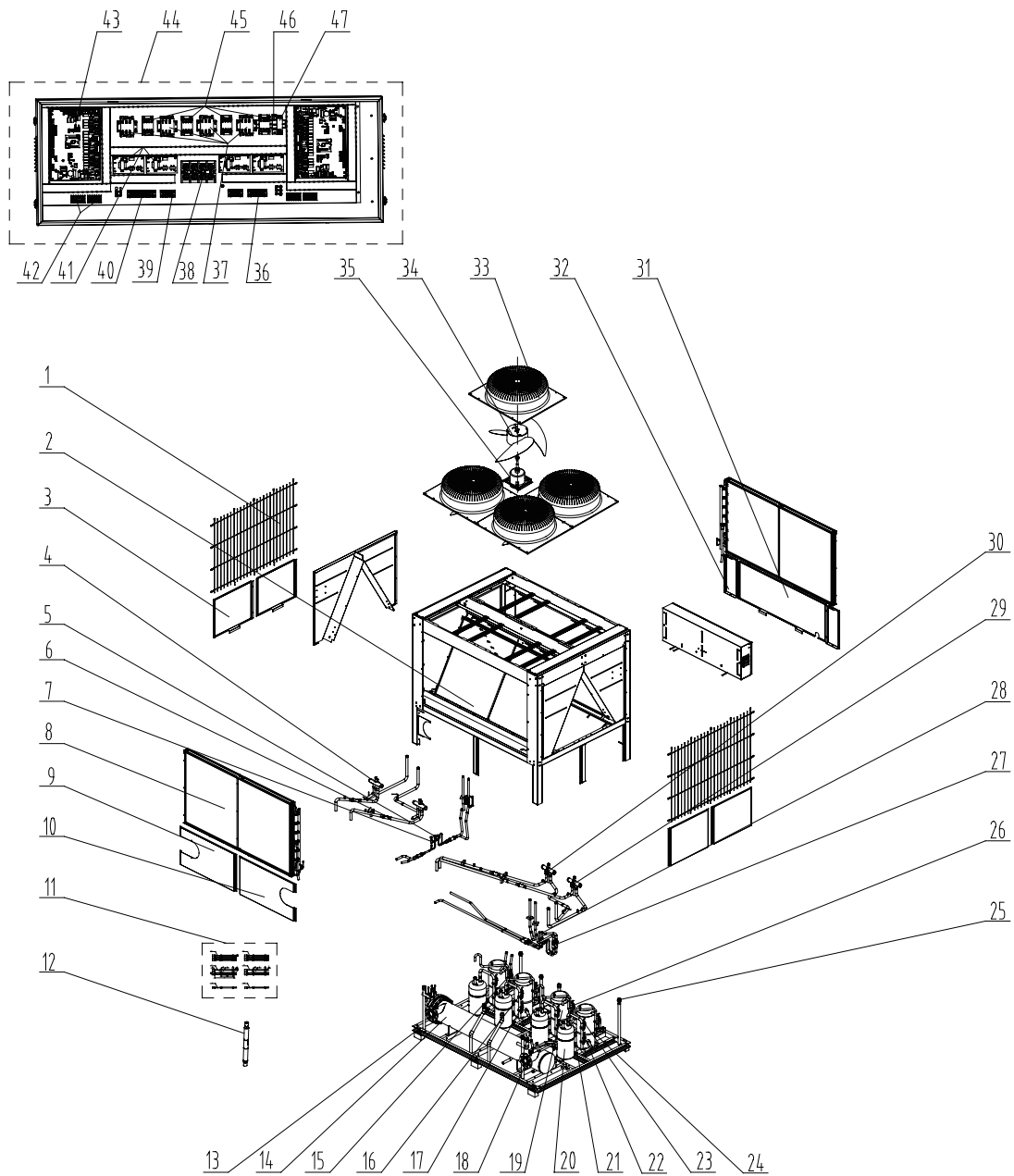

Parts List: LSQWRF130M/NaD-M for EL01500510

No.	Name of part	Part code
1	Rear Grill	01571100001
2	Condenser Assy 1	0112110001101
3	Lower panel	01541100005P
4	4-way Valve	43000339
5	Electric Expand Valve Fitting	4304413214
6	Filter	07218603
7	Electronic Expansion Valve	07331139
8	Condenser Assy 2	0112110001201
9	Lower panel	01541100006P
10	Lower panel	01541100007P
11	Sensor Sub-assy	39008000003G
12	One Way Valve	07332224
13	Chassis Sub-assy	01191100004P
14	Dry Evaporator	01058800013
15	Pressure Protect Switch	4602001570
16	Pressure Protect Switch	4602001584
17	Pressure Protect Switch	4602001585
18	Steam current Switch	45028209
19	Compressor	00201100002
20	Gas-liquid Separator	07424148
21	Compressor Gasket	02118049
22	Pressure Protect Switch	4602001582
23	Pressure Protect Switch	4602001579
24	Electrical Heater	76515211
25	pipe connector	06128301
26	Pressure Protect Switch	4602001547
27	Strainer	07210037
28	Electric Expand Valve Fitting	4304413213
29	Magnet Coil	4300040048
30	Magnet Coil	4300040049
31	Lower panel	01541100004P
32	Side Plate	01311100006P
33	Streamlined Dome	22265801
34	Centrifugal Fan	10355801
35	Fan Motor	15701100001
36	Terminal Board	420111251
37	AC Contactor	44010235
38	Terminal Board	42010247
39	Terminal Board	42010254
40	Terminal Board	42011135
41	Over Current Protector	46028000011
42	Terminal Board	42018452
43	Main Board	30222000002
44	Electric Box Assy	01391100047
45	AC Contactor	44010229
46	Single-phase Air Switch	45020203
47	Phase Reverse Protector	32214101

(4). Model: LSQWRF160M/NaD-M

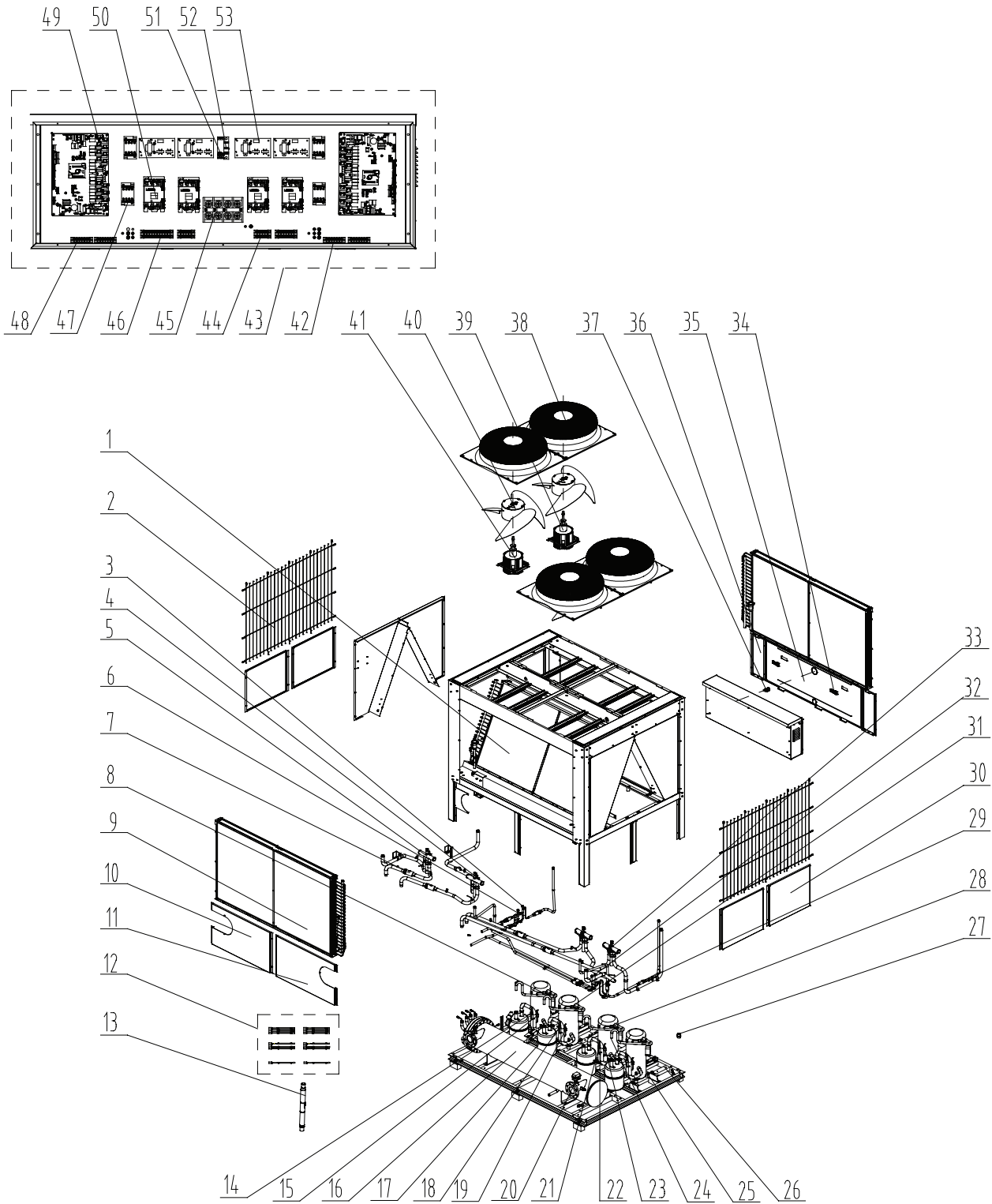

Parts List: LSQWRF130M/NaD-M for EL01500530

No.	Name of part	Part code
1	Condenser assy 2	0112110002501
2	Rear Grill	01571100001
3	Electric Expand Valve Fitting	4304413213
4	Magnet Coil	4300040049
5	4-Way Valve	43000412
6	Electronic Expansion Valve	07331139
7	Filter	07414118
8	Pressure Protect Switch	4602001570
9	Condenser assy 1	0112110002601
10	Lower Panel 3	01541100082P
11	Lower Panel 4	01541100047P
12	Sensor Sub-assy	39008000046G
13	One Way Valve	0733420001
14	Pressure Protect Switch	4602001579
15	Pressure Protect Switch	4602001582
16	Dry Evaporator	01058800064
17	Gas-liquid Separator	07421111
18	Pressure Protect Switch	4602001591
19	Pressure Protect Switch	4602001590
20	Steam current Switch	45028209
21	Pressure Protect Switch	4602001583
22	Electrical Heater	76515211
23	Pressure Protect Switch	4602001581
24	Compressor	00201100004
25	Compressor Gasket	02118049
26	Chassis Sub-assy	01191100011P
27	pipe connector	06128301
28	Pressure Protect Switch	4602001569
29	Strainer	07210037
30	Lower Panel	01541100067P
31	Pressure Protect Switch	4602001589
32	Electric Expand Valve Fitting	4304413214
33	Magnet Coil	4300040048
34	Handle	26235253
35	Lower Panel 1	01541100053P
36	Side Plate	01311100006P
37	Scram switch	45010024
38	Streamlined Dome	22265801
39	Fan Motor	15701100003
40	Centrifugal Fan	10355801
41	Fan Motor	1570110000301
42	Terminal Board	420111251
43	Electric Cabinet Assy	01391100069
44	Terminal Board	42010254
45	Terminal Board	42010247
46	Terminal Board	42011135
47	AC Contactor	44010229
48	Terminal Board	42018452
49	Main Board	30222000002
50	AC Contactor	44010240
51	Phase Reverse Protector	32214101
52	Single-phase Air Switch	45020203
53	Over Current Protector	46028000008



JF00301781

GREE ELECTRIC APPLIANCES, INC. OF ZHUHAI

Add: West Jinji Rd, Qianshan, Zhuhai, Guangdong, China, 519070

Tel: (+86-756) 8522218 Fax: (+86-756) 8669426

E-mail: gree@gree.com.cn www.gree.com

For continuous improvement in the products, Gree reserves the right to modify the product specification and appearance in this manual without notice and without incurring any obligations.