

# MULTI

## МУЛЬТИ СПЛИТ-СИСТЕМЫ



**Модельный ряд** 58

**Наружные блоки**

-Multi F 62

-Multi FDX 66

**Внутренние блоки**

-Настенный тип 74

-Кассетный тип 76

-Канальный тип 77

-Напольно-потолочный тип 78

-Консольный тип 79

**Блоки распределители  
и разветвители**















80

**Таблицы комбинаций**

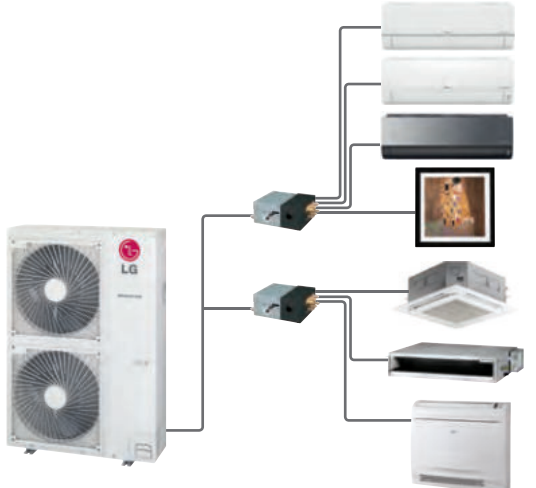



































82

# 2019 Модельный ряд

## Наружные блоки

Тип кВт (охл/нагр)	Multi F	Макс. кол-во вн. блок	Эл. питание	Пример комбинаций
4,1 / 4,7	 MU2M15	2	1Ø	
4,7 / 5,3	 MU2M17	2	1Ø	
5,3 / 6,3	 MU3M19	3	1Ø	
6,2 / 7,0	 MU3M21	3	1Ø	
7,0 / 8,4	 MU4M25	4	1Ø	
7,9 / 9,1	 MU4M27	4	1Ø	
8,8 / 10,1	 MU5M30	5	1Ø	
11,2 / 12,5	 MU5M40	5	1Ø	
Тип кВт (охл/нагр)	Multi FDX	Макс. кол-во вн. блок	Эл. питание	Пример комбинаций
11,2 / 12,5	 FM40AH	7	1Ø	
12,1 / 12,5	 FM41AH	7	3Ø	
14,0 / 16,0	 FM48AH  FM49AH	8	1Ø 3Ø	
15,5 / 17,4	 FM56AH  FM57AH	9	1Ø 3Ø	

## Внутренние блоки

Тип		кБте	5	7	9	12	15	18	24
		кВт	1,5	2,1	2,6	3,5	4,2	5,3	6,7
Настенный тип	Standard Plus	 PM05SP	 PM07SP	 PM09SP	 PM12SP	 PM15SP	 PM18SP	 PM24SP	
	Deluxe		 DM07RP	 DM09RP	 DM12RP		 DM18RP	 DM24RP	
	ΔRT COOL Mirror		 AM07BP	 AM09BP	 AM12BP		 AM18BP	 AM24BP	
	ΔRT COOL Gallery			 MA09AH1	 MA12AH1				
Кассетный тип	Однопоточные			 MT09AH	 MT11AH				
	Четырехпоточные	 MT06AH	 MT08AH	 CT09	 CT12		 CT18	 CT24	
Канальный тип	Средне/высоко напорные						 CM18	 CM24	
	Низконапорные			 CB09L	 CB12L		 CB18L	 CB24L	
Напольно- потолочный тип				 CV09	 CV12				
Консольный тип				 CQ09	 CQ12		 CQ18		

## Отличие Multi F и Multi FDX

В модельном ряду мульти сплит-систем LG Electronics существует два принципиально разных вида оборудования – это Multi F и Multi FDX. Главное отличие между ними заключается в том, что к Multi F внутренние блоки подключаются напрямую к наружному блоку, а в Multi FDX подключение к наружному блоку происходит через специальные блоки распределители, что позволяет расширить максимальное количество внутренних блоков до 9 и увеличить суммарную длину трассы до 145 м. Важным следует отметить, что в отличие от аналогичных Multi FDX, представленных на рынке кондиционирования, отвод конденсата от блоков-распределителей PMBD осуществлять не нужно, что, во-первых, упрощает процедуру монтажа, во-вторых, удешевляет ее.

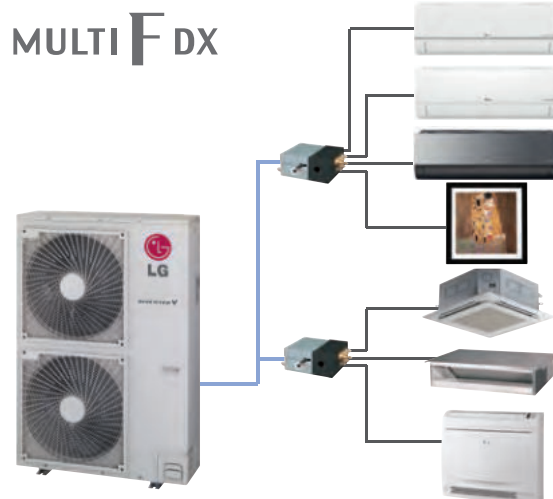

## Различные комбинации системы

Пользователь может выбрать из 10-ти различных типов внутренних блоков, которые подходят под особенности любого интерьера



14 Наружных блоков

более  
**2000**  
Комбинаций

38 Внутренних блока

## Увеличенная длина трубопроводов

Системы Multi FDX имеют суммарную максимальную длину трубопроводов до 145 м и перепад высот до 30м, что обеспечивает расширенные возможности для монтажа системы, и области ее применения

### Multi F

(м)		MU2M15 MU2M17	MU3M19 MU3M21	MU4M25 MU4M27	MU5M30	MU5M40
Суммарная длина трубопроводов		30	50	70	75	85
Максимальная длина		20	25	25	25	25
Перепад высот	Внутренний - наружный	15	15	15	15	15
	Внутренний - внутренний	7.5	7.5	7.5	7.5	7.5

### Multi FDX

(м)		FM40AH	FM41AH	FM48AH FM49AH	FM56AH FM57AH
Суммарная длина трубопроводов		100	125	135	145
Длина от наружного блока до БР* блока		50	55	55	55
Суммарная длина ответвлений		50	70	80	90
Длина от БР* блока до внутреннего блока		15	15	15	15
Перепад высот	Внутренний - наружный	30	30	30	30
	Внутренний - внутренний	15	15	15	15

\* Блок распределитель

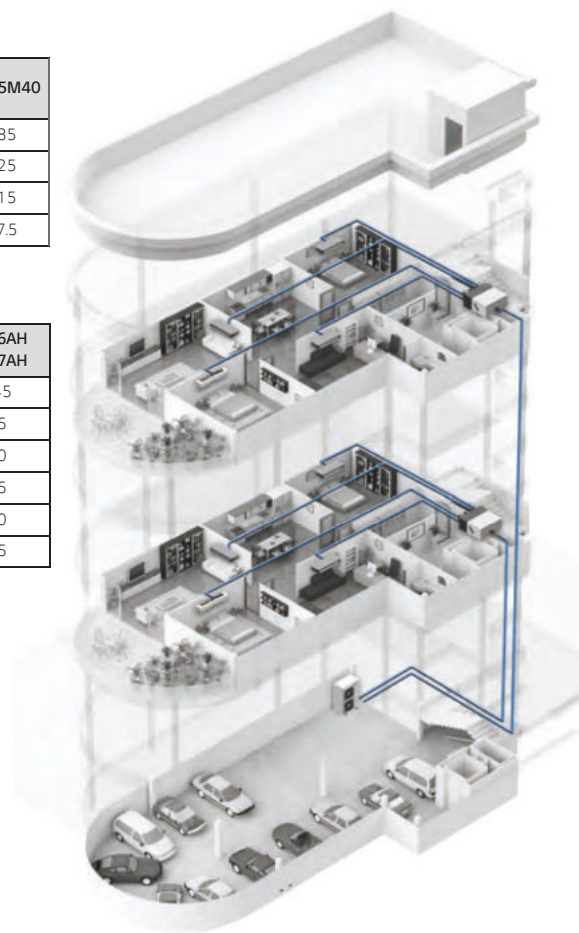

# MU2M15 | MU2M17

## MULTI F Inverter

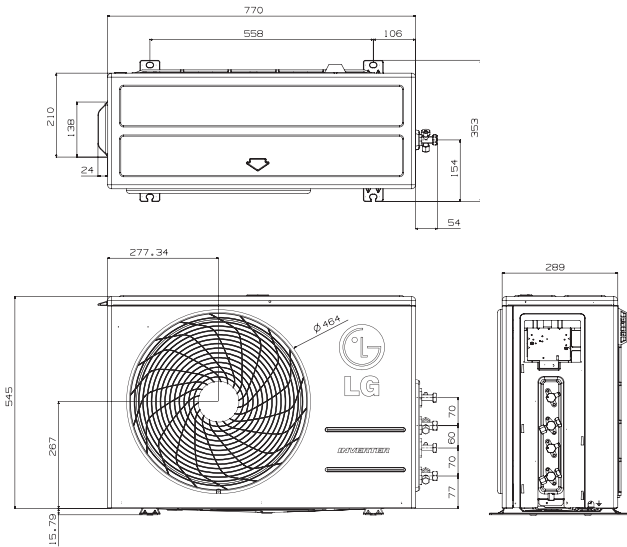

Сделано в Корее

Наружный блок				MU2M15 UL4R0	MU2M17 UL4R0
Макс. количество подключаемых внутренних блоков				2	2
Макс. индекс производительности внутренних блоков				21	24
Производительность	Охлаждение	Номинал	кВт	0.9/4.1/4.7	0.9/4.7/5.4
	Нагрев	Номинал	кВт	1.0/4.7/5.4	1.0/5.3/5.7
При низкой температуре	Нагрев -7°C	Номинал	кВт	3.3	3.3
	Охлаждение	Номинал	кВт	0.2/1.0/1.4	0.2/1.3/1.7
Потребляемая мощность	Нагрев	Номинал	кВт	0.2/1.1/1.5	0.2/1.2/1.7
	Охлаждение	Мин/Ном/Макс	А	1.1/4.6/6.4	1.1/5.6/7.9
Рабочий ток	Нагрев	Мин/Ном/Макс	А	1.1/4.9/6.7	1.1/5.5/7.6
	Охлаждение	EER		4,15	3,75
Коэффициент энергоэффективности	Нагрев	COP		4,40	4,25
	Охлаждение/Нагрев	EER/COP		A/A	A/A
Класс энергоэффективности	Охлаждение	SEER		7,6	7,5
	Нагрев	SCOP		4,2	4,2
Класс Сезонной энергоэффективности				A++/A+	A++/A+
Расход воздуха		Номинал	м <sup>3</sup> /мин	28,20	28,20
Уровень звукового давления	Охлаждение	Номинал	дБ(А)	48	48
	Нагрев	Номинал	дБ(А)	51	51
Уровень шума	Охлаждение	Макс	дБ(А)	61	63
Габаритные размеры			ШxВxГ	770 x 545 x 288	770 x 545 x 288
Масса нетто			кг	37	37
Хладагент	Тип			R410A	R410A
	Заводская заправка		г	1400	1400
	Макс. длина трассы при заводской заправке		м	20	20
	Дополнительная заправка		г/м	20	20
Температурный диапазон	Охлаждение	Мин-Макс	°С СТ	-10-48	-10-48
	Нагрев	Мин-Макс	°С ВТ	-18-18	-18-18
Электропитание			В/Гц	1/220-240/50	1/220-240/50
Питающий кабель (с заземлением)			Кол-во x мм <sup>2</sup>	3x2,5	3x2,5
Межблочный кабель (с заземлением)			Кол-во x мм <sup>2</sup>	4x0,75	4x0,75
Автоматический выключатель (УЗО)			А	16	16
Максимальная длина трубопроводов	Общая длина трубопроводов		м	30	30
	До каждого внутреннего блока		м	20	20
Макс. перепад высот	Внутр - Наружн		м	15	15
	Внутр - Внутр		м	7,5	7,5
Диаметры трубопроводов	Жидкость	мм (дюймы) x кол-во		Ø6.35 (1/4)x2	Ø6.35 (1/4)x2
	Газ	мм (дюймы) x кол-во		Ø9.52 (3/8)x2	Ø9.52 (3/8)x2

# MU3M19 | MU3M21

## MULTI F Inverter

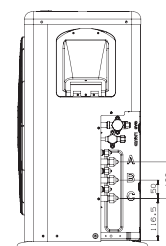
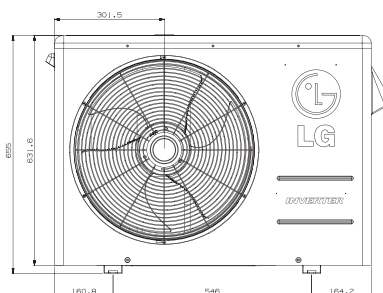
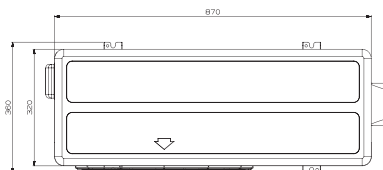

Сделано в Корее

Наружный блок				MU3M19 UE4R0	MU3M21 UE4R0
Макс. количество подключаемых внутренних блоков				3	3
Макс. индекс производительности внутренних блоков				30	33
Производительность	Охлаждение	Номинал	кВт	1.1/5.3/6.3	1.1/6.2/7.3
	Нагрев	Номинал	кВт	1.2/6.3/7.3	1.2/7.0/7.8
При низкой температуре	Нагрев -7°C	Макс	кВт	4,4	4,9
	Охлаждение	Номинал	кВт	0.3/1.3/1.8	0.3/1.6/2.2
Потребляемая мощность	Нагрев	Номинал	кВт	0.3/1.5/2.1	0.3/1.7/2.4
	Охлаждение	Мин/Ном/Макс	А	1.2/5.8/8.7	1.2/7.2/10.0
Рабочий ток	Нагрев	Мин/Ном/Макс	А	1.2/6.8/9.7	1.2/7.7/11.0
	Охлаждение	EER		4,20	4,00
Коэффициент энергоэффективности	Нагрев	COP		4,30	4,20
	Охлаждение/Нагрев	EER/COP		A/A	A/A
Коэффициент Сезонной энергоэффективности	Охлаждение	SEER		7,6	7,3
	Нагрев	SCOP		4,21	4,21
Класс Сезонной энергоэффективности				A++/A+	A++/A+
Расход воздуха		Номинал	м <sup>3</sup> /мин	50	50
Уровень звукового давления	Охлаждение	Номинал	дБ(А)	49	50
	Нагрев	Номинал	дБ(А)	54	54
Уровень шума	Охлаждение	Макс	дБ(А)	63	64
Габаритные размеры	ШхВхГ		мм	870 x 655 x 320	870 x 655 x 320
Масса нетто			кг	45	45
Хладагент	Тип			R410A	R410A
	Заводская заправка		г	1700	1700
	Макс. длина трассы при заводской заправке		м	20	20
	Дополнительная заправка		г/м	20	20
Температурный диапазон	Охлаждение	Мин-Макс	°C СТ	-10-48	-10-48
	Нагрев	Мин-Макс	°C ВТ	-18-18	-18-18
Электропитание				φ/В/Гц	1/220-240/50
Питающий кабель (с заземлением)				Кол-во x мм <sup>2</sup>	3x2,5
Межблочный кабель (с заземлением)				Кол-во x мм <sup>2</sup>	4x0,75
Автоматический выключатель (УЗО)				А	20
Максимальная длина трубопроводов	Общая длина трассы		м	50	50
	До каждого внутреннего блока		м	25	25
Макс. перепад высот	Внутр - Наружн	Макс	м	15	15
	Внутр - Внутр	Макс	м	7,5	7,5
Диаметры трубопроводов	Жидкость		мм (дюймы) x кол-во	Ø6.35 (1/4)x3	Ø6.35 (1/4)x3
	Газ		мм (дюймы) x кол-во	Ø9.52 (3/8)x3	Ø9.52 (3/8)x3



# MU4M25 | MU4M27 | MU5M30

## MULTI F Inverter

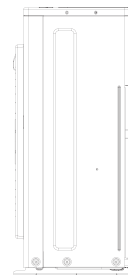
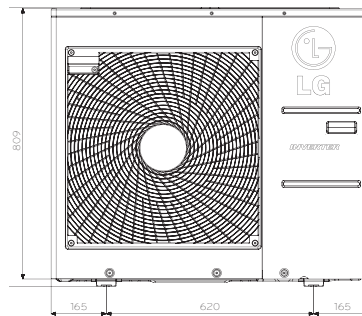
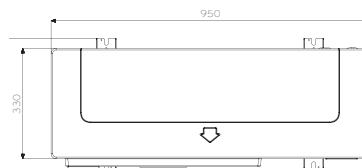

Сделано в Корее

Наружный блок				MU4M25 U44R0	MU4M27 U44R0	MU5M30 U44R0
Макс. количество подключаемых внутренних блоков				4	4	5
Макс. индекс производительности внутренних блоков				39	41	48
Производительность	Охлаждение	Номинал	кВт	1.3/7.0/8.5	1.3/7.9/9.5	1.3/8.8/10.6
	Нагрев	Номинал	кВт	1.5/8.4/9.4	1.5/9.1/10.6	1.5/10.1/12.1
При низкой температуре	Нагрев -7°C	Номинал	кВт	5.9	6.4	7.1
Потребляемая мощность	Охлаждение	Номинал	кВт	0.4/1.7/2.7	0.4/2.0/3.2	0.4/2.3/3.6
	Нагрев	Номинал	кВт	0.6/1.9/3.0	0.6/2.1/3.5	0.6/2.3/3.7
Рабочий ток	Охлаждение	Мин/Ном/Макс	A	1.9/7.4/12.1	1.9/8.9/14.4	1.9/10.2/16.2
	Нагрев	Мин/Ном/Макс	A	2.8/8.6/13.4	2.8/9.6/15.7	2.8/10.4/16.8
Коэффициент энергоэффективности	Охлаждение	EER		4,30	4,00	3,90
	Нагрев	COP		4,40	4,30	4,41
Класс энергоэффективности	Охлаждение/Нагрев	EER/COP		A+/A	A/A	A/A
Коэффициент Сезонной энергоэффективности	Охлаждение	SEER		7,3	7,2	7,0
	Нагрев	SCOP		4,0	4,0	4,0
Класс Сезонной энергоэффективности	Охлаждение/Нагрев			A++/A+	A++/A+	A++/A+
Расход воздуха		Номинал	м <sup>3</sup> /мин	60	60	60
Уровень звукового давления	Охлаждение	Номинал	дБ(A)	49	50	50
	Нагрев	Номинал	дБ(A)	53	54	54
Уровень шума	Охлаждение	Макс	дБ(A)	64	65	66
Габаритные размеры	ШxВxГ		мм	950 x 834 x 330	950 x 834 x 330	950 x 834 x 330
Масса нетто			кг	61	61	61
Хладагент	Тип			R410A	R410A	R410A
	Заводская заправка		г	2800	2800	3200
	Макс. длина трассы при заводской заправке		м	20	20	20
	Дополнительная заправка		г/м	20	20	20
Температурный диапазон	Охлаждение	Мин-Макс	°C СТ	-10-48	-10-48	-10-48
	Нагрев	Мин-Макс	°C ВТ	-18-18	-18-18	-18-18
Электропитание			ØВ/Гц	1/220-240/50	1/220-240/50	1/220-240/50
Питающий кабель (с заземлением)			Кол-во x мм <sup>2</sup>	3x2,5	3x2,5	3x2,5
Межблочный кабель (с заземлением)			Кол-во x мм <sup>2</sup>	4x0,75	4x0,75	4x0,75
Автоматический выключатель (УЗО)			A	25	25	25
Максимальная длина трубопроводов	Общая длина трассы		м	70	70	75
	До каждого внутреннего блока		м	25	25	25
Макс. перепад высот	Внутр - Наружн	Макс	м	15	15	15
	Внутр - Внутр	Макс	м	7,5	7,5	7,5
Диаметры трубопроводов	Жидкость		мм (дюймы) x кол-во	Ø6.35 (1/4)x4	Ø6.35 (1/4)x4	Ø6.35 (1/4)x5
	Газ		мм (дюймы) x кол-во	Ø9.52 (3/8)x4	Ø9.52 (3/8)x4	Ø9.52 (3/8)x5

# MU5M40

## MULTI F Inverter

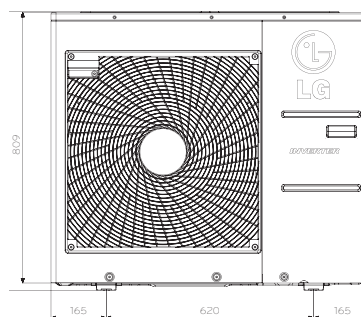
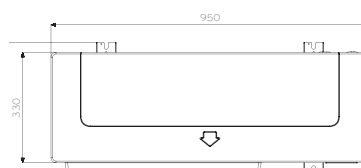

Сделано в Корее

Наружный блок				MU5M40 UO3R0
Макс. количество подключаемых внутренних блоков				5
Макс. индекс производительности внутренних блоков				52
Производительность	Охлаждение	Номинал	кВт	11.2 (1.8 - 14.7)
	Нагрев	Номинал	кВт	12.5 (2.0 - 15.5)
Потребляемая мощность	Охлаждение	Номинал	кВт	2.8 (0.8 - 5.0)
	Нагрев	Номинал	кВт	2.9 (0.8 - 5.2)
Коэффициент энергоэффективности	Охлаждение	EER		4
	Нагрев	COP		4,3
Коэффициент Сезонной энергоэффективности	Охлаждение	SEER		7,1
	Нагрев	SCOP		4
Класс Сезонной энергоэффективности				A++ / A+
Электропитание			В / ø / Гц	220-240/ 1/ 50
Питающий кабель (с заземлением)			Кол-во x мм <sup>2</sup>	3 x 3.5
Межблочный кабель (с заземлением)			Кол-во x мм <sup>2</sup>	4 x 0.75
Автоматический выключатель (УЗО)			А	30
Габаритные размеры			ШxВxГ	950 x 834 x 330
Вес нетто			кг	72
Расход воздуха			Номинал	м <sup>3</sup> /мин
Уровень звукового давления	Охлаждение	Номинал	дБ(А)	53
	Нагрев	Номинал	дБ(А)	55
Уровень шума			Охлаждение	Макс
				дБ(А)
				67
Компрессор				Спиральный
Хладагент	Тип			R410A
	Заводская заправка		г	3 500
	Макс. длина трассы при заводской заправке		м	20
	Дополнительная заправка		г/м	20
Диаметры трубопроводов	Жидкость		мм (дюймы) x кол-во	ø6.35 (1/4) x 5
	Газ		мм (дюймы) x кол-во	ø9.52 (3/8) x 5
Максимальная длина трубопроводов	Общая длина трассы		м	85
	До каждого внутреннего блока		м	25
Макс. перепад высот	Внутр - Наружн	Макс	м	15
	Внутр - Внутр	Макс	м	7,5
Температурный диапазон	Охлаждение	Мин-Макс	°С СТ	-10°С - 48°С
	Нагрев	Мин-Макс	°С ВТ	-18°С - 18°С

# FM40AH

## MULTI F Inverter

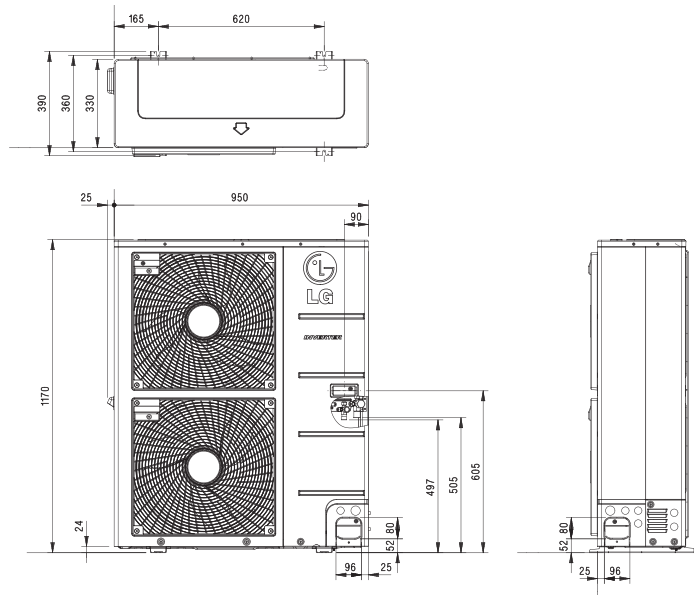
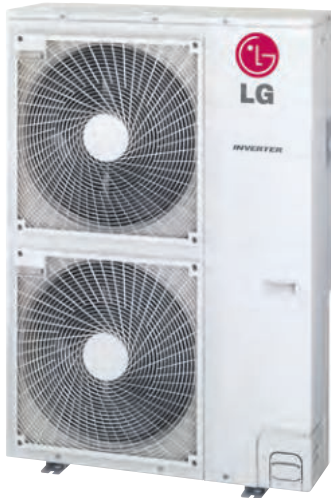

Сделано в Корее

Наружный блок				FM40AH U03R0
Макс. количество подключаемых внутренних блоков				7
Макс. индекс производительности внутренних блоков				16 - 52
Производительность	Охлаждение	Номинал	кВт	<b>11.2 (2.8 - 13.5)</b>
	Нагрев	Номинал	кВт	<b>12.5 (3.1 - 15.0)</b>
Потребляемая мощность	Охлаждение	Номинал	кВт	2.7 (0.8 - 4.2)
	Нагрев	Номинал	кВт	2.8 (0.8 - 4.5)
Коэффициент энергоэффективности	Охлаждение	EER		4,8
	Нагрев	COP		4,7
Коэффициент Сезонной энергоэффективности	Охлаждение	SEER		7,3
	Нагрев	SCOP		4,2
Класс Сезонной энергоэффективности	Охлаждение/Нагрев			A++ / A+
Электропитание				V / ø / Гц 220-240/ 1/ 50
Питающий кабель (с заземлением)				Кол-во жил x мм <sup>2</sup> (экр.) 3 x 4.0
Межблочный кабель (с заземлением)	От наружного блока до блока распределителя		Кол-во жил x мм <sup>2</sup> (экр.)	4 x 1.25
	От блока распределителя до внутреннего блока		Кол-во жил x мм <sup>2</sup> (экр.)	4 x 0.75
Автоматический выключатель (УЗО)				A 40
Габаритные размеры	ШxВxГ			мм 950 x 1,380 x 330
Вес нетто				кг 88
Расход воздуха		Номинал	м <sup>3</sup> /мин	120
Уровень звукового давления	Охлаждение	Номинал	дБ(А)	53
	Нагрев	Номинал	дБ(А)	55
Уровень шума	Охлаждение	Макс	дБ(А)	66
Компрессор	Тип			Спиральный
Хладагент	Тип			R410A
	Заводская заправка			г 4 200
Диаметры трубопроводов	Жидкость		мм (дюймы) x кол-во	Ø9.52 (3/8)
	Газ		мм (дюймы) x кол-во	Ø19.05 (3/4)
Максимальная длина трубопроводов	Общая длина трассы			м 100
	До каждого внутреннего блока			м 50
	Суммарная длина ответвлений			м 50
	От блока распределителя до внутрен. блока			м 15
Макс. перепад высот	Внутр - Наружн	Макс	м	30
	Внутр - Внутр	Макс	м	15
Температурный диапазон	Охлаждение	Мин-Макс	°С СТ	-10 - 48
	Нагрев	Мин-Макс	°С ВТ	-18 - 18

# FM48AH | FM56AH

## MULTI F Inverter

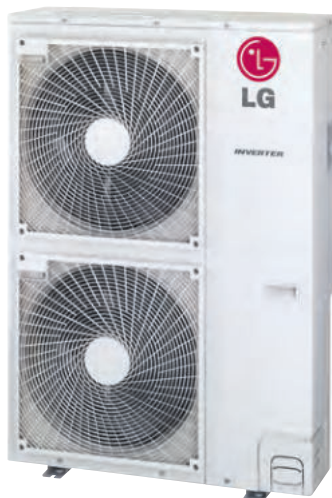

Сделано в Корее

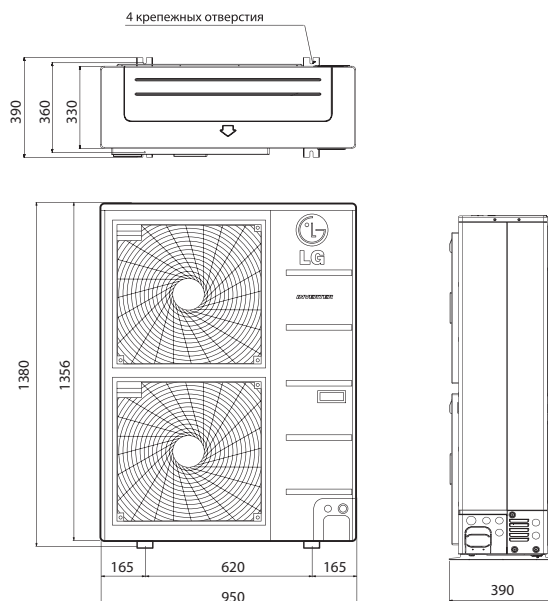

Наружный блок				FM48AH U33R0	FM56AH U33R0			
Макс. количество подключаемых внутренних блоков				8	9			
Макс. индекс производительности внутренних блоков				19 - 63	23 - 73			
Производительность	Охлаждение	Номинал	кВт	<b>14.0 (2.8 - 17.0)</b>	<b>15.5 (2.8 - 18.5)</b>			
	Нагрев	Номинал	кВт	<b>16.0 (3.2 - 17.3)</b>	<b>17.4 (3.2 - 18.8)</b>			
Потребляемая мощность	Охлаждение	Номинал	кВт	3.3 (1.0 - 5.4)	4.0 (1.0 - 5.9)			
	Нагрев	Номинал	кВт	3.8 (1.5 - 5.8)	4.4 (1.5 - 6.5)			
Коэффициент энергоэффективности	Охлаждение	EER		4,2	3,9			
	Нагрев	COP		4,2	4			
Коэффициент Сезонной энергоэффективности	Охлаждение	SEER		7,1	6,7			
	Нагрев	SCOP		4,2	4,2			
Класс Сезонной энергоэффективности				А++ / А+	А++ / А+			
Электропитание				В / ф / Гц	220-240/ 1/ 50			
Питающий кабель (с заземлением)				В / ф / Гц	220-240/ 1/ 50			
			Кол-во жил x мм <sup>2</sup> (экран.)	3 x 4.0	3 x 4.0			
Межблочный кабель (с заземлением)			От наружного блока до блока распределителя	Кол-во жил x мм <sup>2</sup> (экран.)	4 x 1.25	4 x 1.25		
			От блока распределителя до внутреннего блока	Кол-во жил x мм <sup>2</sup> (экран.)	4 x 0.75	4 x 0.75		
Автоматический выключатель (УЗО)				А	40	40		
Габаритные размеры				ШxВxГ	мм	950 x 1,380 x 330	950 x 1,380 x 330	
Вес нетто				кг	88	88		
Расход воздуха				Номинал	м <sup>3</sup> /мин	120	120	
Уровень звукового давления	Охлаждение	Номинал	дБ(А)	53	53			
	Нагрев	Номинал	дБ(А)	55	55			
Уровень шума				Охлаждение	Макс	дБ(А)	67	68
Компрессор				Тип	Спиральный	Спиральный		
Хладагент				Тип	R410A	R410A		
				Заводская заправка	г	4 200	4 200	
Диаметры трубопроводов				Жидкость	мм (дюймы) x кол-во	Ø9.52 (3/8)	Ø9.52 (3/8)	
				Газ	мм (дюймы) x кол-во	Ø19.05 (3/4)	Ø19.05 (3/4)	
Максимальная длина трубопроводов				Общая длина трассы	м	135	145	
				До каждого внутреннего блока	м	55	55	
				Суммарная длина ответвлений	м	80	90	
				От блока распределителя до внутрен. блока	м	15	15	
Макс. перепад высот				Внутр - Наружн	Макс	м	30	30
				Внутр - Внутр	Макс	м	15	15
Температурный диапазон				Охлаждение	Мин-Макс	°С СТ	-10 ~ 48	-10 ~ 48
				Нагрев	Мин-Макс	°С ВТ	-18 ~ 18	-18 ~ 18

# FM41AH

## MULTI F Inverter

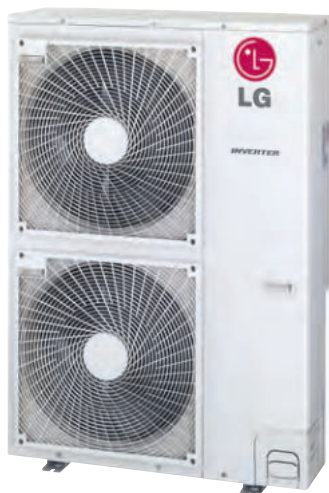

Сделано в Корее

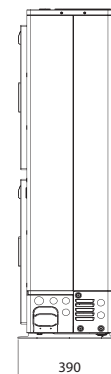
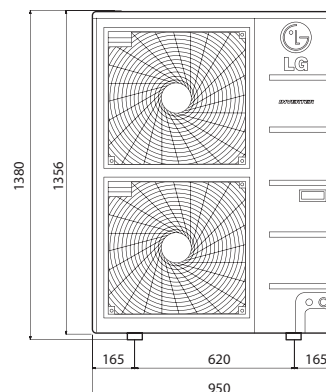

Наружный блок				FM41AH U33R0
Макс. количество подключаемых внутренних блоков				7
Макс. индекс производительности внутренних блоков				16 - 54
Производительность	Охлаждение	Номинал	кВт	<b>12.3 (2.8 - 14.7)</b>
	Нагрев	Номинал	кВт	<b>13.5 (3.2 - 15.2)</b>
Потребляемая мощность	Охлаждение	Номинал	кВт	2.6 (1.0 - 4.4)
	Нагрев	Номинал	кВт	2.9 (1.5 - 4.8)
Коэффициент энергоэффективности	Охлаждение	EER		4,8
	Нагрев	COP		4,7
Коэффициент Сезонной энергоэффективности	Охлаждение	SEER		7,3
	Нагрев	SCOP		4,2
Класс Сезонной энергоэффективности	Охлаждение/Нагрев			A++ / A+
Электропитание	В / ø / Гц			3 / 380-415 / 50
Питающий кабель (с заземлением)	Кол-во жил x мм <sup>2</sup> (экран.)			5 x 2.5
Межблочный кабель (с заземлением)	От наружного блока до блока распределителя			4 x 1.25
	От блока распределителя до внутреннего блока			4 x 0.75
Автоматический выключатель (УЗО)	А			20
Габаритные размеры	ШxВxГ	мм		950 x 1,380 x 330
Вес нетто	кг			88
Расход воздуха		Номинал	м <sup>3</sup> /мин	120
Уровень звукового давления	Охлаждение	Номинал	дБ(А)	53
	Нагрев	Номинал	дБ(А)	55
Уровень шума	Охлаждение	Макс	дБ(А)	66
Компрессор	Тип			Спиральный
Хладагент	Тип			R410A
	Заводская заправка			г
Диаметры трубопроводов	Жидкость			мм (дюймы) x кол-во
	Газ			мм (дюймы) x кол-во
Максимальная длина трубопроводов	Общая длина трассы			м
	До каждого внутреннего блока			м
	Суммарная длина ответвлений			м
	От блока распределителя до внутрен. блока			м
Макс. перепад высот	Внутр - Наружн	Макс	м	30
	Внутр - Внутр	Макс	м	15
Температурный диапазон	Охлаждение	Мин-Макс	°C СТ	-10 - 48
	Нагрев	Мин-Макс	°C ВТ	-18 - 18

# FM49AH | FM57AH

## MULTI F Inverter

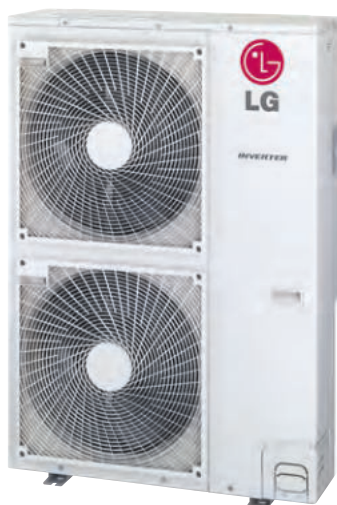

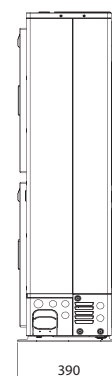
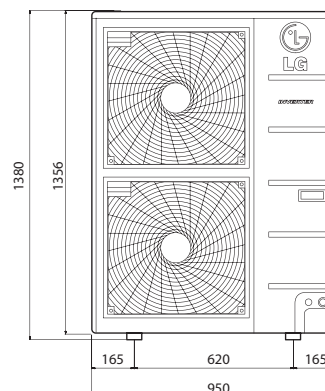

Сделано в Корее



Наружный блок				FM49AH U33R0	FM57AH U33R0		
Макс. количество подключаемых внутренних блоков				8	9		
Макс. индекс производительности внутренних блоков				19 - 63	23 - 73		
Производительность	Охлаждение	Номинал	кВт	<b>14.0 (2.8 - 17.0)</b>	<b>15.5 (2.8 - 18.5)</b>		
	Нагрев	Номинал	кВт	<b>16.0 (3.2 - 17.3)</b>	<b>17.4 (3.2 - 18.8)</b>		
Потребляемая мощность	Охлаждение	Номинал	кВт	3.3 (1.0 - 5.4)	4.0 (1.0 - 5.9)		
	Нагрев	Номинал	кВт	3.8 (1.5 - 5.8)	4.4 (1.5 - 6.5)		
Коэффициент энергоэффективности	Охлаждение	EER		4,2	3,9		
	Нагрев	COP		4,2	4		
Коэффициент Сезонной энергоэффективности	Охлаждение	SEER		7,1	6,7		
	Нагрев	SCOP		4,2	4,2		
Класс Сезонной энергоэффективности				A++ / A+	A++ / A+		
Электропитание			В / ø / Гц	3 / 380-415 / 50	3 / 380-415 / 50		
Питающий кабель (с заземлением)			Кол-во жил x мм <sup>2</sup> (экран.)	5 x 2.5	5 x 2.5		
Межблочный кабель (с заземлением)	От наружного блока до блока распределителя		Кол-во жил x мм <sup>2</sup> (экран.)	4 x 1.25	4 x 1.25		
	От блока распределителя до внутреннего блока		Кол-во жил x мм <sup>2</sup> (экран.)	4 x 0.75	4 x 0.75		
Автоматический выключатель (УЗО)			A	20	20		
Габаритные размеры			ШxВxГ	950 x 1,380 x 330	950 x 1,380 x 330		
Вес нетто			кг	88	88		
Расход воздуха			Номинал	м <sup>3</sup> /мин	120	120	
Уровень звукового давления	Охлаждение	Номинал	дБ(A)	53	53		
	Нагрев	Номинал	дБ(A)	55	55		
Уровень шума	Охлаждение	Макс	дБ(A)	67	68		
Компрессор			Тип	Спиральный	Спиральный		
Хладагент			Тип	R410A	R410A		
			Заводская заправка	г	4 200	4 200	
Диаметры трубопроводов			Жидкость	мм (дюймы) x кол-во	Ø9.52 (3/8)	Ø9.52 (3/8)	
			Газ	мм (дюймы) x кол-во	Ø19.05 (3/4)	Ø19.05 (3/4)	
Максимальная длина трубопроводов			Общая длина трассы	м	135	145	
			До каждого внутреннего блока	м	55	55	
			Суммарная длина ответвлений	м	80	90	
			От блока распределителя до внутрен. блока	м	15	15	
Макс. перепад высот			Внутр - Наружн	Макс	м	30	30
			Внутр - Внутр	Макс	м	15	15
Температурный диапазон			Охлаждение	Мин-Макс	°C CT	-10 - 48	-10 - 48
			Нагрев	Мин-Макс	°C BT	-18 - 18	-18 - 18

# АКСЕССУАРЫ ДЛЯ НАРУЖНЫХ БЛОКОВ

Аксессуары для наружного блока		
Центральный контроллер AC EZ	Упрощенный центральный контроллер AC EZ Touch	Плата PI485
 PQCSZ250S0	 PACS4B000	 PMNFP14A1

## Упрощенный центральный контроллер AC EZ



PQCSZ250S0

- Команды: вкл/выкл, частота вращения вент-ра, режим работы, тем-ра воздуха
- Максимальное управление до 32 внутренних блоков
- Индикатор режима работы и график работы до 8 событий
- Требуется плата PI485
- Блокировка индивидуальных пультов управления
- Электропитание DC 12В

\* аксессуар совместим со всеми моделями, кроме MU2M15 и MU2M17

## Упрощенный центральный контроллер AC EZ Touch



PACS4B000

- Команды: вкл/выкл, частота вращения вентилятора, режим работы, температура воздуха
- Максимальное управление до 64 внутренних блоков
- Удаленный доступ через сеть Интернет (требуется присвоение публичного IP-адреса)
- Индикатор режима работы
- График работы до 8 событий
- Блокировка индивидуальных пультов управления
- Электропитание DC 12В.

\* аксессуар совместим со всеми моделями, кроме MU2M15 и MU2M17

## Плата PI485



PMNFP14A1

- Плата PI485 преобразует протокол системы кондиционирования в протокол RS485 центрального контроллера

\* аксессуар совместим со всеми моделями, кроме MU2M15 и MU2M17

# ДОЗАПРАВКА СИСТЕМЫ MULTI F

## Способ расчета количества фреона при необходимости дозаправки системы

Дополнительная заправка хладагента (г) =  
 ((Длина трубопровода в помещении А - 7,5) x 20 г/м +  
 (Длина трубопровода в помещении В - 7,5) x 20 г/м + ...) - ((CF\* Коэффициент коррекции) x 150)

\* CF = Максимальное число подключаемых внутренних блоков - общее число подключенных внутренних блоков

### Пример №1

Модель: MU5M30

Максимально возможное кол-во подключаемых внутренних блоков: 5

Кол-во внутренних блоков, подключаемых к данной системе (пример): 3

Длина трубопровода в помещении А = 10 м

Длина трубопровода в помещении В = 8 м

Длина трубопровода в помещении С = 18 м

Дополнительная заправка хладагента (г) = ((10 - 7,5) x 20 г/м + (8 - 7,5) x 20 г/м + (18 - 7,5) x 20 г/м) - ((5 - 3) x 150) = -30 г

При отрицательном результате дополнительная заправка не требуется!

### Пример №2

Модель: MU5M30

Максимально возможное кол-во подключаемых внутренних блоков: 5

Кол-во внутренних блоков, подключаемых к данной системе (пример): 5

Длина трубопровода в помещении А = 10 м

Длина трубопровода в помещении В = 8 м

Длина трубопровода в помещении С = 18 м

Длина трубопровода в помещении D = 12 м

Длина трубопровода в помещении E = 5 м

Дополнительная заправка хладагента (г) = ((10 - 7,5) x 20 г/м + (8 - 7,5) x 20 г/м + (18 - 7,5) x 20 г/м + (12 - 7,5) x 20 г/м + (5 - 7,5) x 20 г/м) - ((5-5)x150) = 310 г

Дополнительная заправка системы составит 310 г

# MULTI F DX

Пример: схема с распределителем, 1Ø, 11,7 кВт/ч

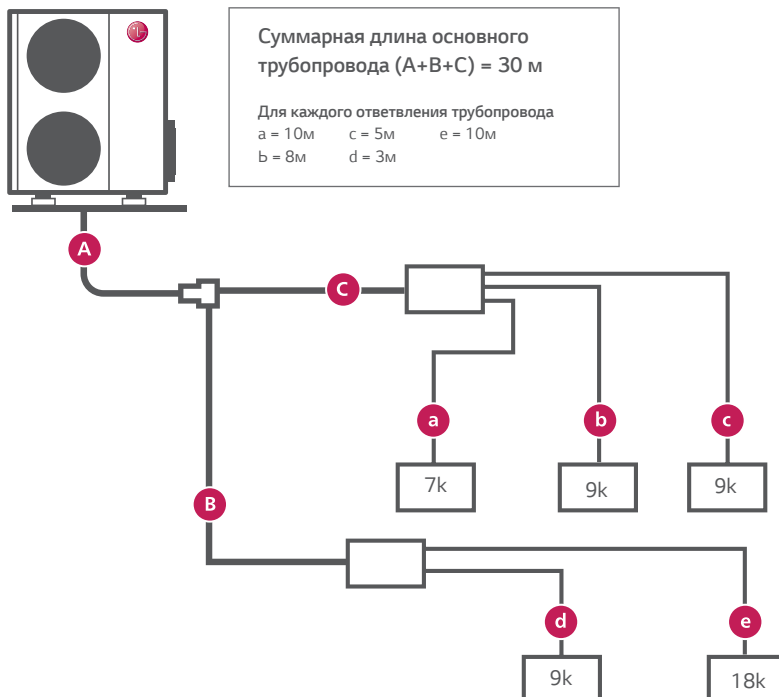

### Использование блока-распределителя

Дополнительная заправка (г) =  
 ((Длина основного трубопровода - Стандартная длина) x 50 г/м  
 + (Длина ответвления в помещении А - Стандартная длина) x 20 г/м + ...  
 + (Длина ответвления в помещении В - Стандартная длина) x 20 г/м  
 + (Длина ответвления в помещении С - Стандартная длина) x 20 г/м + ...)  
 - CF (Коэффициент коррекции) x 100 \*  
 CF = Максимальное число подключаемых внутренних блоков  
 - Общее число подключенных внутренних блоков

Дополнительная заправка =  
 ((30-5) x 50 + (10-5) x 20 + (8-5) x 20  
 + (5-5) x 20 + (3-5) x 20 + (10-5) x 20)  
 - (7-5) x 100 = 1270 г

\*При отрицательном результате дополнительная заправка не требуется!



# ВНУТРЕННИЕ БЛОКИ



# Настенный тип ARTCOOL | Gallery

## Уникальный дизайн

Сменные изображения передней панели и нестандартный корпус квадратной формы делают внутренние блоки серии Gallery заметной деталью любого интерьера. Настенные блоки серии ARTCOOL отличаются современным дизайном и отделкой, и станут эффектным дополнением помещения



Как заменить изображение



ARTCOOL Mirror / Deluxe / Standard Plus



Artcool Mirror - зеркальный  
AM07/09/12/18/24BP



Deluxe  
DM07/09/12/18/24RP



Standard Plus  
PM05/07/09/12/15/18/24SP

## Возможности Wi-Fi управления

Каждый член Вашей семьи может выбрать необходимые настройки управления кондиционером (желаемую температуру, скорость вентилятора и т.д.) и сохранить в своем приложении для того, чтобы очень просто использовать их позднее.

### Управление кондиционером с разных устройств



\*может управляться несколькими пользователями, но не одновременно

### Управления разными кондиционерами одним устройством



## Подача воздуха в трех направлениях

В зависимости от выбранного режима воздушный поток может быть изменен для более комфортного кондиционирования



Стандартный режим работы  
(подача воздуха в трех направлениях)



Форсированное охлаждение  
(подача воздуха вниз)

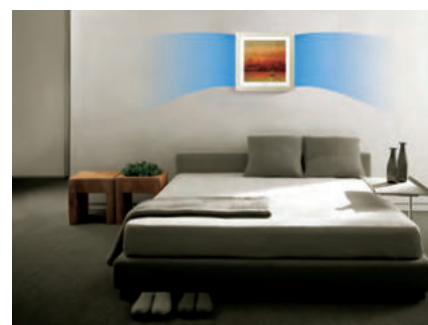

Ночной режим  
(подача воздуха в сторону)

# НАСТЕННЫЙ ТИП Standard Plus



PQWRHQ0FDB  
Входит в комплект поставки

- Современный дизайн
- Производительность от 1,5 до 6,6 кВт
- Wi-Fi управление
- Фильтр грубой очистки Антибактерия
- Система автоочистки Plasmaster

## Inverter

Внутренний блок				PM05SP.NS.IRO	PM07SP.NS.IRO	PM09SP.NS.IRO	PM12SP.NS.IRO	PM15SP.NS.IRO	PM18SP.NSKRO	PM24SP.NSKRO
Производительность	Охлаждение/Нагрев	Ном	кВт	1,5 / 1,6	2,1 / 2,3	2,65 / 3,2	3,5 / 3,8	4,2 / 5,4	5,0 / 5,8	6,6 / 7,5
Потребляемая мощность		Ном	Вт	30	30	30	30	30	60	60
Рабочий ток		Ном	А	0,1	0,1	0,2	0,2	0,2	0,3	0,3
Электропитание			В/Гц	1/220-240/50	1/220-240/50	1/220-240/50	1/220-240/50	1/220-240/50	1/220-240/50	1/220-240/50
Расход воздуха		Выс/Сред/Низк	м³/мин	8,3 / 6,7 / 5,7	9,7 / 8,2 / 5,7	10,2 / 8,4 / 5,7	10,7 / 9,2 / 5,7	11,2 / 10,1 / 6,1	14,2 / 11,3 / 9,9	15,2 / 12,7 / 10,2
Уровень шума		Выс/Сред/Низк	дБ(А)	34 / 31 / 27	35 / 32 / 27	36 / 33 / 27	40 / 35 / 27	41 / 36 / 29	44 / 38 / 35	46 / 41 / 36
Дегидратация			л/ч	0,9	0,9	1,1	1,2	1,2	1,9	2,6
Габаритные размеры	Корпус	Ш x В x Г	мм	837x308x189	837x308x189	837x308x189	837x308x189	837x308x189	998x345x210	998x345x210
Масса нетто	Корпус		кг	8,7	8,7	8,7	8,7	8,7	12,0	12,8
Диаметры трубопроводов	Жидкость		мм (дюймы)	ø 6,35 (1/4)	ø 6,35 (1/4)	ø 6,35 (1/4)	ø 6,35 (1/4)	ø 6,35 (1/4)	ø 6,35 (1/4)	ø 6,35 (1/4)
	Газ		мм (дюймы)	ø 9,52 (3/8)	ø 9,52 (3/8)	ø 9,52 (3/8)	ø 9,52 (3/8)	ø 9,52 (3/8)	ø 12,7 (1/2)	ø 12,7 (1/2)
	Дренаж		мм	16	16	16	16	16	16	16

Аксессуары:

PREMTB001 - Стандартный проводной пульт управления внутренним блоком

PDRCB400 - модуль сухого контакта для подключения размыкающих устройств

# НАСТЕННЫЙ ТИП Deluxe



PQWRHQ0FDB  
Входит в комплект поставки

- Внутренний блок серии Deluxe отличается стильным дизайном и улучшенными материалами корпуса.
- Производительность от 2,1 до 6,6 кВт
- Фильтр грубой очистки Антибактерия
- Wi-Fi управление
- Система автоочистки Plasmaster
- Система очистки воздуха Plasmaster Ionizer Plus



Сделано в Корее

## Inverter

Внутренний блок				DM07RP.NS.IRO	DM09RP.NS.IRO	DM12RP.NS.IRO	DM18RP.NSKRO	DM24RP.NSKRO
Производительность	Охлаждение/Нагрев	Ном	кВт	2,1 / 2,3	2,5 / 3,2	3,5 / 4,0	5,0 / 5,8	6,6 / 7,5
Потребляемая мощность		Ном	Вт	30	30	30	60	60
Рабочий ток		Ном	А	0,2	0,2	0,2	0,4	0,4
Электропитание			В/Гц	1/220-240/50	1/220-240/50	1/220-240/50	1/220-240/50	1/220-240/50
Расход воздуха		Выс/Сред/Низк	м³/мин	7,5 / 6,1 / 4,5	7,7 / 6,4 / 5,0	8,1 / 6,7 / 5,3	14,2 / 11,3 / 9,9	15,2 / 12,7 / 10,2
Уровень шума	Охлаждение	Выс/Сред/Низк	дБ(А)	35 / 31 / 26	36 / 32 / 27	38 / 34 / 29	44 / 38 / 34	47 / 41 / 36
Дегидратация			л/ч	0,9	1,1	1,2	1,9	2,6
Габаритные размеры	Корпус	Ш x В x Г	мм	837x308x189	837x308x189	837x308x189	998x345x210	998x345x210
Масса нетто	Корпус		кг	8,3	8,3	8,3	12,0	12,0
Диаметры трубопроводов	Жидкость		мм (дюймы)	ø 6,35 (1/4)	ø 6,35 (1/4)	ø 6,35 (1/4)	ø 6,35 (1/4)	ø 6,35 (1/4)
	Газ		мм (дюймы)	ø 9,52 (3/8)	ø 9,52 (3/8)	ø 9,52 (3/8)	ø 12,7 (1/2)	ø 12,7 (1/2)
	Дренаж		мм	16	16	16	16	16

Аксессуары:

PREMTB001 - Стандартный проводной пульт управления внутренним блоком

PDRCB400 - модуль сухого контакта для подключения размыкающих устройств

# НАСТЕННЫЙ ТИП Gallery

- Уникальный корпус внутреннего блока отличает его от любых аналогов
- Возможность смены изображений у Gallery
- Воздухораспределение 3D
- Производительность от 2,6 до 3,5 кВт
- Встроенный электростатический фильтр Plasma
- Сделан в Южной Корее



Сделано в Корее

## Inverter



PQWRHQ0FDB  
Входит в комплект поставки



MA09AH1 | MA12AH1

Внутренний блок				MA09AH1 NF1R0	MA12AH1 NF1R0
Производительность	Охлаждение/Нагрев	Ном	кВт	2,6 / 2,9	3,5 / 3,9
Потребляемая мощность		Ном	Вт	40	40
Рабочий ток		Ном	А	0,1	0,1
Электропитание			ø/В/Гц	1 / 220-240 / 50	1 / 220-240 / 50
Расход воздуха		Выс/Сред/Низк	м <sup>3</sup> /мин	7,7 / 5,9 / 4,4	8,9 / 7,3 / 5,6
Уровень шума	Охлаждение	Выс/Сред/Низк	дБ(А)	38 / 32 / 27	44 / 38 / 32
Дегидратация			л/ч	1,2	1,4
Габаритные размеры	Корпус	Ш x В x Г	мм	600x600x145	600x600x145
Масса нетто	Корпус		кг	15,0	15,0
Диаметры трубопроводов	Жидкость		мм (дюймы)	ø 6,35 (1/4)	ø 6,35 (1/4)
	Газ		мм (дюймы)	ø 9,52 (3/8)	ø 9,52 (3/8)
	Дренаж		мм	16	16

Аксессуары:

PDRYCB400 - модуль сухого контакта для подключения размыкающих устройств

# НАСТЕННЫЙ ТИП Artcool Mirror

- Дизайнерский внутренний блок с передней панелью из закаленного стекла.
- Производительность от 2,1 до 6,6 кВт
- Wi-Fi управление
- Фильтр грубой очистки Антибактерия
- Система автоочистки Plasmaster
- Система очистки воздуха Plasmaster Ionizer Plus



PQWRHQ0FDB  
Входит в комплект поставки



## Inverter

Внутренний блок				AM07BP .NSJRO	AM09BP .NSJRO	AM12BP .NSJRO	AM18BP .NSKRO	AM24BP .NSKRO
Производительность	Охлаждение/Нагрев	Ном	кВт	2,1 / 2,3	2,5 / 3,2	3,5 / 3,8	5,0 / 5,8	6,6 / 7,5
Потребляемая мощность		Ном	Вт	30	30	30	60	60
Рабочий ток		Ном	А	0,2	0,2	0,2	0,4	0,4
Электропитание			ø/В/Гц	1 / 220-240 / 50	1 / 220-240 / 50	1 / 220-240 / 50	1 / 220-240 / 50	1 / 220-240 / 50
Расход воздуха		Выс/Сред/Низк	м <sup>3</sup> /мин	9,7 / 8,2 / 5,7	10,2 / 8,4 / 5,7	10,7 / 9,2 / 5,7	14,2 / 11,3 / 9,9	15,2 / 12,7 / 10,2
Уровень шума	Охлаждение	Выс/Сред/Низк	дБ(А)	35 / 32 / 27	36 / 33 / 27	40 / 35 / 27	44 / 38 / 35	46 / 41 / 36
Дегидратация			л/ч	0,9	1,1	1,2	1,9	2,6
Габаритные размеры	Корпус	Ш x В x Г	мм	837x308x192	837x308x192	837x308x192	998x345x212	998x345x212
Масса нетто	Корпус		кг	9,9	9,9	9,9	13,2	13,2
Диаметры трубопроводов	Жидкость		мм (дюймы)	ø 6,35 (1/4)	ø 6,35 (1/4)	ø 6,35 (1/4)	ø 6,35 (1/4)	ø 6,35 (1/4)
	Газ		мм (дюймы)	ø 9,52 (3/8)	ø 9,52 (3/8)	ø 9,52 (3/8)	ø 12,7 (1/2)	ø 12,7 (1/2)
	Дренаж		мм	16	16	16	16	16

Аксессуары:

PREMTB001 - Стандартный проводной пульт управления внутренним блоком

PDRYCB400 - модуль сухого контакта для подключения размыкающих устройств

# КАССЕТНЫЙ ТИП MT | CT



## Inverter

- Индивидуальное управление каждой створкой жалюзи
- Размер каждой створки жалюзи 80 мм, что обеспечивает равномерное воздухораспределение
- Максимальная высота монтажа - 4,2 м
- Упрощенный монтаж за счет использования съемных угловых панелей
- ИК-приемник на корпусе внутреннего блока
- Встроенный дренажный насос 700мм
- Сделан в Южной Корее

Производительность (кВт)	1,5		2,1		2,6		3,5		5,3		6,7	
1-поточный кассетный блок					MT09AH	MT11AH						
4-поточный кассетный блок			MT06AH	MT08AH	CT09	CT12	CT18	CT24				

Внутренний блок				MT09AH NU1R0	MT11AH NU1R0	MT06AH NR0R0	MT08AH NR0R0
Производительность	Охлаждение/Нагрев	Ном	кВт	2,6 / 2,9	3,5 / 3,9	1,5 / 1,6	2,1 / 2,3
Потребляемая мощность		Мин/Ном/Макс	Вт	-/20/-	-/20/-	10/20/20	10/20/20
Рабочий ток	Охлаждение/нагрев	Ном	А	0,2	0,2	0,4	0,4
Электропитание			φ/В/Гц	1 / 220-240 / 50	1 / 220-240 / 50	1 / 220-240 / 50	1 / 220-240 / 50
Расход воздуха		Выс/Сред/Низк	м³/мин	7,5 / 7,3 / 6,8	8,1 / 7,4 / 7,0	7,5 / 6,0 / 5,0	7,5 / 6,0 / 5,0
Уровень шума	Охлаждение	Выс/Сред/Низк	дБ(А)	36 / 34 / 32	37 / 36 / 33	31 / 27 / 24	31 / 27 / 24
Дегитратация			л/ч	1,1	1,2	0,8	1
Габаритные размеры	Корпус	ШхВхГ	мм	860×132×450	860×132×450	570×214×570	570×214×570
Масса нетто	Корпус		кг	13,5	13,5	14,0	14,0
Диаметры трубопроводов	Жидкость		мм (дюймы)	ø 6,35 (1/4)	ø 6,35 (1/4)	ø 6,35 (1/4)	ø 6,35 (1/4)
	Газ		мм (дюймы)	ø 9,52 (3/8)	ø 9,52 (3/8)	ø 9,52 (3/8)	ø 9,52 (3/8)
Передняя панель	Модель			PT-UUC	PT-UUC	PT-UQC	PT-UQC
	Цвет			Белый	Белый	Белый	Белый
	Размеры	ШхВхГ	мм	1100×34×500	1100×34×500	700×30×700	700×30×700
	Масса		кг	4,4	4,4	3,0	3,0

Внутренний блок				CT09 NR2R0	CT12 NR2R0	CT18 NQ2R0	CT24 NP2R0
Производительность	Охлаждение/Нагрев	Ном	кВт	2,6 / 2,9	3,5 / 3,9	5,3 / 5,8	6,7 / 7,5
Потребляемая мощность		Мин/Ном/Макс	Вт	10 / 20 / 20	10 / 20 / 20	10 / 30 / 40	20 / 50 / 60
Рабочий ток	Охлаждение/нагрев	Ном	А	0,4	0,4	0,4	0,6
Электропитание			φ/В/Гц	1 / 220-240 / 50	1 / 220-240 / 50	1 / 220-240 / 50	1 / 220-240 / 50
Расход воздуха		Выс/Сред/Низк	м³/мин	8,5 / 7,0 / 6,0	9,5 / 8,0 / 7,0	13,0 / 12,0 / 11,0	17,0 / 15,0 / 13,0
Уровень шума	Охлаждение	Выс/Сред/Низк	дБ(А)	36 / 33 / 30	38 / 35 / 32	41 / 39 / 36	38 / 36 / 34
Дегитратация			л/ч	1,4	1,7	2,1	2,4
Габаритные размеры	Корпус	ШхВхГ	мм	570×214×570	570×214×570	570×256×570	840×204×840
Масса нетто	Корпус		кг	14,0	14,0	15,5	20,5
Диаметры трубопроводов	Жидкость		мм (дюймы)	ø 6,35 (1/4)	ø 6,35 (1/4)	ø 6,35 (1/4)	ø 9,52 (3/8)   ø 6,35 (1/4)*
	Газ		мм (дюймы)	ø 9,52 (3/8)	ø 9,52 (3/8)	ø 12,7 (1/2)	ø 15,88 (5/8)   ø 12,7 (1/2)*
Передняя панель	Модель			PT-UQC	PT-UQC	PT-UQC	PT-UMC1
	Цвет			Белый	Белый	Белый	Белый
	Размеры	ШхВхГ	мм	700×30×700	700×30×700	700×30×700	950×25×950
	Масса		кг	3,0	3,0	3,0	5,0

\* Для подключения блока CT24 к наружному блоку мульти сплит-системы Multi F или блоку-распределителю системы Multi FDX необходимо использовать переходники, поставляемые в комплекте с внутренним блоком. При этом переходник с 3/8" на 1/4" устанавливается на жидкостный порт внутреннего блока; переходник с 3/8" на 1/2" устанавливается на газовый порт наружного блока или блока-распределителя, переходник с 5/8" на 1/2" устанавливается на газовый порт внутреннего блока. Соединительные трубопроводы прокладываются следующих типоразмеров: газовый трубопровод 1/2", жидкостный трубопровод 1/4"

Аксессуары:

PTEGMO - автоматически опускающаяся передняя панель для очистки воздушного фильтра внутреннего блока (для модели CT24)

PTDCQ - декоративная передняя панель для установки 4-х поточного блока не за подшивным потолком

(для моделей MT06AH, MT08AH, CT09, CT12 и CT18)

PTDCM - декоративная передняя панель для установки 4-х поточного блока не за подшивным потолком (для модели CT24)

PRDRCB400 - модуль сухого контакта для подключения размыкающих устройств

- Поддержание расхода воздуха и уровня шума на уровне расчетного значения независимо от напора вентилятора
- Возможность независимого кондиционирования до 4-х помещений с помощью зонального контроллера (ABZCA - поставляется опционально)
- Возможность кондиционирования до 9-ти зон (9 воздуховодов) с одинаковыми температурными параметрами
- Дренажный насос 700 мм (ABDPG - поставляется опционально для моделей CM)
- Сделан в Южной Корее

# КАНАЛЬНЫЙ ТИП

## CB | CM

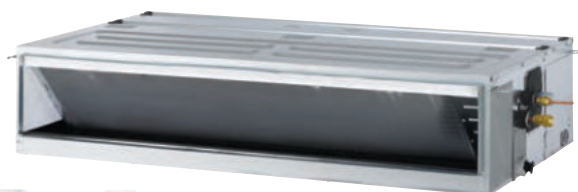

PREMTB001  
Входит в комплект поставки









PQWRHQ0FDB  
Приобретается отдельно



Сделано в Корее

## Inverter

Производительность (кВт)	2,6	3,5	5,3	6,7
Низко-напорный	 CB09L	 CB12L	 CB18L	 CB24L
Средне-напорный	 CM18		 CM24	

Внутренний блок				CB09L N12R0	CB12L N22R0	CB18L N22R0	CB24L N32R0
Производительность	Охлаждение/Нагрев	Ном	кВт	2,6 / 2,9	3,5 / 3,9	5,3 / 5,8	6,7 / 7,7
Потребляемая мощность		Мин/Ном/Макс (25 Па)	Вт	30 / 50 / 50	80 / 95 / 95	95 / 120 / 120	90 / 150 / 150
		Мин/Макс (50 Па)		40 / 60	80 / 100	100 / 140	110 / 160
Рабочий ток	Охлаждение/нагрев	Ном	А	0,4	0,8	0,8	1,0
Электропитание			В/Гц	1 / 220-240 / 50	1 / 220-240 / 50	1 / 220-240 / 50	1 / 220-240 / 50
Расход воздуха		Выс/Сред/Низк	м <sup>3</sup> /мин	9,0 / 7,0 / 5,5	10,0 / 8,5 / 7,0	15,0 / 12,5 / 10,0	20,0 / 16,0 / 12,0
Уровень шума	Охлаждение	Выс/Сред/Низк	дБ(А)	30 / 26 / 23	31 / 28 / 27	36 / 34 / 31	39 / 35 / 32
Дегитратация			л/ч	1,1	1,2	1,7	2,2
Габаритные размеры	Корпус	ШхВхГ	мм	700x190x700	900x190x700	900x190x700	1100x190x700
Масса нетто	Корпус		кг	17,5	23,0	23,0	27,0
Диаметры трубопроводов	Жидкость		мм (дюймы)	ø 6,35 (1/4)	ø 6,35 (1/4)	ø 6,35 (1/4)	ø 9,52 (3/8)   ø 6,35 (1/4)*
	Газ		мм (дюймы)	ø 9,52 (3/8)	ø 9,52 (3/8)	ø 12,7 (1/2)	ø 15,88 (5/8)   ø 12,7 (1/2)*
Напор вентилятора			Па	25 (0 ~ 50)	25 (0 ~ 50)	25 (0 ~ 50)	25 (0 ~ 50)

Внутренний блок				CM18 N14R0	CM24 N14R0
Производительность	Охлаждение/Нагрев	Ном	кВт	5,3 / 5,8	6,7 / 7,7
Потребляемая мощность		Мин/Ном/Макс (25 Па)	Вт	50 / 80	50 / 90
		Мин/Макс (50 Па)		90 / 160	100 / 180
Рабочий ток	Охлаждение/нагрев	Ном	А	0,4	0,5
Электропитание			В/Гц	1 / 220-240 / 50	1 / 220-240 / 50
Расход воздуха		Выс/Сред/Низк	м <sup>3</sup> /мин	16,5 / 14,5 / 13,0	18,0 / 16,5 / 14,5
Уровень шума	Охлаждение	Выс/Сред/Низк	дБ(А)	34 / 32 / 30	35 / 34 / 32
Дегитратация			л/ч	2,0	2,5
Габаритные размеры	Корпус	ШхВхГ	мм	900x270x700	900x270x700
Масса нетто	Корпус		кг	24,0	24,0
Диаметры трубопроводов	Жидкость		мм (дюймы)	ø 6,35 (1/4)	ø 9,52 (3/8)   ø 6,35 (1/4)*
	Газ		мм (дюймы)	ø 12,7 (1/2)	ø 15,88 (5/8)   ø 12,7 (1/2)*
Напор вентилятора			Па	60 (25 ~ 150)	60 (25 ~ 150)

\* Для подключения блоков CM24 и CB24L к наружному блоку мульти сплит-системы Multi F или блоку-распределителю системы Multi FDX необходимо использовать переходники, поставляемые в комплекте с внутренним блоком. При этом переходник с 3/8" на 1/4" устанавливается на жидкостной порт внутреннего блока, переходник с 3/8" на 1/2" устанавливается на газовый порт наружного блока или блока-распределителя; переходник с 5/8" на 1/2" устанавливается на газовый порт внутреннего блока. Соединительные трубопроводы прокладываются следующих типоразмеров: газовый трубопровод 1/2", жидкостный трубопровод 1/4"

### Аксессуары:

ABZCA - зональный контроллер. Позволяет индивидуально кондиционировать до 4-х отдельных зон (тем-ра, вкл/выкл)  
 PQCSZ25050 - центральный контроллер AC EZ для управления группой до 32 внутренних блоков  
 PDRYCB400 - модуль сухого контакта для подключения размыкающих устройств  
 ABDPG - Дренажный насос для блоков канального типа

# НАПОЛЬНО-ПОТОЛОЧНЫЙ ТИП CV



- Различные варианты монтажа (стена | потолок)
- Распределение воздуха по горизонтали и вертикали
- Работа по двум температурным датчикам (при подключении проводного пульта)
- Сделан в Южной Корее



Сделано в Корее

## Inverter



PQWRHQFDB  
Входит в комплект поставки



PREMTB001  
Приобретается отдельно

Производительность (кВт)		2,6	3,5
Напольно-потолочный		CV09	CV12

Внутренний блок				CV09 NE2R0	CV12 NE2R0
Производительность	Охлаждение/Нагрев	Ном	кВт	2,6 / 2,9	3,5 / 3,9
Потребляемая мощность		Мин/Ном/Макс	Вт	10 / 30	20 / 40
Рабочий ток	Охлаждение/нагрев	Ном	А	0,4	0,4
Электропитание			ø/В/Гц	1 / 220-240 / 50	1 / 220-240 / 50
Расход воздуха		Выс/Сред/Низк	м <sup>3</sup> /мин	7,6 / 6,9 / 6,2	9,2 / 7,6 / 6,6
Уровень шума	Охлаждение	Выс/Сред/Низк	дБ(А)	38 / 35 / 32	40 / 36 / 31
Дегитратация			л/ч	1,2	1,2
Габаритные размеры	Корпус	ШxВxГ	мм	900×490×200	900×490×200
Масса нетто	Корпус		кг	13,7	13,7
Диаметры трубопроводов	Жидкость		мм (дюймы)	ø 6,35 (1/4)	ø 6,35 (1/4)
	Газ		мм (дюймы)	ø 9,52 (3/8)	ø 9,52 (3/8)

Аксессуары:

PDRYCB400 - модуль сухого контакта для подключения размыкающих устройств

# КОНСОЛЬНЫЙ ТИП CQ

- Стильный дизайн
- Низкий уровень шума
- Компактные размеры
- Режим нагрева пола (усиленный теплый воздушный поток из нижней створки направлен вдоль поверхности пола)
- 5 ступеней регулировки направления створок жалюзи
- Сделан в Южной Корее



Сделано в Корее



## Inverter



PQRWHQ0FDB  
Входит в комплект поставки



PREMTB001  
Приобретается отдельно

Производительность (кВт)		2,6	3,5	5,3
Консольный тип	 	CQ09	CQ12	CQ18

Внутренний блок				CQ09 NA0R0
Производительность	Охлаждение/Нагрев	Ном	кВт	2,6 / 2,9
Потребляемая мощность		Мин/Ном/Макс	Вт	10 / 20
Рабочий ток	Охлаждение/нагрев	Ном	А	0,6
Электропитание			В/Гц	1 / 220-240 / 50
Расход воздуха		Выс/Сред/Низк	м <sup>3</sup> /мин	8,5 / 6,7 / 5,0
Уровень шума	Охлаждение	Выс/Сред/Низк	дБ(А)	38 / 32 / 27
Дегитратация			л/ч	1,2
Габаритные размеры	Корпус	ШхВхГ	мм	700×600×210
Масса нетто	Корпус		кг	14,0
Диаметры трубопроводов	Жидкость		мм (дюймы)	ø 6,35 (1/4)
	Газ		мм (дюймы)	ø 9,52 (3/8)

Внутренний блок				CQ12 NA0R0	CQ18 NA0R0
Производительность	Охлаждение/Нагрев	Ном	кВт	3,5 / 3,9	5,3 / 5,8
Потребляемая мощность		Мин/Ном/Макс	Вт	10 / 30	20 / 40
Рабочий ток	Охлаждение/нагрев	Ном	А	0,6	0,7
Электропитание			В/Гц	1 / 220-240 / 50	1 / 220-240 / 50
Расход воздуха		Выс/Сред/Низк	м <sup>3</sup> /мин	9,0 / 6,9 / 5,2	10,1 / 8,6 / 7,2
Уровень шума	Охлаждение	Выс/Сред/Низк	дБ(А)	39 / 32 / 27	44 / 39 / 35
Дегитратация			л/ч	1,4	2,3
Габаритные размеры	Корпус	ШхВхГ	мм	700×600×210	700×600×210
Масса нетто	Корпус		кг	14,0	14,0
Диаметры трубопроводов	Жидкость		мм (дюймы)	ø 6,35 (1/4)	ø 6,35 (1/4)
	Газ		мм (дюймы)	ø 9,52 (3/8)	ø 12,7 (1/2)

Аксессуары:

PDRYCB400 - модуль сухого контакта для подключения размыкающих устройств



# БЛОКИ РАСПРЕДЕЛИТЕЛИ И РАЗВЕТВИТЕЛИ

## Блок-распределитель

PMBD3620, PMBD3630, PMBD3640

Технологичный монтаж с помощью различных блоков-распределителей

Для	2-х внутренних блоков	3-х внутренних блоков	4-х внутренних блоков
Блок-распределитель	 PMBD3620	 PMBD3630	 PMBD3640

С помощью блоков-распределителей различного типа можно существенно упростить монтаж системы на любом объекте

### Возможности

- Распределение хладагента к нескольким внутренним блокам
- 3 модели (на 2, 3 или 4 внутренних блока)
- Электронный расширительный вентиль
- Управляющая печатная плата внутри блока
- Внутренняя изоляция (предотвращает возможные утечки)
- Резьбовые соединения гарантируют простую и чистую установку
- Компактный низкопрофильный дизайн
- Упрощенный монтаж



Без сварки

Только резьбовые соединения

### Технические характеристики

Модель	PMBD3620		PMBD3630		PMBD3640	
Присоединяемые внутренние блоки	Кол-во внутренних блоков	1-2	1-3	1-3	1-4	1-4
	Производительность	кБТЕ/ч	5 / 7 / 9 / 12 / 15 / 18 / 24	5 / 7 / 9 / 12 / 15 / 18 / 24	5 / 7 / 9 / 12 / 15 / 18 / 24	5 / 7 / 9 / 12 / 15 / 18 / 24
Электропитание		кВ/Гц	1 / 220 ~ 240 / 50	1 / 200 ~ 240 / 50	1 / 200 ~ 240 / 50	1 / 200 ~ 240 / 50
Потребляемая мощность		Вт	10	10	10	10
Рабочий ток		А	0,05	0,05	0,05	0,05
Габаритные размеры	ШхВхГ	мм	302 × 143 × 252	302 × 143 × 252	302 × 143 × 252	302 × 143 × 252
Вес нетто		кг	4,8	4,9	5	5
Диаметры трубопроводов (к наружному блоку)	Жидкость	Ø мм (дюймы)	Ø 9,52 (3/8)	Ø 9,52 (3/8)	Ø 9,52 (3/8)	Ø 9,52 (3/8)
	Газ	Ø мм (дюймы)	Ø 19,05 (3/4)	Ø 19,05 (3/4)	Ø 19,05 (3/4)	Ø 19,05 (3/4)
Диаметры трубопроводов (к внутреннему блоку)	Жидкость	Ø мм (дюймы)	Ø 6,35 (1/4) × 2шт	Ø 6,35 (1/4) × 3шт	Ø 6,35 (1/4) × 4шт	Ø 6,35 (1/4) × 4шт
	Газ	Ø мм (дюймы)	Ø 9,52 (3/8) × 2шт	Ø 9,52 (3/8) × 3шт	Ø 9,52 (3/8) × 4шт	Ø 9,52 (3/8) × 4шт
Принадлежности	Кронштейн	шт	4	4	4	4
	Винт	шт	8	8	8	8
	Инструкция	шт	1	1	1	1

Примечание.

1. Трубное соединение должно соответствовать размеру трубок подключаемого внутреннего блока.  
(Используйте переходники из комплекта поставки внутреннего блока для изменения диаметра трубопроводов (для моделей СТ24 | CM24 | CB24L))
2. Блок-распределитель должен быть установлен в помещении.

## Разветвители

PMBL5620 (2 блока) / PMBL1203F0 (3 блока)



### Возможности

- Разветвители значительно упрощают монтаж систем Multi FDX
- В модельном ряду представлены разветвители для газа и жидкости.
- Изоляционный материал для изоляции разветвителей входит в комплект поставки.

### Гидравлическая схема

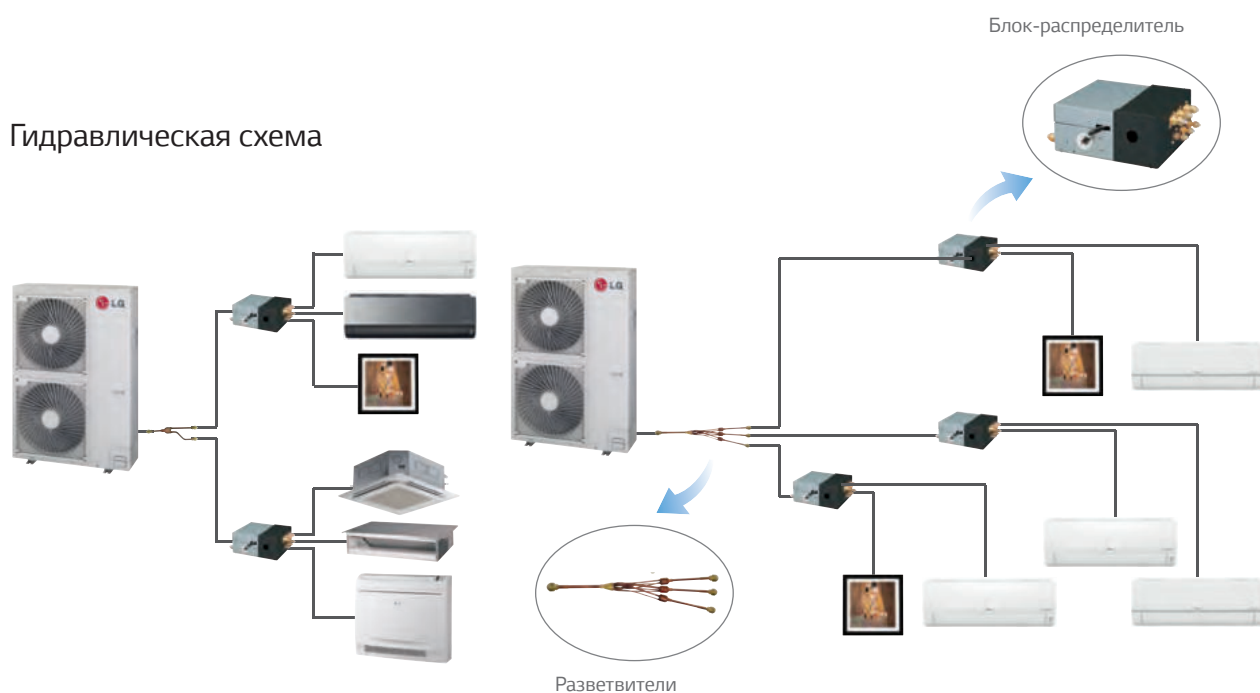

### Технические характеристики

(Ед. изм. : мм)

Модель	Количество объединяемых блоков-распределителей	Разветвители	
		Газ	Жидкость
PMBL5620	2 блока		
PMBL1203F0	3 блока		

# MU2M15

Режим работы	Комбинации внутренних блоков (кВт/ч)			Охлаждение										
				Производительность (кВт)		Общая производительность						Потребляемая мощность (Вт)		
				БЛОК А	БЛОК В	Всего	Минимум		Номинал		Максимум		Минимум	Номинал
БЛОК А	БЛОК В	Бте/ч	кВт				Бте/ч	кВт	Бте/ч	кВт				
1 Блок	5	-	5	1.5	-	3,000	0.9	5,000	1.5	5,750	1.7	229	386	483
	7	-	7	2.1	-	4,200	1.2	7,000	2.1	8,050	2.4	307	547	692
	9	-	9	2.6	-	5,400	1.6	9,000	2.6	10,350	3.0	412	684	875
	12	-	12	3.5	-	7,200	2.1	12,000	3.5	13,800	4.0	547	937	1,190
2 Блока	5	5	10	1.5	1.5	6,000	1.8	10,000	2.9	11,500	3.4	419	691	900
	5	7	12	1.5	2.1	7,200	2.1	12,000	3.5	13,800	4.0	492	843	1,120
	5	9	14	1.5	2.6	8,400	2.5	14,000	4.1	16,100	4.7	591	1,000	1,379
	7	7	14	2.1	2.1	8,400	2.5	14,000	4.1	16,100	4.7	591	1,000	1,379
	7	9	16	2.1	2.6	8,400	2.5	14,000	4.1	16,100	4.7	591	1,000	1,379
	5	12	17	1.5	3.5	8,400	2.5	14,000	4.1	16,100	4.7	591	1,000	1,379
	9	9	18	2.6	2.6	8,400	2.5	14,000	4.1	16,100	4.7	591	1,000	1,379
	7	12	19	2.1	3.5	8,400	2.5	14,000	4.1	16,100	4.7	591	1,000	1,379
9	12	21	2.6	3.5	8,400	2.5	14,000	4.1	16,100	4.7	591	1,000	1,379	

Примечание:

1. Производительность охлаждения указана для следующих условий: температура в помещении 27 °Сст / 19 °Свт; температура наружного воздуха 35 °Сст
2. Производительность нагрева указана для следующих условий: температура в помещении 20 °Сст; температура наружного воздуха 7 °Сст / 6 °Сст
3. Общая производительность подключенных внутренних блоков не должна превышать 21 кВт/ч

Режим работы	Комбинации внутренних блоков (кВт/ч)			Нагрев										
				Производительность (кВт)		Общая производительность						Потребляемая мощность (Вт)		
				БЛОК А	БЛОК В	Всего	Минимум		Номинал		Максимум		Минимум	Номинал
БЛОК А	БЛОК В	Бте/ч	кВт				Бте/ч	кВт	Бте/ч	кВт				
1 Блок	5	-	5	1.6	-	3,300	1.0	5,500	1.6	6,050	1.8	235	380	472
	7	-	7	2.5	-	5,040	1.5	8,400	2.5	9,240	2.7	355	604	721
	9	-	9	3.2	-	6,480	1.9	10,800	3.2	11,880	3.5	454	784	949
	12	-	12	3.9	-	7,920	2.3	13,200	3.9	14,520	4.3	554	969	1,185
2 Блока	5	5	10	1.6	1.6	6,600	1.9	11,000	3.2	12,100	3.5	408	706	854
	5	7	12	1.6	2.5	7,920	2.3	13,200	3.9	14,520	4.3	498	872	1,066
	5	9	14	1.6	3.2	9,600	2.8	16,000	4.7	18,400	5.4	613	1,068	1,451
	7	7	14	2.5	2.5	9,600	2.8	16,000	4.7	18,400	5.4	613	1,068	1,451
	7	9	16	2.5	3.2	9,600	2.8	16,000	4.7	18,400	5.4	613	1,068	1,451
	5	12	17	1.6	3.9	9,600	2.8	16,000	4.7	18,400	5.4	613	1,068	1,451
	9	9	18	3.2	3.2	9,600	2.8	16,000	4.7	18,400	5.4	613	1,068	1,451
	7	12	19	2.5	3.9	9,600	2.8	16,000	4.7	18,400	5.4	613	1,068	1,451
9	12	21	3.2	3.9	9,600	2.8	16,000	4.7	18,400	5.4	613	1,068	1,451	

Примечание:

1. Производительность охлаждения указана для следующих условий: температура в помещении 27 °Сст / 19 °Свт; температура наружного воздуха 35 °Сст
2. Производительность нагрева указана для следующих условий: температура в помещении 20 °Сст; температура наружного воздуха 7 °Сст / 6 °Сст
3. Общая производительность подключенных внутренних блоков не должна превышать 21 кВт/ч

# MU2M17

Режим работы	Комбинации внутренних блоков (кВт/ч)			Охлаждение										
				Производительность (кВт)		Общая производительность						Потребляемая мощность (Вт)		
				БЛОК А	БЛОК В	Минимум		Номинал		Максимум		Минимум	Номинал	Максимум
Бте/ч	кВт	Бте/ч	кВт			Бте/ч	кВт							
1 Блок	БЛОК А	БЛОК В	Всего	БЛОК А	БЛОК В	Бте/ч	кВт	Бте/ч	кВт	Бте/ч	кВт	Минимум	Номинал	Максимум
	5	-	5	1.5	-	3,000	0.9	5,000	1.5	5,750	1.7	229	386	483
	7	-	7	2.1	-	4,200	1.2	7,000	2.1	8,050	2.4	307	547	692
	9	-	9	2.6	-	5,400	1.6	9,000	2.6	10,350	3.0	412	684	875
	12	-	12	3.5	-	7,200	2.1	12,000	3.5	13,800	4.0	547	937	1,190
	15	-	15	4.4	-	8,520	2.5	14,200	4.2	16,330	4.8	656	1,196	1,588
2 Блока	5	5	10	1.5	1.5	6,000	1.8	10,000	2.9	11,500	3.4	419	691	900
	5	7	12	1.5	2.1	7,200	2.1	12,000	3.5	13,800	4.0	492	843	1,071
	5	9	14	1.5	2.6	8,400	2.5	14,000	4.1	16,100	4.7	591	1,000	1,379
	7	7	14	2.1	2.1	8,400	2.5	14,000	4.1	16,100	4.7	591	1,000	1,379
	7	9	16	2.1	2.6	9,600	2.8	16,000	4.7	18,400	5.4	665	1,253	1,699
	5	12	17	1.5	3.5	9,600	2.8	16,000	4.7	18,400	5.4	665	1,253	1,699
	9	9	18	2.6	2.6	9,600	2.8	16,000	4.7	18,400	5.4	665	1,253	1,699
	7	12	19	2.1	3.5	9,600	2.8	16,000	4.7	18,400	5.4	665	1,253	1,699
	5	15	20	1.5	4.4	9,600	2.8	16,000	4.7	18,400	5.4	665	1,253	1,699
	9	12	21	2.6	3.5	9,600	2.8	16,000	4.7	18,400	5.4	665	1,253	1,699
	7	15	22	2.1	4.4	9,600	2.8	16,000	4.7	18,400	5.4	665	1,253	1,699
	9	15	24	2.6	4.4	9,600	2.8	16,000	4.7	18,400	5.4	665	1,253	1,699
		12	12	24	3.5	3.5	9,600	2.8	16,000	4.7	18,400	5.4	665	1,253

Примечание:

1. Производительность охлаждения указана для следующих условий: температура в помещении 27 °Сст / 19 °Свт; температура наружного воздуха 35 °Сст
2. Производительность нагрева указана для следующих условий: температура в помещении 20 °Сст; температура наружного воздуха 7 °Сст / 6 °Сст
3. Общая производительность подключенных внутренних блоков не должна превышать 24 кВт/ч

Режим работы	Комбинации внутренних блоков (кВт/ч)			Нагрев										
				Производительность (кВт)		Общая производительность						Потребляемая мощность (Вт)		
				БЛОК А	БЛОК В	Минимум		Номинал		Максимум		Минимум	Номинал	Максимум
Бте/ч	кВт	Бте/ч	кВт			Бте/ч	кВт							
1 Блок	БЛОК А	БЛОК В	Всего	БЛОК А	БЛОК В	Бте/ч	кВт	Бте/ч	кВт	Бте/ч	кВт	Минимум	Номинал	Максимум
	5	-	5	1.6	-	3,300	1.0	5,500	1.6	6,050	1.8	235	380	472
	7	-	7	2.5	-	5,040	1.5	8,400	2.5	9,240	2.7	355	604	721
	9	-	9	3.2	-	6,480	1.9	10,800	3.2	11,880	3.5	454	758	920
	12	-	12	3.9	-	7,920	2.3	13,200	3.9	14,520	4.3	554	942	1,155
	15	-	15	4.8	-	9,900	2.9	16,500	4.8	18,150	5.3	706	1,187	1,504
2 Блока	5	5	10	1.6	1.6	6,600	1.9	11,000	3.2	12,100	3.5	408	706	854
	5	7	12	1.6	2.5	7,920	2.3	13,200	3.9	14,520	4.3	498	872	1,066
	5	9	14	1.6	3.2	9,600	2.8	16,000	4.7	18,400	5.4	613	1,068	1,451
	7	7	14	2.5	2.5	9,600	2.8	16,000	4.7	18,400	5.4	613	1,068	1,451
	7	9	16	2.5	3.2	10,800	3.2	18,000	5.3	19,400	5.7	706	1,197	1,652
	5	12	17	1.6	3.9	10,800	3.2	18,000	5.3	19,400	5.7	706	1,197	1,652
	9	9	18	3.2	3.2	10,800	3.2	18,000	5.3	19,400	5.7	706	1,197	1,652
	7	12	19	2.5	3.9	10,800	3.2	18,000	5.3	19,400	5.7	706	1,197	1,652
	5	15	20	1.6	4.8	10,800	3.2	18,000	5.3	19,400	5.7	706	1,197	1,652
	9	12	21	3.2	3.9	10,800	3.2	18,000	5.3	19,400	5.7	706	1,197	1,652
	7	15	22	2.5	4.8	10,800	3.2	18,000	5.3	19,400	5.7	706	1,197	1,652
	9	15	24	3.2	4.8	10,800	3.2	18,000	5.3	19,400	5.7	706	1,197	1,652
		12	12	24	3.9	3.9	10,800	3.2	18,000	5.3	19,400	5.7	706	1,197

Примечание:

1. Производительность охлаждения указана для следующих условий: температура в помещении 27 °Сст / 19 °Свт; температура наружного воздуха 35 °Сст
2. Производительность нагрева указана для следующих условий: температура в помещении 20 °Сст; температура наружного воздуха 7 °Сст / 6 °Сст
3. Общая производительность подключенных внутренних блоков не должна превышать 24 кВт/ч

# MU3M19

Режим работы	Комбинации внутренних блоков (кВт/ч)				Охлаждение												
					Производительность (кВт)			Общая производительность						Потребляемая мощность (Вт)			
	БЛОК-А	БЛОК-В	БЛОК-С	Всего	Блок-А	Блок-В	БЛОК-С	Минимум		Номинал		Максимум		Минимум	Номинал	Максимум	
							Бте/ч	кВт	Бте/ч	кВт	Бте/ч	кВт	Бте/ч	кВт			
1 Блок	5	-	-	5	1.5	-	-	3,600	1.1	5,000	1.5	6,000	1.8	256	388	564	
	7	-	-	7	2.1	-	-	4,200	1.2	7,000	2.1	8,400	2.5	280	503	667	
	9	-	-	9	2.6	-	-	5,400	1.6	9,000	2.6	10,800	3.2	378	633	872	
	12	-	-	12	3.5	-	-	7,200	2.1	12,000	3.5	14,400	4.2	503	875	1,179	
	15	-	-	15	4.4	-	-	8,520	2.5	14,200	4.2	17,040	5.0	606	1,072	1,366	
	18	-	-	18	5.3	-	-	10,800	3.2	18,000	5.3	21,600	6.3	793	1,398	1,890	
2 Блока	5	5	-	10	1.5	1.5	-	6,000	1.8	10,000	2.9	12,000	3.5	406	676	914	
	5	7	-	12	1.5	2.1	-	7,200	2.1	12,000	3.5	14,400	4.2	478	831	1,120	
	5	9	-	14	1.5	2.6	-	8,400	2.5	14,000	4.1	16,800	4.9	576	991	1,335	
	7	7	-	14	2.1	2.1	-	8,400	2.5	14,000	4.1	16,800	4.9	576	991	1,335	
	7	9	-	16	2.1	2.6	-	9,600	2.8	16,000	4.7	19,200	5.6	651	1,157	1,573	
	5	12	-	17	1.5	3.5	-	10,200	3.0	17,000	5.0	20,400	6.0	702	1,242	1,720	
	9	9	-	18	2.6	2.6	-	10,800	3.2	18,000	5.3	21,600	6.3	753	1,328	1,842	
	7	12	-	19	2.1	3.5	-	10,800	3.2	18,000	5.3	21,600	6.3	753	1,328	1,842	
	5	15	-	20	1.5	4.4	-	10,800	3.2	18,000	5.3	21,600	6.3	753	1,328	1,842	
	9	12	-	21	2.6	3.5	-	10,800	3.2	18,000	5.3	21,600	6.3	753	1,328	1,842	
	7	15	-	22	2.1	4.4	-	10,800	3.2	18,000	5.3	21,600	6.3	753	1,328	1,842	
	9	15	-	24	2.6	4.4	-	10,800	3.2	18,000	5.3	21,600	6.3	753	1,328	1,842	
	12	12	-	24	3.5	3.5	-	10,800	3.2	18,000	5.3	21,600	6.3	753	1,328	1,842	
	9	18	-	27	2.6	5.3	-	10,800	3.2	18,000	5.3	21,600	6.3	753	1,328	1,842	
	12	15	-	27	3.5	4.4	-	10,800	3.2	18,000	5.3	21,600	6.3	753	1,328	1,842	
12	18	-	30	3.5	5.3	-	10,800	3.2	18,000	5.3	21,600	6.3	753	1,328	1,842		
15	15	-	30	4.4	4.4	-	10,800	3.2	18,000	5.3	21,600	6.3	753	1,328	1,842		
3 Блока	5	5	5	15	1.5	1.5	1.5	9,000	2.6	15,000	4.4	18,000	5.3	571	1,020	1,388	
	5	5	7	17	1.5	1.5	2.1	10,200	3.0	17,000	5.0	20,400	6.0	667	1,180	1,634	
	5	5	9	19	1.5	1.5	2.6	10,800	3.2	18,000	5.3	21,600	6.3	715	1,262	1,745	
	5	7	7	19	1.5	2.1	2.1	10,800	3.2	18,000	5.3	21,600	6.3	715	1,262	1,745	
	5	7	9	21	1.5	2.1	2.6	10,800	3.2	18,000	5.3	21,600	6.3	715	1,262	1,745	
	7	7	7	21	2.1	2.1	2.1	10,800	3.2	18,000	5.3	21,600	6.3	715	1,262	1,745	
	5	5	12	22	1.5	1.5	3.5	10,800	3.2	18,000	5.3	21,600	6.3	715	1,262	1,745	
	5	9	9	23	1.5	2.6	2.6	10,800	3.2	18,000	5.3	21,600	6.3	715	1,262	1,745	
	7	7	9	23	2.1	2.1	2.6	10,800	3.2	18,000	5.3	21,600	6.3	715	1,262	1,745	
	5	7	12	24	1.5	2.1	3.5	10,800	3.2	18,000	5.3	21,600	6.3	715	1,262	1,745	
	5	5	15	25	1.5	1.5	4.4	10,800	3.2	18,000	5.3	21,600	6.3	715	1,262	1,745	
	7	9	9	25	2.1	2.6	2.6	10,800	3.2	18,000	5.3	21,600	6.3	715	1,262	1,745	
	5	9	12	26	1.5	2.6	3.5	10,800	3.2	18,000	5.3	21,600	6.3	715	1,262	1,745	
	7	7	12	26	2.1	2.1	3.5	10,800	3.2	18,000	5.3	21,600	6.3	715	1,262	1,745	
	5	7	15	27	1.5	2.1	4.4	10,800	3.2	18,000	5.3	21,600	6.3	715	1,262	1,745	
	9	9	9	27	2.6	2.6	2.6	10,800	3.2	18,000	5.3	21,600	6.3	715	1,262	1,745	
	7	9	12	28	2.1	2.6	3.5	10,800	3.2	18,000	5.3	21,600	6.3	715	1,262	1,745	
	5	9	15	29	1.5	2.6	4.4	10,800	3.2	18,000	5.3	21,600	6.3	715	1,262	1,745	
	5	12	12	29	1.5	3.5	3.5	10,800	3.2	18,000	5.3	21,600	6.3	715	1,262	1,745	
	7	7	15	29	2.1	2.1	4.4	10,800	3.2	18,000	5.3	21,600	6.3	715	1,262	1,745	
9	9	12	30	2.6	2.6	3.5	10,800	3.2	18,000	5.3	21,600	6.3	715	1,262	1,745		

Примечание:

1. Производительность охлаждения указана для следующих условий: температура в помещении 27 °Сст / 19 °Сст; температура наружного воздуха 35 °Сст
2. Производительность нагрева указана для следующих условий: температура в помещении 20 °Сст; температура наружного воздуха 7 °Сст / 6 °Сст
3. Общая производительность подключенных внутренних блоков не должна превышать 30 кВт/ч

Режим работы	Комбинации внутренних блоков (кВт/ч)				Нагрев											
					Производительность (кВт)			Общая производительность						Потребляемая мощность (Вт)		
					Блок-А	Блок-В	БЛОК-С	Минимум		Номинал		Максимум		Минимум	Номинал	Максимум
Бте/ч	кВт	Бте/ч	кВт	Бте/ч				кВт								
1 Блок	БЛОК-А	БЛОК-В	БЛОК-С	Всего	Блок-А	Блок-В	БЛОК-С	Бте/ч	кВт	Бте/ч	кВт	Бте/ч	кВт	Минимум	Номинал	Максимум
	5	-	-	5	1.6	-	-	4,000	1.2	5,500	1.6	6,325	1.9	265	394	566
	7	-	-	7	2.5	-	-	5,040	1.5	8,400	2.5	9,660	2.8	335	575	715
	9	-	-	9	3.2	-	-	6,480	1.9	10,800	3.2	12,420	3.6	429	751	941
	12	-	-	12	3.9	-	-	7,920	2.3	13,200	3.9	15,180	4.4	526	935	1,178
	15	-	-	15	4.8	-	-	9,900	2.9	16,500	4.8	18,975	5.6	675	1,183	1,554
2 Блока	5	5	-	10	1.6	1.6	-	7,200	2.1	12,000	3.5	13,800	4.0	453	788	1,005
	5	7	-	12	1.6	2.5	-	8,640	2.5	14,400	4.2	16,560	4.9	546	965	1,265
	5	9	-	14	1.6	3.2	-	10,080	3.0	16,800	4.9	19,320	5.7	665	1,150	1,508
	7	7	-	14	2.5	2.5	-	10,080	3.0	16,800	4.9	19,320	5.7	665	1,150	1,508
	7	9	-	16	2.5	3.2	-	11,520	3.4	19,200	5.6	22,080	6.5	763	1,342	1,761
	5	12	-	17	1.6	3.9	-	12,240	3.6	20,400	6.0	23,460	6.9	813	1,456	1,892
	9	9	-	18	3.2	3.2	-	12,960	3.8	21,600	6.3	24,840	7.3	863	1,542	2,087
	7	12	-	19	2.5	3.9	-	12,960	3.8	21,600	6.3	24,840	7.3	863	1,542	2,087
	5	15	-	20	1.6	4.8	-	12,960	3.8	21,600	6.3	24,840	7.3	863	1,542	2,087
	9	12	-	21	3.2	3.9	-	12,960	3.8	21,600	6.3	24,840	7.3	863	1,542	2,087
	7	15	-	22	2.5	4.8	-	12,960	3.8	21,600	6.3	24,840	7.3	863	1,542	2,087
	9	15	-	24	3.2	4.8	-	12,960	3.8	21,600	6.3	24,840	7.3	863	1,542	2,087
	12	12	-	24	3.9	3.9	-	12,960	3.8	21,600	6.3	24,840	7.3	863	1,542	2,087
	9	18	-	27	3.2	5.8	-	12,960	3.8	21,600	6.3	24,840	7.3	863	1,542	2,087
	12	15	-	27	3.9	4.8	-	12,960	3.8	21,600	6.3	24,840	7.3	863	1,542	2,087
	12	18	-	30	3.9	5.8	-	12,960	3.8	21,600	6.3	24,840	7.3	863	1,542	2,087
	15	15	-	30	4.8	4.8	-	12,960	3.8	21,600	6.3	24,840	7.3	863	1,542	2,087
	3 Блока	5	5	5	15	1.6	1.6	1.6	10,800	3.2	18,000	5.3	20,700	6.1	678	1,196
5		5	7	17	1.6	1.6	2.5	12,240	3.6	20,400	6.0	23,460	6.9	772	1,383	1,797
5		5	9	19	1.6	1.6	3.2	12,960	3.8	21,600	6.3	24,840	7.3	820	1,465	2,001
5		7	7	19	1.6	2.5	2.5	12,960	3.8	21,600	6.3	24,840	7.3	820	1,465	2,001
5		7	9	21	1.6	2.5	3.2	12,960	3.8	21,600	6.3	24,840	7.3	820	1,465	2,001
7		7	7	21	2.5	2.5	2.5	12,960	3.8	21,600	6.3	24,840	7.3	820	1,465	2,001
5		5	12	22	1.6	1.6	3.9	12,960	3.8	21,600	6.3	24,840	7.3	820	1,465	2,001
5		9	9	23	1.6	3.2	3.2	12,960	3.8	21,600	6.3	24,840	7.3	820	1,465	2,001
7		7	9	23	2.5	2.5	3.2	12,960	3.8	21,600	6.3	24,840	7.3	820	1,465	2,001
5		7	12	24	1.6	2.5	3.9	12,960	3.8	21,600	6.3	24,840	7.3	820	1,465	2,001
5		5	15	25	1.6	1.6	4.8	12,960	3.8	21,600	6.3	24,840	7.3	820	1,465	2,001
7		9	9	25	2.5	3.2	3.2	12,960	3.8	21,600	6.3	24,840	7.3	820	1,465	2,001
5		9	12	26	1.6	3.2	3.9	12,960	3.8	21,600	6.3	24,840	7.3	820	1,465	2,001
7		7	12	26	2.5	2.5	3.9	12,960	3.8	21,600	6.3	24,840	7.3	820	1,465	2,001
5		7	15	27	1.6	2.5	4.8	12,960	3.8	21,600	6.3	24,840	7.3	820	1,465	2,001
9		9	9	27	3.2	3.2	3.2	12,960	3.8	21,600	6.3	24,840	7.3	820	1,465	2,001
7		9	12	28	2.5	3.2	3.9	12,960	3.8	21,600	6.3	24,840	7.3	820	1,465	2,001
5		9	15	29	1.6	3.2	4.8	12,960	3.8	21,600	6.3	24,840	7.3	820	1,465	2,001
5		12	12	29	1.6	3.9	3.9	12,960	3.8	21,600	6.3	24,840	7.3	820	1,465	2,001
7		7	15	29	2.5	2.5	4.8	12,960	3.8	21,600	6.3	24,840	7.3	820	1,465	2,001
9		9	12	30	3.2	3.2	3.9	12,960	3.8	21,600	6.3	24,840	7.3	820	1,465	2,001

Примечание:

1. Производительность охлаждения указана для следующих условий: температура в помещении 27 °Сст / 19 °Сст; температура наружного воздуха 35 °Сст
2. Производительность нагрева указана для следующих условий: температура в помещении 20 °Сст; температура наружного воздуха 7 °Сст / 6 °Сст
3. Общая производительность подключенных внутренних блоков не должна превышать 30 кВт/ч

# MU3M21

Режим работы	Комбинации внутренних блоков (кВт/ч)				Охлаждение												
					Производительность (кВт)			Общая производительность						Потребляемая мощность (Вт)			
	БЛОК А	БЛОК В	БЛОК С	Всего	БЛОК А	БЛОК В	БЛОК С	Минимум		Номинал		Максимум		Минимум	Номинал	Максимум	
							Бте/ч	кВт	Бте/ч	кВт	Бте/ч	кВт	Бте/ч	кВт			
1 Блок	5	-	-	5	1.5	-	-	3,600	1.1	5,000	1.5	6,000	1.8	256	388	564	
	7	-	-	7	2.1	-	-	4,200	1.2	7,000	2.1	8,400	2.5	280	503	667	
	9	-	-	9	2.6	-	-	5,400	1.6	9,000	2.6	10,800	3.2	378	633	872	
	12	-	-	12	3.5	-	-	7,200	2.1	12,000	3.5	14,400	4.2	503	875	1,179	
	15	-	-	15	4.4	-	-	8,520	2.5	14,200	4.2	17,040	5.0	606	1,072	1,366	
	18	-	-	18	5.3	-	-	10,800	3.2	18,000	5.3	21,600	6.3	793	1,398	1,890	
2 Блока	5	5	-	10	1.5	1.5	-	6,000	1.8	10,000	2.9	12,000	3.5	406	676	914	
	5	7	-	12	1.5	2.1	-	7,200	2.1	12,000	3.5	14,400	4.2	478	831	1,120	
	5	9	-	14	1.5	2.6	-	8,400	2.5	14,000	4.1	16,800	4.9	576	991	1,335	
	7	7	-	14	2.1	2.1	-	8,400	2.5	14,000	4.1	16,800	4.9	576	991	1,335	
	7	9	-	16	2.1	2.6	-	9,600	2.8	16,000	4.7	19,200	5.6	651	1,157	1,573	
	5	12	-	17	1.5	3.5	-	10,200	3.0	17,000	5.0	20,400	6.0	702	1,242	1,720	
	9	9	-	18	2.6	2.6	-	10,800	3.2	18,000	5.3	21,600	6.3	753	1,328	1,842	
	7	12	-	19	2.1	3.5	-	11,400	3.3	19,000	5.6	22,800	6.7	779	1,430	2,039	
	5	15	-	20	1.5	4.4	-	12,000	3.5	20,000	5.9	23,100	6.8	831	1,530	2,091	
	9	12	-	21	2.6	3.5	-	12,600	3.7	21,000	6.2	23,100	6.8	884	1,632	2,091	
	7	15	-	22	2.1	4.4	-	12,600	3.7	21,000	6.2	23,100	6.8	884	1,632	2,091	
	5	18	-	23	1.5	5.3	-	12,600	3.7	21,000	6.2	23,100	6.8	884	1,632	2,091	
	9	15	-	24	2.6	4.4	-	12,600	3.7	21,000	6.2	23,100	6.8	884	1,632	2,091	
	12	12	-	24	3.5	3.5	-	12,600	3.7	21,000	6.2	23,100	6.8	884	1,632	2,091	
	9	18	-	27	2.6	5.3	-	12,600	3.7	21,000	6.2	23,100	6.8	884	1,632	2,091	
3 Блока	12	15	-	27	3.5	4.4	-	12,600	3.7	21,000	6.2	23,100	6.8	884	1,632	2,091	
	12	18	-	30	3.5	5.3	-	12,600	3.7	21,000	6.2	23,100	6.8	884	1,632	2,091	
	15	15	-	30	4.4	4.4	-	12,600	3.7	21,000	6.2	23,100	6.8	884	1,632	2,091	
	15	18	-	33	4.4	5.3	-	12,600	3.7	21,000	6.2	23,100	6.8	884	1,632	2,091	
	5	5	5	15	1.5	1.5	1.5	9,000	2.6	15,000	4.4	18,000	5.3	571	1,020	1,388	
	5	5	7	17	1.5	1.5	2.1	10,200	3.0	17,000	5.0	20,400	6.0	667	1,180	1,634	
	5	5	9	19	1.5	1.5	2.6	11,400	3.3	19,000	5.6	22,800	6.7	740	1,359	1,908	
	5	7	7	19	1.5	2.1	2.1	11,400	3.3	19,000	5.6	22,800	6.7	740	1,359	1,908	
	5	7	9	21	1.5	2.1	2.6	12,600	3.7	21,000	6.2	25,000	7.3	840	1,550	2,169	
	7	7	7	21	2.1	2.1	2.1	12,600	3.7	21,000	6.2	25,000	7.3	840	1,550	2,169	
	5	5	12	22	1.5	1.5	3.5	12,600	3.7	21,000	6.2	25,000	7.3	840	1,550	2,169	
	5	9	9	23	1.5	2.6	2.6	12,600	3.7	21,000	6.2	25,000	7.3	840	1,550	2,169	
	7	7	9	23	2.1	2.1	2.6	12,600	3.7	21,000	6.2	25,000	7.3	840	1,550	2,169	
	5	7	12	24	1.5	2.1	3.5	12,600	3.7	21,000	6.2	25,000	7.3	840	1,550	2,169	
	5	5	15	25	1.5	1.5	4.4	12,600	3.7	21,000	6.2	25,000	7.3	840	1,550	2,169	
7	9	9	25	2.1	2.6	2.6	12,600	3.7	21,000	6.2	25,000	7.3	840	1,550	2,169		
5	9	12	26	1.5	2.6	3.5	12,600	3.7	21,000	6.2	25,000	7.3	840	1,550	2,169		
7	7	12	26	2.1	2.1	3.5	12,600	3.7	21,000	6.2	25,000	7.3	840	1,550	2,169		
5	7	15	27	1.5	2.1	4.4	12,600	3.7	21,000	6.2	25,000	7.3	840	1,550	2,169		
9	9	9	27	2.6	2.6	2.6	12,600	3.7	21,000	6.2	25,000	7.3	840	1,550	2,169		
7	9	12	28	2.1	2.6	3.5	12,600	3.7	21,000	6.2	25,000	7.3	840	1,550	2,169		
5	9	15	29	1.5	2.6	4.4	12,600	3.7	21,000	6.2	25,000	7.3	840	1,550	2,169		
5	12	12	29	1.5	3.5	3.5	12,600	3.7	21,000	6.2	25,000	7.3	840	1,550	2,169		
7	7	15	29	2.1	2.1	4.4	12,600	3.7	21,000	6.2	25,000	7.3	840	1,550	2,169		
9	9	12	30	2.6	2.6	3.5	12,600	3.7	21,000	6.2	25,000	7.3	840	1,550	2,169		
7	9	15	31	2.1	2.6	4.4	12,600	3.7	21,000	6.2	25,000	7.3	840	1,550	2,169		
7	12	12	31	2.1	3.5	3.5	12,600	3.7	21,000	6.2	25,000	7.3	840	1,550	2,169		
5	12	15	32	1.5	3.5	4.4	12,600	3.7	21,000	6.2	25,000	7.3	840	1,550	2,169		
5	9	18	32	1.5	2.6	5.3	12,600	3.7	21,000	6.2	25,000	7.3	840	1,550	2,169		
7	7	18	32	2.1	2.1	5.3	12,600	3.7	21,000	6.2	25,000	7.3	840	1,550	2,169		
9	9	15	33	2.6	2.6	4.4	12,600	3.7	21,000	6.2	25,000	7.3	840	1,550	2,169		
9	12	12	33	2.6	3.5	3.5	12,600	3.7	21,000	6.2	25,000	7.3	840	1,550	2,169		

Примечание:

1. Производительность охлаждения указана для следующих условий: температура в помещении 27 °Сст / 19 °Сст; температура наружного воздуха 35 °Сст
2. Производительность нагрева указана для следующих условий: температура в помещении 20 °Сст; температура наружного воздуха 7 °Сст / 6 °Сст
3. Общая производительность подключенных внутренних блоков не должна превышать 33 кВт/ч

Режим работы	Комбинации внутренних блоков (кВт/ч)				Нагрев											
					Производительность (кВт)			Общая производительность								
	БЛОК А	БЛОК В	БЛОК С	Всего	БЛОК А	БЛОК В	БЛОК С	Минимум		Номинал		Максимум		Минимум	Номинал	Максимум
Бте/ч								кВт	Бте/ч	кВт	Бте/ч	кВт				
1 Блок	5	-	-	5	1.6	-	-	4,000	1.2	5,500	1.6	6,325	1.9	265	394	566
	7	-	-	7	2.5	-	-	5,040	1.5	8,400	2.5	9,660	2.8	335	575	715
	9	-	-	9	3.2	-	-	6,480	1.9	10,800	3.2	12,420	3.6	429	751	941
	12	-	-	12	3.9	-	-	7,920	2.3	13,200	3.9	15,180	4.4	526	935	1,178
	15	-	-	15	4.8	-	-	9,900	2.9	16,500	4.8	18,975	5.6	675	1,183	1,554
	18	-	-	18	5.8	-	-	11,880	3.5	19,800	5.8	22,770	6.7	829	1,472	1,922
2 Блока	5	5	-	10	1.6	1.6	-	7,200	2.1	12,000	3.5	13,800	4.0	453	788	1,005
	5	7	-	12	1.6	2.5	-	8,640	2.5	14,400	4.2	16,560	4.9	546	965	1,265
	5	9	-	14	1.6	3.2	-	10,080	3.0	16,800	4.9	19,320	5.7	665	1,150	1,508
	7	7	-	14	2.5	2.5	-	10,080	3.0	16,800	4.9	19,320	5.7	665	1,150	1,508
	7	9	-	16	2.5	3.2	-	11,520	3.4	19,200	5.6	22,080	6.5	763	1,342	1,761
	5	12	-	17	1.6	3.9	-	12,240	3.6	20,400	6.0	23,460	6.9	813	1,399	1,892
	9	9	-	18	3.2	3.2	-	12,960	3.8	21,600	6.3	24,840	7.3	863	1,484	2,087
	7	12	-	19	2.5	3.9	-	13,320	3.9	22,200	6.5	25,530	7.5	888	1,542	2,196
	5	15	-	20	1.6	4.8	-	13,740	4.0	22,900	6.7	26,335	7.7	914	1,601	2,310
	9	12	-	21	3.2	3.9	-	14,400	4.2	24,000	7.0	26,500	7.8	965	1,690	2,368
	7	15	-	22	2.5	4.8	-	14,400	4.2	24,000	7.0	26,500	7.8	965	1,690	2,368
	5	18	-	23	3.2	4.8	-	14,400	4.2	24,000	7.0	26,500	7.8	965	1,690	2,368
	9	15	-	24	3.9	3.9	-	14,400	4.2	24,000	7.0	26,500	7.8	965	1,690	2,368
	12	12	-	24	3.2	5.8	-	14,400	4.2	24,000	7.0	26,500	7.8	965	1,690	2,368
	9	18	-	27	3.9	4.8	-	14,400	4.2	24,000	7.0	26,500	7.8	965	1,690	2,368
12	15	-	27	3.9	5.8	-	14,400	4.2	24,000	7.0	26,500	7.8	965	1,690	2,368	
12	18	-	30	4.8	4.8	-	14,400	4.2	24,000	7.0	26,500	7.8	965	1,690	2,368	
15	15	-	30	4.8	4.8	-	14,400	4.2	24,000	7.0	26,500	7.8	965	1,690	2,368	
15	18	-	33	4.8	5.8	-	14,400	4.2	24,000	7.0	26,500	7.8	965	1,690	2,368	
3 Блока	5	5	5	15	1.6	1.6	1.6	10,080	3.2	18,000	5.3	20,700	6.1	678	1,196	1,551
	5	5	7	17	1.6	1.6	2.5	12,240	3.6	20,400	6.0	23,460	6.9	772	1,383	1,797
	5	5	9	19	1.6	1.6	3.2	13,320	3.9	22,200	6.5	25,530	7.5	844	1,521	2,118
	5	7	7	19	1.6	2.5	2.5	13,320	3.9	22,200	6.5	25,530	7.5	844	1,521	2,118
	5	7	9	21	1.6	2.5	3.2	14,400	4.2	24,000	7.0	26,500	7.8	917	1,667	2,305
	7	7	7	21	2.5	2.5	2.5	14,400	4.2	24,000	7.0	26,500	7.8	917	1,667	2,305
	5	5	12	22	1.6	1.6	3.9	14,400	4.2	24,000	7.0	26,500	7.8	917	1,667	2,305
	5	9	9	23	1.6	3.2	3.2	14,400	4.2	24,000	7.0	26,500	7.8	917	1,667	2,305
	7	7	9	23	2.5	2.5	3.2	14,400	4.2	24,000	7.0	26,500	7.8	917	1,667	2,305
	5	7	12	24	1.6	2.5	3.9	14,400	4.2	24,000	7.0	26,500	7.8	917	1,667	2,305
	5	5	15	25	1.6	1.6	4.8	14,400	4.2	24,000	7.0	26,500	7.8	917	1,667	2,305
	7	9	9	25	2.5	3.2	3.2	14,400	4.2	24,000	7.0	26,500	7.8	917	1,667	2,305
	5	9	12	26	1.6	3.2	3.9	14,400	4.2	24,000	7.0	26,500	7.8	917	1,667	2,305
	7	7	12	26	2.5	2.5	3.9	14,400	4.2	24,000	7.0	26,500	7.8	917	1,667	2,305
	5	7	15	27	1.6	2.5	4.8	14,400	4.2	24,000	7.0	26,500	7.8	917	1,667	2,305
	9	9	9	27	3.2	3.2	3.2	14,400	4.2	24,000	7.0	26,500	7.8	917	1,667	2,305
	7	9	12	28	2.5	3.2	3.9	14,400	4.2	24,000	7.0	26,500	7.8	917	1,667	2,305
	5	9	15	29	1.6	3.2	4.8	14,400	4.2	24,000	7.0	26,500	7.8	917	1,667	2,305
	5	12	12	29	1.6	3.9	3.9	14,400	4.2	24,000	7.0	26,500	7.8	917	1,667	2,305
	7	7	15	29	2.5	2.5	4.8	14,400	4.2	24,000	7.0	26,500	7.8	917	1,667	2,305
	9	9	12	30	3.2	3.2	3.9	14,400	4.2	24,000	7.0	26,500	7.8	917	1,667	2,305
	7	9	15	31	2.5	3.2	4.8	14,400	4.2	24,000	7.0	26,500	7.8	917	1,667	2,305
	7	12	12	31	2.5	3.9	3.9	14,400	4.2	24,000	7.0	26,500	7.8	917	1,667	2,305
	5	12	15	32	1.6	3.9	4.8	14,400	4.2	24,000	7.0	26,500	7.8	917	1,667	2,305
5	9	18	32	1.6	3.2	5.8	14,400	4.2	24,000	7.0	26,500	7.8	917	1,667	2,305	
7	7	18	32	2.5	2.5	5.8	14,400	4.2	24,000	7.0	26,500	7.8	917	1,667	2,305	
9	9	15	33	3.2	3.2	4.8	14,400	4.2	24,000	7.0	26,500	7.8	917	1,667	2,305	
9	12	12	33	3.2	3.9	3.9	14,400	4.2	24,000	7.0	26,500	7.8	917	1,667	2,305	

Примечание:

1. Производительность охлаждения указана для следующих условий: температура в помещении 27 °Сст / 19 °Свт; температура наружного воздуха 35 °Сст
2. Производительность нагрева указана для следующих условий: температура в помещении 20 °Сст; температура наружного воздуха 7 °Сст / 6 °Свт
3. Общая производительность подключенных внутренних блоков не должна превышать 33 кВт/ч



# MU4M25

Режим работы	Комбинации внутренних блоков (кВт/ч)					Охлаждение												
						Производительность (кВт)				Общая производительность						Потребляемая мощность (Вт)		
						БЛОК А	БЛОК В	БЛОК С	БЛОК D	Всего	Минимум		Номинал		Максимум		Минимум	Номинал
БТЕ/ч	кВт	БТЕ/ч	кВт	БТЕ/ч	кВт													
1 Блок	БЛОК А	БЛОК В	БЛОК С	БЛОК D	Всего	БЛОК А	БЛОК В	БЛОК С	БЛОК D	БТЕ/ч	кВт	БТЕ/ч	кВт	БТЕ/ч	кВт	Минимум	Номинал	Максимум
	5	-	-	-	5	1.5	-	-	-	4,500	1.3	5,000	1.5	6,000	1.8	416	467	684
	7	-	-	-	7	2.1	-	-	-	4,800	1.4	7,000	2.1	8,400	2.5	416	551	741
	9	-	-	-	9	2.6	-	-	-	5,400	1.6	9,000	2.6	10,800	3.2	416	689	961
	12	-	-	-	12	3.5	-	-	-	7,200	2.1	12,000	3.5	14,400	4.2	551	944	1,287
	15	-	-	-	15	4.4	-	-	-	8,520	2.5	14,200	4.2	17,040	5.0	661	1,149	1,557
2 Блок	18	-	-	-	18	5.3	-	-	-	10,800	3.2	18,000	5.3	21,600	6.3	858	1,482	2,013
	24	-	-	-	24	7.0	-	-	-	14,400	4.2	24,000	7.0	25,500	7.5	1,149	2,026	2,830
	5	5	-	-	10	1.5	1.5	-	-	6,000	1.8	10,000	2.9	12,000	3.5	423	696	952
	5	7	-	-	12	1.5	2.1	-	-	7,200	2.1	12,000	3.5	14,400	4.2	496	850	1,158
	5	9	-	-	14	1.5	2.6	-	-	8,400	2.5	14,000	4.1	16,800	4.9	595	1,034	1,370
	7	7	-	-	14	2.1	2.1	-	-	8,400	2.5	14,000	4.1	16,800	4.9	595	1,034	1,370
	7	9	-	-	16	2.1	2.6	-	-	9,600	2.8	16,000	4.7	19,200	5.6	670	1,196	1,588
	5	12	-	-	17	1.5	3.5	-	-	10,200	3.0	17,000	5.0	20,400	6.0	721	1,279	1,715
	9	9	-	-	18	2.6	2.6	-	-	10,800	3.2	18,000	5.3	21,600	6.3	772	1,362	1,812
	7	12	-	-	19	2.1	3.5	-	-	11,400	3.3	19,000	5.6	22,800	6.7	798	1,446	1,943
	5	15	-	-	20	1.5	4.4	-	-	12,000	3.5	20,000	5.9	24,000	7.0	850	1,532	2,042
	9	12	-	-	21	2.6	3.5	-	-	12,600	3.7	21,000	6.2	24,150	7.1	902	1,618	2,089
	7	15	-	-	22	2.1	4.4	-	-	13,200	3.9	22,000	6.4	25,300	7.4	955	1,676	2,230
	5	18	-	-	23	1.5	5.3	-	-	13,800	4.0	23,000	6.7	26,450	7.8	981	1,764	2,426
	9	15	-	-	24	2.6	4.4	-	-	14,400	4.2	24,000	7.0	28,800	8.4	1,034	1,865	2,756
	12	12	-	-	24	3.5	3.5	-	-	14,400	4.2	24,000	7.0	28,800	8.4	1,034	1,865	2,756
	7	18	-	-	25	2.1	5.3	-	-	14,400	4.2	24,000	7.0	28,800	8.4	1,034	1,865	2,756
	9	18	-	-	27	2.6	5.3	-	-	14,400	4.2	24,000	7.0	28,800	8.4	1,034	1,865	2,756
	12	15	-	-	27	3.5	4.4	-	-	14,400	4.2	24,000	7.0	28,800	8.4	1,034	1,865	2,756
	5	24	-	-	29	1.5	7.0	-	-	14,400	4.2	24,000	7.0	28,800	8.4	1,034	1,865	2,756
	12	18	-	-	30	3.5	5.3	-	-	14,400	4.2	24,000	7.0	28,800	8.4	1,034	1,865	2,756
	15	15	-	-	30	4.4	4.4	-	-	14,400	4.2	24,000	7.0	29,000	8.5	1,034	1,865	2,814
	7	24	-	-	31	2.1	7.0	-	-	14,400	4.2	24,000	7.0	29,000	8.5	1,034	1,865	2,814
	9	24	-	-	33	2.6	7.0	-	-	14,400	4.2	24,000	7.0	29,000	8.5	1,034	1,865	2,814
15	18	-	-	33	4.4	5.3	-	-	14,400	4.2	24,000	7.0	29,000	8.5	1,034	1,865	2,814	
18	18	-	-	36	5.3	5.3	-	-	14,400	4.2	24,000	7.0	29,000	8.5	1,034	1,865	2,814	
12	24	-	-	36	3.5	7.0	-	-	14,400	4.2	24,000	7.0	29,000	8.5	1,034	1,865	2,814	
3 Блок	5	5	5	-	15	1.5	1.5	1.5	-	9,000	2.6	15,000	4.4	18,000	5.3	583	1,023	1,405
	5	5	7	-	17	1.5	1.5	2.1	-	10,200	3.0	17,000	5.0	20,400	6.0	678	1,176	1,613
	5	5	9	-	19	1.5	1.5	2.6	-	11,400	3.3	19,000	5.6	22,800	6.7	750	1,333	1,826
	5	7	7	-	19	1.5	2.1	2.1	-	11,400	3.3	19,000	5.6	22,800	6.7	750	1,333	1,826
	5	7	9	-	21	1.5	2.1	2.6	-	12,600	3.7	21,000	6.2	25,200	7.4	848	1,494	2,096
	7	7	7	-	21	2.1	2.1	2.1	-	12,600	3.7	21,000	6.2	25,200	7.4	848	1,494	2,096
	5	5	12	-	22	1.5	1.5	3.5	-	13,200	3.9	22,000	6.4	26,400	7.7	897	1,548	2,234
	5	9	9	-	23	1.5	2.6	2.6	-	13,800	4.0	23,000	6.7	27,600	8.1	922	1,630	2,441
	7	7	9	-	23	2.1	2.1	2.6	-	13,800	4.0	23,000	6.7	27,600	8.1	922	1,630	2,441
	5	7	12	-	24	1.5	2.1	3.5	-	14,400	4.2	24,000	7.0	28,800	8.4	972	1,714	2,617
	5	5	15	-	25	1.5	1.5	4.4	-	14,400	4.2	24,000	7.0	28,800	8.4	972	1,714	2,617
	7	9	9	-	25	2.1	2.6	2.6	-	14,400	4.2	24,000	7.0	28,800	8.4	972	1,714	2,617
	5	9	12	-	26	1.5	2.6	3.5	-	14,400	4.2	24,000	7.0	28,800	8.4	972	1,714	2,617
	7	7	12	-	26	2.1	2.1	3.5	-	14,400	4.2	24,000	7.0	28,800	8.4	972	1,714	2,617
	5	7	15	-	27	1.5	2.1	4.4	-	14,400	4.2	24,000	7.0	28,800	8.4	972	1,714	2,617
	9	9	9	-	27	2.6	2.6	2.6	-	14,400	4.2	24,000	7.0	28,800	8.4	972	1,714	2,617
	7	9	12	-	28	2.1	2.6	3.5	-	14,400	4.2	24,000	7.0	28,800	8.4	972	1,714	2,617
	5	5	18	-	28	1.5	1.5	5.3	-	14,400	4.2	24,000	7.0	28,800	8.4	972	1,714	2,617
	5	9	15	-	29	1.5	2.6	4.4	-	14,400	4.2	24,000	7.0	28,800	8.4	972	1,714	2,617
	5	12	12	-	29	1.5	3.5	3.5	-	14,400	4.2	24,000	7.0	28,800	8.4	972	1,714	2,617
	7	7	15	-	29	2.1	2.1	4.4	-	14,400	4.2	24,000	7.0	28,800	8.4	972	1,714	2,617
	5	7	18	-	30	1.5	2.1	5.3	-	14,400	4.2	24,000	7.0	28,800	8.4	972	1,714	2,617
	9	9	12	-	30	2.6	2.6	3.5	-	14,400	4.2	24,000	7.0	28,800	8.4	972	1,714	2,617
	7	9	15	-	31	2.1	2.6	4.4	-	14,400	4.2	24,000	7.0	29,000	8.5	972	1,714	2,677
	7	12	12	-	31	2.1	3.5	3.5	-	14,400	4.2	24,000	7.0	29,000	8.5	972	1,714	2,677
	5	12	15	-	32	1.5	3.5	4.4	-	14,400	4.2	24,000	7.0	29,000	8.5	972	1,714	2,677
	5	9	18	-	32	1.5	2.6	5.3	-	14,400	4.2	24,000	7.0	29,000	8.5	972	1,714	2,677
	7	7	18	-	32	2.1	2.1	5.3	-	14,400	4.2	24,000	7.0	29,000	8.5	972	1,714	2,677
	9	9	15	-	33	2.6	2.6	4.4	-	14,400	4.2	24,000	7.0	29,000	8.5	972	1,714	2,677
	9	12	12	-	33	2.6	3.5	3.5	-	14,400	4.2	24,000	7.0	29,000	8.5	972	1,714	2,677
	7	9	18	-	34	2.1	2.6	5.3	-	14,400	4.2	24,000	7.0	29,000	8.5	972	1,714	2,677
	7	12	15	-	34	2.1	3.5	4.4	-	14,400	4.2	24,000	7.0	29,000	8.5	972	1,714	2,677
	5	5	24	-	34	1.5	1.5	7.0	-	14,400	4.2	24,000	7.0	29,000	8.5	972	1,714	2,677
	5	12	18	-	35	1.5	3.5	5.3	-	14,400	4.2	24,000	7.0	29,000	8.5	972	1,714	2,677
	5	15	15	-	35	1.5	4.4	4.4	-	14,400	4.2	24,000	7.0	29,000	8.5	972	1,714	2,677
	5	7	24	-	36	1.5	2.1	7.0	-	14,400	4.2	24,000	7.0	29,000	8.5	972	1,714	2,677
	9	12	15	-	36	2.6	3.5	4.4	-	14,400	4.2	24,000	7.0	29,000	8.5	972	1,714	2,677
	12	12	12	-	36	3.5	3.5	3.5	-	14,400	4.2	24,000	7.0	29,000	8.5	972	1,714	2,677
	9	9	18	-	36													

Режим работы	Комбинации внутренних блоков (кВт/ч)					Охлаждение												
						Производительность (кВт)				Общая производительность						Потребляемая мощность (Вт)		
	БЛОК А	БЛОК В	БЛОК С	БЛОК D	Всего	БЛОК А	БЛОК В	БЛОК С	БЛОК D	Минимум		Номинал		Максимум		Минимум	Номинал	Максимум
БТЕ/ч										кВт	БТЕ/ч	кВт	БТЕ/ч	кВт				
1 Блок	5	5	5	5	20	1.5	1.5	1.5	1.5	12,000	3.5	20,000	5.9	24,000	7.0	759	1,342	1,823
4 Блока	5	5	5	7	22	1.5	1.5	1.5	2.1	13,200	3.9	22,000	6.4	26,400	7.7	853	1,471	2,122
	5	5	5	9	24	1.5	1.5	1.5	2.6	14,400	4.2	24,000	7.0	28,800	8.4	924	1,628	2,436
	5	5	7	7	24	1.5	1.5	2.1	2.1	14,400	4.2	24,000	7.0	28,800	8.4	924	1,628	2,436
	5	5	7	9	26	1.5	1.5	2.1	2.6	14,400	4.2	24,000	7.0	28,800	8.4	924	1,628	2,436
	5	7	7	7	26	1.5	2.1	2.1	2.1	14,400	4.2	24,000	7.0	28,800	8.4	924	1,628	2,436
	5	5	5	12	27	1.5	1.5	1.5	3.5	14,400	4.2	24,000	7.0	28,800	8.4	924	1,628	2,436
	5	5	9	9	28	1.5	1.5	2.6	2.6	14,400	4.2	24,000	7.0	28,800	8.4	924	1,628	2,436
	5	7	7	9	28	1.5	2.1	2.1	2.6	14,400	4.2	24,000	7.0	28,800	8.4	924	1,628	2,436
	7	7	7	7	28	2.1	2.1	2.1	2.1	14,400	4.2	24,000	7.0	28,800	8.4	924	1,628	2,436
	5	5	7	12	29	1.5	1.5	2.1	3.5	14,400	4.2	24,000	7.0	28,800	8.4	924	1,628	2,436
	5	5	5	15	30	1.5	1.5	1.5	4.4	14,400	4.2	24,000	7.0	29,000	8.5	924	1,628	2,482
	5	7	9	9	30	1.5	2.1	2.6	2.6	14,400	4.2	24,000	7.0	29,000	8.5	924	1,628	2,482
	7	7	7	9	30	2.1	2.1	2.1	2.6	14,400	4.2	24,000	7.0	29,000	8.5	924	1,628	2,482
	5	5	9	12	31	1.5	1.5	2.6	3.5	14,400	4.2	24,000	7.0	29,000	8.5	924	1,628	2,482
	5	7	7	12	31	1.5	2.1	2.1	3.5	14,400	4.2	24,000	7.0	29,000	8.5	924	1,628	2,482
	5	5	7	15	32	1.5	1.5	2.1	4.4	14,400	4.2	24,000	7.0	29,000	8.5	924	1,628	2,482
	7	7	9	9	32	2.1	2.1	2.6	2.6	14,400	4.2	24,000	7.0	29,000	8.5	924	1,628	2,482
	5	9	9	9	32	1.5	2.6	2.6	2.6	14,400	4.2	24,000	7.0	29,000	8.5	924	1,628	2,482
	5	5	5	18	33	1.5	1.5	1.5	5.3	14,400	4.2	24,000	7.0	29,000	8.5	924	1,628	2,482
	5	7	9	12	33	1.5	2.1	2.6	3.5	14,400	4.2	24,000	7.0	29,000	8.5	924	1,628	2,482
	7	7	7	12	33	2.1	2.1	2.1	3.5	14,400	4.2	24,000	7.0	29,000	8.5	924	1,628	2,482
	5	5	9	15	34	1.5	1.5	2.6	4.4	14,400	4.2	24,000	7.0	29,000	8.5	924	1,628	2,482
	5	5	12	12	34	1.5	1.5	3.5	3.5	14,400	4.2	24,000	7.0	29,000	8.5	924	1,628	2,482
	5	7	7	15	34	1.5	2.1	2.1	4.4	14,400	4.2	24,000	7.0	29,000	8.5	924	1,628	2,482
	7	9	9	9	34	2.1	2.6	2.6	2.6	14,400	4.2	24,000	7.0	29,000	8.5	924	1,628	2,482
	5	5	7	18	35	1.5	1.5	2.1	5.3	14,400	4.2	24,000	7.0	29,000	8.5	924	1,628	2,482
	5	9	9	12	35	1.5	2.6	2.6	3.5	14,400	4.2	24,000	7.0	29,000	8.5	924	1,628	2,482
	7	7	9	12	35	2.1	2.1	2.6	3.5	14,400	4.2	24,000	7.0	29,000	8.5	924	1,628	2,482
	5	7	9	15	36	1.5	2.1	2.6	4.4	14,400	4.2	24,000	7.0	29,000	8.5	924	1,628	2,482
	5	7	12	12	36	1.5	2.1	3.5	3.5	14,400	4.2	24,000	7.0	29,000	8.5	924	1,628	2,482
	7	7	7	15	36	2.1	2.1	2.1	4.4	14,400	4.2	24,000	7.0	29,000	8.5	924	1,628	2,482
	9	9	9	9	36	2.6	2.6	2.6	2.6	14,400	4.2	24,000	7.0	29,000	8.5	924	1,628	2,482
5	5	9	18	37	1.5	1.5	2.6	5.3	14,400	4.2	24,000	7.0	29,000	8.5	924	1,628	2,482	
5	5	12	15	37	1.5	1.5	3.5	4.4	14,400	4.2	24,000	7.0	29,000	8.5	924	1,628	2,482	
5	7	7	18	37	1.5	2.1	2.1	5.3	14,400	4.2	24,000	7.0	29,000	8.5	924	1,628	2,482	
7	9	9	12	37	2.1	2.6	2.6	3.5	14,400	4.2	24,000	7.0	29,000	8.5	924	1,628	2,482	
5	9	9	15	38	1.5	2.6	2.6	4.4	14,400	4.2	24,000	7.0	29,000	8.5	924	1,628	2,482	
7	7	9	15	38	2.1	2.1	2.6	4.4	14,400	4.2	24,000	7.0	29,000	8.5	924	1,628	2,482	
7	7	12	12	38	2.1	2.1	3.5	3.5	14,400	4.2	24,000	7.0	29,000	8.5	924	1,628	2,482	
5	5	5	24	39	1.5	1.5	1.5	7.0	14,400	4.2	24,000	7.0	29,000	8.5	924	1,628	2,482	
5	7	9	18	39	1.5	2.1	2.6	5.3	14,400	4.2	24,000	7.0	29,000	8.5	924	1,628	2,482	
5	7	12	15	39	1.5	2.1	3.5	4.4	14,400	4.2	24,000	7.0	29,000	8.5	924	1,628	2,482	
9	9	9	12	39	2.6	2.6	2.6	3.5	14,400	4.2	24,000	7.0	29,000	8.5	924	1,628	2,482	
7	7	7	18	39	2.1	2.1	2.1	5.3	14,400	4.2	24,000	7.0	29,000	8.5	924	1,628	2,482	

Примечание:

1. Производительность охлаждения указана для следующих условий: температура в помещении 27 °Сст / 19 °Свт; температура наружного воздуха 35 °Сст
2. Производительность нагрева указана для следующих условий: температура в помещении 20 °Сст; температура наружного воздуха 7 °Сст / 6 °Сст
3. Общая производительность подключенных внутренних блоков не должна превышать 39 кВт/ч

# MU4M25

Режим работы	Комбинации внутренних блоков (кВт/ч)					Нагрев												
						Производительность (кВт)				Общая производительность						Потребляемая мощность (Вт)		
						БЛОК А	БЛОК В	БЛОК С	БЛОК D	Всего	БЛОК А	БЛОК В	БЛОК С	БЛОК D	Бте/ч	кВт	Бте/ч	кВт
1 Блок	5	-	-	-	5	1.6	-	-	-	5,000	1.5	5,500	1.6	6,325	1.9	610	610	747
	7	-	-	-	7	2.5	-	-	-	5,500	1.6	8,400	2.5	9,660	2.8	610	665	862
	9	-	-	-	9	3.2	-	-	-	6,480	1.9	10,800	3.2	12,420	3.6	610	864	1,126
	12	-	-	-	12	3.9	-	-	-	7,920	2.3	13,200	3.9	15,180	4.4	610	1,067	1,399
	15	-	-	-	15	4.8	-	-	-	9,900	2.9	16,500	4.8	18,975	5.6	778	1,337	1,823
	18	-	-	-	18	5.8	-	-	-	11,880	3.5	19,800	5.8	22,770	6.7	950	1,649	2,230
	24	-	-	-	24	7.4	-	-	-	15,240	4.5	25,400	7.4	26,670	7.8	1,246	2,172	2,654
2 Блока	5	5	-	-	10	1.6	1.6	-	-	7,200	2.1	12,000	3.5	14,400	4.2	471	808	1,130
	5	7	-	-	12	1.6	2.5	-	-	8,640	2.5	14,400	4.2	17,280	5.1	566	983	1,397
	5	9	-	-	14	1.6	3.2	-	-	10,080	3.0	16,800	4.9	20,160	5.9	685	1,163	1,643
	7	7	-	-	14	2.5	2.5	-	-	10,080	3.0	16,800	4.9	20,160	5.9	685	1,163	1,643
	7	9	-	-	16	2.5	3.2	-	-	11,520	3.4	19,200	5.6	23,040	6.8	783	1,348	1,928
	5	12	-	-	17	1.6	3.9	-	-	12,240	3.6	20,400	6.0	24,480	7.2	832	1,456	2,057
	9	9	-	-	18	3.2	3.2	-	-	12,960	3.8	21,600	6.3	25,920	7.6	882	1,537	2,189
	7	12	-	-	19	2.5	3.9	-	-	13,680	4.0	22,800	6.7	27,360	8.0	932	1,648	2,323
	5	15	-	-	20	1.6	4.8	-	-	14,400	4.2	24,000	7.0	28,800	8.4	983	1,732	2,459
	9	12	-	-	21	3.2	3.9	-	-	15,120	4.4	25,200	7.4	30,240	8.9	1,034	1,846	2,644
	7	15	-	-	22	2.5	4.8	-	-	15,840	4.6	26,400	7.7	31,680	9.3	1,085	1,932	2,877
	5	18	-	-	23	1.6	5.8	-	-	16,560	4.9	27,600	8.1	32,000	9.4	1,163	2,049	2,955
	9	15	-	-	24	3.2	4.8	-	-	17,280	5.1	28,800	8.4	32,000	9.4	1,215	2,138	2,955
	12	12	-	-	24	3.9	3.9	-	-	17,280	5.1	28,800	8.4	32,000	9.4	1,215	2,138	2,955
	7	18	-	-	25	2.5	5.8	-	-	17,280	5.1	28,800	8.4	32,000	9.4	1,215	2,138	2,955
	9	18	-	-	27	3.2	5.8	-	-	17,280	5.1	28,800	8.4	32,000	9.4	1,215	2,138	2,955
	12	15	-	-	27	3.9	4.8	-	-	17,280	5.1	28,800	8.4	32,000	9.4	1,215	2,138	2,955
	5	24	-	-	29	1.6	7.4	-	-	17,280	5.1	28,800	8.4	32,000	9.4	1,215	2,138	2,955
	12	18	-	-	30	3.9	5.8	-	-	17,280	5.1	28,800	8.4	32,000	9.4	1,215	2,138	2,955
	15	15	-	-	30	4.8	4.8	-	-	17,280	5.1	28,800	8.4	32,000	9.4	1,215	2,138	2,955
	7	24	-	-	31	2.5	7.4	-	-	17,280	5.1	28,800	8.4	32,000	9.4	1,215	2,138	2,955
9	24	-	-	33	3.2	7.4	-	-	17,280	5.1	28,800	8.4	32,000	9.4	1,215	2,138	2,955	
15	18	-	-	33	4.8	5.8	-	-	17,280	5.1	28,800	8.4	32,000	9.4	1,215	2,138	2,955	
18	18	-	-	36	5.8	5.8	-	-	17,280	5.1	28,800	8.4	32,000	9.4	1,215	2,138	2,955	
12	24	-	-	36	3.9	7.4	-	-	17,280	5.1	28,800	8.4	32,000	9.4	1,215	2,138	2,955	
3 Блока	5	5	5	-	15	1.6	1.6	1.6	-	10,800	3.2	18,000	5.3	21,600	6.3	690	1,192	1,662
	5	5	7	-	17	1.6	1.6	2.5	-	12,240	3.6	20,400	6.0	24,480	7.2	782	1,368	1,934
	5	5	9	-	19	1.6	1.6	3.2	-	13,680	4.0	22,800	6.7	27,360	8.0	876	1,549	2,183
	5	7	7	-	19	1.6	2.5	2.5	-	13,680	4.0	22,800	6.7	27,360	8.0	876	1,549	2,183
	5	7	9	-	21	1.6	2.5	3.2	-	15,120	4.4	25,200	7.4	30,240	8.9	972	1,735	2,486
	7	7	7	-	21	2.5	2.5	2.5	-	15,120	4.4	25,200	7.4	30,240	8.9	972	1,735	2,486
	5	5	12	-	22	1.6	1.6	3.9	-	15,840	4.6	26,400	7.7	31,680	9.3	1,020	1,817	2,650
	5	9	9	-	23	1.6	3.2	3.2	-	16,560	4.9	27,600	8.1	32,000	9.4	1,093	1,926	2,694
	7	7	9	-	23	2.5	2.5	3.2	-	16,560	4.9	27,600	8.1	32,000	9.4	1,093	1,926	2,694
	5	7	12	-	24	1.6	2.5	3.9	-	17,280	5.1	28,800	8.4	32,000	9.4	1,142	2,010	2,694
	5	5	15	-	25	1.6	1.6	4.8	-	17,280	5.1	28,800	8.4	32,000	9.4	1,142	2,010	2,694
	7	9	9	-	25	2.5	3.2	3.2	-	17,280	5.1	28,800	8.4	32,000	9.4	1,142	2,010	2,694
	5	9	12	-	26	1.6	3.2	3.9	-	17,280	5.1	28,800	8.4	32,000	9.4	1,142	2,010	2,694
	7	7	12	-	26	2.5	2.5	3.9	-	17,280	5.1	28,800	8.4	32,000	9.4	1,142	2,010	2,694
	5	7	15	-	27	1.6	2.5	4.8	-	17,280	5.1	28,800	8.4	32,000	9.4	1,142	2,010	2,694
	9	9	9	-	27	3.2	3.2	3.2	-	17,280	5.1	28,800	8.4	32,000	9.4	1,142	2,010	2,694
	7	9	12	-	28	2.5	3.2	3.9	-	17,280	5.1	28,800	8.4	32,000	9.4	1,142	2,010	2,694
	5	5	18	-	28	1.6	1.6	5.8	-	17,280	5.1	28,800	8.4	32,000	9.4	1,142	2,010	2,694
	5	9	15	-	29	1.6	3.2	4.8	-	17,280	5.1	28,800	8.4	32,000	9.4	1,142	2,010	2,694
	5	12	12	-	29	1.6	3.9	3.9	-	17,280	5.1	28,800	8.4	32,000	9.4	1,142	2,010	2,694
	7	7	15	-	29	2.5	2.5	4.8	-	17,280	5.1	28,800	8.4	32,000	9.4	1,142	2,010	2,694
	5	7	18	-	30	1.6	2.5	5.8	-	17,280	5.1	28,800	8.4	32,000	9.4	1,142	2,010	2,694
	9	9	12	-	30	3.2	3.2	3.9	-	17,280	5.1	28,800	8.4	32,000	9.4	1,142	2,010	2,694
	7	9	15	-	31	2.5	3.2	4.8	-	17,280	5.1	28,800	8.4	32,000	9.4	1,142	2,010	2,694
	7	12	12	-	31	2.5	3.9	3.9	-	17,280	5.1	28,800	8.4	32,000	9.4	1,142	2,010	2,694
	5	12	15	-	32	1.6	3.9	4.8	-	17,280	5.1	28,800	8.4	32,000	9.4	1,142	2,010	2,694
	5	9	18	-	32	1.6	3.2	5.8	-	17,280	5.1	28,800	8.4	32,000	9.4	1,142	2,010	2,694
	7	7	18	-	32	2.5	2.5	5.8	-	17,280	5.1	28,800	8.4	32,000	9.4	1,142	2,010	2,694
	9	9	15	-	33	3.2	3.2	4.8	-	17,280	5.1	28,800	8.4	32,000	9.4	1,142	2,010	2,694
	9	12	12	-	33	3.2	3.9	3.9	-	17,280	5.1	28,800	8.4	32,000	9.4	1,142	2,010	2,694
	7	9	18	-	34	2.5	3.2	5.8	-	17,280	5.1	28,800	8.4	32,000	9.4	1,142	2,010	2,694
	7	12	15	-	34	2.5	3.9	4.8	-	17,280	5.1	28,800	8.4	32,000	9.4	1,142	2,010	2,694
	5	5	24	-	34	1.6	1.6	7.4	-	17,280	5.1	28,800	8.4	32,000	9.4	1,142	2,010	2,694
	5	12	18	-	35	1.6	3.9	5.8	-	17,280	5.1	28,800	8.4	32,000	9.4	1,142	2,010	2,694
	5	15	15	-	35	1.6	4.8	4.8	-	17,280	5.1	28,800	8.4	32,000	9.4	1,142	2,010	2,694
	5	7	24	-	36	1.6	2.5	7.4	-	17,280	5.1	28,800	8.4	32,000	9.4	1,142	2,010	2,694
	9	12	15	-	36	3.2	3.9	4.8	-	17,280	5.1	28,800	8.4	32,000	9.4	1,142	2,010	2,694
	12	12	12	-	36	3.9	3.9	3.9	-	17,280	5.1	28,800	8.4	32,000	9.4	1,142	2,010	2,694
	9	9	18	-	36	3.2	3.2	5.8	-	17,280	5.1	28,800	8.4	32,000	9.4	1,142	2,010	2,694
	7	12	18	-	37	2.5	3.9	5.8	-	17,280	5.1	28,800	8.4	32,000	9.4	1,142	2,010	2,694
	7	15	15	-	37	2.5	4.8	4.8	-	17,280	5.1	28,800	8.4	32,000	9.4	1,142	2,010	2,694
	5	9	24	-	38	1.6	3.2	7.4	-	17,280	5.1	28,800	8.4	32,000	9.4	1,142	2,010	2,694
5	15	18	-	38	2.5	2.5	5.8	-	17,280	5.1	28,800	8.4	32,000	9.4	1,142	2,010	2,694	
7	7	24	-	38	2.5	2.5	7.4	-	17,280	5.1	28,800	8.4	32,000	9.4	1,142	2,010	2,694	
9	12	18	-	39	3.2	3.9	5.8	-	17,280	5.1	28,800	8.4	32,000	9.4	1,142	2,010	2,694	
9	15	15	-	39	3.2	4.8	4.8	-	17,280	5.1	28,800	8.4	32,000	9.4	1,142	2,010	2,694	
12	12	15	-	39	3.9	3.9	4.8	-	17,280	5.1	28,800	8.4						

Режим работы	Комбинации внутренних блоков (кВт/ч)					Нагрев												
						Производительность (кВт)				Общая производительность						Потребляемая мощность (Вт)		
	1 Блок	БЛОК А	БЛОК В	БЛОК С	БЛОК D	Всего	БЛОК А	БЛОК В	БЛОК С	БЛОК D	Минимум		Номинал		Максимум		Минимум	Номинал
Бте/ч											кВт	Бте/ч	кВт	Бте/ч	кВт			
	5	5	5	5	20	1.6	1.6	1.6	1.6	14,400	4.2	24,000	7.0	28,800	8.4	878	1,547	2,195
	5	5	5	7	22	1.6	1.6	1.6	2.5	15,840	4.6	26,400	7.7	31,680	9.3	969	1,726	2,527
	5	5	5	9	24	1.6	1.6	1.6	3.2	17,280	5.1	28,800	8.4	32,000	9.4	1,085	1,909	2,575
	5	5	7	7	24	1.6	1.6	2.5	2.5	17,280	5.1	28,800	8.4	32,000	9.4	1,085	1,909	2,575
	5	5	7	9	26	1.6	1.6	2.5	3.2	17,280	5.1	28,800	8.4	32,000	9.4	1,085	1,909	2,575
	5	7	7	7	26	1.6	2.5	2.5	2.5	17,280	5.1	28,800	8.4	32,000	9.4	1,085	1,909	2,575
	5	5	5	12	27	1.6	1.6	1.6	3.9	17,280	5.1	28,800	8.4	32,000	9.4	1,085	1,909	2,575
	5	5	9	9	28	1.6	1.6	3.2	3.2	17,280	5.1	28,800	8.4	32,000	9.4	1,085	1,909	2,575
	5	7	7	9	28	1.6	2.5	2.5	3.2	17,280	5.1	28,800	8.4	32,000	9.4	1,085	1,909	2,575
	7	7	7	7	28	2.5	2.5	2.5	2.5	17,280	5.1	28,800	8.4	32,000	9.4	1,085	1,909	2,575
	5	5	7	12	29	1.6	1.6	2.5	3.9	17,280	5.1	28,800	8.4	32,000	9.4	1,085	1,909	2,575
	5	5	5	15	30	1.6	1.6	1.6	4.8	17,280	5.1	28,800	8.4	32,000	9.4	1,085	1,909	2,575
	5	7	9	9	30	1.6	2.5	3.2	3.2	17,280	5.1	28,800	8.4	32,000	9.4	1,085	1,909	2,575
	7	7	7	9	30	2.5	2.5	2.5	2.5	17,280	5.1	28,800	8.4	32,000	9.4	1,085	1,909	2,575
	5	5	9	12	31	1.6	1.6	3.2	3.9	17,280	5.1	28,800	8.4	32,000	9.4	1,085	1,909	2,575
	5	7	7	12	31	1.6	2.5	2.5	3.9	17,280	5.1	28,800	8.4	32,000	9.4	1,085	1,909	2,575
	5	5	7	15	32	1.6	1.6	2.5	4.8	17,280	5.1	28,800	8.4	32,000	9.4	1,085	1,909	2,575
	7	7	9	9	32	2.5	2.5	3.2	3.2	17,280	5.1	28,800	8.4	32,000	9.4	1,085	1,909	2,575
	5	9	9	9	32	1.6	3.2	3.2	3.2	17,280	5.1	28,800	8.4	32,000	9.4	1,085	1,909	2,575
	5	5	5	18	33	1.6	1.6	1.6	5.8	17,280	5.1	28,800	8.4	32,000	9.4	1,085	1,909	2,575
	5	7	9	12	33	1.6	2.5	3.2	3.9	17,280	5.1	28,800	8.4	32,000	9.4	1,085	1,909	2,575
	7	7	7	12	33	2.5	2.5	2.5	3.9	17,280	5.1	28,800	8.4	32,000	9.4	1,085	1,909	2,575
4 Блок	5	5	9	15	34	1.6	1.6	3.2	4.8	17,280	5.1	28,800	8.4	32,000	9.4	1,085	1,909	2,575
	5	5	12	12	34	1.6	1.6	3.9	3.9	17,280	5.1	28,800	8.4	32,000	9.4	1,085	1,909	2,575
	5	7	7	15	34	1.6	2.5	2.5	4.8	17,280	5.1	28,800	8.4	32,000	9.4	1,085	1,909	2,575
	7	9	9	9	34	2.5	3.2	3.2	3.2	17,280	5.1	28,800	8.4	32,000	9.4	1,085	1,909	2,575
	5	5	7	18	35	1.6	1.6	2.5	5.8	17,280	5.1	28,800	8.4	32,000	9.4	1,085	1,909	2,575
	5	9	9	12	35	1.6	3.2	3.2	3.9	17,280	5.1	28,800	8.4	32,000	9.4	1,085	1,909	2,575
	7	7	9	12	35	2.5	2.5	3.2	3.9	17,280	5.1	28,800	8.4	32,000	9.4	1,085	1,909	2,575
	5	7	9	15	36	1.6	2.5	3.2	4.8	17,280	5.1	28,800	8.4	32,000	9.4	1,085	1,909	2,575
	5	7	12	12	36	1.6	2.5	3.9	3.9	17,280	5.1	28,800	8.4	32,000	9.4	1,085	1,909	2,575
	7	7	7	15	36	2.5	2.5	2.5	4.8	17,280	5.1	28,800	8.4	32,000	9.4	1,085	1,909	2,575
	9	9	9	9	36	3.2	3.2	3.2	3.2	17,280	5.1	28,800	8.4	32,000	9.4	1,085	1,909	2,575
	5	5	9	18	37	1.6	1.6	3.2	5.8	17,280	5.1	28,800	8.4	32,000	9.4	1,085	1,909	2,575
	5	5	12	15	37	1.6	1.6	3.9	4.8	17,280	5.1	28,800	8.4	32,000	9.4	1,085	1,909	2,575
	5	7	7	18	37	1.6	2.5	2.5	5.8	17,280	5.1	28,800	8.4	32,000	9.4	1,085	1,909	2,575
	7	9	9	12	37	2.5	3.2	3.2	3.9	17,280	5.1	28,800	8.4	32,000	9.4	1,085	1,909	2,575
	5	9	9	15	38	1.6	3.2	3.2	4.8	17,280	5.1	28,800	8.4	32,000	9.4	1,085	1,909	2,575
	7	7	9	15	38	2.5	2.5	3.2	4.8	17,280	5.1	28,800	8.4	32,000	9.4	1,085	1,909	2,575
	7	7	12	12	38	2.5	2.5	3.9	3.9	17,280	5.1	28,800	8.4	32,000	9.4	1,085	1,909	2,575
	5	5	5	24	39	1.6	1.6	1.6	7.4	17,280	5.1	28,800	8.4	32,000	9.4	1,085	1,909	2,575
	5	7	9	18	39	1.6	2.5	3.2	5.8	17,280	5.1	28,800	8.4	32,000	9.4	1,085	1,909	2,575
	5	7	12	15	39	1.6	2.5	3.9	4.8	17,280	5.1	28,800	8.4	32,000	9.4	1,085	1,909	2,575
	9	9	9	12	39	3.2	3.2	3.2	3.9	17,280	5.1	28,800	8.4	32,000	9.4	1,085	1,909	2,575
	7	7	7	18	39	2.5	2.5	2.5	5.8	17,280	5.1	28,800	8.4	32,000	9.4	1,085	1,909	2,575

Примечание:

1. Производительность охлаждения указана для следующих условий: температура в помещении 27 °Сст / 19 °Свт; температура наружного воздуха 35 °Сст
2. Производительность нагрева указана для следующих условий: температура в помещении 20 °Сст; температура наружного воздуха 7 °Сст / 6 °Свт
3. Общая производительность подключенных внутренних блоков не должна превышать 39 кВт/ч

# MU4M27

Режим работы	Комбинации внутренних блоков (кВт/ч)					Охлаждение												
						Производительность (кВт)				Общая производительность						Потребляемая мощность (Вт)		
						БЛОК А	БЛОК В	БЛОК С	БЛОК D	Всего	БЛОК А	БЛОК В	БЛОК С	БЛОК D	Бте/ч	кВт	Бте/ч	кВт
1 Блок	5	-	-	-	5	1.5	-	-	-	4,500	1.3	5,000	1.5	6,000	1.8	416	467	684
	7	-	-	-	7	2.1	-	-	-	4,800	1.4	7,000	2.1	8,400	2.5	416	551	741
	9	-	-	-	9	2.6	-	-	-	5,400	1.6	9,000	2.6	10,800	3.2	416	689	961
	12	-	-	-	12	3.5	-	-	-	7,200	2.1	12,000	3.5	14,400	4.2	551	944	1,287
	15	-	-	-	15	4.4	-	-	-	8,520	2.5	14,200	4.2	17,040	5.0	661	1,149	1,557
	18	-	-	-	18	5.3	-	-	-	10,800	3.2	18,000	5.3	21,600	6.3	858	1,482	2,013
	24	-	-	-	24	7.0	-	-	-	14,400	4.2	24,000	7.0	25,500	7.5	1,149	2,026	2,830
2 Блока	5	5	-	-	10	1.5	1.5	-	-	6,000	1.8	10,000	2.9	12,000	3.5	423	696	952
	5	7	-	-	12	1.5	2.1	-	-	7,200	2.1	12,000	3.5	14,400	4.2	496	850	1,158
	5	9	-	-	14	1.5	2.6	-	-	8,400	2.5	14,000	4.1	16,800	4.9	595	1,008	1,370
	7	7	-	-	14	2.1	2.1	-	-	8,400	2.5	14,000	4.1	16,800	4.9	595	1,008	1,370
	7	9	-	-	16	2.1	2.6	-	-	9,600	2.8	16,000	4.7	19,200	5.6	670	1,169	1,588
	5	12	-	-	17	1.5	3.5	-	-	10,200	3.0	17,000	5.0	20,400	6.0	721	1,251	1,715
	9	9	-	-	18	2.6	2.6	-	-	10,800	3.2	18,000	5.3	21,600	6.3	772	1,334	1,812
	7	12	-	-	19	2.1	3.5	-	-	11,400	3.3	19,000	5.6	22,800	6.7	798	1,418	1,943
	5	15	-	-	20	1.5	4.4	-	-	12,000	3.5	20,000	5.9	24,000	7.0	850	1,503	2,042
	9	12	-	-	21	2.6	3.5	-	-	12,600	3.7	21,000	6.2	25,200	7.4	902	1,589	2,230
	7	15	-	-	22	2.1	4.4	-	-	13,200	3.9	22,000	6.4	26,400	7.7	955	1,647	2,376
	5	18	-	-	23	1.5	5.3	-	-	13,800	4.0	23,000	6.7	27,600	8.1	981	1,734	2,586
	9	15	-	-	24	2.6	4.4	-	-	14,400	4.2	24,000	7.0	28,800	8.4	1,034	1,823	2,756
	12	12	-	-	24	3.5	3.5	-	-	14,400	4.2	24,000	7.0	28,800	8.4	1,034	1,823	2,756
	7	18	-	-	25	2.1	5.3	-	-	15,000	4.4	25,000	7.3	30,000	8.8	1,088	1,948	2,993
	9	18	-	-	27	2.6	5.3	-	-	16,200	4.7	27,000	7.9	31,050	9.1	1,169	2,212	3,180
	12	15	-	-	27	3.5	4.4	-	-	16,200	4.7	27,000	7.9	31,050	9.1	1,169	2,212	3,180
	5	24	-	-	29	1.5	7.0	-	-	16,200	4.7	27,000	7.9	31,050	9.1	1,169	2,212	3,180
	12	18	-	-	30	3.5	5.3	-	-	16,200	4.7	27,000	7.9	31,050	9.1	1,169	2,212	3,180
	15	15	-	-	30	4.4	4.4	-	-	16,200	4.7	27,000	7.9	31,050	9.1	1,169	2,212	3,180
	7	24	-	-	31	2.1	7.0	-	-	16,200	4.7	27,000	7.9	31,050	9.1	1,169	2,212	3,180
9	24	-	-	33	2.6	7.0	-	-	16,200	4.7	27,000	7.9	31,050	9.1	1,169	2,212	3,180	
15	18	-	-	33	4.4	5.3	-	-	16,200	4.7	27,000	7.9	31,050	9.1	1,169	2,212	3,180	
18	18	-	-	36	5.3	5.3	-	-	16,200	4.7	27,000	7.9	31,050	9.1	1,169	2,212	3,180	
12	24	-	-	36	3.5	7.0	-	-	16,200	4.7	27,000	7.9	31,050	9.1	1,169	2,212	3,180	
15	24	-	-	39	4.4	7.0	-	-	16,200	4.7	27,000	7.9	31,050	9.1	1,169	2,212	3,180	
3 Блока	5	5	5	-	15	1.5	1.5	1.5	-	9,000	2.6	15,000	4.4	18,000	5.3	583	1,023	1,405
	5	5	7	-	17	1.5	1.5	2.1	-	10,200	3.0	17,000	5.0	20,400	6.0	678	1,176	1,613
	5	5	9	-	19	1.5	1.5	2.6	-	11,400	3.3	19,000	5.6	22,800	6.7	750	1,333	1,826
	5	7	7	-	19	1.5	2.1	2.1	-	11,400	3.3	19,000	5.6	22,800	6.7	750	1,333	1,826
	5	7	9	-	21	1.5	2.1	2.6	-	12,600	3.7	21,000	6.2	25,200	7.4	848	1,494	2,096
	7	7	7	-	21	2.1	2.1	2.1	-	12,600	3.7	21,000	6.2	25,200	7.4	848	1,494	2,096
	5	5	12	-	22	1.5	1.5	3.5	-	13,200	3.9	22,000	6.4	26,400	7.7	897	1,548	2,234
	5	9	9	-	23	1.5	2.6	2.6	-	13,800	4.0	23,000	6.7	27,600	8.1	922	1,630	2,441
	7	7	9	-	23	2.1	2.1	2.6	-	13,800	4.0	23,000	6.7	27,600	8.1	922	1,630	2,441
	5	7	12	-	24	1.5	2.1	3.5	-	14,400	4.2	24,000	7.0	28,800	8.4	972	1,714	2,617
	5	5	15	-	25	1.5	1.5	4.4	-	15,000	4.4	25,000	7.3	30,000	8.8	1,023	1,831	2,865
	7	9	9	-	25	2.1	2.6	2.6	-	15,000	4.4	25,000	7.3	30,000	8.8	1,023	1,831	2,865
	5	9	12	-	26	1.5	2.6	3.5	-	15,600	4.6	26,000	7.6	31,200	9.1	1,073	1,953	3,063
	7	7	12	-	26	2.1	2.1	3.5	-	15,600	4.6	26,000	7.6	31,200	9.1	1,073	1,953	3,063
	5	7	15	-	27	1.5	2.1	4.4	-	16,200	4.7	27,000	7.9	31,050	9.1	1,099	2,079	3,063
	9	9	9	-	27	2.6	2.6	2.6	-	16,200	4.7	27,000	7.9	31,050	9.1	1,099	2,079	3,063
	7	9	12	-	28	2.1	2.6	3.5	-	16,200	4.7	27,000	7.9	31,050	9.1	1,099	2,079	3,063
	5	5	18	-	28	1.5	1.5	5.3	-	16,200	4.7	27,000	7.9	31,050	9.1	1,099	2,079	3,063
	5	9	15	-	29	1.5	2.6	4.4	-	16,200	4.7	27,000	7.9	31,050	9.1	1,099	2,079	3,063
	5	12	12	-	29	1.5	3.5	3.5	-	16,200	4.7	27,000	7.9	31,050	9.1	1,099	2,079	3,063
	7	7	15	-	29	2.1	2.1	4.4	-	16,200	4.7	27,000	7.9	31,050	9.1	1,099	2,079	3,063
	5	7	18	-	30	1.5	2.1	5.3	-	16,200	4.7	27,000	7.9	31,050	9.1	1,099	2,079	3,063
	9	9	12	-	30	2.6	2.6	3.5	-	16,200	4.7	27,000	7.9	31,050	9.1	1,099	2,079	3,063
	7	9	15	-	31	2.1	2.6	4.4	-	16,200	4.7	27,000	7.9	31,050	9.1	1,099	2,079	3,063
	7	12	12	-	31	2.1	3.5	3.5	-	16,200	4.7	27,000	7.9	31,050	9.1	1,099	2,079	3,063
	5	12	15	-	32	1.5	3.5	4.4	-	16,200	4.7	27,000	7.9	31,050	9.1	1,099	2,079	3,063
	5	9	18	-	32	1.5	2.6	5.3	-	16,200	4.7	27,000	7.9	31,050	9.1	1,099	2,079	3,063
	7	7	18	-	32	2.1	2.1	5.3	-	16,200	4.7	27,000	7.9	31,050	9.1	1,099	2,079	3,063
	9	9	15	-	33	2.6	2.6	4.4	-	16,200	4.7	27,000	7.9	31,050	9.1	1,099	2,079	3,063
	9	12	12	-	33	2.6	3.5	3.5	-	16,200	4.7	27,000	7.9	31,050	9.1	1,099	2,079	3,063
	7	9	18	-	34	2.1	2.6	5.3	-	16,200	4.7	27,000	7.9	31,050	9.1	1,099	2,079	3,063
	7	12	15	-	34	2.1	3.5	4.4	-	16,200	4.7	27,000	7.9	31,050	9.1	1,099	2,079	3,063
	5	5	24	-	34	1.5	1.5	7.0	-	16,200	4.7	27,000	7.9	31,050	9.1	1,099	2,079	3,063
	5	12	18	-	35	1.5	3.5	5.3	-	16,200	4.7	27,000	7.9	31,050	9.1	1,099	2,079	3,063
	5	15	15	-	35	1.5	4.4	4.4	-	16,200	4.7	27,000	7.9	31,050	9.1	1,099	2,079	3,063
	5	7	24	-	36	1.5	2.1	7.0	-	16,200	4.7	27,000	7.9	31,050	9.1	1,099	2,079	3,063
	9	12	15	-	36	2.6	3.5	4.4	-	16,200	4.7	27,000	7.9	31,050	9.1	1,099	2,079	3,063
	12	12	12	-	36	3.5	3.5	3.5	-	16,200	4.7	27,000	7.9	31,050	9.1	1,099	2,079	3,063
	9	9	18	-	36	2.6	2.6	5.3	-	16,200	4.7	27,000	7.9	31,050	9.1	1,099	2,079	3,063
	7	12	18	-	37	2.1	3.5	5.3	-	16,200	4.7	27,000	7.9	31,050	9.1	1,099	2,079	3,063
	7	15	15	-	37	2.1	4.4	4.4	-	16,200	4.7	27,000	7.9	31,050	9.1	1,099	2,079	3,063
5	9	24	-	38	1.5	2.6	7.0	-	16,200	4.7	27,000	7.9	31,050	9.1	1,099	2,079	3,063	
5	15	18	-	38	1.5	4.4	5.3	-	16,200	4.7	27,000	7.9	31,050	9.1	1,099	2,079	3,063	
7	7	24	-	38	2.1	2.1	7.0	-	16,200	4.7	27,000	7.9	31,050	9.1	1,099	2,079	3,063	
9	12	18	-	39	2.6	3.5	5.3	-	16,200	4.7	27,000	7.9	31,050	9.1	1,099	2,079	3,063	
9	15	15	-	39	2.6	4.4	4.4	-	16,200	4.7	27,000	7.9	31,050	9.1	1,099	2		

Режим работы	Комбинации внутренних блоков (кВт/ч)					Охлаждение												
						Производительность (кВт)				Общая производительность						Потребляемая мощность (Вт)		
						БЛОК А	БЛОК В	БЛОК С	БЛОК D	Всего	Минимум		Номинал		Максимум		Минимум	Номинал
БЛОК А	БЛОК В	БЛОК С	БЛОК D	Бте/ч	кВт						Бте/ч	кВт	Бте/ч	кВт				
4 Блока	5	5	5	5	20	1.5	1.5	1.5	1.5	12,000	3.5	20,000	5.9	24,000	7.0	759	1,342	1,823
	5	5	5	7	22	1.5	1.5	1.5	2.1	13,200	3.9	22,000	6.4	26,400	7.7	853	1,471	2,122
	5	5	5	9	24	1.5	1.5	1.5	2.6	14,400	4.2	24,000	7.0	28,800	8.4	924	1,628	2,436
	5	5	7	7	24	1.5	1.5	2.1	2.1	14,400	4.2	24,000	7.0	28,800	8.4	924	1,628	2,436
	5	5	7	9	26	1.5	1.5	2.1	2.6	15,600	4.6	26,000	7.6	31,200	9.1	1,020	1,855	2,772
	5	7	7	7	26	1.5	2.1	2.1	2.1	15,600	4.6	26,000	7.6	31,200	9.1	1,020	1,855	2,772
	5	5	5	12	27	1.5	1.5	1.5	3.5	16,200	4.7	27,000	7.9	32,400	9.5	1,044	1,975	2,976
	5	5	9	9	28	1.5	1.5	2.6	2.6	16,200	4.7	27,000	7.9	32,400	9.5	1,044	1,975	2,976
	5	7	7	9	28	1.5	2.1	2.1	2.6	16,200	4.7	27,000	7.9	32,400	9.5	1,044	1,975	2,976
	7	7	7	7	28	2.1	2.1	2.1	2.1	16,200	4.7	27,000	7.9	32,400	9.5	1,044	1,975	2,976
	5	5	7	12	29	1.5	1.5	2.1	3.5	16,200	4.7	27,000	7.9	32,400	9.5	1,044	1,975	2,976
	5	5	5	15	30	1.5	1.5	1.5	4.4	16,200	4.7	27,000	7.9	32,400	9.5	1,044	1,975	2,976
	5	7	9	9	30	1.5	2.1	2.6	2.6	16,200	4.7	27,000	7.9	32,400	9.5	1,044	1,975	2,976
	7	7	7	9	30	2.1	2.1	2.1	2.6	16,200	4.7	27,000	7.9	32,400	9.5	1,044	1,975	2,976
	5	5	9	12	31	1.5	1.5	2.6	3.5	16,200	4.7	27,000	7.9	32,400	9.5	1,044	1,975	2,976
	5	7	7	12	31	1.5	2.1	2.1	3.5	16,200	4.7	27,000	7.9	32,400	9.5	1,044	1,975	2,976
	5	5	7	15	32	1.5	1.5	2.1	4.4	16,200	4.7	27,000	7.9	32,400	9.5	1,044	1,975	2,976
	7	7	9	9	32	2.1	2.1	2.6	2.6	16,200	4.7	27,000	7.9	32,400	9.5	1,044	1,975	2,976
	5	9	9	9	32	1.5	2.6	2.6	2.6	16,200	4.7	27,000	7.9	32,400	9.5	1,044	1,975	2,976
	5	5	5	18	33	1.5	1.5	1.5	5.3	16,200	4.7	27,000	7.9	32,400	9.5	1,044	1,975	2,976
	5	7	9	12	33	1.5	2.1	2.6	3.5	16,200	4.7	27,000	7.9	32,400	9.5	1,044	1,975	2,976
	7	7	7	12	33	2.1	2.1	2.1	3.5	16,200	4.7	27,000	7.9	32,400	9.5	1,044	1,975	2,976
	5	5	9	15	34	1.5	1.5	2.6	4.4	16,200	4.7	27,000	7.9	32,400	9.5	1,044	1,975	2,976
	5	5	12	12	34	1.5	1.5	3.5	3.5	16,200	4.7	27,000	7.9	32,400	9.5	1,044	1,975	2,976
	5	7	7	15	34	1.5	2.1	2.1	4.4	16,200	4.7	27,000	7.9	32,400	9.5	1,044	1,975	2,976
	7	9	9	9	34	2.1	2.6	2.6	2.6	16,200	4.7	27,000	7.9	32,400	9.5	1,044	1,975	2,976
	5	5	7	18	35	1.5	1.5	2.1	5.3	16,200	4.7	27,000	7.9	32,400	9.5	1,044	1,975	2,976
	5	9	9	12	35	1.5	2.6	2.6	3.5	16,200	4.7	27,000	7.9	32,400	9.5	1,044	1,975	2,976
	7	7	9	12	35	2.1	2.1	2.6	3.5	16,200	4.7	27,000	7.9	32,400	9.5	1,044	1,975	2,976
	5	7	9	15	36	1.5	2.1	2.6	4.4	16,200	4.7	27,000	7.9	32,400	9.5	1,044	1,975	2,976
	5	7	12	12	36	1.5	2.1	3.5	3.5	16,200	4.7	27,000	7.9	32,400	9.5	1,044	1,975	2,976
	7	7	7	15	36	2.1	2.1	2.1	4.4	16,200	4.7	27,000	7.9	32,400	9.5	1,044	1,975	2,976
	9	9	9	9	36	2.6	2.6	2.6	2.6	16,200	4.7	27,000	7.9	32,400	9.5	1,044	1,975	2,976
	5	5	9	18	37	1.5	1.5	2.6	5.3	16,200	4.7	27,000	7.9	32,400	9.5	1,044	1,975	2,976
	5	5	12	15	37	1.5	1.5	3.5	4.4	16,200	4.7	27,000	7.9	32,400	9.5	1,044	1,975	2,976
	5	7	7	18	37	1.5	2.1	2.1	5.3	16,200	4.7	27,000	7.9	32,400	9.5	1,044	1,975	2,976
	7	9	9	12	37	2.1	2.6	2.6	3.5	16,200	4.7	27,000	7.9	32,400	9.5	1,044	1,975	2,976
	5	9	9	15	38	1.5	2.6	2.6	4.4	16,200	4.7	27,000	7.9	32,400	9.5	1,044	1,975	2,976
	7	7	9	15	38	2.1	2.1	2.6	4.4	16,200	4.7	27,000	7.9	32,400	9.5	1,044	1,975	2,976
	7	7	12	12	38	2.1	2.1	3.5	3.5	16,200	4.7	27,000	7.9	32,400	9.5	1,044	1,975	2,976
	5	5	5	24	39	1.5	1.5	1.5	7.0	16,200	4.7	27,000	7.9	32,400	9.5	1,044	1,975	2,976
5	7	9	18	39	1.5	2.1	2.6	5.3	16,200	4.7	27,000	7.9	32,400	9.5	1,044	1,975	2,976	
5	7	12	15	39	1.5	2.1	3.5	4.4	16,200	4.7	27,000	7.9	32,400	9.5	1,044	1,975	2,976	
9	9	9	12	39	2.6	2.6	2.6	3.5	16,200	4.7	27,000	7.9	32,400	9.5	1,044	1,975	2,976	
7	7	7	18	39	2.1	2.1	2.1	5.3	16,200	4.7	27,000	7.9	32,400	9.5	1,044	1,975	2,976	
7	9	9	15	40	2.1	2.6	2.6	4.4	16,200	4.7	27,000	7.9	32,400	9.5	1,044	1,975	2,976	
7	9	12	12	40	2.1	2.6	3.5	3.5	16,200	4.7	27,000	7.9	32,400	9.5	1,044	1,975	2,976	
5	5	7	24	41	1.5	1.5	2.1	7.0	16,200	4.7	27,000	7.9	32,400	9.5	1,044	1,975	2,976	
5	9	12	15	41	1.5	2.6	3.5	4.4	16,200	4.7	27,000	7.9	32,400	9.5	1,044	1,975	2,976	
5	12	12	12	41	1.5	3.5	3.5	3.5	16,200	4.7	27,000	7.9	32,400	9.5	1,044	1,975	2,976	
7	7	12	15	41	2.1	2.1	3.5	4.4	16,200	4.7	27,000	7.9	32,400	9.5	1,044	1,975	2,976	
7	7	9	18	41	2.1	2.1	2.6	5.3	16,200	4.7	27,000	7.9	32,400	9.5	1,044	1,975	2,976	

Примечание:

1. Производительность охлаждения указана для следующих условий: температура в помещении 27 °Сст / 19 °Сст; температура наружного воздуха 35 °Сст
2. Производительность нагрева указана для следующих условий: температура в помещении 20 °Сст; температура наружного воздуха 7 °Сст / 6 °Сст
3. Общая производительность подключенных внутренних блоков не должна превышать 41 кВт/ч

# MU4M27

Режим работы	Комбинации внутренних блоков (кВт/ч)					Нагрев													
						Производительность (кВт)				Общая производительность						Потребляемая мощность (Вт)			
						БЛОК А	БЛОК В	БЛОК С	БЛОК D	Всего	БЛОК А	БЛОК В	БЛОК С	БЛОК D	Бте/ч	кВт	Бте/ч	кВт	Бте/ч
1 Блок	5	-	-	-	5	1.6	-	-	-	5,000	1.5	5,500	1.6	6,325	1.9	610	610	747	
	7	-	-	-	7	2.5	-	-	-	5,400	1.6	8,400	2.5	9,660	2.8	610	665	862	
	9	-	-	-	9	3.2	-	-	-	6,480	1.9	10,800	3.2	12,420	3.6	610	864	1,126	
	12	-	-	-	12	3.9	-	-	-	7,920	2.3	13,200	3.9	15,180	4.4	610	1,067	1,399	
	15	-	-	-	15	4.8	-	-	-	9,900	2.9	16,500	4.8	18,975	5.6	778	1,337	1,823	
	18	-	-	-	18	5.8	-	-	-	11,880	3.5	19,800	5.8	22,770	6.7	950	1,649	2,230	
	24	-	-	-	24	7.4	-	-	-	15,240	4.5	25,400	7.4	26,670	7.8	1,246	2,172	2,654	
2 Блока	5	5	-	-	10	1.6	1.6	-	-	7,200	2.1	12,000	3.5	14,400	4.2	471	808	1,130	
	5	7	-	-	12	1.6	2.5	-	-	8,640	2.5	14,400	4.2	17,280	5.1	566	983	1,397	
	5	9	-	-	14	1.6	3.2	-	-	10,080	3.0	16,800	4.9	20,160	5.9	685	1,163	1,643	
	7	7	-	-	14	2.5	2.5	-	-	10,080	3.0	16,800	4.9	20,160	5.9	685	1,163	1,643	
	7	9	-	-	16	2.5	3.2	-	-	11,520	3.4	19,200	5.6	23,040	6.8	783	1,348	1,928	
	5	12	-	-	17	1.6	3.9	-	-	12,240	3.6	20,400	6.0	24,480	7.2	832	1,456	2,057	
	9	9	-	-	18	3.2	3.2	-	-	12,960	3.8	21,600	6.3	25,920	7.6	882	1,537	2,189	
	7	12	-	-	19	2.5	3.9	-	-	13,680	4.0	22,800	6.7	27,360	8.0	932	1,648	2,323	
	5	15	-	-	20	1.6	4.8	-	-	14,400	4.2	24,000	7.0	28,800	8.4	983	1,732	2,459	
	9	12	-	-	21	3.2	3.9	-	-	15,120	4.4	25,200	7.4	30,240	8.9	1,034	1,846	2,644	
	7	15	-	-	22	2.5	4.8	-	-	15,840	4.6	26,400	7.7	31,680	9.3	1,085	1,932	2,877	
	5	18	-	-	23	1.6	5.8	-	-	16,560	4.9	27,600	8.1	33,120	9.7	1,163	2,049	3,200	
	9	15	-	-	24	3.2	4.8	-	-	17,280	5.1	28,800	8.4	34,100	10.0	1,228	2,138	3,463	
	12	12	-	-	24	3.9	3.9	-	-	17,280	5.1	28,800	8.4	34,100	10.0	1,228	2,138	3,463	
	7	18	-	-	25	2.5	5.8	-	-	18,000	5.3	30,000	8.8	34,100	10.0	1,280	2,267	3,463	
	9	18	-	-	27	3.2	5.8	-	-	18,600	5.5	31,000	9.1	34,100	10.0	1,333	2,234	3,463	
	12	15	-	-	27	3.9	4.8	-	-	18,600	5.5	31,000	9.1	34,100	10.0	1,333	2,234	3,463	
	5	24	-	-	29	1.6	7.4	-	-	18,600	5.5	31,000	9.1	34,100	10.0	1,333	2,234	3,463	
	3 Блока	12	18	-	-	30	3.9	5.8	-	-	18,600	5.5	31,000	9.1	34,100	10.0	1,333	2,234	3,463
		15	15	-	-	30	4.8	4.8	-	-	18,600	5.5	31,000	9.1	34,100	10.0	1,333	2,234	3,463
7		24	-	-	31	2.5	7.4	-	-	18,600	5.5	31,000	9.1	34,100	10.0	1,333	2,234	3,463	
9		24	-	-	33	3.2	7.4	-	-	18,600	5.5	31,000	9.1	34,100	10.0	1,333	2,234	3,463	
15		18	-	-	33	4.8	5.8	-	-	18,600	5.5	31,000	9.1	34,100	10.0	1,333	2,234	3,463	
18		18	-	-	36	5.8	5.8	-	-	18,600	5.5	31,000	9.1	34,100	10.0	1,333	2,234	3,463	
12		24	-	-	36	3.9	7.4	-	-	18,600	5.5	31,000	9.1	34,100	10.0	1,333	2,234	3,463	
15		24	-	-	39	4.8	7.4	-	-	18,600	5.5	31,000	9.1	34,100	10.0	1,333	2,234	3,463	
5		5	5	-	15	1.6	1.6	1.6	-	10,800	3.2	18,000	5.3	21,600	6.3	690	1,192	1,662	
5		5	7	-	17	1.6	1.6	2.5	-	12,240	3.6	20,400	6.0	24,480	7.2	782	1,368	1,934	
5		5	9	-	19	1.6	1.6	3.2	-	13,680	4.0	22,800	6.7	27,360	8.0	876	1,549	2,183	
5		7	7	-	19	1.6	2.5	2.5	-	13,680	4.0	22,800	6.7	27,360	8.0	876	1,549	2,183	
5		7	9	-	21	1.6	2.5	3.2	-	15,120	4.4	25,200	7.4	30,240	8.9	972	1,735	2,486	
7		7	7	-	21	2.5	2.5	2.5	-	15,120	4.4	25,200	7.4	30,240	8.9	972	1,735	2,486	
5		5	12	-	22	1.6	1.6	3.9	-	15,840	4.6	26,400	7.7	31,680	9.3	1,020	1,817	2,650	
5		9	9	-	23	1.6	3.2	3.2	-	16,560	4.9	27,600	8.1	33,120	9.7	1,093	1,926	2,831	
7		7	9	-	23	2.5	2.5	3.2	-	16,560	4.9	27,600	8.1	33,120	9.7	1,093	1,926	2,831	
5		7	12	-	24	1.6	2.5	3.9	-	17,280	5.1	28,800	8.4	34,560	10.1	1,142	2,012	3,020	
5		5	15	-	25	1.6	1.6	4.8	-	18,000	5.3	30,000	8.8	34,720	10.2	1,192	2,131	3,068	
7		9	9	-	25	2.5	3.2	3.2	-	18,000	5.3	30,000	8.8	34,720	10.2	1,192	2,131	3,068	
5	9	12	-	26	1.6	3.2	3.9	-	18,720	5.5	31,200	9.1	34,720	10.2	1,242	2,228	3,068		
7	7	12	-	26	2.5	2.5	3.9	-	18,720	5.5	31,200	9.1	34,720	10.2	1,242	2,228	3,068		
5	7	15	-	27	1.6	2.5	4.8	-	18,600	5.5	31,000	9.1	34,720	10.2	1,242	2,228	3,068		
9	9	9	-	27	3.2	3.2	3.2	-	18,600	5.5	31,000	9.1	34,720	10.2	1,242	2,228	3,068		
7	9	12	-	28	2.5	3.2	3.9	-	18,600	5.5	31,000	9.1	34,720	10.2	1,242	2,228	3,068		
5	5	18	-	28	1.6	1.6	5.8	-	18,600	5.5	31,000	9.1	34,720	10.2	1,242	2,228	3,068		
5	9	15	-	29	1.6	3.2	4.8	-	18,600	5.5	31,000	9.1	34,720	10.2	1,242	2,228	3,068		
5	12	12	-	29	1.6	3.9	3.9	-	18,600	5.5	31,000	9.1	34,720	10.2	1,242	2,228	3,068		
7	7	15	-	29	2.5	2.5	4.8	-	18,600	5.5	31,000	9.1	34,720	10.2	1,242	2,228	3,068		
5	7	18	-	30	1.6	2.5	5.8	-	18,600	5.5	31,000	9.1	34,720	10.2	1,242	2,228	3,068		
9	9	12	-	30	3.2	3.2	3.9	-	18,600	5.5	31,000	9.1	34,720	10.2	1,242	2,228	3,068		
7	9	15	-	31	2.5	3.2	4.8	-	18,600	5.5	31,000	9.1	34,720	10.2	1,242	2,228	3,068		
7	12	12	-	31	2.5	3.9	3.9	-	18,600	5.5	31,000	9.1	34,720	10.2	1,242	2,228	3,068		
5	12	15	-	32	1.6	3.9	4.8	-	18,600	5.5	31,000	9.1	34,720	10.2	1,242	2,228	3,068		
5	9	18	-	32	1.6	3.2	5.8	-	18,600	5.5	31,000	9.1	34,720	10.2	1,242	2,228	3,068		
7	7	18	-	32	2.5	2.5	5.8	-	18,600	5.5	31,000	9.1	34,720	10.2	1,242	2,228	3,068		
9	9	15	-	33	3.2	3.2	4.8	-	18,600	5.5	31,000	9.1	34,720	10.2	1,242	2,228	3,068		
9	12	12	-	33	3.2	3.9	3.9	-	18,600	5.5	31,000	9.1	34,720	10.2	1,242	2,228	3,068		
7	9	18	-	34	2.5	3.2	5.8	-	18,600	5.5	31,000	9.1	34,720	10.2	1,242	2,228	3,068		
7	12	15	-	34	2.5	3.9	4.8	-	18,600	5.5	31,000	9.1	34,720	10.2	1,242	2,228	3,068		
5	5	24	-	34	1.6	1.6	7.4	-	18,600	5.5	31,000	9.1	34,720	10.2	1,242	2,228	3,068		
5	12	18	-	35	1.6	3.9	5.8	-	18,600	5.5	31,000	9.1	34,720	10.2	1,242	2,228	3,068		
5	15	15	-	35	1.6	4.8	4.8	-	18,600	5.5	31,000	9.1	34,720	10.2	1,242	2,228	3,068		
5	7	24	-	36	1.6	2.5	7.4	-	18,600	5.5	31,000	9.1	34,720	10.2	1,242	2,228	3,068		
9	12	15	-	36	3.2	3.9	4.8	-	18,600	5.5	31,000	9.1	34,720	10.2	1,242	2,228	3,068		
12	12	12	-	36	3.9	3.9	3.9	-	18,600	5.5	31,000	9.1	34,720	10.2	1,242	2,228	3,068		
9	9	18	-	36	3.2	3.2	5.8	-	18,600	5.5	31,000	9.1	34,720	10.2	1,242	2,228	3,068		
7	12	18	-	37	2.5	3.9	5.8	-	18,600	5.5	31,000	9.1	34,720	10.2	1,242	2,228	3,068		
7	15	15	-	37	2.5	4.8	4.8	-	18,600	5.5	31,000	9.1	34,720	10.2	1,242	2,228	3,068		
5	9	24	-	38	1.6	3.2	7.4	-	18,600	5.5	31,000	9.1	34,720	10.2	1,242	2,228	3,068		
5	15	18	-	38	2.5	2.5	5.8	-	18,600	5.5	31,000	9.1	34,720	10.2	1,242	2,228	3,068		
7	7	24	-	38	3.2	3.9	5.8	-	18,600	5.5	31,000	9.1	34,720	10.2	1,242	2,228	3,068		
9	12	18	-	39	3.2	4.8	4.8	-	18,600	5.5	31,000	9.1	34,720	10.2	1,242	2,228	3,068		
9	15	15	-	39	3.9	3.9	4.8												

Режим работы	Комбинации внутренних блоков (кВт/ч)					Нагрев												
						Производительность (кВт)				Общая производительность						Потребляемая мощность (Вт)		
	БЛОК А	БЛОК В	БЛОК С	БЛОК D	Всего	БЛОК А	БЛОК В	БЛОК С	БЛОК D	Бте/ч	кВт	Бте/ч	кВт	Бте/ч	кВт	Минимум	Номинал	Максимум
4 Блока	5	5	5	5	20	1.6	1.6	1.6	1.6	14,400	4.2	24,000	7.0	28,800	8.4	878	1,547	2,195
	5	5	5	7	22	1.6	1.6	1.6	2.5	15,840	4.6	26,400	7.7	31,680	9.3	969	1,726	2,527
	5	5	5	9	24	1.6	1.6	1.6	3.2	17,280	5.1	28,800	8.4	34,560	10.1	1,085	1,909	2,927
	5	5	7	7	24	1.6	1.6	2.5	2.5	17,280	5.1	28,800	8.4	34,560	10.1	1,085	1,909	2,927
	5	5	7	9	26	1.6	1.6	2.5	3.2	18,000	5.3	30,000	8.8	36,000	10.6	1,132	2,024	3,198
	5	7	7	7	26	1.6	2.5	2.5	2.5	18,000	5.3	30,000	8.8	36,000	10.6	1,132	2,024	3,198
	5	5	5	12	27	1.6	1.6	1.6	3.9	18,600	5.5	31,000	9.1	36,000	10.6	1,180	2,116	3,198
	5	5	9	9	28	1.6	1.6	3.2	3.2	18,600	5.5	31,000	9.1	36,000	10.6	1,180	2,116	3,198
	5	7	7	9	28	1.6	2.5	2.5	3.2	18,600	5.5	31,000	9.1	36,000	10.6	1,180	2,116	3,198
	7	7	7	7	28	2.5	2.5	2.5	2.5	18,600	5.5	31,000	9.1	36,000	10.6	1,180	2,116	3,198
	5	5	7	12	29	1.6	1.6	2.5	3.9	18,600	5.5	31,000	9.1	36,000	10.6	1,180	2,116	3,198
	5	5	5	15	30	1.6	1.6	1.6	4.8	18,600	5.5	31,000	9.1	36,000	10.6	1,180	2,116	3,198
	5	7	9	9	30	1.6	2.5	3.2	3.2	18,600	5.5	31,000	9.1	36,000	10.6	1,180	2,116	3,198
	7	7	7	9	30	2.5	2.5	2.5	3.2	18,600	5.5	31,000	9.1	36,000	10.6	1,180	2,116	3,198
	5	5	9	12	31	1.6	1.6	3.2	3.9	18,600	5.5	31,000	9.1	36,000	10.6	1,180	2,116	3,198
	5	7	7	12	31	1.6	2.5	2.5	3.9	18,600	5.5	31,000	9.1	36,000	10.6	1,180	2,116	3,198
	5	5	7	15	32	1.6	1.6	2.5	4.8	18,600	5.5	31,000	9.1	36,000	10.6	1,180	2,116	3,198
	7	7	9	9	32	2.5	2.5	3.2	3.2	18,600	5.5	31,000	9.1	36,000	10.6	1,180	2,116	3,198
	5	9	9	9	32	1.6	3.2	3.2	3.2	18,600	5.5	31,000	9.1	36,000	10.6	1,180	2,116	3,198
	5	5	5	18	33	1.6	1.6	1.6	5.8	18,600	5.5	31,000	9.1	36,000	10.6	1,180	2,116	3,198
	5	7	9	12	33	1.6	2.5	3.2	3.9	18,600	5.5	31,000	9.1	36,000	10.6	1,180	2,116	3,198
	7	7	7	12	33	2.5	2.5	2.5	3.9	18,600	5.5	31,000	9.1	36,000	10.6	1,180	2,116	3,198
	5	5	9	15	34	1.6	1.6	3.2	4.8	18,600	5.5	31,000	9.1	36,000	10.6	1,180	2,116	3,198
	5	5	12	12	34	1.6	1.6	3.9	3.9	18,600	5.5	31,000	9.1	36,000	10.6	1,180	2,116	3,198
	5	7	7	15	34	1.6	2.5	2.5	4.8	18,600	5.5	31,000	9.1	36,000	10.6	1,180	2,116	3,198
	7	9	9	9	34	2.5	3.2	3.2	3.2	18,600	5.5	31,000	9.1	36,000	10.6	1,180	2,116	3,198
	5	5	7	18	35	1.6	1.6	2.5	5.8	18,600	5.5	31,000	9.1	36,000	10.6	1,180	2,116	3,198
	5	9	9	12	35	1.6	3.2	3.2	3.9	18,600	5.5	31,000	9.1	36,000	10.6	1,180	2,116	3,198
	7	7	9	12	35	2.5	2.5	3.2	3.9	18,600	5.5	31,000	9.1	36,000	10.6	1,180	2,116	3,198
	5	7	9	15	36	1.6	2.5	3.2	4.8	18,600	5.5	31,000	9.1	36,000	10.6	1,180	2,116	3,198
	5	7	12	12	36	1.6	2.5	3.9	3.9	18,600	5.5	31,000	9.1	36,000	10.6	1,180	2,116	3,198
	7	7	7	15	36	2.5	2.5	2.5	4.8	18,600	5.5	31,000	9.1	36,000	10.6	1,180	2,116	3,198
	9	9	9	9	36	3.2	3.2	3.2	3.2	18,600	5.5	31,000	9.1	36,000	10.6	1,180	2,116	3,198
	5	5	9	18	37	1.6	1.6	3.2	5.8	18,600	5.5	31,000	9.1	36,000	10.6	1,180	2,116	3,198
	5	5	12	15	37	1.6	1.6	3.9	4.8	18,600	5.5	31,000	9.1	36,000	10.6	1,180	2,116	3,198
	5	7	7	18	37	1.6	2.5	2.5	5.8	18,600	5.5	31,000	9.1	36,000	10.6	1,180	2,116	3,198
	7	9	9	12	37	2.5	3.2	3.2	3.9	18,600	5.5	31,000	9.1	36,000	10.6	1,180	2,116	3,198
	5	9	9	15	38	1.6	3.2	3.2	4.8	18,600	5.5	31,000	9.1	36,000	10.6	1,180	2,116	3,198
	7	7	9	15	38	2.5	2.5	3.2	4.8	18,600	5.5	31,000	9.1	36,000	10.6	1,180	2,116	3,198
	7	7	12	12	38	2.5	2.5	3.9	3.9	18,600	5.5	31,000	9.1	36,000	10.6	1,180	2,116	3,198
5	5	5	24	39	1.6	1.6	1.6	7.4	18,600	5.5	31,000	9.1	36,000	10.6	1,180	2,116	3,198	
5	7	9	18	39	1.6	2.5	3.2	5.8	18,600	5.5	31,000	9.1	36,000	10.6	1,180	2,116	3,198	
5	7	12	15	39	1.6	2.5	3.9	4.8	18,600	5.5	31,000	9.1	36,000	10.6	1,180	2,116	3,198	
9	9	9	12	39	3.2	3.2	3.2	3.9	18,600	5.5	31,000	9.1	36,000	10.6	1,180	2,116	3,198	
7	7	7	18	39	2.5	2.5	2.5	5.8	18,600	5.5	31,000	9.1	36,000	10.6	1,180	2,116	3,198	
7	9	9	15	40	2.5	3.2	3.2	4.8	18,600	5.5	31,000	9.1	36,000	10.6	1,180	2,116	3,198	
7	9	12	12	40	2.5	3.2	3.9	3.9	18,600	5.5	31,000	9.1	36,000	10.6	1,180	2,116	3,198	
5	5	7	24	41	1.6	1.6	2.5	7.4	18,600	5.5	31,000	9.1	36,000	10.6	1,180	2,116	3,198	
5	9	12	15	41	1.6	3.2	3.9	4.8	18,600	5.5	31,000	9.1	36,000	10.6	1,180	2,116	3,198	
5	12	12	12	41	1.6	3.9	3.9	3.9	18,600	5.5	31,000	9.1	36,000	10.6	1,180	2,116	3,198	
7	7	12	15	41	2.5	2.5	3.9	4.8	18,600	5.5	31,000	9.1	36,000	10.6	1,180	2,116	3,198	
7	7	9	18	41	2.5	2.5	3.2	5.8	18,600	5.5	31,000	9.1	36,000	10.6	1,180	2,116	3,198	

Примечание:

1. Производительность охлаждения указана для следующих условий: температура в помещении 27 °Сст / 19 °Свт; температура наружного воздуха 35 °Сст
2. Производительность нагрева указана для следующих условий: температура в помещении 20 °Сст; температура наружного воздуха 7 °Сст / 6 °Свт
3. Общая производительность подключенных внутренних блоков не должна превышать 41 кВт/ч



# MU5M30

Режим работы	Комбинации внутренних блоков (кВт/ч)						Охлаждение													
							Производительность (кВт)					Общая производительность						Потребляемая мощность (Вт)		
							БЛОК А	БЛОК В	БЛОК С	БЛОК D	БЛОК E	Всего	БЛОК А	БЛОК В	БЛОК С	БЛОК D	БЛОК E	Минимум	Номинал	Максимум
1 Блок	5	-	-	-	-	5	1.5	-	-	-	-	Бте/ч	кВт	Бте/ч	кВт	Бте/ч	кВт	416	467	684
	7	-	-	-	-	7	2.1	-	-	-	-	4,500	1.3	5,000	1.5	6,000	1.8	416	551	741
	9	-	-	-	-	9	2.6	-	-	-	-	4,800	1.4	7,000	2.1	8,400	2.5	416	689	961
	12	-	-	-	-	12	3.5	-	-	-	-	5,400	1.6	9,000	2.6	10,800	3.2	551	944	1,287
	15	-	-	-	-	15	4.4	-	-	-	-	7,200	2.1	12,000	3.5	14,400	4.2	661	1,149	1,557
	18	-	-	-	-	18	5.3	-	-	-	-	8,520	2.5	14,200	4.2	17,040	5.0	858	1,482	2,013
2 Блока	5	5	-	-	-	10	1.5	1.5	-	-	-	6,000	1.8	10,000	2.9	12,000	3.5	423	696	952
	5	7	-	-	-	12	1.5	2.1	-	-	-	7,200	2.1	12,000	3.5	14,400	4.2	496	850	1,158
	5	9	-	-	-	14	1.5	2.6	-	-	-	8,400	2.5	14,000	4.1	16,800	4.9	595	1,008	1,370
	7	7	-	-	-	14	2.1	2.1	-	-	-	8,400	2.5	14,000	4.1	16,800	4.9	595	1,008	1,370
	7	9	-	-	-	16	2.1	2.6	-	-	-	9,600	2.8	16,000	4.7	19,200	5.6	670	1,169	1,588
	5	12	-	-	-	17	1.5	3.5	-	-	-	10,200	3.0	17,000	5.0	20,400	6.0	721	1,251	1,715
	5	9	-	-	-	18	2.6	2.6	-	-	-	10,800	3.2	18,000	5.3	21,600	6.3	772	1,334	1,812
	7	12	-	-	-	19	2.1	3.5	-	-	-	11,400	3.3	19,000	5.6	22,800	6.7	798	1,418	1,943
	5	15	-	-	-	20	1.5	4.4	-	-	-	12,000	3.5	20,000	5.9	24,000	7.0	850	1,503	2,042
	9	12	-	-	-	21	2.6	3.5	-	-	-	12,600	3.7	21,000	6.2	25,200	7.4	902	1,589	2,230
	7	15	-	-	-	22	2.1	4.4	-	-	-	13,200	3.9	22,000	6.4	26,400	7.7	955	1,647	2,276
	5	18	-	-	-	23	1.5	5.3	-	-	-	13,800	4.0	23,000	6.7	27,600	8.1	981	1,734	2,586
	9	15	-	-	-	24	2.6	4.4	-	-	-	14,400	4.2	24,000	7.0	28,800	8.4	1,034	1,823	2,756
	12	12	-	-	-	24	3.5	3.5	-	-	-	14,400	4.2	24,000	7.0	28,800	8.4	1,034	1,823	2,756
	7	18	-	-	-	25	2.1	5.3	-	-	-	15,000	4.4	25,000	7.3	30,000	8.8	1,088	1,948	2,993
	9	18	-	-	-	27	2.6	5.3	-	-	-	16,200	4.7	27,000	7.9	32,400	9.5	1,169	2,212	3,442
	12	15	-	-	-	27	3.5	4.4	-	-	-	16,200	4.7	27,000	7.9	32,400	9.5	1,169	2,212	3,442
	5	24	-	-	-	29	1.5	7.0	-	-	-	17,400	5.1	29,000	8.5	33,000	9.7	1,279	2,512	3,579
	12	18	-	-	-	30	3.5	5.3	-	-	-	18,000	5.3	30,000	8.8	33,000	9.7	1,334	2,672	3,579
	15	15	-	-	-	30	4.4	4.4	-	-	-	18,000	5.3	30,000	8.8	33,000	9.7	1,334	2,672	3,579
	7	24	-	-	-	31	2.1	7.0	-	-	-	18,000	5.3	30,000	8.8	33,000	9.7	1,334	2,672	3,579
	9	24	-	-	-	33	2.6	7.0	-	-	-	18,000	5.3	30,000	8.8	33,000	9.7	1,334	2,672	3,579
	15	18	-	-	-	33	4.4	5.3	-	-	-	18,000	5.3	30,000	8.8	33,000	9.7	1,334	2,672	3,579
	18	18	-	-	-	36	5.3	5.3	-	-	-	18,000	5.3	30,000	8.8	33,000	9.7	1,334	2,672	3,579
12	24	-	-	-	36	3.5	7.0	-	-	-	18,000	5.3	30,000	8.8	33,000	9.7	1,334	2,672	3,579	
15	24	-	-	-	39	4.4	7.0	-	-	-	18,000	5.3	30,000	8.8	33,000	9.7	1,334	2,672	3,579	
18	24	-	-	-	42	5.3	7.0	-	-	-	18,000	5.3	30,000	8.8	33,000	9.7	1,334	2,672	3,579	
24	24	-	-	-	48	7.0	7.0	-	-	-	18,000	5.3	30,000	8.8	33,000	9.7	1,334	2,672	3,579	
3 Блока	5	5	5	-	-	15	1.5	1.5	1.5	-	-	9,000	2.6	15,000	4.4	18,000	5.3	583	1,023	1,405
	5	5	7	-	-	17	1.5	1.5	2.1	-	-	10,200	3.0	17,000	5.0	20,400	6.0	678	1,176	1,613
	5	5	9	-	-	19	1.5	1.5	2.6	-	-	11,400	3.3	19,000	5.6	22,800	6.7	750	1,333	1,826
	5	7	7	-	-	19	1.5	2.1	2.1	-	-	11,400	3.3	19,000	5.6	22,800	6.7	750	1,333	1,826
	5	7	9	-	-	21	1.5	2.1	2.6	-	-	12,600	3.7	21,000	6.2	25,200	7.4	848	1,494	2,096
	7	7	7	-	-	21	2.1	2.1	2.1	-	-	12,600	3.7	21,000	6.2	25,200	7.4	848	1,494	2,096
	5	5	12	-	-	22	1.5	1.5	3.5	-	-	13,200	3.9	22,000	6.4	26,400	7.7	897	1,548	2,234
	5	9	9	-	-	23	1.5	2.6	2.6	-	-	13,800	4.0	23,000	6.7	27,600	8.1	922	1,630	2,441
	7	7	9	-	-	23	2.1	2.1	2.6	-	-	13,800	4.0	23,000	6.7	27,600	8.1	922	1,630	2,441
	5	7	12	-	-	24	1.5	2.1	3.5	-	-	14,400	4.2	24,000	7.0	28,800	8.4	972	1,714	2,617
	5	5	15	-	-	25	1.5	1.5	4.4	-	-	15,000	4.4	25,000	7.3	30,000	8.8	1,023	1,831	2,865
	7	9	9	-	-	25	2.1	2.6	2.6	-	-	15,000	4.4	25,000	7.3	30,000	8.8	1,023	1,831	2,865
	5	9	12	-	-	26	1.5	2.6	3.5	-	-	15,600	4.6	26,000	7.6	31,200	9.1	1,073	1,953	3,063
	7	7	12	-	-	26	2.1	2.1	3.5	-	-	15,600	4.6	26,000	7.6	31,200	9.1	1,073	1,953	3,063
	5	7	15	-	-	27	1.5	2.1	4.4	-	-	16,200	4.7	27,000	7.9	32,400	9.5	1,099	2,079	3,342
	9	9	9	-	-	27	2.6	2.6	2.6	-	-	16,200	4.7	27,000	7.9	32,400	9.5	1,099	2,079	3,342
	7	9	12	-	-	28	2.1	2.6	3.5	-	-	16,800	4.9	28,000	8.2	33,600	9.8	1,150	2,231	3,564
	5	5	18	-	-	28	1.5	1.5	5.3	-	-	16,800	4.9	28,000	8.2	33,600	9.8	1,150	2,231	3,564
	5	9	15	-	-	29	1.5	2.6	4.4	-	-	17,400	5.1	29,000	8.5	33,600	9.8	1,202	2,390	3,564
	5	12	12	-	-	29	1.5	3.5	3.5	-	-	17,400	5.1	29,000	8.5	33,600	9.8	1,202	2,390	3,564
	7	7	15	-	-	29	2.1	2.1	4.4	-	-	17,400	5.1	29,000	8.5	33,600	9.8	1,202	2,390	3,564
	5	7	18	-	-	30	1.5	2.1	5.3	-	-	18,000	5.3	30,000	8.8	33,600	9.8	1,254	2,558	3,564
	9	9	12	-	-	30	2.6	2.6	3.5	-	-	18,000	5.3	30,000	8.8	33,600	9.8	1,254	2,558	3,564
	7	9	15	-	-	31	2.1	2.6	4.4	-	-	18,000	5.3	30,000	8.8	33,600	9.8	1,254	2,558	3,564
	7	12	12	-	-	31	2.1	3.5	3.5	-	-	18,000	5.3	30,000	8.8	33,600	9.8	1,254	2,558	3,564
	5	12	15	-	-	32	1.5	3.5	4.4	-	-	18,000	5.3	30,000	8.8	33,600	9.8	1,254	2,558	3,564
	5	9	18	-	-	32	1.5	2.6	5.3	-	-	18,000	5.3	30,000	8.8	33,600	9.8	1,254	2,558	3,564
	7	7	18	-	-	32	2.1	2.1	5.3	-	-	18,000	5.3	30,000	8.8	33,600	9.8	1,254	2,558	3,564
	9	9	15	-	-	33	2.6	2.6	4.4	-	-	18,000	5.3	30,000	8.8	33,600	9.8	1,254	2,558	3,564
	9	12	12	-	-	33	2.6	3.5	3.5	-	-	18,000	5.3	30,000	8.8	33,600	9.8	1,254	2,558	3,564
	7	9	18	-	-	34	2.1	2.6	5.3	-	-	18,000	5.3	30,000	8.8	33,600	9.8	1,254	2,558	3,564
	7	12	15	-	-	34	2.1	3.5	4.4	-	-	18,000	5.3	30,000	8.8	33,600	9.8	1,254	2,558	3,564
	5	5	24	-	-	34	1.5	1.5	7.0	-	-	18,000	5.3	30,000	8.8	33,600	9.8	1,254	2,558	3,564
	5	12	18	-	-	35	1.5	3.5	5.3	-	-	18,000	5.3	30,000	8.8	33,600	9.8	1,254	2,558	3,564
	5	15	15	-	-	35	1.5	4.4	4.4	-	-	18,000	5.3	30,000	8.8	33,600	9.8	1,254	2,558	3,564
	5	7	24	-	-	36	1.5	2.1	7.0	-	-	18,000	5.3	30,000	8.8	33,600	9.8	1,254	2,558	3,564

Режим работы	Комбинации внутренних блоков (кВт/ч)						Охлаждение													
							Производительность (кВт)					Общая производительность						Потребляемая мощность (Вт)		
	БЛОК А	БЛОК В	БЛОК С	БЛОК D	БЛОК E	Всего	БЛОК А	БЛОК В	БЛОК С	БЛОК D	БЛОК E	Бте/ч	кВт	Бте/ч	кВт	Бте/ч	кВт	Минимум	Номинал	Максимум
3 Блока	7	18	18	-	-	43	2.1	5.3	5.3	-	-	18,000	5.3	30,000	8.8	33,600	9.8	1,254	2,558	3,564
	7	12	24	-	-	43	2.1	3.5	7.0	-	-	18,000	5.3	30,000	8.8	33,600	9.8	1,254	2,558	3,564
	5	15	24	-	-	44	1.5	4.4	7.0	-	-	18,000	5.3	30,000	8.8	33,600	9.8	1,254	2,558	3,564
	9	18	18	-	-	45	2.6	5.3	5.3	-	-	18,000	5.3	30,000	8.8	33,600	9.8	1,254	2,558	3,564
	9	12	24	-	-	45	2.6	3.5	7.0	-	-	18,000	5.3	30,000	8.8	33,600	9.8	1,254	2,558	3,564
	12	15	18	-	-	45	3.5	4.4	5.3	-	-	18,000	5.3	30,000	8.8	33,600	9.8	1,254	2,558	3,564
	15	15	15	-	-	45	4.4	4.4	4.4	-	-	18,000	5.3	30,000	8.8	33,600	9.8	1,254	2,558	3,564
	7	15	24	-	-	46	2.1	4.4	7.0	-	-	18,000	5.3	30,000	8.8	33,600	9.8	1,254	2,558	3,564
	5	18	24	-	-	47	1.5	5.3	7.0	-	-	18,000	5.3	30,000	8.8	33,600	9.8	1,254	2,558	3,564
	9	15	24	-	-	48	2.6	4.4	7.0	-	-	18,000	5.3	30,000	8.8	33,600	9.8	1,254	2,558	3,564
	12	18	18	-	-	48	3.5	5.3	5.3	-	-	18,000	5.3	30,000	8.8	33,600	9.8	1,254	2,558	3,564
	12	12	24	-	-	48	3.5	3.5	7.0	-	-	18,000	5.3	30,000	8.8	33,600	9.8	1,254	2,558	3,564
	15	15	18	-	-	48	4.4	4.4	5.3	-	-	18,000	5.3	30,000	8.8	33,600	9.8	1,254	2,558	3,564
	5	5	5	5	5	20	1.5	1.5	1.5	1.5	1.5	12,000	3.5	20,000	5.9	24,000	7.0	759	1,342	1,823
	5	5	5	7	-	22	1.5	1.5	1.5	2.1	-	13,200	3.9	22,000	6.4	26,400	7.7	853	1,471	2,122
5	5	5	9	-	24	1.5	1.5	1.5	2.6	-	14,400	4.2	24,000	7.0	28,800	8.4	924	1,628	2,436	
5	5	7	7	-	24	1.5	1.5	2.1	2.1	-	14,400	4.2	24,000	7.0	28,800	8.4	924	1,628	2,436	
5	5	7	9	-	26	1.5	1.5	2.1	2.6	-	15,600	4.6	26,000	7.6	31,200	9.1	1,020	1,855	2,772	
5	7	7	7	-	26	1.5	2.1	2.1	2.1	-	15,600	4.6	26,000	7.6	31,200	9.1	1,020	1,855	2,772	
5	5	5	12	-	27	1.5	1.5	1.5	3.5	-	16,200	4.7	27,000	7.9	32,400	9.5	1,044	1,975	2,976	
5	5	9	9	-	28	1.5	1.5	2.6	2.6	-	16,800	4.9	28,000	8.2	33,600	9.8	1,093	2,094	3,136	
5	7	7	9	-	28	1.5	2.1	2.1	2.6	-	16,800	4.9	28,000	8.2	33,600	9.8	1,093	2,094	3,136	
7	7	7	7	-	28	2.1	2.1	2.1	2.1	-	16,800	4.9	28,000	8.2	33,600	9.8	1,093	2,094	3,136	
5	5	7	12	-	29	1.5	1.5	2.1	3.5	-	17,400	5.1	29,000	8.5	34,800	10.2	1,142	2,216	3,357	
5	5	5	15	-	30	1.5	1.5	1.5	4.4	-	18,000	5.3	30,000	8.8	36,000	10.6	1,191	2,344	3,588	
5	7	9	9	-	30	1.5	2.1	2.6	2.6	-	18,000	5.3	30,000	8.8	36,000	10.6	1,191	2,344	3,588	
7	7	7	9	-	30	2.1	2.1	2.1	2.6	-	18,000	5.3	30,000	8.8	36,000	10.6	1,191	2,344	3,588	
5	5	9	12	-	31	1.5	1.5	2.6	3.5	-	18,000	5.3	30,000	8.8	36,000	10.6	1,191	2,344	3,588	
5	7	7	12	-	31	1.5	2.1	2.1	3.5	-	18,000	5.3	30,000	8.8	36,000	10.6	1,191	2,344	3,588	
5	5	7	15	-	32	1.5	1.5	2.1	4.4	-	18,000	5.3	30,000	8.8	36,000	10.6	1,191	2,344	3,588	
7	7	9	9	-	32	2.1	2.1	2.6	2.6	-	18,000	5.3	30,000	8.8	36,000	10.6	1,191	2,344	3,588	
5	9	9	9	-	32	1.5	2.6	2.6	2.6	-	18,000	5.3	30,000	8.8	36,000	10.6	1,191	2,344	3,588	
5	5	5	18	-	33	1.5	1.5	1.5	5.3	-	18,000	5.3	30,000	8.8	36,000	10.6	1,191	2,344	3,588	
5	7	9	12	-	33	1.5	2.1	2.6	3.5	-	18,000	5.3	30,000	8.8	36,000	10.6	1,191	2,344	3,588	
7	7	7	12	-	33	2.1	2.1	2.1	3.5	-	18,000	5.3	30,000	8.8	36,000	10.6	1,191	2,344	3,588	
5	5	9	15	-	34	1.5	1.5	2.6	4.4	-	18,000	5.3	30,000	8.8	36,000	10.6	1,191	2,344	3,588	
5	5	12	12	-	34	1.5	1.5	3.5	3.5	-	18,000	5.3	30,000	8.8	36,000	10.6	1,191	2,344	3,588	
5	7	7	15	-	34	1.5	2.1	2.1	4.4	-	18,000	5.3	30,000	8.8	36,000	10.6	1,191	2,344	3,588	
7	9	9	9	-	34	2.1	2.6	2.6	2.6	-	18,000	5.3	30,000	8.8	36,000	10.6	1,191	2,344	3,588	
5	5	7	18	-	35	1.5	1.5	2.1	5.3	-	18,000	5.3	30,000	8.8	36,000	10.6	1,191	2,344	3,588	
5	9	9	12	-	35	1.5	2.6	2.6	3.5	-	18,000	5.3	30,000	8.8	36,000	10.6	1,191	2,344	3,588	
7	7	9	12	-	35	2.1	2.1	2.6	3.5	-	18,000	5.3	30,000	8.8	36,000	10.6	1,191	2,344	3,588	
5	7	9	15	-	36	1.5	2.1	2.6	4.4	-	18,000	5.3	30,000	8.8	36,000	10.6	1,191	2,344	3,588	
5	7	12	12	-	36	1.5	2.1	3.5	3.5	-	18,000	5.3	30,000	8.8	36,000	10.6	1,191	2,344	3,588	
7	7	7	15	-	36	2.1	2.1	2.1	4.4	-	18,000	5.3	30,000	8.8	36,000	10.6	1,191	2,344	3,588	
9	9	9	9	-	36	2.6	2.6	2.6	2.6	-	18,000	5.3	30,000	8.8	36,000	10.6	1,191	2,344	3,588	
5	5	9	18	-	37	1.5	1.5	2.6	5.3	-	18,000	5.3	30,000	8.8	36,000	10.6	1,191	2,344	3,588	
5	5	12	15	-	37	1.5	1.5	3.5	4.4	-	18,000	5.3	30,000	8.8	36,000	10.6	1,191	2,344	3,588	
5	7	7	18	-	37	1.5	2.1	2.1	5.3	-	18,000	5.3	30,000	8.8	36,000	10.6	1,191	2,344	3,588	
7	9	9	12	-	37	2.1	2.6	2.6	3.5	-	18,000	5.3	30,000	8.8	36,000	10.6	1,191	2,344	3,588	
5	9	9	15	-	38	1.5	2.6	2.6	4.4	-	18,000	5.3	30,000	8.8	36,000	10.6	1,191	2,344	3,588	
7	7	9	15	-	38	2.1	2.1	2.6	4.4	-	18,000	5.3	30,000	8.8	36,000	10.6	1,191	2,344	3,588	
7	7	12	12	-	38	2.1	2.1	3.5	3.5	-	18,000	5.3	30,000	8.8	36,000	10.6	1,191	2,344	3,588	
5	5	5	24	-	39	1.5	1.5	1.5	7.0	-	18,000	5.3	30,000	8.8	36,000	10.6	1,191	2,344	3,588	
5	7	9	18	-	39	1.5	2.1	2.6	5.3	-	18,000	5.3	30,000	8.8	36,000	10.6	1,191	2,344	3,588	
5	7	12	15	-	39	1.5	2.1	3.5	4.4	-	18,000	5.3	30,000	8.8	36,000	10.6	1,191	2,344	3,588	
9	9	9	12	-	39	2.6	2.6	2.6	3.5	-	18,000	5.3	30,000	8.8	36,000	10.6	1,191	2,344	3,588	
7	7	7	18	-	39	2.1	2.1	2.1	5.3	-	18,000	5.3	30,000	8.8	36,000	10.6	1,191	2,344	3,588	
7	9	9	15	-	40	2.1	2.6	2.6	4.4	-	18,000	5.3	30,000	8.8	36,000	10.6	1,191	2,344	3,588	
7	9	12	12	-	40	2.1	2.6	3.5	3.5	-	18,000	5.3	30,000	8.8	36,000	10.6	1,191	2,344	3,588	
5	5	7	24	-	41	1.5	1.5	2.1	7.0	-	18,000	5.3	30,000	8.8	36,000	10.6	1,191	2,344	3,588	
5	9	12	15	-	41	1.5	2.6	3.5	4.4	-	18,000	5.3	30,000	8.8	36,000	10.6	1,191	2,344	3,588	
5	12	12	12	-	41	1.5	3.5	3.5	3.5	-	18,000	5.3	30,000	8.8	36,000	10.6	1,191	2,344	3,588	
7	7	12	15	-	41	2.1	2.1	3.5	4.4	-	18,000	5.3	30,000	8.8	36,000	10.6	1,191	2,344	3,588	
7	7	9	18	-	41	2.1	2.1	2.6	5.3	-	18,000	5.3	30,000	8.8	36,000	10.6	1,191	2,344	3,588	
5	7	15	15	-	42	1.5	2.1	4.4	4.4	-	18,000	5.3	30,000	8.8	36,000	10.6	1,191	2,344	3,588	
9	9	9	15	-	42	2.6	2.6	2.6	4.4	-	18,000	5.3	30,000	8.8	36,000	10.6	1,191	2,344	3,588	
9	9	12	12	-	42	2.6	2.6	3.5	3.5	-	18,000	5.3	30,000	8.8	36,000	10.6	1,191	2,344	3,588	
7	9	12	15	-	43	2.1	2.6	3.5	4.4	-	18,000	5.3	30,000	8.8	36,000	10.6	1,191	2,344	3,588	
7	12	12	12	-	43	2.1	3.5	3.5	3.5	-	18,000	5.3	30,000	8.8	36,000	10.6	1,191	2,344	3,588	
7	9	9	18	-	43	2.1	2.6	2.6	5.3	-	18,000	5.3	30,000	8.8	36,000	10.6	1,191	2,344	3,588	
5	9	15	15	-	44	1.5	2.6	4.4	4.4	-	18,000	5.3	30,000	8.8	36,000	10.6	1,191	2,344	3,588	
7	7	12	18	-	44	2.1	2.1													

# MU5M30

Режим работы	Комбинации внутренних блоков (кВт/ч)						Охлаждение													
							Производительность (кВт)					Общая производительность						Потребляемая мощность (Вт)		
							БЛОК А	БЛОК В	БЛОК С	БЛОК D	БЛОК E	Минимум	Номинал	Максимум	Минимум	Номинал	Максимум			
	БЛОК А	БЛОК В	БЛОК С	БЛОК D	БЛОК E	Всего	БЛОК А	БЛОК В	БЛОК С	БЛОК D	БЛОК E	Бте/ч	кВт	Бте/ч	кВт	Бте/ч	кВт	Минимум	Номинал	Максимум
5	5	5	5	5	25	1.5	1.5	1.5	1.5	1.5	15,000	4.4	25,000	7.3	30,000	8.8	949	1,711	2,527	
5	5	5	5	7	27	1.5	1.5	1.5	1.5	2.1	16,200	4.7	27,000	7.9	32,400	9.5	1,022	1,919	2,906	
5	5	5	5	9	29	1.5	1.5	1.5	1.5	2.6	17,400	5.1	29,000	8.5	34,800	10.2	1,120	2,141	3,324	
5	5	5	7	7	29	1.5	1.5	1.5	2.1	2.1	17,400	5.1	29,000	8.5	34,800	10.2	1,120	2,141	3,324	
5	5	5	7	9	31	1.5	1.5	1.5	2.1	2.6	18,000	5.3	30,000	8.8	36,000	10.6	1,170	2,256	3,582	
5	5	7	7	7	31	1.5	1.5	2.1	2.1	2.1	18,000	5.3	30,000	8.8	36,000	10.6	1,170	2,256	3,582	
5	5	5	5	12	32	1.5	1.5	1.5	1.5	3.5	18,000	5.3	30,000	8.8	36,000	10.6	1,170	2,256	3,582	
5	5	5	9	9	33	1.5	1.5	1.5	2.6	2.6	18,000	5.3	30,000	8.8	36,000	10.6	1,170	2,256	3,582	
5	5	7	7	9	33	1.5	1.5	2.1	2.1	2.6	18,000	5.3	30,000	8.8	36,000	10.6	1,170	2,256	3,582	
5	7	7	7	7	33	1.5	2.1	2.1	2.1	2.1	18,000	5.3	30,000	8.8	36,000	10.6	1,170	2,256	3,582	
5	5	5	7	12	34	1.5	1.5	1.5	2.1	3.5	18,000	5.3	30,000	8.8	36,000	10.6	1,170	2,256	3,582	
5	5	5	5	15	35	1.5	1.5	1.5	1.5	4.4	18,000	5.3	30,000	8.8	36,000	10.6	1,170	2,256	3,582	
5	7	7	7	9	35	1.5	2.1	2.1	2.1	2.6	18,000	5.3	30,000	8.8	36,000	10.6	1,170	2,256	3,582	
7	7	7	7	7	35	2.1	2.1	2.1	2.1	2.1	18,000	5.3	30,000	8.8	36,000	10.6	1,170	2,256	3,582	
5	5	5	9	12	36	1.5	1.5	1.5	2.6	3.5	18,000	5.3	30,000	8.8	36,000	10.6	1,170	2,256	3,582	
5	5	7	7	12	36	1.5	1.5	2.1	2.1	3.5	18,000	5.3	30,000	8.8	36,000	10.6	1,170	2,256	3,582	
5	5	5	7	15	37	1.5	1.5	1.5	2.1	4.4	18,000	5.3	30,000	8.8	36,000	10.6	1,170	2,256	3,582	
5	5	9	9	9	37	1.5	1.5	2.6	2.6	2.6	18,000	5.3	30,000	8.8	36,000	10.6	1,170	2,256	3,582	
5	7	7	9	9	37	1.5	2.1	2.1	2.6	2.6	18,000	5.3	30,000	8.8	36,000	10.6	1,170	2,256	3,582	
7	7	7	7	9	37	2.1	2.1	2.1	2.1	2.6	18,000	5.3	30,000	8.8	36,000	10.6	1,170	2,256	3,582	
5	5	5	5	18	38	1.5	1.5	1.5	1.5	5.3	18,000	5.3	30,000	8.8	36,000	10.6	1,170	2,256	3,582	
5	7	7	7	12	38	1.5	2.1	2.1	2.1	3.5	18,000	5.3	30,000	8.8	36,000	10.6	1,170	2,256	3,582	
5	5	5	9	15	39	1.5	1.5	1.5	2.6	4.4	18,000	5.3	30,000	8.8	36,000	10.6	1,170	2,256	3,582	
5	5	5	12	12	39	1.5	1.5	1.5	3.5	3.5	18,000	5.3	30,000	8.8	36,000	10.6	1,170	2,256	3,582	
5	5	7	7	15	39	1.5	1.5	2.1	2.1	4.4	18,000	5.3	30,000	8.8	36,000	10.6	1,170	2,256	3,582	
7	7	7	9	9	39	2.1	2.1	2.1	2.6	2.6	18,000	5.3	30,000	8.8	36,000	10.6	1,170	2,256	3,582	
5	7	9	9	9	39	1.5	2.1	2.6	2.6	2.6	18,000	5.3	30,000	8.8	36,000	10.6	1,170	2,256	3,582	
5	5	5	7	18	40	1.5	1.5	1.5	2.1	5.3	18,000	5.3	30,000	8.8	36,000	10.6	1,170	2,256	3,582	
5	5	9	9	12	40	1.5	1.5	2.6	2.6	3.5	18,000	5.3	30,000	8.8	36,000	10.6	1,170	2,256	3,582	
5	7	7	9	12	40	1.5	2.1	2.1	2.6	3.5	18,000	5.3	30,000	8.8	36,000	10.6	1,170	2,256	3,582	
7	7	7	7	12	40	2.1	2.1	2.1	2.1	3.5	18,000	5.3	30,000	8.8	36,000	10.6	1,170	2,256	3,582	
5	5	7	9	15	41	1.5	1.5	2.1	2.6	4.4	18,000	5.3	30,000	8.8	36,000	10.6	1,170	2,256	3,582	
5	7	7	7	15	41	1.5	2.1	2.1	2.1	4.4	18,000	5.3	30,000	8.8	36,000	10.6	1,170	2,256	3,582	
5	9	9	9	9	41	1.5	2.6	2.6	2.6	2.6	18,000	5.3	30,000	8.8	36,000	10.6	1,170	2,256	3,582	
7	7	9	9	9	41	2.1	2.1	2.6	2.6	2.6	18,000	5.3	30,000	8.8	36,000	10.6	1,170	2,256	3,582	
5	5	5	9	18	42	1.5	1.5	1.5	2.6	5.3	18,000	5.3	30,000	8.8	36,000	10.6	1,170	2,256	3,582	
5	5	5	12	15	42	1.5	1.5	1.5	3.5	4.4	18,000	5.3	30,000	8.8	36,000	10.6	1,170	2,256	3,582	
5	5	7	7	18	42	1.5	1.5	2.1	2.1	5.3	18,000	5.3	30,000	8.8	36,000	10.6	1,170	2,256	3,582	
5	7	9	9	12	42	1.5	2.1	2.6	2.6	3.5	18,000	5.3	30,000	8.8	36,000	10.6	1,170	2,256	3,582	
7	7	7	9	12	42	2.1	2.1	2.1	2.6	3.5	18,000	5.3	30,000	8.8	36,000	10.6	1,170	2,256	3,582	
5	5	9	9	15	43	1.5	1.5	2.6	2.6	4.4	18,000	5.3	30,000	8.8	36,000	10.6	1,170	2,256	3,582	
5	7	7	9	15	43	1.5	2.1	2.1	2.6	4.4	18,000	5.3	30,000	8.8	36,000	10.6	1,170	2,256	3,582	
5	7	7	12	12	43	1.5	2.1	2.1	3.5	3.5	18,000	5.3	30,000	8.8	36,000	10.6	1,170	2,256	3,582	
7	7	7	7	15	43	2.1	2.1	2.1	2.1	4.4	18,000	5.3	30,000	8.8	36,000	10.6	1,170	2,256	3,582	
7	9	9	9	9	43	2.1	2.6	2.6	2.6	2.6	18,000	5.3	30,000	8.8	36,000	10.6	1,170	2,256	3,582	
5	5	7	12	15	44	1.5	1.5	2.1	3.5	4.4	18,000	5.3	30,000	8.8	36,000	10.6	1,170	2,256	3,582	
5	5	5	5	24	44	1.5	1.5	1.5	1.5	7.0	18,000	5.3	30,000	8.8	36,000	10.6	1,170	2,256	3,582	
5	7	7	7	18	44	1.5	2.1	2.1	2.1	5.3	18,000	5.3	30,000	8.8	36,000	10.6	1,170	2,256	3,582	
5	9	9	9	12	44	1.5	2.6	2.6	2.6	3.5	18,000	5.3	30,000	8.8	36,000	10.6	1,170	2,256	3,582	
7	7	9	9	12	44	2.1	2.1	2.6	2.6	3.5	18,000	5.3	30,000	8.8	36,000	10.6	1,170	2,256	3,582	
5	5	5	12	18	45	1.5	1.5	1.5	3.5	5.3	18,000	5.3	30,000	8.8	36,000	10.6	1,170	2,256	3,582	
5	5	5	15	15	45	1.5	1.5	1.5	4.4	4.4	18,000	5.3	30,000	8.8	36,000	10.6	1,170	2,256	3,582	
5	7	9	9	15	45	1.5	2.1	2.6	2.6	4.4	18,000	5.3	30,000	8.8	36,000	10.6	1,170	2,256	3,582	
5	7	9	12	12	45	1.5	2.1	2.6	3.5	3.5	18,000	5.3	30,000	8.8	36,000	10.6	1,170	2,256	3,582	
7	7	7	9	15	45	2.1	2.1	2.1	2.6	4.4	18,000	5.3	30,000	8.8	36,000	10.6	1,170	2,256	3,582	
7	7	7	12	12	45	2.1	2.1	2.1	3.5	3.5	18,000	5.3	30,000	8.8	36,000	10.6	1,170	2,256	3,582	
9	9	9	9	9	45	2.6	2.6	2.6	2.6	2.6	18,000	5.3	30,000	8.8	36,000	10.6	1,170	2,256	3,582	
5	5	5	7	24	46	1.5	1.5	1.5	2.1	7.0	18,000	5.3	30,000	8.8	36,000	10.6	1,170	2,256	3,582	
5	5	9	9	18	46	1.5	1.5	2.6	2.6	5.3	18,000	5.3	30,000	8.8	36,000	10.6	1,170	2,256	3,582	
5	5	9	12	15	46	1.5	1.5	2.6	3.5	4.4	18,000	5.3	30,000	8.8	36,000	10.6	1,170	2,256	3,582	
5	5	12	12	12	46	1.5	1.5	3.5	3.5	3.5	18,000	5.3	30,000	8.8	36,000	10.6	1,170	2,256	3,582	
5	7	7	9	18	46	1.5	2.1	2.1	2.6	5.3	18,000	5.3	30,000	8.8	36,000	10.6	1,170	2,256	3,582	
5	7	7	12	15	46	1.5	2.1	2.1	3.5	4.4	18,000	5.3	30,000	8.8	36,000	10.6	1,170	2,256	3,582	
7	7	7	7	18	46	2.1	2.1	2.1	2.1	5.3	18,000	5.3	30,000	8.8	36,000	10.6	1,170	2,256	3,582	
7	9	9	9	12	46	2.1	2.6	2.6	2.6	3.5	18,000	5.3	30,000	8.8	36,000	10.6	1,170	2,256	3,582	
5	5	7	15	15	47	1.5	1.5	2.1	4.4	4.4	18,000	5.3	30,000	8.8	36,000	10.6	1,170	2,256	3,582	
5	9	9	9	15	47	1.5	2.6	2.6	2.6	4.4	18,000	5.3	30,000	8.8	36,000	10.6	1,170	2,256	3,582	
5	9	9	12	12	47	1.5	2.6	2.6	3.5	3.5	18,000	5.3	30,000	8.8	36,000	10.6	1,170	2,256	3,582	
7	7	9	9	15	47	2.1	2.1	2.6	2.6	4.4	18,000	5.3	30,000	8.8	36,000	10.6	1,170	2,256	3,582	
7	7	9	12	12	47	2.1	2.1	2.6	3.5	3.5	18,000	5.3	30,000							

Режим работы	Комбинации внутренних блоков (кВт/ч)						Нагрев													
							Производительность (кВт)					Общая производительность						Потребляемая мощность (Вт)		
							БЛОК А	БЛОК В	БЛОК С	БЛОК D	БЛОК E	Всего	БЛОК А	БЛОК В	БЛОК С	БЛОК D	БЛОК E	Минимум		Номинал
Бте/ч	кВт	Бте/ч	кВт	Бте/ч	кВт	Бте/ч												кВт	Бте/ч	кВт
1 Блок	5	-	-	-	-	5	1.6	-	-	-	-	5,000	1.5	5,500	1.6	6,325	1.9	610	610	747
	7	-	-	-	-	7	2.5	-	-	-	-	5,500	1.6	8,400	2.5	9,660	2.8	610	665	862
	9	-	-	-	-	9	3.2	-	-	-	-	6,480	1.9	10,800	3.2	12,420	3.6	610	864	1,126
	12	-	-	-	-	12	3.9	-	-	-	-	7,920	2.3	13,200	3.9	15,180	4.4	610	1,067	1,399
	15	-	-	-	-	15	4.8	-	-	-	-	9,900	2.9	16,500	4.8	18,975	5.6	778	1,337	1,823
	18	-	-	-	-	18	5.8	-	-	-	-	11,880	3.5	19,800	5.8	22,770	6.7	950	1,649	2,230
24	-	-	-	-	24	7.4	-	-	-	-	15,240	4.5	25,400	7.4	26,670	7.8	1,246	2,172	2,654	
2 Блок	5	5	-	-	-	10	1.6	1.6	-	-	-	7,200	2.1	12,000	3.5	14,400	4.2	471	808	1,130
	5	7	-	-	-	12	1.6	2.5	-	-	-	8,640	2.5	14,400	4.2	17,280	5.1	566	983	1,397
	5	9	-	-	-	14	1.6	3.2	-	-	-	10,080	3.0	16,800	4.9	20,160	5.9	685	1,163	1,643
	7	7	-	-	-	14	2.5	2.5	-	-	-	10,080	3.0	16,800	4.9	20,160	5.9	685	1,163	1,643
	7	9	-	-	-	16	2.5	3.2	-	-	-	11,520	3.4	19,200	5.6	23,040	6.8	783	1,348	1,928
	5	12	-	-	-	17	1.6	3.9	-	-	-	12,240	3.6	20,400	6.0	24,480	7.2	832	1,456	2,057
	9	9	-	-	-	18	3.2	3.2	-	-	-	12,960	3.8	21,600	6.3	25,920	7.6	882	1,537	2,189
	7	12	-	-	-	19	2.5	3.9	-	-	-	13,680	4.0	22,800	6.7	27,360	8.0	932	1,648	2,323
	5	15	-	-	-	20	1.6	4.8	-	-	-	14,400	4.2	24,000	7.0	28,800	8.4	983	1,732	2,459
	9	12	-	-	-	21	3.2	3.9	-	-	-	15,120	4.4	25,200	7.4	30,240	8.9	1,034	1,846	2,644
	7	15	-	-	-	22	2.5	4.8	-	-	-	15,840	4.6	26,400	7.7	31,680	9.3	1,085	1,932	2,877
	5	18	-	-	-	23	1.6	5.8	-	-	-	16,560	4.9	27,600	8.1	33,120	9.7	1,163	2,049	3,200
	9	15	-	-	-	24	3.2	4.8	-	-	-	17,280	5.1	28,800	8.4	34,560	10.1	1,215	2,138	3,554
	12	12	-	-	-	24	3.9	3.9	-	-	-	17,280	5.1	28,800	8.4	34,560	10.1	1,215	2,138	3,554
	7	18	-	-	-	25	2.5	5.8	-	-	-	18,000	5.3	30,000	8.8	34,560	10.1	1,268	2,267	3,554
	9	18	-	-	-	27	3.2	5.8	-	-	-	19,440	5.7	32,400	9.5	34,560	10.1	1,374	2,639	3,554
	12	15	-	-	-	27	3.9	4.8	-	-	-	19,440	5.7	32,400	9.5	34,560	10.1	1,374	2,639	3,554
	5	24	-	-	-	29	1.6	7.4	-	-	-	20,700	6.1	34,500	10.1	34,560	10.1	1,483	3,091	3,554
	12	18	-	-	-	30	3.9	5.8	-	-	-	20,700	6.1	34,500	10.1	34,560	10.1	1,483	3,091	3,554
	15	15	-	-	-	30	4.8	4.8	-	-	-	20,700	6.1	34,500	10.1	34,560	10.1	1,483	3,091	3,554
	7	24	-	-	-	31	2.5	7.4	-	-	-	20,700	6.1	34,500	10.1	34,560	10.1	1,483	3,091	3,554
	9	24	-	-	-	33	3.2	7.4	-	-	-	20,700	6.1	34,500	10.1	34,560	10.1	1,483	3,091	3,554
	15	18	-	-	-	33	4.8	5.8	-	-	-	20,700	6.1	34,500	10.1	34,560	10.1	1,483	3,091	3,554
	18	18	-	-	-	36	5.8	5.8	-	-	-	20,700	6.1	34,500	10.1	34,560	10.1	1,483	3,091	3,554
12	24	-	-	-	36	3.9	7.4	-	-	-	20,700	6.1	34,500	10.1	34,560	10.1	1,483	3,091	3,554	
15	24	-	-	-	39	4.8	7.4	-	-	-	20,700	6.1	34,500	10.1	34,560	10.1	1,483	3,091	3,554	
18	24	-	-	-	42	5.8	7.4	-	-	-	20,700	6.1	34,500	10.1	34,560	10.1	1,483	3,091	3,554	
24	24	-	-	-	48	7.4	7.4	-	-	-	20,700	6.1	34,500	10.1	34,560	10.1	1,483	3,091	3,554	
3 Блок	5	5	5	-	-	15	1.6	1.6	1.6	-	-	10,800	3.2	18,000	5.3	21,600	6.3	690	1,192	1,662
	5	5	7	-	-	17	1.6	1.6	2.5	-	-	12,240	3.6	20,400	6.0	24,480	7.2	782	1,368	1,934
	5	5	9	-	-	19	1.6	1.6	3.2	-	-	13,680	4.0	22,800	6.7	27,360	8.0	876	1,549	2,183
	5	7	7	-	-	19	1.6	2.5	2.5	-	-	13,680	4.0	22,800	6.7	27,360	8.0	876	1,549	2,183
	5	7	9	-	-	21	1.6	2.5	3.2	-	-	15,120	4.4	25,200	7.4	30,240	8.9	972	1,735	2,486
	7	7	7	-	-	21	2.5	2.5	2.5	-	-	15,120	4.4	25,200	7.4	30,240	8.9	972	1,735	2,486
	5	5	12	-	-	22	1.6	1.6	3.9	-	-	15,840	4.6	26,400	7.7	31,680	9.3	1,020	1,817	2,650
	5	9	9	-	-	23	1.6	3.2	3.2	-	-	16,560	4.9	27,600	8.1	33,120	9.7	1,093	1,926	2,831
	7	7	9	-	-	23	2.5	2.5	3.2	-	-	16,560	4.9	27,600	8.1	33,120	9.7	1,093	1,926	2,831
	5	7	12	-	-	24	1.6	2.5	3.9	-	-	17,280	5.1	28,800	8.4	34,560	10.1	1,142	2,010	3,020
	5	5	15	-	-	25	1.6	1.6	4.8	-	-	18,000	5.3	30,000	8.8	36,000	10.6	1,192	2,131	3,266
	7	9	9	-	-	25	2.5	3.2	3.2	-	-	18,000	5.3	30,000	8.8	36,000	10.6	1,192	2,131	3,266
	5	9	12	-	-	26	1.6	3.2	3.9	-	-	18,720	5.5	31,200	9.1	37,440	11.0	1,242	2,228	3,472
	7	7	12	-	-	26	2.5	2.5	3.9	-	-	18,720	5.5	31,200	9.1	37,440	11.0	1,242	2,228	3,472
	5	7	15	-	-	27	1.6	2.5	4.8	-	-	19,440	5.7	32,400	9.5	38,640	11.3	1,292	2,382	3,686
	9	9	9	-	-	27	3.2	3.2	3.2	-	-	19,440	5.7	32,400	9.5	38,640	11.3	1,292	2,382	3,686
	7	9	12	-	-	28	2.5	3.2	3.9	-	-	20,160	5.9	33,600	9.8	38,640	11.3	1,343	2,502	3,686
	5	5	18	-	-	28	1.6	1.6	5.8	-	-	20,160	5.9	33,600	9.8	38,640	11.3	1,343	2,502	3,686
	5	9	15	-	-	29	1.6	3.2	4.8	-	-	20,700	6.1	34,500	10.1	38,640	11.3	1,394	2,626	3,686
	5	12	12	-	-	29	1.6	3.9	3.9	-	-	20,700	6.1	34,500	10.1	38,640	11.3	1,394	2,626	3,686
	7	7	15	-	-	29	2.5	2.5	4.8	-	-	20,700	6.1	34,500	10.1	38,640	11.3	1,394	2,626	3,686
	5	7	18	-	-	30	1.6	2.5	5.8	-	-	20,700	6.1	34,500	10.1	38,640	11.3	1,394	2,626	3,686
	9	9	12	-	-	30	3.2	3.2	3.9	-	-	20,700	6.1	34,500	10.1	38,640	11.3	1,394	2,626	3,686
	7	9	15	-	-	31	2.5	3.2	4.8	-	-	20,700	6.1	34,500	10.1	38,640	11.3	1,394	2,626	3,686
	7	12	12	-	-	31	2.5	3.9	3.9	-	-	20,700	6.1	34,500	10.1	38,640	11.3	1,394	2,626	3,686
	5	12	15	-	-	32	1.6	3.9	4.8	-	-	20,700	6.1	34,500	10.1	38,640	11.3	1,394	2,626	3,686
	5	9	18	-	-	32	1.6	3.2	5.8	-	-	20,700	6.1	34,500	10.1	38,640	11.3	1,394	2,626	3,686
	7	7	18	-	-	32	2.5	2.5	5.8	-	-	20,700	6.1	34,500	10.1	38,640	11.3	1,394	2,626	3,686
	9	9	15	-	-	33	3.2	3.2	4.8	-	-	20,700	6.1	34,500	10.1	38,640	11.3	1,394	2,626	3,686
	9	12	12	-	-	33	3.2	3.9	3.9	-	-	20,700	6.1	34,500	10.1	38,640	11.3	1,394	2,626	3,686
	7	9	18	-	-	34	2.5	3.2	5.8	-	-	20,700	6.1	34,500	10.1	38,640	11.3	1,394	2,626	3,686
	7	12	15	-	-	34	2.5	3.9	4.8	-	-	20,700	6.1	34,500	10.1	38,640	11.3	1,394	2,626	3,686
	5	5	24	-	-	34	1.6	1.6	7.4	-	-	20,700	6.1	34,500	10.1	38,640	11.3	1,394	2,626	3,686
	5	12	18	-	-	35	1.6	3.9	5.8	-	-	20,700	6.1	34,500	10.1	38,640	11.3	1,394	2,626	3,686
	5	15	15	-	-	35	1.6	4.8	4.8	-	-	20,700	6.1	34,500	10.1	38,640	11.3	1,394	2,626	3,686
	5	7	24	-	-	36	1.6	2.5	7.4	-	-	20,700	6.1	34,500	10.1	38,640	11.3	1,394	2,626	3,686
	9	12	15	-	-	36	3.2	3.9	4.8	-	-	20,700	6.1	34,500	10.1	38,640	11.3	1,394	2,626	3,686
	12	12	12	-	-	36	3.9	3.9	3.9	-	-	20,700	6.1	34,500	10.1	38,640	11.3	1,394	2,626	3,686
	9	9	18	-	-	36	3.2	3.2	5.8	-	-	20,700	6.1	34,500	10.1	38,640	11.3	1,394	2,626	3,686
	7	12	18	-	-	37	2.5	3												

# MU5M30

Режим работы	Комбинации внутренних блоков (кВт/ч)						Нагрев													
							Производительность (кВт)					Общая производительность				Потребляемая мощность (Вт)				
							БЛОК А	БЛОК В	БЛОК С	БЛОК D	БЛОК E	Всего	БЛОК А	БЛОК В	БЛОК С	БЛОК D	БЛОК E	Бте/ч	кВт	Бте/ч
3 Блока	7	18	18	-	-	43	2.5	5.8	5.8	-	-	20,700	6.1	34,500	10.1	38,640	11.3	1,394	2,626	3,686
	7	12	24	-	-	43	2.5	3.9	7.4	-	-	20,700	6.1	34,500	10.1	38,640	11.3	1,394	2,626	3,686
	5	15	24	-	-	44	1.6	4.8	7.4	-	-	20,700	6.1	34,500	10.1	38,640	11.3	1,394	2,626	3,686
	9	18	18	-	-	45	3.2	5.8	5.8	-	-	20,700	6.1	34,500	10.1	38,640	11.3	1,394	2,626	3,686
	9	12	24	-	-	45	3.2	3.9	7.4	-	-	20,700	6.1	34,500	10.1	38,640	11.3	1,394	2,626	3,686
	12	15	18	-	-	45	3.9	4.8	5.8	-	-	20,700	6.1	34,500	10.1	38,640	11.3	1,394	2,626	3,686
	15	15	15	-	-	45	4.8	4.8	4.8	-	-	20,700	6.1	34,500	10.1	38,640	11.3	1,394	2,626	3,686
	7	15	24	-	-	46	2.5	4.8	7.4	-	-	20,700	6.1	34,500	10.1	38,640	11.3	1,394	2,626	3,686
	5	18	24	-	-	47	1.6	5.8	7.4	-	-	20,700	6.1	34,500	10.1	38,640	11.3	1,394	2,626	3,686
	9	15	24	-	-	48	3.2	4.8	7.4	-	-	20,700	6.1	34,500	10.1	38,640	11.3	1,394	2,626	3,686
	12	18	18	-	-	48	3.9	5.8	5.8	-	-	20,700	6.1	34,500	10.1	38,640	11.3	1,394	2,626	3,686
	12	12	24	-	-	48	3.9	3.9	7.4	-	-	20,700	6.1	34,500	10.1	38,640	11.3	1,394	2,626	3,686
	15	15	18	-	-	48	4.8	4.8	5.8	-	-	20,700	6.1	34,500	10.1	38,640	11.3	1,394	2,626	3,686
		15	18	-	-	48	3.2	3.2	3.8	-	-	20,700	6.1	34,500	10.1	38,640	11.3	1,584	2,640	3,775
	4 Блока	5	5	5	5	-	20	1.6	1.6	1.6	1.6	-	14,400	4.2	24,000	7.0	28,800	8.4	878	1,547
5		5	5	7	-	22	1.6	1.6	1.6	2.5	-	15,840	4.6	26,400	7.7	31,680	9.3	969	1,726	2,527
5		5	5	9	-	24	1.6	1.6	1.6	3.2	-	17,280	5.1	28,800	8.4	34,560	10.1	1,085	1,909	2,927
5		5	7	7	-	24	1.6	1.6	2.5	2.5	-	17,280	5.1	28,800	8.4	34,560	10.1	1,085	1,909	2,927
5		5	7	9	-	26	1.6	1.6	2.5	3.2	-	18,720	5.5	31,200	9.1	37,440	11.0	1,180	2,116	3,427
5		7	7	7	-	26	1.6	2.5	2.5	2.5	-	18,720	5.5	31,200	9.1	37,440	11.0	1,180	2,116	3,427
5		5	5	12	-	27	1.6	1.6	1.6	3.9	-	19,440	5.7	32,400	9.5	38,640	11.3	1,227	2,281	3,606
5		5	9	9	-	28	1.6	1.6	3.2	3.2	-	20,160	5.9	33,600	9.8	38,640	11.3	1,276	2,411	3,606
5		7	7	9	-	28	1.6	2.5	2.5	3.2	-	20,160	5.9	33,600	9.8	38,640	11.3	1,276	2,411	3,606
7		7	7	7	-	28	2.5	2.5	2.5	2.5	-	20,160	5.9	33,600	9.8	38,640	11.3	1,276	2,411	3,606
5		5	7	12	-	29	1.6	1.6	2.5	3.9	-	20,700	6.1	34,500	10.1	38,640	11.3	1,324	2,545	3,606
5		5	5	15	-	30	1.6	1.6	1.6	4.8	-	20,700	6.1	34,500	10.1	38,640	11.3	1,324	2,545	3,606
5		7	9	9	-	30	1.6	2.5	3.2	3.2	-	20,700	6.1	34,500	10.1	38,640	11.3	1,324	2,545	3,606
7		7	7	9	-	30	2.5	2.5	2.5	3.2	-	20,700	6.1	34,500	10.1	38,640	11.3	1,324	2,545	3,606
5		5	9	12	-	31	1.6	1.6	3.2	3.9	-	20,700	6.1	34,500	10.1	38,640	11.3	1,324	2,545	3,606
5		7	7	12	-	31	1.6	2.5	2.5	3.9	-	20,700	6.1	34,500	10.1	38,640	11.3	1,324	2,545	3,606
5		5	7	15	-	32	1.6	1.6	2.5	4.8	-	20,700	6.1	34,500	10.1	38,640	11.3	1,324	2,545	3,606
7		7	9	9	-	32	2.5	2.5	3.2	3.2	-	20,700	6.1	34,500	10.1	38,640	11.3	1,324	2,545	3,606
5		9	9	9	-	32	1.6	3.2	3.2	3.2	-	20,700	6.1	34,500	10.1	38,640	11.3	1,324	2,545	3,606
5		5	5	18	-	33	1.6	1.6	1.6	5.8	-	20,700	6.1	34,500	10.1	38,640	11.3	1,324	2,545	3,606
5		7	9	12	-	33	1.6	2.5	3.2	3.9	-	20,700	6.1	34,500	10.1	38,640	11.3	1,324	2,545	3,606
7		7	7	12	-	33	2.5	2.5	2.5	3.9	-	20,700	6.1	34,500	10.1	38,640	11.3	1,324	2,545	3,606
5		5	9	15	-	34	1.6	1.6	3.2	4.8	-	20,700	6.1	34,500	10.1	38,640	11.3	1,324	2,545	3,606
5		5	12	12	-	34	1.6	1.6	3.9	3.9	-	20,700	6.1	34,500	10.1	38,640	11.3	1,324	2,545	3,606
5		7	7	15	-	34	1.6	2.5	2.5	4.8	-	20,700	6.1	34,500	10.1	38,640	11.3	1,324	2,545	3,606
7		9	9	9	-	34	2.5	3.2	3.2	3.2	-	20,700	6.1	34,500	10.1	38,640	11.3	1,324	2,545	3,606
5		5	7	18	-	35	1.6	1.6	2.5	5.8	-	20,700	6.1	34,500	10.1	38,640	11.3	1,324	2,545	3,606
5		9	9	12	-	35	1.6	3.2	3.2	3.9	-	20,700	6.1	34,500	10.1	38,640	11.3	1,324	2,545	3,606
7		7	9	12	-	35	2.5	2.5	3.2	3.9	-	20,700	6.1	34,500	10.1	38,640	11.3	1,324	2,545	3,606
5		7	9	15	-	36	1.6	2.5	3.2	4.8	-	20,700	6.1	34,500	10.1	38,640	11.3	1,324	2,545	3,606
5		7	12	12	-	36	1.6	2.5	3.9	3.9	-	20,700	6.1	34,500	10.1	38,640	11.3	1,324	2,545	3,606
7		7	7	15	-	36	2.5	2.5	2.5	4.8	-	20,700	6.1	34,500	10.1	38,640	11.3	1,324	2,545	3,606
9		9	9	9	-	36	3.2	3.2	3.2	3.2	-	20,700	6.1	34,500	10.1	38,640	11.3	1,324	2,545	3,606
5		5	9	18	-	37	1.6	1.6	3.2	5.8	-	20,700	6.1	34,500	10.1	38,640	11.3	1,324	2,545	3,606
5		5	12	15	-	37	1.6	1.6	3.9	4.8	-	20,700	6.1	34,500	10.1	38,640	11.3	1,324	2,545	3,606
5		7	7	18	-	37	1.6	2.5	2.5	5.8	-	20,700	6.1	34,500	10.1	38,640	11.3	1,324	2,545	3,606
7		9	9	12	-	37	2.5	3.2	3.2	3.9	-	20,700	6.1	34,500	10.1	38,640	11.3	1,324	2,545	3,606
5		9	9	15	-	38	1.6	3.2	3.2	4.8	-	20,700	6.1	34,500	10.1	38,640	11.3	1,324	2,545	3,606
7		7	9	15	-	38	2.5	2.5	3.2	4.8	-	20,700	6.1	34,500	10.1	38,640	11.3	1,324	2,545	3,606
7		7	12	12	-	38	2.5	2.5	3.9	3.9	-	20,700	6.1	34,500	10.1	38,640	11.3	1,324	2,545	3,606
5		5	5	24	-	39	1.6	1.6	1.6	7.4	-	20,700	6.1	34,500	10.1	38,640	11.3	1,324	2,545	3,606
5		7	9	18	-	39	1.6	2.5	3.2	5.8	-	20,700	6.1	34,500	10.1	38,640	11.3	1,324	2,545	3,606
5		7	12	15	-	39	1.6	2.5	3.9	4.8	-	20,700	6.1	34,500	10.1	38,640	11.3	1,324	2,545	3,606
9		9	9	12	-	39	3.2	3.2	3.2	3.9	-	20,700	6.1	34,500	10.1	38,640	11.3	1,324	2,545	3,606
7		7	7	18	-	39	2.5	2.5	2.5	5.8	-	20,700	6.1	34,500	10.1	38,640	11.3	1,324	2,545	3,606
7		9	9	15	-	40	2.5	3.2	3.2	4.8	-	20,700	6.1	34,500	10.1	38,640	11.3	1,324	2,545	3,606
7		9	12	12	-	40	2.5	3.2	3.9	3.9	-	20,700	6.1	34,500	10.1	38,640	11.3	1,324	2,545	3,606
5		5	7	24	-	41	1.6	1.6	2.5	7.4	-	20,700	6.1	34,500	10.1	38,640	11.3	1,324	2,545	3,606
5		9	12	15	-	41	1.6	3.2	3.9	4.8	-	20,700	6.1	34,500	10.1	38,640	11.3	1,324	2,545	3,606
5		12	12	12	-	41	1.6	3.9	3.9	3.9	-	20,700	6.1	34,500	10.1	38,640	11.3	1,324	2,545	3,606
7	7	12	15	-	41	2.5	2.5	3.9	4.8	-	20,700	6.1	34,500	10.1	38,640	11.3	1,324	2,545	3,606	
7	7	9	18	-	41	2.5	2.5	3.2	5.8	-	20,700	6.1	34,500	10.1	38,640	11.3	1,324	2,545	3,606	
5	7	15	15	-	42	1.6	2.5	4.8	4.8	-	20,700	6.1	34,500	10.1	38,640	11.3	1,324	2,545	3,606	
9	9	9	15	-	42	3.2	3.2	3.2	4.8	-	20,700	6.1	34,500	10.1	38,640	11.3	1,324	2,545	3,606	
9	9	12	12	-	42	3.2	3.2	3.9	3.9	-	20,700	6.1	34,500	10.1	38,640	11.3	1,324	2,545	3,606	
7	9	12	15	-	43	2.5	3.2	3.9	4.8	-	20,700	6.1	34,500	10.1	38,640	11.3	1,324	2,545	3,606	
7	12	12	12	-	43	2.5														

Режим работы	Комбинации внутренних блоков (кВт/ч)						Нагрев														
							Производительность (кВт)					Общая производительность						Потребляемая мощность (Вт)			
							БЛОК А	БЛОК В	БЛОК С	БЛОК D	БЛОК E	Всего	БТЕ/ч	кВт	БТЕ/ч	кВт	БТЕ/ч	кВт	Минимум	Номинал	Максимум
5 Блоков	5	5	5	5	5	25															
	5	5	5	5	7	27	1.6	1.6	1.6	1.6	1.6	2.5	19,440	5.7	32,400	9.5	38,880	11.4	1,184	2,129	3,300
	5	5	5	5	9	29	1.6	1.6	1.6	1.6	1.6	3.2	20,700	6.1	34,500	10.1	41,400	12.1	1,277	2,290	3,705
	5	5	5	7	7	29	1.6	1.6	1.6	2.5	2.5	2.5	20,700	6.1	34,500	10.1	41,400	12.1	1,277	2,290	3,705
	5	5	5	7	9	31	1.6	1.6	1.6	1.6	2.5	3.2	20,700	6.1	34,500	10.1	41,400	12.1	1,277	2,290	3,705
	5	5	7	7	7	31	1.6	1.6	2.5	2.5	2.5	2.5	20,700	6.1	34,500	10.1	41,400	12.1	1,277	2,290	3,705
	5	5	5	5	12	32	1.6	1.6	1.6	1.6	1.6	3.9	20,700	6.1	34,500	10.1	41,400	12.1	1,277	2,290	3,705
	5	5	5	9	9	33	1.6	1.6	1.6	1.6	3.2	3.2	20,700	6.1	34,500	10.1	41,400	12.1	1,277	2,290	3,705
	5	5	7	7	9	33	1.6	1.6	2.5	2.5	3.2	2.5	20,700	6.1	34,500	10.1	41,400	12.1	1,277	2,290	3,705
	5	7	7	7	7	33	1.6	2.5	2.5	2.5	2.5	2.5	20,700	6.1	34,500	10.1	41,400	12.1	1,277	2,290	3,705
	5	5	5	7	12	34	1.6	1.6	1.6	1.6	2.5	3.9	20,700	6.1	34,500	10.1	41,400	12.1	1,277	2,290	3,705
	5	5	5	5	15	35	1.6	1.6	1.6	1.6	1.6	4.8	20,700	6.1	34,500	10.1	41,400	12.1	1,277	2,290	3,705
	5	7	7	7	9	35	1.6	2.5	2.5	2.5	2.5	3.2	20,700	6.1	34,500	10.1	41,400	12.1	1,277	2,290	3,705
	7	7	7	7	7	35	2.5	2.5	2.5	2.5	2.5	2.5	20,700	6.1	34,500	10.1	41,400	12.1	1,277	2,290	3,705
	5	5	5	9	12	36	1.6	1.6	1.6	1.6	3.2	3.9	20,700	6.1	34,500	10.1	41,400	12.1	1,277	2,290	3,705
	5	5	7	7	12	36	1.6	1.6	2.5	2.5	3.9	2.5	20,700	6.1	34,500	10.1	41,400	12.1	1,277	2,290	3,705
	5	5	5	7	15	37	1.6	1.6	1.6	1.6	2.5	4.8	20,700	6.1	34,500	10.1	41,400	12.1	1,277	2,290	3,705
	5	5	9	9	9	37	1.6	1.6	3.2	3.2	3.2	3.2	20,700	6.1	34,500	10.1	41,400	12.1	1,277	2,290	3,705
	5	7	7	9	9	37	1.6	2.5	2.5	2.5	3.2	3.2	20,700	6.1	34,500	10.1	41,400	12.1	1,277	2,290	3,705
	7	7	7	7	9	37	2.5	2.5	2.5	2.5	3.2	3.2	20,700	6.1	34,500	10.1	41,400	12.1	1,277	2,290	3,705
	5	5	5	5	18	38	1.6	1.6	1.6	1.6	5.8	2.5	20,700	6.1	34,500	10.1	41,400	12.1	1,277	2,290	3,705
	5	7	7	7	12	38	1.6	2.5	2.5	2.5	3.9	2.5	20,700	6.1	34,500	10.1	41,400	12.1	1,277	2,290	3,705
	5	5	5	9	15	39	1.6	1.6	1.6	1.6	3.2	4.8	20,700	6.1	34,500	10.1	41,400	12.1	1,277	2,290	3,705
	5	5	5	12	12	39	1.6	1.6	1.6	3.9	3.9	2.5	20,700	6.1	34,500	10.1	41,400	12.1	1,277	2,290	3,705
	5	5	7	7	15	39	1.6	1.6	2.5	2.5	4.8	2.5	20,700	6.1	34,500	10.1	41,400	12.1	1,277	2,290	3,705
	7	7	7	9	9	39	2.5	2.5	2.5	3.2	3.2	3.2	20,700	6.1	34,500	10.1	41,400	12.1	1,277	2,290	3,705
	5	7	9	9	9	39	1.6	2.5	3.2	3.2	3.2	2.5	20,700	6.1	34,500	10.1	41,400	12.1	1,277	2,290	3,705
	5	5	5	7	18	40	1.6	1.6	1.6	1.6	2.5	5.8	20,700	6.1	34,500	10.1	41,400	12.1	1,277	2,290	3,705
	5	5	9	9	12	40	1.6	1.6	3.2	3.2	3.9	2.5	20,700	6.1	34,500	10.1	41,400	12.1	1,277	2,290	3,705
	5	7	7	9	12	40	1.6	2.5	2.5	3.2	3.9	2.5	20,700	6.1	34,500	10.1	41,400	12.1	1,277	2,290	3,705
	7	7	7	7	12	40	2.5	2.5	2.5	2.5	3.9	2.5	20,700	6.1	34,500	10.1	41,400	12.1	1,277	2,290	3,705
	5	5	7	9	15	41	1.6	1.6	2.5	3.2	4.8	2.5	20,700	6.1	34,500	10.1	41,400	12.1	1,277	2,290	3,705
	5	7	7	7	15	41	1.6	2.5	2.5	2.5	4.8	2.5	20,700	6.1	34,500	10.1	41,400	12.1	1,277	2,290	3,705
	5	9	9	9	9	41	1.6	3.2	3.2	3.2	3.2	2.5	20,700	6.1	34,500	10.1	41,400	12.1	1,277	2,290	3,705
	7	7	9	9	9	41	2.5	2.5	3.2	3.2	3.2	2.5	20,700	6.1	34,500	10.1	41,400	12.1	1,277	2,290	3,705
	5	5	5	9	18	42	1.6	1.6	1.6	3.2	5.8	2.5	20,700	6.1	34,500	10.1	41,400	12.1	1,277	2,290	3,705
	5	5	5	12	15	42	1.6	1.6	1.6	3.9	4.8	2.5	20,700	6.1	34,500	10.1	41,400	12.1	1,277	2,290	3,705
	5	5	7	7	18	42	1.6	1.6	2.5	2.5	5.8	2.5	20,700	6.1	34,500	10.1	41,400	12.1	1,277	2,290	3,705
	5	7	9	9	12	42	1.6	2.5	3.2	3.2	3.9	2.5	20,700	6.1	34,500	10.1	41,400	12.1	1,277	2,290	3,705
	7	7	7	9	12	42	2.5	2.5	2.5	3.2	4.8	2.5	20,700	6.1	34,500	10.1	41,400	12.1	1,277	2,290	3,705
	5	5	9	9	15	43	1.6	1.6	3.2	3.2	4.8	2.5	20,700	6.1	34,500	10.1	41,400	12.1	1,277	2,290	3,705
	5	7	7	9	15	43	1.6	2.5	2.5	3.2	4.8	2.5	20,700	6.1	34,500	10.1	41,400	12.1	1,277	2,290	3,705
	5	7	7	12	12	43	1.6	2.5	2.5	3.9	3.9	2.5	20,700	6.1	34,500	10.1	41,400	12.1	1,277	2,290	3,705
	7	7	7	7	15	43	2.5	2.5	2.5	2.5	4.8	2.5	20,700	6.1	34,500	10.1	41,400	12.1	1,277	2,290	3,705
	7	9	9	9	9	43	2.5	3.2	3.2	3.2	3.2	2.5	20,700	6.1	34,500	10.1	41,400	12.1	1,277	2,290	3,705
	5	5	7	12	15	44	1.6	1.6	2.5	3.9	4.8	2.5	20,700	6.1	34,500	10.1	41,400	12.1	1,277	2,290	3,705
	5	5	5	5	24	44	1.6	1.6	1.6	1.6	7.4	2.5	20,700	6.1	34,500	10.1	41,400	12.1	1,277	2,290	3,705
	5	7	7	7	18	44	1.6	2.5	2.5	2.5	5.8	2.5	20,700	6.1	34,500	10.1	41,400	12.1	1,277	2,290	3,705
	5	9	9	9	12	44	1.6	3.2	3.2	3.2	3.9	2.5	20,700	6.1	34,500	10.1	41,400	12.1	1,277	2,290	3,705
	7	7	9	9	12	44	2.5	2.5	3.2	3.2	3.9	2.5	20,700	6.1	34,500	10.1	41,400	12.1	1,277	2,290	3,705
	5	5	5	12	18	45	1.6	1.6	1.6	3.9	5.8	2.5	20,700	6.1	34,500	10.1	41,400	12.1	1,277	2,290	3,705
	5	5	5	15	15	45	1.6	1.6	1.6	1.6	4.8	4.8	20,700	6.1	34,500	10.1	41,400	12.1	1,277	2,290	3,705
	5	7	9	9	15	45	1.6	2.5	3.2	3.2	4.8	2.5	20,700	6.1	34,500	10.1	41,400	12.1	1,277	2,290	3,705
	5	7	9	12	12	45	1.6	2.5	3.2	3.9	3.9	2.5	20,700	6.1	34,500	10.1	41,400	12.1	1,277	2,290	3,705
	7	7	7	9	15	45	2.5	2.5	2.5	3.2	4.8	2.5	20,700	6.1	34,500	10.1	41,400	12.1	1,277	2,290	3,705
	7	7	7	12	12	45	2.5	2.5	2.5	3.9	3.9	2.5	20,700	6.1	34,500	10.1	41,400	12.1	1,277	2,290	3,705
	9	9	9	9	9	45	3.2	3.2	3.2	3.2	3.2	2.5	20,700	6.1	34,500	10.1	41,400	12.1	1,277	2,290	3,705
	5	5	5	7	24	46	1.6	1.6	1.6	2.5	7.4	2.5	20,700	6.1	34,500	10.1	41,400	12.1	1,277	2,290	3,705
	5	5	9	9	18	46	1.6	1.6	3.2	3.2	5.8	2.5	20,700	6.1	34,500	10.1	41,400	12.1	1,277	2,290	3,705
	5	5	9	12	15	46	1.6	1.6	3.2	3.9	4.8	2.5	20,700	6.1	34,500	10.1	41,400	12.1	1,277	2,290	3,705
	5	5	12	12	12	46	1.6	1.6	3.9	3.9	3.9	2.5	20,700	6.1	34,500	10.1	41,400	12.1	1,277	2,290	3,705
	5	7	7	9	18	46	1.6	2.5	2.5	3.2	5.8	2.5	20,700	6.1	34,500	10.1	41,400	12.1	1,277	2,290	3,705
	5	7	7	12	15	46	1.6	2.5	2.5	3.9	4.8	2.5	20,700	6.1	34,500	10.1	41,400	12.1	1,277	2,290	3,705
	7</																				

# MU5M40

Режим работы	Комбинации внутренних блоков (кВт/ч)						Охлаждение													
							Производительность (кВт)					Общая производительность						Потребляемая мощность (Вт)		
							БЛОК А	БЛОК В	БЛОК С	БЛОК D	БЛОК E	БТЕ/ч	кВт	БТЕ/ч	кВт	БТЕ/ч	кВт	Минимум	Номинал	Максимум
1 Блок	5	-	-	-	-	5	1.5	-	-	-	-	4,500	1.3	5,000	1.5	6,000	1.8	780	1,120	1,703
	7	-	-	-	-	7	2.1	-	-	-	-	4,800	1.4	7,000	2.1	8,400	2.5	780	1,120	1,703
	9	-	-	-	-	9	2.6	-	-	-	-	5,400	1.6	9,000	2.6	10,800	3.2	780	1,120	1,703
	12	-	-	-	-	12	3.5	-	-	-	-	7,200	2.1	12,000	3.5	14,400	4.2	780	1,120	1,703
	15	-	-	-	-	15	4.4	-	-	-	-	8,520	2.5	14,200	4.2	17,040	5.0	780	1,190	1,809
	18	-	-	-	-	18	5.3	-	-	-	-	10,800	3.2	18,000	5.3	21,600	6.3	800	1,260	1,915
	24	-	-	-	-	24	7.0	-	-	-	-	14,400	4.2	24,000	7.0	25,500	7.5	1,042	1,680	2,280
2 Блок	5	5	-	-	-	10	1.5	1.5	-	-	-	6,000	1.8	10,000	2.9	12,000	3.5	780	1,120	1,703
	5	7	-	-	-	12	1.5	2.1	-	-	-	7,200	2.1	12,000	3.5	14,400	4.2	780	1,120	1,703
	5	9	-	-	-	14	1.5	2.6	-	-	-	8,400	2.5	14,000	4.1	16,800	4.9	780	1,120	1,703
	7	7	-	-	-	14	2.1	2.1	-	-	-	8,400	2.5	14,000	4.1	16,800	4.9	780	1,120	1,703
	7	9	-	-	-	16	2.1	2.6	-	-	-	9,600	2.8	16,000	4.7	19,200	5.6	780	1,120	1,703
	5	12	-	-	-	17	1.5	3.5	-	-	-	10,200	3.0	17,000	5.0	20,400	6.0	780	1,190	1,809
	9	9	-	-	-	18	2.6	2.6	-	-	-	10,800	3.2	18,000	5.3	21,600	6.3	800	1,260	1,915
	7	12	-	-	-	19	2.1	3.5	-	-	-	11,400	3.3	19,000	5.6	22,800	6.7	825	1,330	2,022
	5	15	-	-	-	20	1.5	4.4	-	-	-	12,000	3.5	20,000	5.9	24,000	7.0	868	1,400	2,128
	9	12	-	-	-	21	2.6	3.5	-	-	-	12,600	3.7	21,000	6.2	25,200	7.4	911	1,470	2,235
	7	15	-	-	-	22	2.1	4.4	-	-	-	13,200	3.8	22,000	6.4	26,400	7.7	954	1,540	2,341
	5	18	-	-	-	23	1.5	5.3	-	-	-	13,800	4.0	23,000	6.7	27,600	8.1	998	1,610	2,447
	9	15	-	-	-	24	2.6	4.4	-	-	-	14,400	4.2	24,000	7.0	28,800	8.5	1,020	1,645	2,500
	12	12	-	-	-	24	3.5	3.5	-	-	-	14,400	4.2	24,000	7.0	28,800	8.4	1,042	1,680	2,554
	7	18	-	-	-	25	2.1	5.3	-	-	-	15,000	4.4	25,000	7.3	30,000	8.8	1,085	1,750	2,660
	9	18	-	-	-	27	2.6	5.3	-	-	-	16,200	4.7	27,000	7.9	32,400	9.5	1,172	1,890	2,873
	12	15	-	-	-	27	3.5	4.4	-	-	-	16,200	4.7	27,000	7.9	32,400	9.5	1,215	1,960	2,979
	5	24	-	-	-	29	1.5	7.0	-	-	-	17,400	5.1	29,000	8.5	34,800	10.2	1,259	2,030	3,086
	12	18	-	-	-	30	3.5	5.3	-	-	-	18,000	5.3	30,000	8.8	36,000	10.6	1,302	2,100	3,192
	15	15	-	-	-	30	4.4	4.4	-	-	-	18,000	5.3	30,000	8.8	36,000	10.6	1,324	2,135	3,245
	7	24	-	-	-	31	2.1	7.0	-	-	-	18,600	5.5	31,000	9.1	37,200	10.9	1,345	2,170	3,299
	9	24	-	-	-	33	2.6	7.0	-	-	-	19,800	5.8	33,000	9.7	39,600	11.6	1,432	2,310	3,512
	15	18	-	-	-	33	4.4	5.3	-	-	-	19,800	5.8	33,000	9.7	39,600	11.6	1,497	2,415	3,672
	18	18	-	-	-	36	5.3	5.3	-	-	-	21,600	6.3	36,000	10.6	43,200	12.7	1,562	2,520	3,831
12	24	-	-	-	36	3.5	7.0	-	-	-	21,600	6.3	36,000	10.6	43,200	12.7	1,562	2,520	3,831	
15	24	-	-	-	39	3.7	6.0	-	-	-	19,800	5.7	33,000	9.7	39,600	11.6	1,627	2,625	3,991	
18	24	-	-	-	42	5.0	6.7	-	-	-	24,000	7.0	40,000	11.7	46,000	13.5	1,693	2,730	4,150	
24	24	-	-	-	48	5.9	5.9	-	-	-	24,000	7.0	40,000	11.7	46,000	13.5	1,693	2,730	4,150	
3 Блок	5	5	5	-	-	15	1.5	1.5	1.5	-	-	9,000	2.6	15,000	4.4	18,000	5.3	780	1,120	1,703
	5	5	7	-	-	17	1.5	1.5	2.1	-	-	10,200	3.0	17,000	5.0	20,400	6.0	780	1,190	1,809
	5	5	9	-	-	19	1.5	1.5	2.6	-	-	11,400	3.3	19,000	5.6	22,800	6.7	825	1,330	2,022
	5	7	7	-	-	19	1.5	2.1	2.1	-	-	11,400	3.3	19,000	5.6	22,800	6.7	825	1,330	2,022
	5	7	9	-	-	21	1.5	2.1	2.6	-	-	12,600	3.7	21,000	6.2	25,200	7.4	911	1,470	2,235
	7	7	7	-	-	21	2.1	2.1	2.1	-	-	12,600	3.7	21,000	6.2	25,200	7.4	911	1,470	2,235
	5	5	12	-	-	22	1.5	1.5	3.7	-	-	13,800	4.0	23,000	6.7	27,600	8.1	952	1,540	2,341
	7	7	9	-	-	23	2.1	2.1	2.6	-	-	13,800	4.0	23,000	6.7	27,600	8.1	998	1,610	2,447
	5	9	9	-	-	23	1.5	2.6	2.6	-	-	13,800	4.0	23,000	6.7	27,600	8.1	998	1,610	2,447
	5	7	12	-	-	24	1.5	2.1	3.5	-	-	14,400	4.2	24,000	7.0	28,800	8.4	1,042	1,680	2,554
	5	5	15	-	-	25	1.5	1.5	4.4	-	-	15,000	4.4	25,000	7.3	30,000	8.8	1,064	1,715	2,607
	7	9	9	-	-	25	2.1	2.6	2.6	-	-	15,000	4.4	25,000	7.3	30,000	8.8	1,085	1,750	2,660
	5	9	12	-	-	26	1.5	2.6	3.5	-	-	15,600	4.6	26,000	7.6	31,200	9.1	1,128	1,820	2,767
	7	7	12	-	-	26	2.1	2.1	3.5	-	-	15,600	4.6	26,000	7.6	31,200	9.1	1,128	1,820	2,767
	5	7	15	-	-	27	1.5	2.1	4.4	-	-	16,200	4.8	27,000	7.9	32,400	9.5	1,150	1,855	2,820
	9	9	9	-	-	27	2.6	2.6	2.6	-	-	16,200	4.7	27,000	7.9	32,400	9.5	1,172	1,890	2,873
	7	9	12	-	-	28	2.1	2.6	3.5	-	-	16,800	4.9	28,000	8.2	33,600	9.8	1,215	1,960	2,979
	5	5	18	-	-	28	1.5	1.5	5.3	-	-	16,800	4.9	28,000	8.2	33,600	9.8	1,215	1,960	2,979
	5	9	15	-	-	29	1.5	2.6	4.4	-	-	17,400	5.1	29,000	8.5	34,800	10.2	1,237	1,995	3,032
	5	12	12	-	-	29	1.5	3.5	3.5	-	-	17,400	5.1	29,000	8.5	34,800	10.2	1,259	2,030	3,086
	7	7	15	-	-	29	2.1	2.1	4.4	-	-	17,400	5.1	29,000	8.5	34,800	10.2	1,281	2,065	3,139
	5	7	18	-	-	30	1.5	2.1	5.3	-	-	18,000	5.3	30,000	8.8	36,000	10.6	1,302	2,100	3,192
	9	9	12	-	-	30	2.6	2.6	3.5	-	-	18,000	5.3	30,000	8.8	36,000	10.6	1,302	2,100	3,192
	7	9	15	-	-	31	2.0	2.6	4.3	-	-	18,000	5.3	30,000	8.8	36,000	10.6	1,324	2,135	3,245
	7	12	12	-	-	31	2.1	3.5	3.5	-	-	18,600	5.5	31,000	9.1	37,200	10.9	1,345	2,170	3,299
	5	12	15	-	-	32	1.5	3.5	4.4	-	-	19,200	5.6	32,000	9.4	38,400	11.2	1,367	2,205	3,352
	5	9	18	-	-	32	1.5	2.6	5.3	-	-	19,200	5.6	32,000	9.4	38,400	11.3	1,389	2,240	3,405
	7	7	18	-	-	32	2.1	2.1	5.3	-	-	19,200	5.6	32,000	9.4	38,400	11.3	1,389	2,240	3,405
	9	9	15	-	-	33	2.6	2.6	4.4	-	-	19,800	5.8	33,000	9.7	39,600	11.6	1,411	2,275	3,458
	9	12	12	-	-	33	2.6	3.5	3.5	-	-	19,800	5.8	33,000	9.7	39,600	11.6	1,432	2,310	3,512
	7	9	18	-	-	34	2.1	2.6	5.3	-	-	20,400	6.0	34,000	10.0	40,800	12.0	1,476	2,380	3,618
	7	12	15	-	-	34	2.1	3.5	4.4	-	-	20,400	6.0	34,000	10.0	40,800	12.0	1,476	2,380	3,618
	5	5	24	-	-	34	1.5	1.5	7.0	-	-	20,400	6.0	34,000	10.0	40,800	12.0	1,476	2,380	3,618
	5	12	18	-	-	35	1.5	3.5	5.3	-	-	21,000	6.2	35,000	10.3	42,000	12.3	1,519	2,450	3,724
	5	15	15	-	-	35	1.5	4.4	4.4	-	-	21,000	6.2	35,000	10.3	42,000	12.3	1,541	2,485	3,777
	5	7	24	-	-	36	1.5	2.1	7.0	-	-	21,600	6.3	36,000	10.6	43,200	12.7	1,562	2,520	3,831
	9	12	15	-	-	36	2.6	3.5	4.4	-	-	21,600	6.3	36,000	10.6	43,200	12.7	1,562	2,520	3,831
	12	12	12	-	-	36	3.5	3.5	3.5	-	-	21,600	6.3	36,000	10.6	43,200	12.7	1,562	2,520	3,831
	9	9	18	-	-	36	2.6	2.6	5.3	-	-	21,600	6.3	36,000	10.6	43,200	12.7	1,562	2,520	3,831

Режим работы	Комбинации внутренних блоков (кВт/ч)						Охлаждение													
							Производительность (кВт)					Общая производительность						Потребляемая мощность (Вт)		
							БЛОК А	БЛОК В	БЛОК С	БЛОК D	БЛОК E	БТЕ/ч	кВт	БТЕ/ч	кВт	БТЕ/ч	кВт	Минимум	Номинал	Максимум
4 Блока	5	5	5	5	-	20	1.5	1.5	1.5	1.5	-	12,000	3.5	20,000	5.9	24,000	7.0	868	1,400	2,128
	5	5	5	5	-	22	1.5	1.5	1.5	2.1	-	13,200	3.9	22,000	6.4	26,400	7.7	955	1,540	2,341
	5	5	5	9	-	24	1.5	1.5	1.5	2.6	-	14,400	4.2	24,000	7.0	28,800	8.4	1,042	1,680	2,554
	5	5	7	7	-	24	1.5	1.5	2.1	2.1	-	14,400	4.2	24,000	7.0	28,800	8.4	1,042	1,680	2,554
	5	5	7	9	-	26	1.5	1.5	2.1	2.6	-	15,600	4.6	26,000	7.6	31,200	9.1	1,128	1,820	2,767
	5	5	7	7	-	26	1.5	2.1	2.1	2.1	-	15,600	4.6	26,000	7.6	31,200	9.1	1,128	1,820	2,767
	5	5	5	12	-	27	1.5	1.5	1.5	3.5	-	16,200	4.7	27,000	7.9	32,400	9.5	1,172	1,890	2,873
	5	5	9	9	-	28	1.5	1.5	2.6	2.6	-	16,800	4.9	28,000	8.2	33,600	9.8	1,215	1,960	2,979
	5	5	7	9	-	28	1.5	2.1	2.1	2.6	-	16,800	4.9	28,000	8.2	33,600	9.8	1,215	1,960	2,979
	7	7	7	7	-	28	2.1	2.1	2.1	2.1	-	16,800	4.9	28,000	8.2	33,600	9.8	1,215	1,960	2,979
	5	5	7	12	-	29	1.5	1.5	2.1	3.5	-	17,400	5.1	29,000	8.5	34,800	10.2	1,259	2,030	3,086
	5	5	5	15	-	30	1.5	1.5	1.5	4.4	-	18,000	5.3	30,000	8.8	36,000	10.6	1,281	2,065	3,192
	5	7	9	9	-	30	1.5	2.1	2.6	2.6	-	18,000	5.3	30,000	8.8	36,000	10.6	1,302	2,100	3,192
	7	7	7	9	-	30	2.1	2.1	2.1	2.6	-	18,000	5.3	30,000	8.8	36,000	10.6	1,302	2,100	3,192
	5	5	9	12	-	31	1.5	1.5	2.6	3.5	-	18,600	5.5	31,000	9.1	37,200	10.9	1,345	2,170	3,299
	5	7	7	12	-	31	1.5	2.1	2.1	3.5	-	18,600	5.5	31,000	9.1	37,200	10.9	1,345	2,170	3,299
	5	5	7	15	-	32	1.5	1.5	2.1	4.4	-	19,200	5.6	32,000	9.4	38,400	11.2	1,367	2,205	3,352
	7	7	9	9	-	32	2.1	2.1	2.6	2.6	-	19,200	5.6	32,000	9.4	38,400	11.3	1,389	2,240	3,405
	5	9	9	9	-	32	1.5	2.6	2.6	2.6	-	19,200	5.6	32,000	9.4	38,400	11.3	1,389	2,240	3,405
	5	5	5	18	-	33	1.5	1.5	1.5	5.3	-	19,800	5.8	33,000	9.7	39,600	11.6	1,432	2,310	3,512
	5	7	9	12	-	33	1.5	2.1	2.6	3.5	-	19,800	5.8	33,000	9.7	39,600	11.6	1,432	2,310	3,512
	7	7	7	12	-	33	2.1	2.1	2.1	3.5	-	19,800	5.8	33,000	9.7	39,600	11.6	1,432	2,310	3,512
	5	5	9	15	-	34	1.5	1.5	2.6	4.4	-	20,400	6.0	34,000	10.0	40,800	12.0	1,476	2,380	3,618
	5	5	12	12	-	34	1.5	1.5	3.5	3.5	-	20,400	6.0	34,000	10.0	40,800	12.0	1,476	2,380	3,618
	5	7	7	15	-	34	1.5	2.1	2.1	4.4	-	20,400	6.0	34,000	10.0	40,800	12.0	1,476	2,380	3,618
	7	9	9	9	-	34	2.1	2.6	2.6	2.6	-	20,400	6.0	34,000	10.0	40,800	12.0	1,476	2,380	3,618
	5	5	7	18	-	35	1.5	1.5	2.1	5.3	-	21,000	6.2	35,000	10.3	42,000	12.3	1,519	2,450	3,724
	5	9	9	12	-	35	1.5	2.6	2.6	3.5	-	21,000	6.2	35,000	10.3	42,000	12.3	1,519	2,450	3,724
	7	7	9	12	-	35	2.1	2.1	2.6	3.5	-	21,000	6.2	35,000	10.3	42,000	12.3	1,519	2,450	3,724
	5	7	9	15	-	36	1.5	2.1	2.6	4.4	-	21,600	6.4	36,000	10.6	43,200	12.6	1,541	2,485	3,777
	5	7	12	12	-	36	1.5	2.1	3.5	3.5	-	21,600	6.3	36,000	10.6	43,200	12.6	1,562	2,520	3,831
	7	7	7	15	-	36	2.1	2.1	2.1	4.4	-	21,600	6.3	36,000	10.6	43,200	12.6	1,562	2,520	3,831
	9	9	9	9	-	36	2.6	2.6	2.6	2.6	-	21,600	6.3	36,000	10.6	43,200	12.6	1,562	2,520	3,831
	5	5	9	18	-	37	1.5	1.5	2.6	5.3	-	22,200	6.5	37,000	10.8	44,400	13.0	1,606	2,590	3,937
	5	5	12	15	-	37	1.5	1.5	3.5	4.4	-	22,200	6.5	37,000	10.8	44,400	13.0	1,606	2,590	3,937
	5	7	7	18	-	37	1.5	2.1	2.1	5.3	-	22,200	6.5	37,000	10.8	44,400	13.0	1,606	2,590	3,937
	7	9	9	12	-	37	2.1	2.6	2.6	3.5	-	22,200	6.5	37,000	10.8	44,400	13.0	1,606	2,590	3,937
	5	9	9	15	-	38	1.5	2.6	2.6	4.4	-	22,800	6.7	38,000	11.1	45,600	13.4	1,693	2,730	4,150
	7	7	9	15	-	38	2.1	2.1	2.6	4.4	-	22,800	6.7	38,000	11.1	45,600	13.4	1,693	2,730	4,150
	7	7	12	12	-	38	2.1	2.1	3.5	3.5	-	22,800	6.7	38,000	11.1	45,600	13.4	1,693	2,730	4,150
	5	5	5	24	-	39	1.4	1.4	1.4	6.9	-	22,920	6.7	38,200	11.2	46,000	13.5	1,693	2,730	4,150
	5	7	9	18	-	39	1.4	2.0	2.6	5.2	-	22,920	6.7	38,200	11.2	46,000	13.5	1,693	2,730	4,150
	5	7	12	15	-	39	1.4	2.0	3.4	4.3	-	22,920	6.7	38,200	11.2	46,000	13.5	1,693	2,730	4,150
	9	9	9	12	-	39	2.6	2.6	2.6	3.4	-	22,920	6.7	38,200	11.2	46,000	13.5	1,693	2,730	4,150
	7	7	7	18	-	39	2.0	2.0	2.0	5.2	-	22,920	6.7	38,200	11.2	46,000	13.5	1,693	2,730	4,150
	5	5	12	18	-	40	1.4	1.4	3.4	5.0	-	22,920	6.7	38,200	11.2	46,000	13.5	1,693	2,730	4,150
	7	9	9	15	-	40	2.0	2.5	2.5	4.2	-	22,920	6.7	38,200	11.2	46,000	13.5	1,693	2,730	4,150
	7	9	12	12	-	40	2.0	2.5	3.4	3.4	-	22,920	6.7	38,200	11.2	46,000	13.5	1,693	2,730	4,150
5	5	7	24	-	41	1.4	1.4	1.9	6.6	-	22,920	6.7	38,200	11.2	46,000	13.5	1,693	2,730	4,150	
5	9	12	15	-	41	1.4	2.5	3.3	4.1	-	22,920	6.7	38,200	11.2	46,000	13.5	1,693	2,730	4,150	
5	12	12	12	-	41	1.4	3.3	3.3	3.3	-	22,920	6.7	38,200	11.2	46,000	13.5	1,693	2,730	4,150	
7	7	9	18	-	41	1.9	1.9	2.5	4.9	-	22,920	6.7	38,200	11.2	46,000	13.5	1,693	2,730	4,150	
7	7	12	15	-	41	1.9	1.9	3.3	4.1	-	22,920	6.7	38,200	11.2	46,000	13.5	1,693	2,730	4,150	
5	7	15	15	-	42	1.3	1.9	4.0	4.0	-	22,920	6.7	38,200	11.2	46,000	13.5	1,693	2,730	4,150	
9	9	9	15	-	42	2.4	2.4	2.4	4.0	-	22,920	6.7	38,200	11.2	46,000	13.5	1,693	2,730	4,150	
9	9	12	12	-	42	2.4	2.4	3.2	3.2	-	22,920	6.7	38,200	11.2	46,000	13.5	1,693	2,730	4,150	
7	9	12	15	-	43	1.8	2.3	3.1	3.9	-	22,920	6.7	38,200	11.2	46,000	13.5	1,693	2,730	4,150	
7	12	12	12	-	43	1.8	3.1	3.1	3.1	-	22,920	6.7	38,200	11.2	46,000	13.5	1,693	2,730	4,150	
7	9	9	18	-	43	1.8	2.3	2.3	4.7	-	22,920	6.7	38,200	11.2	46,000	13.5	1,693	2,730	4,150	
5	9	15	15	-	44	1.3	2.3	3.8	3.8	-	22,920	6.7	38,200	11.2	46,000	13.5	1,693	2,730	4,150	
7	7	12	18	-	44	1.8	1.8	3.1	4.6	-	22,920	6.7	38,200	11.2	46,000	13.5	1,693	2,730	4,150	
7	7	15	15	-	44	1.8	1.8	3.8	3.8	-	22,920	6.7	38,200	11.2	46,000	13.5	1,693	2,730	4,150	
5	7	18	15	-	45	1.2	1.7	4.5	3.7	-	22,920	6.7	38,200	11.2	46,000	13.5	1,693	2,730	4,150	
9	9	12	15	-	45	2.2	2.2	3.0	3.7	-	22,920	6.7	38,200	11.2	46,000	13.5	1,693	2,730	4,150	
9	12	12	12	-	45	2.2	3.0	3.0	3.0	-	22,920	6.7	38,200	11.2	46,000	13.5	1,693	2,730	4,150	
9	9	9	18	-	45	2.2	2.2	2.2	4.5	-	22,920	6.7	38,200	11.2	46,000	13.5	1,693	2,730	4,150	
7	7	7	24	-	45	1.7	1.7	1.7	6.0	-	22,920	6.7	38,200	11.2	46,000	13.5	1,693	2,730	4,150	
7	9	12	18	-	46	1.7	2.2	2.9	4.4	-	22,920	6.7	38,200	11.2	46,000	13.5	1,693	2,730	4,150	
7	9	15	15	-	46	1.7	2.2	3.7	3.7	-	22,920	6.7	38,200	11.2	46,000	13.5	1,693	2,730	4,150	
7	12	12	15	-	46	1.7	2.9	2.9	3.7	-	22,920	6.7	38,200	11.2	46,000	13.5	1,693	2,730	4,150	
5	5	18	18	-	46	1.2	1.2	4.4	4.4	-	22,920	6.7	38,200	11.2	46,000	13.5	1,693</			



# MU5M40

Режим работы	Комбинации внутренних блоков (кВт/ч)						Охлаждение													
							Производительность (кВт)					Общая производительность				Потребляемая мощность (Вт)				
							БЛОК А	БЛОК В	БЛОК С	БЛОК D	БЛОК E	Всего	БТЕ/Ч	кВт	БТЕ/Ч	кВт	БТЕ/Ч	кВт	Минимум	Номинал
5 Блоков	5	7	7	7	7	33	1.5	2.1	2.1	2.1	2.1	19,800	5.8	33,000	9.7	39,600	11.6	1,432	2,310	3,512
	5	5	5	7	12	34	1.5	1.5	1.5	2.1	3.5	20,400	6.0	34,000	10.0	40,800	12.0	1,476	2,380	3,618
	5	5	5	5	15	35	1.5	1.5	1.5	1.5	4.4	21,000	6.2	35,000	10.3	42,000	12.3	1,498	2,415	3,671
	5	7	7	7	9	35	1.5	2.1	2.1	2.1	2.6	21,000	6.2	35,000	10.3	42,000	12.3	1,519	2,450	3,724
	7	7	7	7	7	35	2.1	2.1	2.1	2.1	2.1	21,000	6.2	35,000	10.3	42,000	12.3	1,519	2,450	3,724
	5	5	5	9	12	36	1.5	1.5	1.5	2.6	3.5	21,600	6.3	36,000	10.6	43,200	12.7	1,562	2,520	3,831
	5	5	7	7	12	36	1.5	1.5	2.1	2.1	3.5	21,600	6.3	36,000	10.6	43,200	12.7	1,562	2,520	3,831
	5	5	5	7	15	37	1.5	1.5	1.5	2.1	4.4	22,200	6.4	37,000	10.8	44,400	13.0	1,584	2,555	3,884
	5	5	9	9	9	37	1.5	1.5	2.6	2.6	2.6	22,200	6.5	37,000	10.8	44,400	13.0	1,606	2,590	3,937
	5	7	7	9	9	37	1.5	2.1	2.1	2.6	2.6	22,200	6.5	37,000	10.8	44,400	13.0	1,606	2,590	3,937
	7	7	7	7	9	37	2.1	2.1	2.1	2.1	2.6	22,200	6.5	37,000	10.8	44,400	13.0	1,606	2,590	3,937
	5	5	5	5	18	38	1.5	1.5	1.5	1.5	5.3	22,800	6.7	38,000	11.1	45,600	13.4	1,649	2,660	4,044
	5	7	7	7	12	38	1.5	2.1	2.1	2.1	3.5	22,800	6.7	38,000	11.1	45,600	13.4	1,649	2,660	4,044
	5	5	5	9	15	39	1.4	1.4	1.4	2.6	4.3	22,920	6.8	38,200	11.2	45,840	13.5	1,671	2,695	4,097
	5	5	5	12	12	39	1.4	1.4	1.4	3.4	3.4	22,920	6.7	38,200	11.2	46,000	13.5	1,693	2,730	4,150
	5	5	7	7	15	39	1.4	1.4	2.0	2.0	4.3	22,920	6.7	38,200	11.2	46,000	13.5	1,693	2,730	4,150
	7	7	7	9	9	39	2.0	2.0	2.0	2.6	2.6	22,920	6.7	38,200	11.2	46,000	13.5	1,693	2,730	4,150
	5	7	9	9	9	39	1.4	2.0	2.6	2.6	2.6	22,920	6.7	38,200	11.2	46,000	13.5	1,693	2,730	4,150
	5	5	5	7	18	40	1.4	1.4	1.4	2.0	5.0	22,920	6.7	38,200	11.2	46,000	13.5	1,693	2,730	4,150
	5	5	9	9	12	40	1.4	1.4	2.5	2.5	3.4	22,920	6.7	38,200	11.2	46,000	13.5	1,693	2,730	4,150
	5	7	7	9	12	40	1.4	2.0	2.0	2.5	3.4	22,920	6.7	38,200	11.2	46,000	13.5	1,693	2,730	4,150
	7	7	7	7	12	40	2.0	2.0	2.0	2.0	3.4	22,920	6.7	38,200	11.2	46,000	13.5	1,693	2,730	4,150
	5	5	7	9	15	41	1.4	1.4	1.9	2.5	4.1	22,920	6.7	38,200	11.2	46,000	13.5	1,693	2,730	4,150
	5	7	7	7	15	41	1.4	1.9	1.9	1.9	4.1	22,920	6.7	38,200	11.2	46,000	13.5	1,693	2,730	4,150
	5	9	9	9	9	41	1.4	2.5	2.5	2.5	2.5	22,920	6.7	38,200	11.2	46,000	13.5	1,693	2,730	4,150
	7	7	9	9	9	41	1.9	1.9	2.5	2.5	2.5	22,920	6.7	38,200	11.2	46,000	13.5	1,693	2,730	4,150
	5	5	5	9	18	42	1.3	1.3	1.3	2.4	4.8	22,920	6.7	38,200	11.2	46,000	13.5	1,693	2,730	4,150
	5	5	5	12	15	42	1.3	1.3	1.3	3.2	4.0	22,920	6.7	38,200	11.2	46,000	13.5	1,693	2,730	4,150
	5	5	7	7	18	42	1.3	1.3	1.9	1.9	4.8	22,920	6.7	38,200	11.2	46,000	13.5	1,693	2,730	4,150
	5	7	9	9	12	42	1.3	1.9	2.4	2.4	3.2	22,920	6.7	38,200	11.2	46,000	13.5	1,693	2,730	4,150
	7	7	7	9	12	42	1.9	1.9	1.9	2.4	3.2	22,920	6.7	38,200	11.2	46,000	13.5	1,693	2,730	4,150
	5	5	9	9	15	43	1.3	1.3	2.3	2.3	3.9	22,920	6.7	38,200	11.2	46,000	13.5	1,693	2,730	4,150
	5	7	7	9	15	43	1.3	1.8	1.8	2.3	3.9	22,920	6.7	38,200	11.2	46,000	13.5	1,693	2,730	4,150
	5	7	7	12	12	43	1.3	1.8	1.8	3.1	3.1	22,920	6.7	38,200	11.2	46,000	13.5	1,693	2,730	4,150
	7	7	7	7	15	43	1.8	1.8	1.8	1.8	3.9	22,920	6.7	38,200	11.2	46,000	13.5	1,693	2,730	4,150
	7	9	9	9	9	43	1.8	2.3	2.3	2.3	2.3	22,920	6.7	38,200	11.2	46,000	13.5	1,693	2,730	4,150
	5	5	7	12	15	44	1.3	1.3	1.8	3.1	3.8	22,920	6.7	38,200	11.2	46,000	13.5	1,693	2,730	4,150
	5	5	5	5	24	44	1.3	1.3	1.3	1.3	6.1	22,920	6.7	38,200	11.2	46,000	13.5	1,693	2,730	4,150
	5	7	7	7	18	44	1.3	1.8	1.8	1.8	4.6	22,920	6.7	38,200	11.2	46,000	13.5	1,693	2,730	4,150
	5	9	9	9	12	44	1.3	2.3	2.3	2.3	3.1	22,920	6.7	38,200	11.2	46,000	13.5	1,693	2,730	4,150
	7	7	9	9	12	44	1.8	1.8	2.3	2.3	3.1	22,920	6.7	38,200	11.2	46,000	13.5	1,693	2,730	4,150
	5	5	5	12	18	45	1.2	1.2	1.2	3.0	4.5	22,920	6.7	38,200	11.2	46,000	13.5	1,693	2,730	4,150
	5	5	5	15	15	45	1.2	1.2	1.2	3.7	3.7	22,920	6.7	38,200	11.2	46,000	13.5	1,693	2,730	4,150
	5	7	9	9	15	45	1.2	1.7	2.2	2.2	3.7	22,920	6.7	38,200	11.2	46,000	13.5	1,693	2,730	4,150
	5	7	9	12	12	45	1.2	1.7	2.2	3.0	3.0	22,920	6.7	38,200	11.2	46,000	13.5	1,693	2,730	4,150
	7	7	7	9	15	45	1.7	1.7	1.7	2.2	3.7	22,920	6.7	38,200	11.2	46,000	13.5	1,693	2,730	4,150
	7	7	7	12	12	45	1.7	1.7	1.7	3.0	3.0	22,920	6.7	38,200	11.2	46,000	13.5	1,693	2,730	4,150
	9	9	9	9	9	45	2.2	2.2	2.2	2.2	2.2	22,920	6.7	38,200	11.2	46,000	13.5	1,693	2,730	4,150
	5	5	5	7	24	46	1.2	1.2	1.2	1.7	5.8	22,920	6.7	38,200	11.2	46,000	13.5	1,693	2,730	4,150
	5	5	9	9	18	46	1.2	1.2	2.2	2.2	4.4	22,920	6.7	38,200	11.2	46,000	13.5	1,693	2,730	4,150
	5	5	9	12	15	46	1.2	1.2	2.2	2.9	3.7	22,920	6.7	38,200	11.2	46,000	13.5	1,693	2,730	4,150
	5	5	12	12	12	46	1.2	1.2	2.9	2.9	2.9	22,920	6.7	38,200	11.2	46,000	13.5	1,693	2,730	4,150
5	7	7	9	18	46	1.2	1.7	2.2	4.4	22,920	6.7	38,200	11.2	46,000	13.5	1,693	2,730	4,150		
5	7	7	12	15	46	1.2	1.7	1.7	2.9	3.7	22,920	6.7	38,200	11.2	46,000	13.5	1,693	2,730	4,150	
7	7	7	7	18	46	1.7	1.7	1.7	1.7	4.4	22,920	6.7	38,200	11.2	46,000	13.5	1,693	2,730	4,150	
7	9	9	9	12	46	1.7	2.2	2.2	2.2	2.9	22,920	6.7	38,200	11.2	46,000	13.5	1,693	2,730	4,150	
5	5	7	15	15	47	1.2	1.2	1.7	3.6	3.6	22,920	6.7	38,200	11.2	46,000	13.5	1,693	2,730	4,150	
5	9	9	9	15	47	1.2	2.1	2.1	2.1	3.6	22,920	6.7	38,200	11.2	46,000	13.5	1,693	2,730	4,150	
5	9	9	12	12	47	1.2	2.1	2.1	2.9	2.9	22,920	6.7	38,200	11.2	46,000	13.5	1,693	2,730	4,150	
7	7	9	9	15	47	1.7	1.7	2.1	2.1	3.6	22,920	6.7	38,200	11.2	46,000	13.5	1,693	2,730	4,150	
7	7	9	12	12	47	1.7	1.7	2.1	2.9	2.9	22,920	6.7	38,200	11.2	46,000	13.5	1,693	2,730	4,150	
5	5	5	9	24	48	1.2	1.2	1.2	2.1	5.6	22,920	6.7	38,200	11.2	46,000	13.5	1,693	2,730	4,150	
5	5	5	15	18	48	1.2	1.2	1.2	3.5	4.2	22,920	6.7	38,200	11.2	46,000	13.5	1,693	2,730	4,150	
5	5	7	7	24	48	1.2	1.2	1.6	1.6	5.6	22,920	6.7	38,200	11.2	46,000	13.5	1,693	2,730	4,150	
5	7	9	9	18	48	1.2	1.6	2.1	2.1	4.2	22,920	6.7	38,200	11.2	46,000	13.5	1,693	2,730	4,150	
5	7	9	12	15	48	1.2	1.6	2.1	2.8	3.5	22,920	6.7	38,200	11.2	46,000	13.5	1,693	2,730	4,150	
5	7	12	12	12	48	1.2	1.6	2.8	2.8	2.8	22,920	6.7	38,200	11.2	46,000	13.5	1,693	2,730	4,150	
7	7	7	12	15	48	1.6	1.6	1.6	2.8	3.5	22,920	6.7	38,200	11.2	46,000	13.5	1,693	2,730	4,150	
9	9	9	9	12	48	2.1	2.1	2.1	2.1	2.8	22,920	6.7	38,200	11.2	46,000					

Режим работы	Комбинации внутренних блоков (кВт/ч)						Нагрев													
							Производительность (кВт)					Общая производительность						Потребляемая мощность (Вт)		
							Блок А	Блок В	Блок С	Блок D	Блок E	Всего	Блок А	Блок В	Блок С	Блок D	Блок E	Бте/ч	кВт	Бте/ч
1 Блок	5	-	-	-	-	5	1.6	-	-	-	-	5,000	1.5	5,500	1.6	6,600	1.9	820	1,120	1,826
	7	-	-	-	-	7	2.5	-	-	-	-	5,500	1.6	8,400	2.5	9,660	2.8	820	1,120	1,826
	9	-	-	-	-	9	3.2	-	-	-	-	6,480	1.9	10,800	3.2	12,420	3.6	820	1,120	1,826
	12	-	-	-	-	12	3.9	-	-	-	-	7,920	2.3	13,200	3.9	15,840	4.6	820	1,120	1,826
	15	-	-	-	-	15	4.8	-	-	-	-	9,900	2.9	16,500	4.8	18,975	5.6	820	1,190	1,826
	18	-	-	-	-	18	5.8	-	-	-	-	11,880	3.5	19,800	5.8	22,770	6.7	820	1,260	1,966
	24	-	-	-	-	24	7.4	-	-	-	-	15,240	4.5	25,400	7.4	26,670	7.8	1,042	1,680	2,296
	5	5	-	-	-	10	1.6	1.6	-	-	-	6,600	1.9	11,000	3.2	13,200	3.9	820	1,120	1,826
2 Блок	5	7	-	-	-	12	1.6	2.3	-	-	-	7,920	2.3	13,200	3.9	15,840	4.6	820	1,120	1,826
	5	9	-	-	-	14	1.6	2.9	-	-	-	9,240	2.7	15,400	4.5	18,480	5.4	820	1,120	1,826
	7	7	-	-	-	14	2.3	2.3	-	-	-	9,240	2.7	15,400	4.5	18,480	5.4	820	1,120	1,826
	7	9	-	-	-	16	2.3	2.9	-	-	-	10,560	3.1	17,600	5.2	21,120	6.2	820	1,120	1,826
	5	12	-	-	-	17	1.6	3.9	-	-	-	11,220	3.3	18,700	5.5	22,440	6.6	820	1,190	1,940
	9	9	-	-	-	18	2.9	2.9	-	-	-	11,880	3.5	19,800	5.8	23,760	7.0	820	1,260	2,054
	7	12	-	-	-	19	2.3	3.9	-	-	-	12,540	3.7	20,900	6.1	25,080	7.4	825	1,330	2,168
	5	15	-	-	-	20	1.6	4.8	-	-	-	13,200	3.9	22,000	6.4	26,400	7.8	868	1,400	2,282
	9	12	-	-	-	21	2.9	3.9	-	-	-	13,860	4.1	23,100	6.8	27,720	8.1	911	1,470	2,396
	7	15	-	-	-	22	2.3	4.8	-	-	-	14,520	4.3	24,200	7.1	29,040	8.4	954	1,540	2,510
	5	18	-	-	-	23	1.6	5.8	-	-	-	15,180	4.4	25,300	7.4	30,360	8.9	998	1,610	2,624
	9	15	-	-	-	24	2.9	4.8	-	-	-	15,840	4.6	26,400	7.7	31,680	9.3	1,020	1,645	2,681
	12	12	-	-	-	24	3.9	3.9	-	-	-	15,840	4.6	26,400	7.7	31,680	9.3	1,042	1,680	2,738
	7	18	-	-	-	25	2.3	5.8	-	-	-	16,500	4.8	27,500	8.1	33,000	9.7	1,085	1,750	2,853
	9	18	-	-	-	27	2.9	5.8	-	-	-	17,820	5.2	29,700	8.7	35,640	10.4	1,172	1,890	3,081
	12	15	-	-	-	27	3.9	4.8	-	-	-	17,820	5.2	29,700	8.7	35,640	10.4	1,215	1,960	3,195
	5	24	-	-	-	29	1.6	7.7	-	-	-	19,140	5.6	31,900	9.3	38,280	11.2	1,259	2,030	3,309
	12	18	-	-	-	30	3.9	5.8	-	-	-	19,800	5.8	33,000	9.7	39,600	11.6	1,302	2,100	3,423
	15	15	-	-	-	30	4.8	4.8	-	-	-	19,800	5.8	33,000	9.7	39,600	11.6	1,324	2,135	3,480
	7	24	-	-	-	31	2.3	7.7	-	-	-	20,460	6.0	34,100	10.0	40,920	12.0	1,345	2,170	3,537
	9	24	-	-	-	33	2.9	7.7	-	-	-	21,780	6.4	36,300	10.6	43,560	12.8	1,432	2,310	3,765
	15	18	-	-	-	33	4.8	5.8	-	-	-	21,780	6.4	36,300	10.6	43,560	12.8	1,497	2,415	3,936
	18	18	-	-	-	36	5.8	5.8	-	-	-	23,760	7.0	39,600	11.6	47,520	13.9	1,562	2,520	4,108
	12	24	-	-	-	36	3.9	7.7	-	-	-	23,760	7.0	39,600	11.6	47,520	13.9	1,562	2,520	4,108
	15	24	-	-	-	39	4.8	7.7	-	-	-	25,620	7.5	42,700	12.5	51,200	15.0	1,742	2,810	4,450
	18	24	-	-	-	42	5.4	7.2	-	-	-	25,620	7.5	42,700	12.5	51,200	15.0	1,742	2,810	4,450
	24	24	-	-	-	48	6.3	6.3	-	-	-	25,620	7.5	42,700	12.5	51,200	15.0	1,742	2,810	4,450
	5	5	5	-	-	15	1.6	1.6	1.6	-	-	9,900	2.9	16,500	4.8	19,800	5.8	820	1,120	1,826
5	5	7	-	-	17	1.6	1.6	2.3	-	-	11,220	3.3	18,700	5.5	22,440	6.6	820	1,190	1,940	
5	5	9	-	-	19	1.6	1.6	2.9	-	-	12,540	3.7	20,900	6.1	25,080	7.4	825	1,330	2,168	
5	7	7	-	-	19	1.6	2.3	2.3	-	-	12,540	3.7	20,900	6.1	25,080	7.4	825	1,330	2,168	
5	7	9	-	-	21	1.6	2.3	2.9	-	-	13,860	4.1	23,100	6.8	27,720	8.1	911	1,470	2,396	
7	7	7	-	-	21	2.3	2.3	2.3	-	-	13,860	4.1	23,100	6.8	27,720	8.1	911	1,470	2,396	
5	5	12	-	-	22	1.6	1.6	3.9	-	-	14,520	4.3	24,200	7.1	29,040	8.5	955	1,540	2,510	
7	7	9	-	-	23	2.3	2.3	2.9	-	-	15,180	4.4	25,300	7.4	30,360	8.9	998	1,610	2,624	
5	9	9	-	-	23	1.6	2.9	2.9	-	-	15,180	4.4	25,300	7.4	30,360	8.9	998	1,610	2,624	
5	7	12	-	-	24	1.6	2.3	3.9	-	-	15,840	4.6	26,400	7.7	31,680	9.3	1,042	1,680	2,738	
5	5	15	-	-	25	1.6	1.6	4.8	-	-	16,500	4.8	27,500	8.1	33,000	9.7	1,064	1,715	2,795	
7	9	9	-	-	25	2.3	2.9	2.9	-	-	16,500	4.8	27,500	8.1	33,000	9.7	1,085	1,750	2,853	
5	9	12	-	-	26	1.6	2.9	3.9	-	-	17,160	5.0	28,600	8.4	34,320	10.1	1,128	1,820	2,967	
7	7	12	-	-	26	2.3	2.3	3.9	-	-	17,160	5.0	28,600	8.4	34,320	10.1	1,128	1,820	2,967	
5	7	15	-	-	27	1.6	2.3	4.8	-	-	17,820	5.2	29,700	8.7	35,640	10.5	1,150	1,855	3,024	
9	9	9	-	-	27	2.9	2.9	2.9	-	-	17,820	5.2	29,700	8.7	35,640	10.4	1,172	1,890	3,081	
7	9	12	-	-	28	2.3	2.9	3.9	-	-	18,480	5.4	30,800	9.0	36,960	10.8	1,215	1,960	3,195	
5	5	18	-	-	28	1.6	1.6	5.8	-	-	18,480	5.4	30,800	9.0	36,960	10.8	1,215	1,960	3,195	
5	9	15	-	-	29	1.6	2.9	4.8	-	-	19,140	5.6	31,900	9.3	38,280	11.2	1,237	1,995	3,252	
5	12	12	-	-	29	1.6	3.9	3.9	-	-	19,140	5.6	31,900	9.3	38,280	11.2	1,259	2,030	3,309	
7	7	15	-	-	29	2.3	2.3	4.8	-	-	19,140	5.6	31,900	9.3	38,280	11.2	1,259	2,030	3,309	
5	7	18	-	-	30	1.6	2.3	5.8	-	-	19,800	5.8	33,000	9.7	39,600	11.6	1,302	2,100	3,423	
9	9	12	-	-	30	2.9	2.9	3.9	-	-	19,800	5.8	33,000	9.7	39,600	11.6	1,302	2,100	3,423	
7	9	15	-	-	31	2.3	2.9	4.8	-	-	20,460	6.0	34,100	10.0	40,920	12.0	1,345	2,170	3,537	
7	12	12	-	-	31	2.3	3.9	3.9	-	-	20,460	6.0	34,100	10.0	40,920	12.0	1,345	2,170	3,537	
5	12	15	-	-	32	1.6	3.9	4.8	-	-	21,120	6.2	35,200	10.3	42,240	12.4	1,389	2,240	3,651	
5	9	18	-	-	32	1.6	2.9	5.8	-	-	21,120	6.2	35,200	10.3	42,240	12.4	1,389	2,240	3,651	
7	7	18	-	-	32	2.3	2.3	5.8	-	-	21,120	6.2	35,200	10.3	42,240	12.4	1,389	2,240	3,651	
9	9	15	-	-	33	2.9	2.9	4.8	-	-	21,780	6.4	36,300	10.6	43,560	12.8	1,433	2,310	3,765	
9	12	12	-	-	33	2.9	3.9	3.9	-	-	21,780	6.4	36,300	10.6	43,560	12.8	1,433	2,310	3,765	
7	9	18	-	-	34	2.3	2.9	5.8	-	-	22,440	6.6	37,400	11.0	44,880	13.2	1,476	2,380	3,879	
7	12	15	-	-	34	2.3	3.9	4.8	-	-	22,440	6.6	37,400	11.0	44,880	13.2	1,476	2,380	3,879	
5	5	24	-	-	34	1.6	1.6	7.7	-	-	22,440	6.6	37,400	11.0	44,880	13.2	1,476	2,380	3,879	
5	12	18	-	-	35	1.6	3.9	5.8	-	-	23,100	6.8	38,500	11.3	46,200	13.5	1,519	2,450	3,994	
5	15	15	-	-	35	1.6	4.8	4.8	-	-	23,100	6.8	38,500	11.3	46,200	13.5	1,519	2,450	3,994	
5	7	24	-	-	36	1.6	2.3	7.7	-	-	23,760	7.0	39,600	11.6	47,520	13.9	1,562	2,520	4,108	
9	12	15	-	-	36	2.9	3.9	4.8	-	-	23,760	7.0	39,600	11.6	47,520	13.9	1,562	2,520	4,108	
12	12	12	-	-	36	3.9	3.9	3.9	-	-	23,760	7.0	39,600	11.6	47,520	13.9	1,562	2,520	4,108	
9	9	18	-	-	36	2.9	2.9	5.8	-	-	23,760	7.0	39,600	11.6	47,520	13.9	1,562	2,520	4,108	

# MU5M40

Режим работы	Комбинации внутренних блоков (кВт/ч)						Нагрев													
							Производительность (кВт)					Общая производительность						Потребляемая мощность (Вт)		
							Блок А	Блок В	Блок С	Блок D	Блок E	Всего	Блок А	Блок В	Блок С	Блок D	Блок E	Бте/ч	кВт	Бте/ч
4 Блока	5	5	5	5	-	20	1.7	1.7	1.7	1.7	-	13,860	4.1	23,100	6.8	27,720	8.1	868	1,400	2,282
	5	5	5	7	-	22	1.7	1.7	1.7	2.4	-	15,180	4.4	25,300	7.4	30,360	8.9	955	1,540	2,510
	5	5	5	9	-	24	1.6	1.6	1.6	2.9	-	15,840	4.6	26,400	7.7	31,680	9.3	1,042	1,680	2,738
	5	5	7	7	-	24	1.6	1.6	2.3	2.3	-	15,840	4.6	26,400	7.7	31,680	9.3	1,042	1,680	2,738
	5	5	7	9	-	26	1.6	1.6	2.3	2.9	-	17,160	5.0	28,600	8.4	34,320	10.1	1,128	1,820	2,967
	5	7	7	7	-	26	1.6	2.3	2.3	2.3	-	17,160	5.0	28,600	8.4	34,320	10.1	1,128	1,820	2,967
	5	5	5	12	-	27	1.6	1.6	1.6	3.9	-	17,820	5.2	29,700	8.7	35,640	10.4	1,172	1,890	3,081
	5	5	9	9	-	28	1.6	1.6	2.9	2.9	-	18,480	5.4	30,800	9.0	36,960	10.8	1,215	1,960	3,195
	5	7	7	9	-	28	1.6	2.3	2.3	2.9	-	18,480	5.4	30,800	9.0	36,960	10.8	1,215	1,960	3,195
	7	7	7	7	-	28	2.3	2.3	2.3	2.3	-	18,480	5.4	30,800	9.0	36,960	10.8	1,215	1,960	3,195
	5	5	7	12	-	29	1.6	1.6	2.3	3.9	-	19,140	5.6	31,900	9.3	38,280	11.2	1,259	2,030	3,309
	5	5	5	15	-	30	1.6	1.6	1.6	4.8	-	19,800	5.8	33,000	9.7	39,600	11.6	1,281	2,065	3,366
	5	7	9	9	-	30	1.6	2.3	2.9	2.9	-	19,800	5.8	33,000	9.7	39,600	11.6	1,302	2,100	3,423
	7	7	7	9	-	30	2.3	2.3	2.3	2.9	-	19,800	5.8	33,000	9.7	39,600	11.6	1,302	2,100	3,423
	5	5	9	12	-	31	1.6	1.6	2.9	3.9	-	20,460	6.0	34,100	10.0	40,920	12.0	1,345	2,170	3,537
	5	7	7	12	-	31	1.6	2.3	2.3	3.9	-	20,460	6.0	34,100	10.0	40,920	12.0	1,345	2,170	3,537
	5	5	7	15	-	32	1.6	1.6	2.3	4.8	-	21,120	6.2	35,200	10.3	42,240	12.4	1,367	2,205	3,594
	7	7	9	9	-	32	2.3	2.3	2.9	2.9	-	21,120	6.2	35,200	10.3	42,240	12.4	1,389	2,240	3,651
	5	9	9	9	-	32	1.6	2.9	2.9	2.9	-	21,120	6.2	35,200	10.3	42,240	12.4	1,389	2,240	3,651
	5	5	5	18	-	33	1.6	1.6	1.6	5.8	-	21,780	6.4	36,300	10.6	43,560	12.8	1,432	2,310	3,765
	5	7	9	12	-	33	1.6	2.3	2.9	3.9	-	21,780	6.4	36,300	10.6	43,560	12.8	1,432	2,310	3,765
	7	7	7	12	-	33	2.3	2.3	2.3	3.9	-	21,780	6.4	36,300	10.6	43,560	12.8	1,432	2,310	3,765
	5	5	9	15	-	34	1.6	1.6	2.9	4.8	-	22,440	6.6	37,400	11.0	44,880	13.2	1,454	2,345	3,822
	5	5	12	12	-	34	1.6	1.6	3.9	3.9	-	22,440	6.6	37,400	11.0	44,880	13.2	1,476	2,380	3,879
	5	7	7	15	-	34	1.6	2.3	2.3	4.8	-	22,440	6.6	37,400	11.0	44,880	13.2	1,476	2,380	3,879
	7	9	9	9	-	34	2.3	2.9	2.9	2.9	-	22,440	6.6	37,400	11.0	44,880	13.2	1,476	2,380	3,879
	5	5	7	18	-	35	1.6	1.6	2.3	5.8	-	23,100	6.8	38,500	11.3	46,200	13.5	1,519	2,450	3,994
	5	9	9	12	-	35	1.6	2.9	2.9	3.9	-	23,100	6.8	38,500	11.3	46,200	13.5	1,519	2,450	3,994
	7	7	9	12	-	35	2.3	2.3	2.9	3.9	-	23,100	6.8	38,500	11.3	46,200	13.5	1,519	2,450	3,994
	5	7	9	15	-	36	1.6	2.3	2.9	4.8	-	23,760	7.0	39,600	11.6	47,520	13.9	1,541	2,485	4,051
	5	7	12	12	-	36	1.6	2.3	3.9	3.9	-	23,760	7.0	39,600	11.6	47,520	13.9	1,562	2,520	4,108
	7	7	7	15	-	36	2.3	2.3	2.3	4.8	-	23,760	7.0	39,600	11.6	47,520	13.9	1,562	2,520	4,108
	9	9	9	9	-	36	2.9	2.9	2.9	2.9	-	23,760	7.0	39,600	11.6	47,520	13.9	1,562	2,520	4,108
	5	5	9	18	-	37	1.6	1.6	2.9	5.8	-	24,420	7.2	40,700	11.9	48,840	14.3	1,606	2,590	4,222
	5	5	12	15	-	37	1.6	1.6	3.9	4.8	-	24,420	7.2	40,700	11.9	48,840	14.3	1,606	2,590	4,222
	5	7	7	18	-	37	1.6	2.3	2.3	5.8	-	24,420	7.2	40,700	11.9	48,840	14.3	1,606	2,590	4,222
	7	9	9	12	-	37	2.3	2.9	2.9	3.9	-	24,420	7.2	40,700	11.9	48,840	14.3	1,606	2,590	4,222
	5	9	9	15	-	38	1.6	2.9	2.9	4.8	-	25,080	7.4	41,800	12.3	50,160	14.7	1,649	2,660	4,336
	7	7	9	15	-	38	2.3	2.3	2.9	4.8	-	25,080	7.4	41,800	12.3	50,160	14.7	1,649	2,660	4,336
	7	7	12	12	-	38	2.3	2.3	3.9	3.9	-	25,080	7.4	41,800	12.3	50,160	14.7	1,649	2,660	4,336
	5	5	5	24	-	39	1.6	1.6	1.6	7.7	-	25,620	7.5	42,700	12.5	51,200	15.0	1,742	2,810	4,450
	5	7	9	18	-	39	1.6	2.2	2.9	5.8	-	25,620	7.5	42,700	12.5	51,200	15.0	1,742	2,810	4,450
	5	7	12	15	-	39	1.6	2.2	3.9	4.8	-	25,620	7.5	42,700	12.5	51,200	15.0	1,742	2,810	4,450
	9	9	9	12	-	39	2.9	2.9	2.9	3.9	-	25,620	7.5	42,700	12.5	51,200	15.0	1,742	2,810	4,450
	7	7	7	18	-	39	2.2	2.2	2.2	5.8	-	25,620	7.5	42,700	12.5	51,200	15.0	1,742	2,810	4,450
	5	5	12	18	-	40	1.6	1.6	3.8	5.6	-	25,620	7.5	42,700	12.5	51,200	15.0	1,742	2,810	4,450
	7	9	9	15	-	40	2.2	2.8	2.8	4.7	-	25,620	7.5	42,700	12.5	51,200	15.0	1,742	2,810	4,450
	7	9	12	12	-	40	2.2	2.8	3.8	3.8	-	25,620	7.5	42,700	12.5	51,200	15.0	1,742	2,810	4,450
5	5	7	24	-	41	1.5	1.5	2.1	7.3	-	25,620	7.5	42,700	12.5	51,200	15.0	1,742	2,810	4,450	
5	9	12	15	-	41	1.5	2.7	3.7	4.6	-	25,620	7.5	42,700	12.5	51,200	15.0	1,742	2,810	4,450	
5	12	12	18	-	41	1.5	3.7	3.7	3.7	-	25,620	7.5	42,700	12.5	51,200	15.0	1,742	2,810	4,450	
7	7	9	18	-	41	2.1	2.1	2.7	5.5	-	25,620	7.5	42,700	12.5	51,200	15.0	1,742	2,810	4,450	
7	7	12	15	-	41	2.1	2.1	3.7	4.6	-	25,620	7.5	42,700	12.5	51,200	15.0	1,742	2,810	4,450	
5	7	15	15	-	42	1.5	2.1	4.5	4.5	-	25,620	7.5	42,700	12.5	51,200	15.0	1,742	2,810	4,450	
9	9	9	15	-	42	2.7	2.7	2.7	4.5	-	25,620	7.5	42,700	12.5	51,200	15.0	1,742	2,810	4,450	
9	9	12	12	-	42	2.7	2.7	3.6	3.6	-	25,620	7.5	42,700	12.5	51,200	15.0	1,742	2,810	4,450	
7	9	12	15	-	43	2.0	2.6	3.5	4.4	-	25,620	7.5	42,700	12.5	51,200	15.0	1,742	2,810	4,450	
7	12	12	12	-	43	2.0	3.5	3.5	3.5	-	25,620	7.5	42,700	12.5	51,200	15.0	1,742	2,810	4,450	
7	9	9	18	-	43	2.0	2.6	2.6	5.2	-	25,620	7.5	42,700	12.5	51,200	15.0	1,742	2,810	4,450	
5	9	15	15	-	44	1.4	2.6	4.3	4.3	-	25,620	7.5	42,700	12.5	51,200	15.0	1,742	2,810	4,450	
7	7	12	18	-	44	2.0	2.0	3.4	5.1	-	25,620	7.5	42,700	12.5	51,200	15.0	1,742	2,810	4,450	
7	7	15	15	-	44	2.0	2.0	4.3	4.3	-	25,620	7.5	42,700	12.5	51,200	15.0	1,742	2,810	4,450	
5	7	18	15	-	45	1.4	1.9	5.0	4.2	-	25,620	7.5	42,700	12.5	51,200	15.0	1,742	2,810	4,450	
9	9	12	15	-	45	2.5	2.5	3.3	4.2	-	25,620	7.5	42,700	12.5	51,200	15.0	1,742	2,810	4,450	
9	12	12	12	-	45	2.5	3.3	3.3	3.3	-	25,620	7.5	42,700	12.5	51,200	15.0	1,742	2,810	4,450	
9	9	9	18	-	45	2.5	2.5	2.5	5.0	-	25,620	7.5	42,700	12.5	51,200	15.0	1,742	2,810	4,450	
7	7	7	24	-	45	1.9	1.9	1.9	6.7	-	25,620	7.5	42,700	12.5	51,200	15.0	1,742	2,810	4,450	
7	9	12	18	-	46	1.9	2.4	3.3	4.9	-	25,620	7.5	42,700	12.5	51,200	15.0	1,742	2,810	4,450	
7	9	15	15	-	46	1.9	2.4	4.1	4.1	-	25,620	7.5	42,700	12.5	51,200	15.0	1,742	2,810	4,450	
7	12	12	15	-	46	1.9	3.3	3.3	4.1	-	25,620	7.5	42,700	12.5	51,200	15.0	1,742	2,810	4,450	
5	5	18	18	-	46	1.4	1.4	4.9	4.9	-	25,620	7.5	42,700	12.5	51,200	15.0	1,742	2,810	4,450	
5	12	12	18	-	47	1.3	3.2	3.2	4.8											

Режим работы	Комбинации внутренних блоков (кВт/ч)						Нагрев														
							Производительность (кВт)					Общая производительность						Потребляемая мощность (Вт)			
							Блок А	Блок В	Блок С	Блок D	Блок E	Всего	Минимум		Номинал		Максимум		Минимум	Номинал	Максимум
Блок А	Блок В	Блок С	Блок D	Блок E	Бте/ч	кВт							Бте/ч	кВт	Бте/ч	кВт					
5 Блоков	5	5	5	7	12	34	1.6	1.6	1.6	2.3	3.9	22,440	6.6	37,400	11.0	44,880	13.2	1,476	2,380	3,879	
	5	5	5	5	15	35	1.6	1.6	1.6	1.6	4.8	23,100	6.8	38,500	11.3	46,200	13.5	1,498	2,415	3,936	
	5	7	7	7	9	35	1.6	2.3	2.3	2.3	2.9	23,100	6.8	38,500	11.3	46,200	13.5	1,519	2,450	3,994	
	7	7	7	7	7	35	2.3	2.3	2.3	2.3	2.3	23,100	6.8	38,500	11.3	46,200	13.5	1,519	2,450	3,994	
	5	5	5	9	12	36	1.6	1.6	1.6	2.9	3.9	23,760	7.0	39,600	11.6	47,520	13.9	1,562	2,520	4,108	
	5	5	7	7	12	36	1.6	1.6	2.3	2.3	3.9	23,760	7.0	39,600	11.6	47,520	13.9	1,562	2,520	4,108	
	5	5	5	7	15	37	1.6	1.6	1.6	2.3	4.8	24,420	7.2	40,700	11.9	48,840	14.3	1,584	2,555	4,165	
	5	5	9	9	9	37	1.6	1.6	2.9	2.9	2.9	24,420	7.2	40,700	11.9	48,840	14.3	1,606	2,590	4,222	
	5	7	7	9	9	37	1.6	2.3	2.3	2.3	2.9	24,420	7.2	40,700	11.9	48,840	14.3	1,606	2,590	4,222	
	5	7	7	7	9	37	2.3	2.3	2.3	2.3	2.9	24,420	7.2	40,700	11.9	48,840	14.3	1,606	2,590	4,222	
	5	5	5	5	18	38	1.6	1.6	1.6	1.6	5.8	25,080	7.4	41,800	12.3	50,160	14.7	1,649	2,660	4,336	
	5	7	7	7	12	38	1.6	2.3	2.3	2.3	3.9	25,080	7.4	41,800	12.3	50,160	14.7	1,649	2,660	4,336	
	5	5	5	9	15	39	1.6	1.6	1.6	2.9	4.8	25,620	7.5	42,700	12.5	51,240	15.0	1,695	2,735	4,458	
	5	5	5	12	12	39	1.6	1.6	1.6	3.9	3.9	25,620	7.5	42,700	12.5	51,200	15.0	1,742	2,810	4,450	
	5	5	7	7	15	39	1.6	1.6	2.2	2.2	4.8	25,620	7.5	42,700	12.5	51,200	15.0	1,742	2,810	4,450	
	7	7	7	9	9	39	2.2	2.2	2.2	2.2	2.9	25,620	7.5	42,700	12.5	51,200	15.0	1,742	2,810	4,450	
	5	7	9	9	9	39	1.6	2.2	2.9	2.9	2.9	25,620	7.5	42,700	12.5	51,200	15.0	1,742	2,810	4,450	
	5	5	5	7	18	40	1.6	1.6	1.6	2.2	5.6	25,620	7.5	42,700	12.5	51,200	15.0	1,742	2,810	4,450	
	5	5	9	9	12	40	1.6	1.6	2.8	2.8	3.8	25,620	7.5	42,700	12.5	51,200	15.0	1,742	2,810	4,450	
	5	7	7	9	12	40	1.6	2.2	2.2	2.2	3.8	25,620	7.5	42,700	12.5	51,200	15.0	1,742	2,810	4,450	
	7	7	7	7	12	40	2.2	2.2	2.2	2.2	3.8	25,620	7.5	42,700	12.5	51,200	15.0	1,742	2,810	4,450	
	5	5	7	9	15	41	1.5	1.5	2.1	2.1	2.7	4.6	25,620	7.5	42,700	12.5	51,200	15.0	1,742	2,810	4,450
	5	7	7	7	15	41	1.5	2.1	2.1	2.1	4.6	25,620	7.5	42,700	12.5	51,200	15.0	1,742	2,810	4,450	
	5	9	9	9	9	41	1.5	2.7	2.7	2.7	2.7	25,620	7.5	42,700	12.5	51,200	15.0	1,742	2,810	4,450	
	7	7	9	9	9	41	2.1	2.1	2.7	2.7	2.7	25,620	7.5	42,700	12.5	51,200	15.0	1,742	2,810	4,450	
	5	5	5	9	18	42	1.5	1.5	1.5	2.7	5.4	25,620	7.5	42,700	12.5	51,200	15.0	1,742	2,810	4,450	
	5	5	5	12	15	42	1.5	1.5	1.5	3.6	4.5	25,620	7.5	42,700	12.5	51,200	15.0	1,742	2,810	4,450	
	5	5	7	7	18	42	1.5	1.5	2.1	2.1	5.4	25,620	7.5	42,700	12.5	51,200	15.0	1,742	2,810	4,450	
	5	7	9	9	12	42	1.5	2.1	2.7	2.7	3.6	25,620	7.5	42,700	12.5	51,200	15.0	1,742	2,810	4,450	
	7	7	7	9	12	42	2.1	2.1	2.1	2.1	3.6	25,620	7.5	42,700	12.5	51,200	15.0	1,742	2,810	4,450	
	5	5	9	9	15	43	1.5	1.5	2.6	2.6	4.4	25,620	7.5	42,700	12.5	51,200	15.0	1,742	2,810	4,450	
	5	7	7	9	15	43	1.5	2.0	2.0	2.6	4.4	25,620	7.5	42,700	12.5	51,200	15.0	1,742	2,810	4,450	
	5	7	7	12	12	43	1.5	2.0	2.0	3.5	3.5	25,620	7.5	42,700	12.5	51,200	15.0	1,742	2,810	4,450	
	7	7	7	7	15	43	2.0	2.0	2.0	2.0	4.4	25,620	7.5	42,700	12.5	51,200	15.0	1,742	2,810	4,450	
	7	9	9	9	9	43	2.0	2.6	2.6	2.6	2.6	25,620	7.5	42,700	12.5	51,200	15.0	1,742	2,810	4,450	
	5	5	7	12	15	44	1.4	1.4	2.0	3.4	4.3	25,620	7.5	42,700	12.5	51,200	15.0	1,742	2,810	4,450	
	5	5	5	5	24	44	1.4	1.4	1.4	1.4	6.8	25,620	7.5	42,700	12.5	51,200	15.0	1,742	2,810	4,450	
	5	7	7	7	18	44	1.4	2.0	2.0	2.0	5.1	25,620	7.5	42,700	12.5	51,200	15.0	1,742	2,810	4,450	
	5	9	9	9	12	44	1.4	2.6	2.6	2.6	3.4	25,620	7.5	42,700	12.5	51,200	15.0	1,742	2,810	4,450	
	7	7	9	9	12	44	2.0	2.6	2.6	2.6	3.4	25,620	7.5	42,700	12.5	51,200	15.0	1,742	2,810	4,450	
	5	5	5	12	18	45	1.4	1.4	1.4	3.3	5.0	25,620	7.5	42,700	12.5	51,200	15.0	1,742	2,810	4,450	
	5	5	5	15	15	45	1.4	1.4	1.4	4.2	4.2	25,620	7.5	42,700	12.5	51,200	15.0	1,742	2,810	4,450	
	5	7	9	9	15	45	1.4	1.9	2.5	2.5	4.2	25,620	7.5	42,700	12.5	51,200	15.0	1,742	2,810	4,450	
	5	7	9	12	12	45	1.4	1.9	2.5	3.3	3.3	25,620	7.5	42,700	12.5	51,200	15.0	1,742	2,810	4,450	
	7	7	7	9	15	45	1.9	1.9	1.9	2.5	4.2	25,620	7.5	42,700	12.5	51,200	15.0	1,742	2,810	4,450	
	7	7	7	12	12	45	1.9	1.9	1.9	3.3	3.3	25,620	7.5	42,700	12.5	51,200	15.0	1,742	2,810	4,450	
	9	9	9	9	9	45	2.5	2.5	2.5	2.5	2.5	25,620	7.5	42,700	12.5	51,200	15.0	1,742	2,810	4,450	
	5	5	5	7	24	46	1.4	1.4	1.4	1.9	6.5	25,620	7.5	42,700	12.5	51,200	15.0	1,742	2,810	4,450	
	5	5	9	9	18	46	1.4	1.4	2.4	2.4	4.9	25,620	7.5	42,700	12.5	51,200	15.0	1,742	2,810	4,450	
	5	5	9	12	15	46	1.4	1.4	2.4	3.3	4.1	25,620	7.5	42,700	12.5	51,200	15.0	1,742	2,810	4,450	
	5	5	12	12	12	46	1.4	1.4	3.3	3.3	3.3	25,620	7.5	42,700	12.5	51,200	15.0	1,742	2,810	4,450	
	5	7	7	9	18	46	1.4	1.9	1.9	2.4	4.9	25,620	7.5	42,700	12.5	51,200	15.0	1,742	2,810	4,450	
5	7	7	12	15	46	1.4	1.9	1.9	3.3	4.1	25,620	7.5	42,700	12.5	51,200	15.0	1,742	2,810	4,450		
7	7	7	7	18	46	1.9	1.9	1.9	1.9	4.9	25,620	7.5	42,700	12.5	51,200	15.0	1,742	2,810	4,450		
7	9	9	9	12	46	1.9	2.4	2.4	2.4	3.3	25,620	7.5	42,700	12.5	51,200	15.0	1,742	2,810	4,450		
5	5	7	15	15	47	1.3	1.3	1.9	4.0	4.0	25,620	7.5	42,700	12.5	51,200	15.0	1,742	2,810	4,450		
5	9	9	9	15	47	1.3	2.4	2.4	2.4	4.0	25,620	7.5	42,700	12.5	51,200	15.0	1,742	2,810	4,450		
5	9	9	12	12	47	1.3	2.4	2.4	3.2	3.2	25,620	7.5	42,700	12.5	51,200	15.0	1,742	2,810	4,450		
7	7	9	9	15	47	1.9	1.9	2.4	2.4	4.0	25,620	7.5	42,700	12.5	51,200	15.0	1,742	2,810	4,450		
7	7	9	12	12	47	1.9	1.9	2.4	3.2	3.2	25,620	7.5	42,700	12.5	51,200	15.0	1,742	2,810	4,450		
5	5	5	9	24	48	1.3	1.3	1.3	2.3	6.3	25,620	7.5	42,700	12.5	51,200	15.0	1,742	2,810	4,450		
5	5	5	18	15	48	1.3	1.3	1.3	4.7	3.9	25,620	7.5	42,700	12.5	51,200	15.0	1,742	2,810	4,450		
5	5	7	7	24	48	1.3	1.3	1.8	1.8	6.3	25,620	7.5	42,700	12.5	51,200	15.0	1,742	2,810	4,450		
5	7	9	9	18	48	1.3	1.8	2.3	2.3	4.7	25,620	7.5	42,700	12.5	51,200	15.0	1,742	2,810	4,450		
5	7	9	12	15	48	1.3	1.8	2.3	3.1	3.9	25,620	7.5	42,700	12.5	51,200	15.0	1,742	2,810	4,450		
5	7	12	12	12	48	1.3	1.8	3.1	3.1	3.1	25,620	7.5	42,700	12.5	51,200	15.0	1,742	2,810	4,450		
7	7	7	12	15	48	1.8	1.8	1.8	3.1	3.9	25,620	7.5	42,700	12.5	51,200	15.0	1,742	2,810	4,450		
9	9																				

# FM40AH

Суммарный индекс производительности внутренних блоков (тыс. БТЕ/ч)	Охлаждение /общая производительность/						Потребляемая мощность (Вт)			Нагрев /общая производительность/						Потребляемая мощность (Вт)		
	Минимум		Номинал		Максимум					Минимум		Номинал		Максимум				
	БТЕ/ч	кВт	БТЕ/ч	кВт	БТЕ/ч	кВт	Минимум	Номинал	Максимум	БТЕ/ч	кВт	БТЕ/ч	кВт	БТЕ/ч	кВт	Минимум	Номинал	Максимум
16	9,600	2.8	16,000	4.7	19,200	5.6	780	1,120	1,703	10,560	3.1	17,600	5.2	21,120	6.2	820	1,120	1,826
18	10,800	3.2	18,000	5.3	21,600	6.3	800	1,260	1,915	11,880	3.5	19,800	5.8	23,760	7.0	820	1,260	2,054
19	11,400	3.3	19,000	5.6	22,800	6.7	825	1,330	2,022	12,540	3.7	20,900	6.1	25,080	7.4	825	1,330	2,168
21	12,600	3.7	21,000	6.2	25,200	7.4	911	1,470	2,235	13,860	4.1	23,100	6.8	27,720	8.1	911	1,470	2,396
23	13,800	4.0	23,000	6.7	27,600	8.1	998	1,610	2,447	15,180	4.4	25,300	7.4	30,360	8.9	998	1,610	2,624
24	14,400	4.2	24,000	7.0	28,800	8.4	1,042	1,680	2,554	15,840	4.6	26,400	7.7	31,680	9.3	1,042	1,680	2,738
25	15,000	4.4	25,000	7.3	30,000	8.8	1,085	1,750	2,660	16,500	4.8	27,500	8.1	33,000	9.7	1,085	1,750	2,853
26	15,600	4.6	26,000	7.6	31,200	9.1	1,128	1,820	2,767	17,160	5.0	28,600	8.4	34,320	10.1	1,128	1,820	2,967
27	16,200	4.7	27,000	7.9	32,400	9.5	1,172	1,890	2,873	17,820	5.2	29,700	8.7	35,640	10.4	1,172	1,890	3,081
28	16,800	4.9	28,000	8.2	33,600	9.8	1,215	1,960	2,979	18,480	5.4	30,800	9.0	36,960	10.8	1,215	1,960	3,195
29	17,400	5.1	29,000	8.5	34,800	10.2	1,259	2,030	3,086	19,140	5.6	31,900	9.3	38,280	11.2	1,259	2,030	3,309
30	18,000	5.3	30,000	8.8	36,000	10.6	1,302	2,100	3,192	19,800	5.8	33,000	9.7	39,600	11.6	1,302	2,100	3,423
31	18,600	5.5	31,000	9.1	37,200	10.9	1,345	2,170	3,299	20,460	6.0	34,100	10.0	40,920	12.0	1,345	2,170	3,537
32	19,200	5.6	32,000	9.4	38,400	11.3	1,389	2,240	3,405	21,120	6.2	35,200	10.3	42,240	12.4	1,389	2,240	3,651
33	19,800	5.8	33,000	9.7	39,600	11.6	1,432	2,310	3,512	21,780	6.4	36,300	10.6	43,560	12.8	1,432	2,310	3,765
34	20,400	6.0	34,000	10.0	40,800	12.0	1,476	2,380	3,618	22,440	6.6	37,400	11.0	44,880	13.2	1,476	2,380	3,879
35	21,000	6.2	35,000	10.3	42,000	12.3	1,519	2,450	3,724	23,100	6.8	38,500	11.3	46,200	13.5	1,519	2,450	3,994
36	21,600	6.3	36,000	10.6	43,200	12.7	1,562	2,520	3,831	23,760	7.0	39,600	11.6	47,520	13.9	1,562	2,520	4,108
37	22,200	6.5	37,000	10.8	44,400	13.0	1,606	2,590	3,937	24,420	7.2	40,700	11.9	48,840	14.3	1,606	2,590	4,222
38	22,800	6.7	38,000	11.1	45,600	13.4	1,649	2,660	4,044	25,080	7.4	41,800	12.3	50,160	14.7	1,649	2,660	4,336
39	22,920	6.7	38,200	11.2	46,000	13.5	1,693	2,730	4,150	25,620	7.5	42,700	12.5	51,200	15.0	1,742	2,810	4,450
40	22,920	6.7	38,200	11.2	46,000	13.5	1,693	2,730	4,150	25,620	7.5	42,700	12.5	51,200	15.0	1,742	2,810	4,450
41	22,920	6.7	38,200	11.2	46,000	13.5	1,693	2,730	4,150	25,620	7.5	42,700	12.5	51,200	15.0	1,742	2,810	4,450
42	22,920	6.7	38,200	11.2	46,000	13.5	1,693	2,730	4,150	25,620	7.5	42,700	12.5	51,200	15.0	1,742	2,810	4,450
43	22,920	6.7	38,200	11.2	46,000	13.5	1,693	2,730	4,150	25,620	7.5	42,700	12.5	51,200	15.0	1,742	2,810	4,450
44	22,920	6.7	38,200	11.2	46,000	13.5	1,693	2,730	4,150	25,620	7.5	42,700	12.5	51,200	15.0	1,742	2,810	4,450
45	22,920	6.7	38,200	11.2	46,000	13.5	1,693	2,730	4,150	25,620	7.5	42,700	12.5	51,200	15.0	1,742	2,810	4,450
46	22,920	6.7	38,200	11.2	46,000	13.5	1,693	2,730	4,150	25,620	7.5	42,700	12.5	51,200	15.0	1,742	2,810	4,450
47	22,920	6.7	38,200	11.2	46,000	13.5	1,693	2,730	4,150	25,620	7.5	42,700	12.5	51,200	15.0	1,742	2,810	4,450
48	22,920	6.7	38,200	11.2	46,000	13.5	1,693	2,730	4,150	25,620	7.5	42,700	12.5	51,200	15.0	1,742	2,810	4,450
49	22,920	6.7	38,200	11.2	46,000	13.5	1,693	2,730	4,150	25,620	7.5	42,700	12.5	51,200	15.0	1,742	2,810	4,450
50	22,920	6.7	38,200	11.2	46,000	13.5	1,693	2,730	4,150	25,620	7.5	42,700	12.5	51,200	15.0	1,742	2,810	4,450
51	22,920	6.7	38,200	11.2	46,000	13.5	1,693	2,730	4,150	25,620	7.5	42,700	12.5	51,200	15.0	1,742	2,810	4,450
52	22,920	6.7	38,200	11.2	46,000	13.5	1,693	2,730	4,150	25,620	7.5	42,700	12.5	51,200	15.0	1,742	2,810	4,450
53	22,920	6.7	38,200	11.2	46,000	13.5	1,693	2,730	4,150	25,620	7.5	42,700	12.5	51,200	15.0	1,742	2,810	4,450
54	22,920	6.7	38,200	11.2	46,000	13.5	1,693	2,730	4,150	25,620	7.5	42,700	12.5	51,200	15.0	1,742	2,810	4,450

Примечание:

- Производительность охлаждения указана для следующих условий: температура в помещении 27 °Сст / 19 °Сст, температура наружного воздуха 35 °Сст
- Производительность нагрева указана для следующих условий: температура в помещении 20 °Сст; температура наружного воздуха 7 °Сст / 6 °Сст
- Номинальные производительности являются суммарными производительности внутренних блоков при постоянной частоте вращения инверторного компрессора. Эти значения производительности получены расчетным путем и должны использоваться в качестве справочной информации.
- Общая производительность внутренних блоков должна быть в диапазоне от 16 до 52 кВт/ч (40%–130%)
- К наружному блоку должны быть подключены минимум два внутренних блока.

# FM48AH

Суммарный индекс производительности внутренних блоков (тыс БТЕ/ч)	Охлаждение /общая производительность/						Потребляемая мощность (Вт)			Нагрев /общая производительность/						Потребляемая мощность (Вт)								
	Минимум		Номинал		Максимум		Минимум			Минимум		Номинал		Максимум		Минимум			Номинал			Максимум		
	БТЕ/ч	кВт	БТЕ/ч	кВт	БТЕ/ч	кВт	Минимум	Номинал	Максимум	БТЕ/ч	кВт	БТЕ/ч	кВт	БТЕ/ч	кВт	Минимум	Номинал	Максимум	Минимум	Номинал	Максимум	Минимум	Номинал	Максимум
19	11,400	3.3	18,535	5.4	20,900	6.1	840	1,222	1,665	12,768	3.7	23,088	6.8	27,365	8.0	1,300	1,728	2,470						
20	12,000	3.5	19,510	5.7	22,000	6.4	880	1,282	1,746	13,440	3.9	24,303	7.1	28,482	8.3	1,348	1,863	2,663						
21	12,600	3.7	20,486	6.0	23,100	6.8	920	1,341	1,827	14,112	4.1	25,518	7.5	29,600	8.7	1,395	1,997	2,855						
22	13,200	3.9	21,461	6.3	24,200	7.1	960	1,401	1,908	14,784	4.3	26,733	7.8	30,869	9.0	1,443	2,132	3,048						
23	13,800	4.0	22,437	6.6	25,300	7.4	1,000	1,460	1,989	15,456	4.5	27,948	8.2	32,138	9.4	1,490	2,267	3,240						
24	14,400	4.2	23,412	6.9	25,705	7.5	1,085	1,520	2,071	16,023	4.7	28,973	8.5	33,407	9.8	1,579	2,402	3,433						
25	15,000	4.4	24,388	7.1	26,776	7.8	1,128	1,579	2,152	16,590	4.9	29,998	8.8	34,676	10.2	1,626	2,473	3,535						
26	15,600	4.6	25,363	7.4	27,847	8.2	1,170	1,639	2,233	17,157	5.0	31,024	9.1	35,945	10.5	1,672	2,544	3,637						
27	16,200	4.7	26,339	7.7	28,918	8.5	1,213	1,698	2,314	17,724	5.2	32,049	9.4	37,214	10.9	1,719	2,616	3,739						
28	16,800	4.9	27,314	8.0	29,989	8.8	1,256	1,758	2,395	18,290	5.4	33,074	9.7	38,483	11.3	1,766	2,687	3,842						
29	17,400	5.1	28,290	8.3	31,060	9.1	1,298	1,817	2,476	18,857	5.5	34,099	10.0	39,752	11.7	1,813	2,759	3,944						
30	18,000	5.3	29,265	8.6	32,131	9.4	1,355	1,897	2,584	19,424	5.7	35,124	10.3	41,021	12.0	1,860	2,830	4,046						
31	18,600	5.5	30,241	8.9	33,202	9.7	1,412	1,976	2,693	19,991	5.9	36,149	10.6	42,290	12.4	1,907	2,902	4,148						
32	19,200	5.6	31,216	9.1	34,273	10.0	1,468	2,056	2,801	20,558	6.0	37,174	10.9	43,560	12.8	1,954	2,973	4,250						
33	19,800	5.8	32,192	9.4	35,344	10.4	1,525	2,135	2,909	21,125	6.2	38,199	11.2	44,648	13.1	1,973	3,001	4,290						
34	20,400	6.0	33,167	9.7	36,415	10.7	1,582	2,215	3,018	21,692	6.4	39,224	11.5	45,736	13.4	1,991	3,029	4,330						
35	21,000	6.2	34,143	10.0	37,486	11.0	1,639	2,294	3,126	22,259	6.5	40,249	11.8	46,824	13.7	2,009	3,057	4,370						
36	21,600	6.3	35,118	10.3	38,557	11.3	1,696	2,374	3,235	22,825	6.7	41,274	12.1	47,912	14.0	2,028	3,085	4,409						
37	22,200	6.5	36,094	10.6	39,628	11.6	1,752	2,453	3,343	23,392	6.9	42,299	12.4	49,000	14.4	2,046	3,112	4,449						
38	22,800	6.7	37,069	10.9	40,699	11.9	1,809	2,533	3,451	23,959	7.0	43,324	12.7	50,286	14.7	2,064	3,140	4,489						
39	23,400	6.9	38,045	11.2	41,770	12.2	1,866	2,613	3,560	24,526	7.2	44,349	13.0	51,572	15.1	2,082	3,168	4,529						
40	24,000	7.0	39,020	11.4	42,841	12.6	1,923	2,692	3,668	25,093	7.4	45,374	13.3	52,858	15.5	2,101	3,196	4,569						
41	24,600	7.2	39,996	11.7	43,912	12.9	1,980	2,772	3,776	25,660	7.5	46,399	13.6	54,144	15.9	2,119	3,224	4,609						
42	25,200	7.4	40,971	12.0	44,983	13.2	2,037	2,851	3,885	26,227	7.7	47,425	13.9	55,430	16.2	2,137	3,252	4,648						
43	25,800	7.6	41,947	12.3	46,054	13.5	2,093	2,931	3,993	26,794	7.9	48,450	14.2	56,716	16.6	2,156	3,280	4,688						
44	26,400	7.7	42,922	12.6	47,125	13.8	2,122	2,971	4,047	27,360	8.0	49,475	14.5	57,100	16.7	2,174	3,308	4,745						
45	27,000	7.9	43,898	12.9	48,196	14.1	2,150	3,010	4,102	27,927	8.2	50,500	14.8	57,712	16.9	2,211	3,365	4,802						
46	27,600	8.1	44,873	13.2	49,268	14.4	2,179	3,050	4,156	28,494	8.4	51,525	15.1	58,324	17.1	2,246	3,417	4,859						
47	28,200	8.3	45,849	13.4	50,339	14.8	2,207	3,090	4,210	29,061	8.5	52,550	15.4	58,936	17.3	2,299	3,498	4,917						
48	28,800	8.4	46,824	13.7	51,410	15.1	2,236	3,130	4,265	29,628	8.7	53,575	15.7	59,548	17.5	2,352	3,579	4,974						
49	29,400	8.6	47,800	14.0	52,481	15.4	2,264	3,170	4,319	30,195	8.8	54,600	16.0	60,159	17.6	2,406	3,660	5,031						
50	30,000	8.8	48,164	14.1	52,881	15.5	2,299	3,219	4,373	30,762	9.0	54,735	16.0	60,771	17.8	2,459	3,741	5,088						
51	30,600	9.0	48,529	14.2	53,281	15.6	2,335	3,269	4,428	31,329	9.2	54,870	16.1	61,383	18.0	2,512	3,822	5,145						
52	31,200	9.1	48,893	14.3	53,680	15.7	2,370	3,318	4,482	31,896	9.3	55,005	16.1	61,995	18.2	2,566	3,903	5,202						
53	31,800	9.3	49,257	14.4	54,080	15.9	2,405	3,367	4,537	32,462	9.5	55,140	16.2	62,607	18.3	2,579	3,924	5,259						
54	32,400	9.5	49,621	14.5	54,480	16.0	2,440	3,416	4,591	33,029	9.7	55,275	16.2	63,219	18.5	2,593	3,944	5,316						
55	33,000	9.7	49,986	14.6	54,880	16.1	2,476	3,466	4,645	33,596	9.8	55,410	16.2	63,831	18.7	2,606	3,964	5,373						
56	33,600	9.8	50,350	14.8	55,280	16.2	2,511	3,515	4,700	34,163	10.0	55,545	16.3	64,443	18.9	2,619	3,985	5,430						
57	34,200	10.0	50,714	14.9	55,680	16.3	2,546	3,564	4,754	34,730	10.2	55,680	16.3	65,054	19.1	2,633	4,005	5,487						
58	34,800	10.2	51,079	15.0	56,080	16.4	2,581	3,614	4,808	35,297	10.3	55,815	16.4	65,666	19.2	2,646	4,025	5,544						
59	35,400	10.4	51,443	15.1	56,480	16.6	2,616	3,663	4,863	35,864	10.5	55,950	16.4	66,278	19.4	2,659	4,046	5,601						
60	36,000	10.6	51,807	15.2	56,880	16.7	2,652	3,712	4,917	36,431	10.7	56,085	16.4	66,890	19.6	2,673	4,066	5,658						
61	36,600	10.7	52,171	15.3	57,280	16.8	2,687	3,761	4,971	36,997	10.8	56,220	16.5	67,502	19.8	2,686	4,086	5,715						
62	37,200	10.9	52,536	15.4	57,680	16.9	2,722	3,811	5,026	37,564	11.0	56,355	16.5	68,114	20.0	2,699	4,107	5,772						
63	37,800	11.1	52,900	15.5	58,080	17.0	2,757	3,860	5,080	38,131	11.2	56,500	16.6	68,726	17.3	2,734	4,160	5,170						

Примечание:

- Производительность охлаждения указана для следующих условий: температура в помещении 27 °Сст / 19 °Сст; температура наружного воздуха 35 °Сст
- Производительность нагрева указана для следующих условий: температура в помещении 20 °Сст; температура наружного воздуха 7 °Сст / 6 °Сст
- Номинальные производительности являются суммарными производительности внутренних блоков при постоянной частоте вращения инверторного компрессора.  
Эти значения производительности получены расчетным путем и должны использоваться в качестве справочной информации,
- Общая производительность внутренних блоков должна быть в диапазоне от 19 до 63 кБТЕ/ч (40%–130%)
- К наружному блоку должны быть подключены минимум два внутренних блока

# FM56AH

Суммарный индекс производительности внутренних блоков (тыс. БТЕ/ч)	Охлаждение /общая производительность/						Потребляемая мощность (Вт)			Нагрев /общая производительность/						Потребляемая мощность (Вт)		
	Минимум		Номинал		Максимум					Минимум		Номинал		Максимум				
	БТЕ/ч	кВт	БТЕ/ч	кВт	БТЕ/ч	кВт	Минимум	Номинал	Максимум	БТЕ/ч	кВт	БТЕ/ч	кВт	БТЕ/ч	кВт	Минимум	Номинал	Максимум
23	13,800	4.0	22,437	6.6	25,300	7.4	1,000	1,460	1,989	15,456	4.5	27,948	8.2	32,138	9.4	1,490	2,267	3,240
24	14,400	4.2	23,412	6.9	25,705	7.5	1,085	1,520	2,071	16,023	4.7	28,973	8.5	33,407	9.8	1,579	2,402	3,433
25	15,000	4.4	24,388	7.1	26,776	7.8	1,128	1,579	2,152	16,590	4.9	29,998	8.8	34,676	10.2	1,626	2,473	3,535
26	15,600	4.6	25,363	7.4	27,847	8.2	1,170	1,639	2,233	17,157	5.0	31,024	9.1	35,945	10.5	1,672	2,544	3,637
27	16,200	4.7	26,339	7.7	28,918	8.5	1,213	1,698	2,314	17,724	5.2	32,049	9.4	37,214	10.9	1,719	2,616	3,739
28	16,800	4.9	27,314	8.0	29,989	8.8	1,256	1,758	2,395	18,290	5.4	33,074	9.7	38,483	11.3	1,766	2,687	3,842
29	17,400	5.1	28,290	8.3	31,060	9.1	1,298	1,817	2,476	18,857	5.5	34,099	10.0	39,752	11.7	1,813	2,759	3,944
30	18,000	5.3	29,265	8.6	32,131	9.4	1,355	1,897	2,584	19,424	5.7	35,124	10.3	41,021	12.0	1,860	2,830	4,046
31	18,600	5.5	30,241	8.9	33,202	9.7	1,412	1,976	2,693	19,991	5.9	36,149	10.6	42,290	12.4	1,907	2,902	4,148
32	19,200	5.6	31,216	9.1	34,273	10.0	1,468	2,056	2,801	20,558	6.0	37,174	10.9	43,560	12.8	1,954	2,973	4,250
33	19,800	5.8	32,192	9.4	35,344	10.4	1,525	2,135	2,909	21,125	6.2	38,199	11.2	44,648	13.1	1,973	3,001	4,290
34	20,400	6.0	33,167	9.7	36,415	10.7	1,582	2,215	3,018	21,692	6.4	39,224	11.5	45,736	13.4	1,991	3,029	4,330
35	21,000	6.2	34,143	10.0	37,486	11.0	1,639	2,294	3,126	22,259	6.5	40,249	11.8	46,824	13.7	2,009	3,057	4,370
36	21,600	6.3	35,118	10.3	38,557	11.3	1,696	2,374	3,235	22,825	6.7	41,274	12.1	47,912	14.0	2,028	3,085	4,409
37	22,200	6.5	36,094	10.6	39,628	11.6	1,752	2,453	3,343	23,392	6.9	42,299	12.4	49,000	14.4	2,046	3,112	4,449
38	22,800	6.7	37,069	10.9	40,699	11.9	1,809	2,533	3,451	23,959	7.0	43,324	12.7	50,286	14.7	2,064	3,140	4,489
39	23,400	6.9	38,045	11.2	41,770	12.2	1,866	2,613	3,560	24,526	7.2	44,349	13.0	51,572	15.1	2,082	3,168	4,529
40	24,000	7.0	39,020	11.4	42,841	12.6	1,923	2,692	3,668	25,093	7.4	45,374	13.3	52,858	15.5	2,101	3,196	4,569
41	24,600	7.2	39,996	11.7	43,912	12.9	1,980	2,772	3,776	25,660	7.5	46,399	13.6	54,144	15.9	2,119	3,224	4,609
42	25,200	7.4	40,971	12.0	44,983	13.2	2,037	2,851	3,885	26,227	7.7	47,425	13.9	55,430	16.2	2,137	3,252	4,648
43	25,800	7.6	41,947	12.3	46,054	13.5	2,093	2,931	3,993	26,794	7.9	48,450	14.2	56,716	16.6	2,156	3,280	4,688
44	26,400	7.7	42,922	12.6	47,125	13.8	2,122	2,971	4,047	27,360	8.0	49,475	14.5	58,000	17.0	2,174	3,308	4,728
45	27,000	7.9	43,898	12.9	48,196	14.1	2,150	3,010	4,102	27,927	8.2	50,500	14.8	59,282	17.1	2,211	3,365	4,812
46	27,600	8.1	44,873	13.2	49,268	14.4	2,179	3,050	4,156	28,494	8.4	51,525	15.1	60,564	17.2	2,246	3,417	4,884
47	28,200	8.3	45,849	13.4	50,339	14.8	2,207	3,090	4,210	29,061	8.5	52,550	15.4	61,848	17.3	2,299	3,498	5,000
48	28,800	8.4	46,824	13.7	51,410	15.1	2,236	3,130	4,265	29,628	8.7	53,575	15.7	63,132	17.3	2,352	3,579	5,116
49	29,400	8.6	47,800	14.0	52,481	15.4	2,264	3,170	4,319	30,195	8.8	54,600	16.0	64,416	17.4	2,406	3,660	5,232
50	30,000	8.8	48,776	14.1	53,552	15.5	2,299	3,219	4,373	30,762	9.0	55,625	16.1	65,700	17.5	2,459	3,741	5,348
51	30,600	9.0	49,751	14.2	54,623	15.6	2,335	3,269	4,428	31,329	9.2	56,650	16.2	67,000	17.7	2,512	3,822	5,464
52	31,200	9.1	50,727	14.3	55,694	15.7	2,370	3,318	4,482	31,896	9.3	57,675	16.3	68,300	17.9	2,566	3,903	5,580
53	31,800	9.3	51,702	14.4	56,765	15.9	2,405	3,367	4,537	32,463	9.5	58,700	16.4	69,600	17.9	2,579	3,924	5,609
54	32,400	9.5	52,677	14.5	57,836	16.0	2,440	3,416	4,591	33,029	9.7	59,725	16.5	70,900	18.0	2,593	3,944	5,638
55	33,000	9.7	53,652	14.6	58,907	16.1	2,476	3,466	4,645	33,596	9.8	60,750	16.6	72,200	18.0	2,606	3,964	5,667
56	33,600	9.8	54,627	14.8	59,978	16.2	2,511	3,515	4,700	34,163	10.0	61,775	16.7	73,500	18.1	2,619	3,985	5,696
57	34,200	10.0	55,602	14.9	61,049	16.3	2,546	3,564	4,754	34,730	10.2	62,800	16.8	74,800	18.1	2,633	4,005	5,725
58	34,800	10.2	56,577	15.0	62,120	16.4	2,581	3,614	4,808	35,297	10.3	63,825	16.9	76,100	18.2	2,646	4,025	5,754
59	35,400	10.4	57,552	15.1	63,191	16.6	2,616	3,663	4,863	35,864	10.5	64,850	17.0	77,400	18.2	2,659	4,046	5,783
60	36,000	10.6	58,527	15.2	64,262	16.7	2,652	3,712	4,917	36,431	10.7	65,875	17.1	78,700	18.3	2,673	4,066	5,812
61	36,600	10.7	59,502	15.3	65,333	16.8	2,687	3,761	4,971	36,997	10.8	66,900	17.2	80,000	18.3	2,686	4,086	5,841
62	37,200	10.9	60,477	15.4	66,404	16.9	2,722	3,811	5,026	37,564	11.0	67,925	17.3	81,300	18.4	2,699	4,107	5,870
63	37,800	11.1	61,452	15.5	67,475	17.0	2,757	3,860	5,080	38,131	11.2	68,950	17.4	82,600	18.4	2,734	4,160	5,900
64	38,400	11.3	62,427	15.6	68,546	17.2	2,776	3,887	5,158	38,698	11.3	69,975	17.5	83,900	18.5	2,726	4,147	5,929
65	39,000	11.4	63,402	15.7	69,617	17.3	2,795	3,913	5,236	39,265	11.5	70,999	17.5	85,200	18.5	2,739	4,168	5,958
66	39,600	11.6	64,377	15.8	70,688	17.5	2,814	3,940	5,314	39,832	11.7	72,024	17.6	86,500	18.5	2,753	4,188	5,987
67	40,200	11.8	65,352	15.9	71,759	17.6	2,833	3,966	5,392	40,399	11.8	73,049	17.7	87,800	18.6	2,766	4,208	6,016
68	40,800	12.0	66,327	16.0	72,830	17.8	2,852	3,993	5,470	40,966	12.0	74,074	17.8	89,100	18.6	2,780	4,229	6,045
69	41,400	12.1	67,302	16.1	73,901	17.9	2,871	4,019	5,548	41,532	12.2	75,099	17.8	90,400	18.6	2,793	4,249	6,074
70	42,000	12.3	68,277	16.3	74,972	18.1	2,890	4,046	5,626	42,099	12.3	76,124	17.9	91,700	18.7	2,806	4,269	6,103
71	42,600	12.5	69,252	16.4	76,043	18.2	2,909	4,072	5,704	42,666	12.5	77,149	18.0	93,000	18.7	2,820	4,290	6,132
72	43,200	12.7	70,227	16.5	77,114	18.4	2,928	4,099	5,782	43,233	12.7	78,174	18.0	94,300	18.7	2,833	4,310	6,161
73	43,800	12.8	71,202	16.6	78,185	18.5	2,947	4,126	5,860	43,800	12.8	79,199	18.1	95,600	18.8	2,846	4,330	6,190

Примечание:

- Производительность охлаждения указана для следующих условий: температура в помещении 27 °Сст / 19 °Сст; температура наружного воздуха 35 °Сст
- Производительность нагрева указана для следующих условий: температура в помещении 20 °Сст; температура наружного воздуха 7 °Сст / 6 °Сст
- Номинальные производительности являются суммарными производительностями внутренних блоков при постоянной частоте вращения инверторного компрессора. Эти значения производительности получены расчетным путем и должны использоваться в качестве справочной информации.
- Общая производительность внутренних блоков должна быть в диапазоне от 23 до 73 кВт/ч (40%–130%)
- К наружному блоку должны быть подключены минимум два внутренних блока.



Суммарный индекс производительности внутренних блоков (тыс. БТЕ/ч)	Охлаждение /общая производительность/						Потребляемая мощность (Вт)			Нагрев /общая производительность/						Потребляемая мощность (Вт)		
	Минимум		Номинал		Максимум					Минимум		Номинал		Максимум				
	БТЕ/ч	кВт	БТЕ/ч	кВт	БТЕ/ч	кВт	Минимум	Номинал	Максимум	БТЕ/ч	кВт	БТЕ/ч	кВт	БТЕ/ч	кВт	Минимум	Номинал	Максимум
16	9,600	2.8	16,955	5.0	18,513	5.4	800	844	1,279	10,752	3	21,633	6	25,188	7	890	1,066	1,162
18	10,500	3.1	17,759	5.2	19,707	5.8	833	899	1,347	11,760	3	22,407	7	25,913	8	931	1,116	1,258
19	11,400	3.3	18,563	5.4	20,900	6.1	866	953	1,415	12,768	4	23,182	7	26,637	8	972	1,166	1,354
20	12,000	3.5	19,367	5.7	21,741	6.4	898	1,008	1,483	13,440	4	23,956	7	27,362	8	1,013	1,216	1,450
21	12,600	3.7	20,171	5.9	22,582	6.6	931	1,063	1,550	14,112	4	24,731	7	28,087	8	1,055	1,265	1,547
22	13,200	3.9	20,975	6.1	23,423	6.9	964	1,117	1,618	14,784	4	25,505	7	28,811	8	1,096	1,315	1,643
23	13,800	4.0	21,779	6.4	24,264	7.1	997	1,172	1,686	15,456	5	26,279	8	29,536	9	1,137	1,365	1,739
24	14,400	4.2	22,583	6.6	25,105	7.4	1,029	1,227	1,754	16,023	5	27,054	8	30,261	9	1,178	1,415	1,835
25	15,000	4.4	23,387	6.9	25,946	7.6	1,062	1,281	1,822	16,590	5	27,828	8	30,985	9	1,219	1,465	1,931
26	15,600	4.6	24,191	7.1	26,787	7.9	1,095	1,336	1,890	17,157	5	28,602	8	31,710	9	1,260	1,515	2,027
27	16,200	4.7	24,995	7.3	27,628	8.1	1,128	1,391	1,958	17,724	5	29,377	9	32,434	10	1,301	1,564	2,124
28	16,800	4.9	25,799	7.6	28,469	8.3	1,160	1,445	2,026	18,290	5	30,151	9	33,159	10	1,342	1,614	2,220
29	17,400	5.1	26,603	7.8	29,310	8.6	1,193	1,500	2,093	18,857	6	30,926	9	33,884	10	1,384	1,664	2,316
30	18,000	5.3	27,407	8.0	30,151	8.8	1,226	1,555	2,161	19,424	6	31,700	9	34,608	10	1,425	1,714	2,412
31	18,600	5.5	28,211	8.3	30,992	9.1	1,259	1,610	2,229	19,991	6	32,474	10	35,333	10	1,466	1,764	2,508
32	19,200	5.6	29,015	8.5	31,833	9.3	1,291	1,664	2,297	20,558	6	33,249	10	36,058	11	1,507	1,814	2,604
33	19,800	5.8	29,819	8.7	32,674	9.6	1,324	1,719	2,365	21,125	6	34,023	10	36,782	11	1,548	1,863	2,701
34	20,400	6.0	30,622	9.0	33,515	9.8	1,357	1,774	2,433	21,692	6	34,797	10	37,507	11	1,589	1,913	2,797
35	21,000	6.2	31,426	9.2	34,355	10.1	1,390	1,828	2,501	22,259	7	35,572	10	38,232	11	1,630	1,963	2,893
36	21,600	6.3	32,230	9.4	35,196	10.3	1,422	1,883	2,568	22,825	7	36,346	11	38,956	11	1,672	2,013	2,989
37	22,200	6.5	33,034	9.7	36,037	10.6	1,455	1,938	2,636	23,392	7	37,121	11	39,681	12	1,713	2,063	3,085
38	22,800	6.7	33,838	9.9	36,878	10.8	1,488	1,992	2,704	23,959	7	37,895	11	40,406	12	1,754	2,113	3,181
39	23,400	6.9	34,642	10.2	37,719	11.1	1,521	2,047	2,772	24,526	7	38,669	11	41,130	12	1,795	2,162	3,278
40	24,000	7.0	35,446	10.4	38,560	11.3	1,553	2,102	2,840	25,093	7	39,444	12	41,855	12	1,836	2,212	3,374
41	24,600	7.2	36,250	10.6	39,401	11.5	1,586	2,156	2,908	25,660	8	40,218	12	42,580	12	1,877	2,262	3,470
42	25,200	7.4	37,054	10.9	40,242	11.8	1,619	2,211	2,976	26,227	8	40,992	12	43,304	13	1,918	2,312	3,566
43	25,800	7.6	37,858	11.0	41,083	12.0	1,652	2,237	3,043	26,794	8	41,236	12	44,029	13	1,960	2,345	3,662
44	26,400	7.7	38,413	11.3	41,924	12.3	1,684	2,262	3,111	27,360	8	41,480	12	44,754	13	2,001	2,377	3,758
45	27,000	7.9	39,134	11.5	42,765	12.5	1,717	2,288	3,179	27,927	8	41,724	12	45,478	13	2,042	2,410	3,855
46	27,600	8.1	39,400	11.5	43,606	12.8	1,750	2,313	3,247	28,494	8	41,968	12	46,203	14	2,083	2,442	3,951
47	28,200	8.3	40,019	11.7	44,447	13.0	1,783	2,339	3,315	29,061	9	42,212	12	46,927	14	2,124	2,475	4,047
48	28,800	8.4	40,740	11.9	45,288	13.3	1,815	2,364	3,383	29,628	9	42,456	12	47,652	14	2,165	2,507	4,143
49	29,400	8.6	41,300	12.1	46,129	13.5	1,848	2,390	3,451	30,195	9	42,700	13	48,377	14	2,206	2,540	4,239
50	30,000	8.8	41,440	12.1	46,503	13.6	1,881	2,416	3,519	30,762	9	42,870	13	49,101	14	2,247	2,573	4,335
51	30,600	9.0	41,580	12.2	46,877	13.7	1,914	2,442	3,586	31,329	9	43,040	13	49,826	15	2,289	2,606	4,432
52	31,200	9.1	41,720	12.2	47,252	13.8	1,946	2,468	3,654	31,896	9	43,210	13	50,551	15	2,330	2,639	4,528
53	31,800	9.3	41,860	12.3	47,626	14.0	1,979	2,494	3,722	32,462	10	43,380	13	51,275	15	2,371	2,672	4,624
54	32,400	9.5	42,000	12.3	48,000	14.1	2,012	2,520	3,790	33,029	10	43,550	13	52,000	15	2,412	2,705	4,720

Примечание:

1. Производительность охлаждения указана для следующих условий: температура в помещении 27 °Сст / 19 °Сст; температура наружного воздуха 35 °Сст
2. Производительность нагрева указана для следующих условий: температура в помещении 20 °Сст; температура наружного воздуха 7 °Сст / 6 °Сст
3. Номинальные производительности являются суммарными производительности внутренних блоков при постоянной частоте вращения инверторного компрессора. Эти значения производительности получены расчетным путем и должны использоваться в качестве справочной информации.
4. Общая производительность внутренних блоков должна быть в диапазоне от 16 до 54 кВт/ч (40%–130%)
5. К наружному блоку должны быть подключены минимум два внутренних блока.



Суммарный индекс производительности внутренних блоков (тыс. БТЕ/ч)	Охлаждение /общая производительность/						Потребляемая мощность (Вт)			Нагрев /общая производительность/						Потребляемая мощность (Вт)		
	Минимум		Номинал		Максимум		Минимум	Номинал	Максимум	Минимум		Номинал		Максимум		Минимум	Номинал	Максимум
	БТЕ/ч	кВт	БТЕ/ч	кВт	БТЕ/ч	кВт				БТЕ/ч	кВт	БТЕ/ч	кВт	БТЕ/ч	кВт			
19	11,400	3.3	18,535	5.4	20,900	6.1	840	1,222	1,665	12,768	3.7	23,088	6.8	27,365	8.0	1,300	1,728	2,470
20	12,000	3.5	19,510	5.7	22,000	6.4	880	1,282	1,746	13,440	3.9	24,303	7.1	28,482	8.3	1,348	1,863	2,663
21	12,600	3.7	20,486	6.0	23,100	6.8	920	1,341	1,827	14,112	4.1	25,518	7.5	29,600	8.7	1,395	1,997	2,855
22	13,200	3.9	21,461	6.3	24,200	7.1	960	1,401	1,908	14,784	4.3	26,733	7.8	30,869	9.0	1,443	2,132	3,048
23	13,800	4.0	22,437	6.6	25,300	7.4	1,000	1,460	1,989	15,456	4.5	27,948	8.2	32,138	9.4	1,490	2,267	3,240
24	14,400	4.2	23,412	6.9	25,705	7.5	1,085	1,520	2,071	16,023	4.7	28,973	8.5	33,407	9.8	1,579	2,402	3,433
25	15,000	4.4	24,388	7.1	26,776	7.8	1,128	1,579	2,152	16,590	4.9	29,998	8.8	34,676	10.2	1,626	2,473	3,535
26	15,600	4.6	25,363	7.4	27,847	8.2	1,170	1,639	2,233	17,157	5.0	31,024	9.1	35,945	10.5	1,672	2,544	3,637
27	16,200	4.7	26,339	7.7	28,918	8.5	1,213	1,698	2,314	17,724	5.2	32,049	9.4	37,214	10.9	1,719	2,616	3,739
28	16,800	4.9	27,314	8.0	29,989	8.8	1,256	1,758	2,395	18,290	5.4	33,074	9.7	38,483	11.3	1,766	2,687	3,842
29	17,400	5.1	28,290	8.3	31,060	9.1	1,298	1,817	2,476	18,857	5.5	34,099	10.0	39,752	11.7	1,813	2,759	3,944
30	18,000	5.3	29,265	8.6	32,131	9.4	1,355	1,897	2,584	19,424	5.7	35,124	10.3	41,021	12.0	1,860	2,830	4,046
31	18,600	5.5	30,241	8.9	33,202	9.7	1,412	1,976	2,693	19,991	5.9	36,149	10.6	42,290	12.4	1,907	2,902	4,148
32	19,200	5.6	31,216	9.1	34,273	10.0	1,468	2,056	2,801	20,558	6.0	37,174	10.9	43,560	12.8	1,954	2,973	4,250
33	19,800	5.8	32,192	9.4	35,344	10.4	1,525	2,135	2,909	21,125	6.2	38,199	11.2	44,648	13.1	1,973	3,001	4,290
34	20,400	6.0	33,167	9.7	36,415	10.7	1,582	2,215	3,018	21,692	6.4	39,224	11.5	45,736	13.4	1,991	3,029	4,330
35	21,000	6.2	34,143	10.0	37,486	11.0	1,639	2,294	3,126	22,259	6.5	40,249	11.8	46,824	13.7	2,009	3,057	4,370
36	21,600	6.3	35,118	10.3	38,557	11.3	1,696	2,374	3,235	22,825	6.7	41,274	12.1	47,912	14.0	2,028	3,085	4,409
37	22,200	6.5	36,094	10.6	39,628	11.6	1,752	2,453	3,343	23,392	6.9	42,299	12.4	49,000	14.4	2,046	3,112	4,449
38	22,800	6.7	37,069	10.9	40,699	11.9	1,809	2,533	3,451	23,959	7.0	43,324	12.7	50,286	14.7	2,064	3,140	4,489
39	23,400	6.9	38,045	11.2	41,770	12.2	1,866	2,613	3,560	24,526	7.2	44,349	13.0	51,572	15.1	2,082	3,168	4,529
40	24,000	7.0	39,020	11.4	42,841	12.6	1,923	2,692	3,668	25,093	7.4	45,374	13.3	52,858	15.5	2,101	3,196	4,569
41	24,600	7.2	39,996	11.7	43,912	12.9	1,980	2,772	3,776	25,660	7.5	46,399	13.6	54,144	15.9	2,119	3,224	4,609
42	25,200	7.4	40,971	12.0	44,983	13.2	2,037	2,851	3,885	26,227	7.7	47,425	13.9	55,430	16.2	2,137	3,252	4,648
43	25,800	7.6	41,947	12.3	46,054	13.5	2,093	2,931	3,993	26,794	7.9	48,450	14.2	56,716	16.6	2,156	3,280	4,688
44	26,400	7.7	42,922	12.6	47,125	13.8	2,122	2,971	4,047	27,360	8.0	49,475	14.5	57,100	16.7	2,174	3,308	4,745
45	27,000	7.9	43,898	12.9	48,196	14.1	2,150	3,010	4,102	27,927	8.2	50,500	14.8	57,712	16.9	2,211	3,365	4,802
46	27,600	8.1	44,873	13.2	49,268	14.4	2,179	3,050	4,156	28,494	8.4	51,525	15.1	58,324	17.1	2,246	3,417	4,859
47	28,200	8.3	45,849	13.4	50,339	14.8	2,207	3,090	4,210	29,061	8.5	52,550	15.4	58,936	17.3	2,299	3,498	4,917
48	28,800	8.4	46,824	13.7	51,410	15.1	2,236	3,130	4,265	29,628	8.7	53,575	15.7	59,548	17.5	2,352	3,579	4,974
49	29,400	8.6	47,800	14.0	52,481	15.4	2,264	3,170	4,319	30,195	8.8	54,600	16.0	60,159	17.6	2,406	3,660	5,031
50	30,000	8.8	48,164	14.1	52,881	15.5	2,299	3,219	4,373	30,762	9.0	54,735	16.0	60,771	17.8	2,459	3,741	5,088
51	30,600	9.0	48,529	14.2	53,281	15.6	2,335	3,269	4,428	31,329	9.2	54,870	16.1	61,383	18.0	2,512	3,822	5,145
52	31,200	9.1	48,893	14.3	53,680	15.7	2,370	3,318	4,482	31,896	9.3	55,005	16.1	61,995	18.2	2,566	3,903	5,202
53	31,800	9.3	49,257	14.4	54,080	15.9	2,405	3,367	4,537	32,462	9.5	55,140	16.2	62,607	18.3	2,579	3,924	5,259
54	32,400	9.5	49,621	14.5	54,480	16.0	2,440	3,416	4,591	33,029	9.7	55,275	16.2	63,219	18.5	2,593	3,944	5,316
55	33,000	9.7	49,986	14.6	54,880	16.1	2,476	3,466	4,645	33,596	9.8	55,410	16.2	63,831	18.7	2,606	3,964	5,373
56	33,600	9.8	50,350	14.8	55,280	16.2	2,511	3,515	4,700	34,163	10.0	55,545	16.3	64,443	18.9	2,619	3,985	5,430
57	34,200	10.0	50,714	14.9	55,680	16.3	2,546	3,564	4,754	34,730	10.2	55,680	16.3	65,054	19.1	2,633	4,005	5,487
58	34,800	10.2	51,079	15.0	56,080	16.4	2,581	3,614	4,808	35,297	10.3	55,815	16.4	65,666	19.2	2,646	4,025	5,544
59	35,400	10.4	51,443	15.1	56,480	16.6	2,616	3,663	4,863	35,864	10.5	55,950	16.4	66,278	19.4	2,659	4,046	5,601
60	36,000	10.6	51,807	15.2	56,880	16.7	2,652	3,712	4,917	36,431	10.7	56,085	16.4	66,890	19.6	2,673	4,066	5,658
61	36,600	10.7	52,171	15.3	57,280	16.8	2,687	3,761	4,971	36,997	10.8	56,220	16.5	67,502	19.8	2,686	4,086	5,715
62	37,200	10.9	52,536	15.4	57,680	16.9	2,722	3,811	5,026	37,564	11.0	56,355	16.5	68,114	20.0	2,699	4,107	5,772
63	37,800	11.1	52,900	15.5	58,080	17.0	2,757	3,860	5,080	38,131	11.2	56,500	16.6	68,726	17.3	2,734	4,160	5,170

Примечание:

1. Производительность охлаждения указана для следующих условий: температура в помещении 27 °Сст / 19 °Сст; температура наружного воздуха 35 °Сст
2. Производительность нагрева указана для следующих условий: температура в помещении 20 °Сст; температура наружного воздуха 7 °Сст / 6 °Сст
3. Номинальные производительности являются суммарными производительностями внутренних блоков при постоянной частоте вращения инверторного компрессора. Эти значения производительности получены расчетным путем и должны использоваться в качестве справочной информации.
4. Общая производительность внутренних блоков должна быть в диапазоне от 19 до 63 кВт/ч (40%–130%)
5. К наружному блоку должны быть подключены минимум два внутренних блока.



Суммарный индекс производительности внутренних блоков (тыс. БТЕ/ч)	Охлаждение /общая производительность/						Потребляемая мощность (Вт)			Нагрев /общая производительность/						Потребляемая мощность (Вт)		
	Минимум		Номинал		Максимум					Минимум		Номинал		Максимум				
	БТЕ/ч	кВт	БТЕ/ч	кВт	БТЕ/ч	кВт	Минимум	Номинал	Максимум	БТЕ/ч	кВт	БТЕ/ч	кВт	БТЕ/ч	кВт	Минимум	Номинал	Максимум
23	13,800	4.0	22,437	6.6	25,300	7.4	1,000	1,460	1,989	15,456	4.5	27,948	8.2	32,138	9.4	1,490	2,267	3,240
24	14,400	4.2	23,412	6.9	25,705	7.5	1,085	1,520	2,071	16,023	4.7	28,973	8.5	33,407	9.8	1,579	2,402	3,433
25	15,000	4.4	24,388	7.1	26,776	7.8	1,128	1,579	2,152	16,590	4.9	29,998	8.8	34,676	10.2	1,626	2,473	3,535
26	15,600	4.6	25,363	7.4	27,847	8.2	1,170	1,639	2,233	17,157	5.0	31,024	9.1	35,945	10.5	1,672	2,544	3,637
27	16,200	4.7	26,339	7.7	28,918	8.5	1,213	1,698	2,314	17,724	5.2	32,049	9.4	37,214	10.9	1,719	2,616	3,739
28	16,800	4.9	27,314	8.0	29,989	8.8	1,256	1,758	2,395	18,290	5.4	33,074	9.7	38,483	11.3	1,766	2,687	3,842
29	17,400	5.1	28,290	8.3	31,060	9.1	1,298	1,817	2,476	18,857	5.5	34,099	10.0	39,752	11.7	1,813	2,759	3,944
30	18,000	5.3	29,265	8.6	32,131	9.4	1,355	1,897	2,584	19,424	5.7	35,124	10.3	41,021	12.0	1,860	2,830	4,046
31	18,600	5.5	30,241	8.9	33,202	9.7	1,412	1,976	2,693	19,991	5.9	36,149	10.6	42,290	12.4	1,907	2,902	4,148
32	19,200	5.6	31,216	9.1	34,273	10.0	1,468	2,056	2,801	20,558	6.0	37,174	10.9	43,560	12.8	1,954	2,973	4,250
33	19,800	5.8	32,192	9.4	35,344	10.4	1,525	2,135	2,909	21,125	6.2	38,199	11.2	44,848	13.1	1,973	3,001	4,290
34	20,400	6.0	33,167	9.7	36,415	10.7	1,582	2,215	3,018	21,692	6.4	39,224	11.5	45,736	13.4	1,991	3,029	4,330
35	21,000	6.2	34,143	10.0	37,486	11.0	1,639	2,294	3,126	22,259	6.5	40,249	11.8	46,824	13.7	2,009	3,057	4,370
36	21,600	6.3	35,118	10.3	38,557	11.3	1,696	2,374	3,235	22,825	6.7	41,274	12.1	47,912	14.0	2,028	3,085	4,409
37	22,200	6.5	36,094	10.6	39,628	11.6	1,752	2,453	3,343	23,392	6.9	42,299	12.4	49,000	14.4	2,046	3,112	4,449
38	22,800	6.7	37,069	10.9	40,699	11.9	1,809	2,533	3,451	23,959	7.0	43,324	12.7	50,286	14.7	2,064	3,140	4,489
39	23,400	6.9	38,045	11.2	41,770	12.2	1,866	2,613	3,560	24,526	7.2	44,349	13.0	51,572	15.1	2,082	3,168	4,529
40	24,000	7.0	39,020	11.4	42,841	12.6	1,923	2,692	3,668	25,093	7.4	45,374	13.3	52,858	15.5	2,101	3,196	4,569
41	24,600	7.2	39,996	11.7	43,912	12.9	1,980	2,772	3,776	25,660	7.5	46,399	13.6	54,144	15.9	2,119	3,224	4,609
42	25,200	7.4	40,971	12.0	44,983	13.2	2,037	2,851	3,885	26,227	7.7	47,425	13.9	55,430	16.2	2,137	3,252	4,648
43	25,800	7.6	41,947	12.3	46,054	13.5	2,093	2,931	3,993	26,794	7.9	48,450	14.2	56,716	16.6	2,156	3,280	4,688
44	26,400	7.7	42,922	12.6	47,125	13.8	2,122	2,971	4,047	27,360	8.0	49,475	14.5	58,000	17.0	2,174	3,308	4,728
45	27,000	7.9	43,898	12.9	48,196	14.1	2,150	3,010	4,102	27,927	8.2	50,500	14.8	58,292	17.1	2,211	3,365	4,812
46	27,600	8.1	44,873	13.2	49,268	14.4	2,179	3,050	4,156	28,494	8.4	51,525	15.1	58,584	17.2	2,246	3,417	4,884
47	28,200	8.3	45,849	13.4	50,339	14.8	2,207	3,090	4,210	29,061	8.5	52,550	15.4	58,876	17.3	2,299	3,498	5,000
48	28,800	8.4	46,824	13.7	51,410	15.1	2,236	3,130	4,265	29,628	8.7	53,575	15.7	59,168	17.3	2,352	3,579	5,116
49	29,400	8.6	47,800	14.0	52,481	15.4	2,264	3,170	4,319	30,195	8.8	54,600	16.0	59,460	17.4	2,406	3,660	5,232
50	30,000	8.8	48,776	14.1	52,881	15.5	2,299	3,219	4,373	30,762	9.0	54,943	16.1	59,750	17.5	2,459	3,741	5,348
51	30,600	9.0	48,529	14.2	53,281	15.6	2,335	3,269	4,428	31,329	9.2	55,286	16.2	60,375	17.7	2,512	3,822	5,464
52	31,200	9.1	48,893	14.3	53,680	15.7	2,370	3,318	4,482	31,896	9.3	55,629	16.3	61,000	17.9	2,566	3,903	5,580
53	31,800	9.3	49,257	14.4	54,080	15.9	2,405	3,367	4,537	32,462	9.5	55,971	16.4	61,176	17.9	2,579	3,924	5,609
54	32,400	9.5	49,621	14.5	54,480	16.0	2,440	3,416	4,591	33,029	9.7	56,314	16.5	61,353	18.0	2,593	3,944	5,638
55	33,000	9.7	49,986	14.6	54,880	16.1	2,476	3,466	4,645	33,596	9.8	56,657	16.6	61,529	18.0	2,606	3,964	5,667
56	33,600	9.8	50,350	14.8	55,280	16.2	2,511	3,515	4,700	34,163	10.0	57,000	16.7	61,706	18.1	2,619	3,985	5,696
57	34,200	10.0	50,714	14.9	55,680	16.3	2,546	3,564	4,754	34,730	10.2	57,343	16.8	61,882	18.1	2,633	4,005	5,725
58	34,800	10.2	51,079	15.0	56,080	16.4	2,581	3,614	4,808	35,297	10.3	57,686	16.9	62,059	18.2	2,646	4,025	5,754
59	35,400	10.4	51,443	15.1	56,480	16.6	2,616	3,663	4,863	35,864	10.5	58,029	17.0	62,235	18.2	2,659	4,046	5,783
60	36,000	10.6	51,807	15.2	56,880	16.7	2,652	3,712	4,917	36,431	10.7	58,371	17.1	62,412	18.3	2,673	4,066	5,812
61	36,600	10.7	52,171	15.3	57,280	16.8	2,687	3,761	4,971	36,997	10.8	58,714	17.2	62,588	18.3	2,686	4,086	5,841
62	37,200	10.9	52,536	15.4	57,680	16.9	2,722	3,811	5,026	37,564	11.0	59,057	17.3	62,765	18.4	2,699	4,107	5,870
63	37,800	11.1	52,900	15.5	58,080	17.0	2,757	3,860	5,080	38,131	11.2	59,400	17.4	62,941	18.4	2,734	4,160	5,900
64	38,400	11.3	53,264	15.6	58,592	17.2	2,776	3,887	5,158	38,698	11.3	59,636	17.5	63,047	18.5	2,726	4,147	5,929
65	39,000	11.4	53,628	15.7	59,104	17.3	2,795	3,913	5,236	39,265	11.5	59,872	17.5	63,153	18.5	2,739	4,168	5,958
66	39,600	11.6	53,992	15.8	59,616	17.5	2,814	3,940	5,314	39,832	11.7	60,108	17.6	63,259	18.5	2,753	4,188	5,987
67	40,200	11.8	54,356	15.9	60,128	17.6	2,833	3,966	5,392	40,399	11.8	60,344	17.7	63,365	18.6	2,766	4,208	6,016
68	40,800	12.0	54,720	16.0	60,640	17.8	2,852	3,993	5,470	40,966	12.0	60,580	17.8	63,471	18.6	2,780	4,229	6,045
69	41,400	12.1	55,084	16.1	61,152	17.9	2,871	4,019	5,548	41,532	12.2	60,816	17.8	63,576	18.6	2,793	4,249	6,074
70	42,000	12.3	55,448	16.3	61,664	18.1	2,890	4,046	5,626	42,099	12.3	61,052	17.9	63,682	18.7	2,806	4,269	6,103
71	42,600	12.5	55,812	16.4	62,176	18.2	2,909	4,072	5,704	42,666	12.5	61,288	18.0	63,788	18.7	2,820	4,290	6,132
72	43,200	12.7	56,176	16.5	62,688	18.4	2,928	4,099	5,782	43,233	12.7	61,524	18.0	63,894	18.7	2,833	4,310	6,161
73	43,800	12.8	56,540	16.6	63,200	18.5	2,947	4,126	5,860	43,800	12.8	61,760	18.1	64,000	18.8	2,846	4,330	6,190

Примечание:

1. Производительность охлаждения указана для следующих условий: температура в помещении 27 °Сст / 19 °Сст; температура наружного воздуха 35 °Сст
2. Производительность нагрева указана для следующих условий: температура в помещении 20 °Сст; температура наружного воздуха 7 °Сст / 6 °Сст
3. Номинальные производительности являются суммарными производительностями внутренних блоков при постоянной частоте вращения инверторного компрессора. Эти значения производительности получены расчетным путем и должны использоваться в качестве справочной информации.
4. Общая производительность внутренних блоков должна быть в диапазоне от 23 до 73 кВт/ч (40%–130%)
5. К наружному блоку должны быть подключены минимум два внутренних блока.