

# PROMAX-12

## QAM ANALYSER



## SAFETY NOTES

Read the user's manual before using the equipment, mainly "SAFETY RULES" paragraph.

The symbol  on the equipment means "SEE USER'S MANUAL". In this manual may also appear as a Caution or Warning symbol.

**WARNING AND CAUTION** statements may appear in this manual to avoid injury hazard or damage to this product or other property.

## USER'S MANUAL VERSION

Version	Date	Firmware Version
2.2	June 2016	1.32
		PC Software Version
		1.07

## What's new in User's Manual

- v2.2: Several improvements. New option for editing channels.
- v2.1: Change in voltage specification.
- v2.0: New graphic in annex.
- v2.0: Mistakes correction.
- v2.0: Settings change (system).
- v2.0: Available option: DVB-T (COFDM).
- v1.2: Added ATTENUATION option in settings.

## SAFETY RULES

- \* **The safety could not be assured if the instructions for use are not closely followed.**
- \* Use this equipment connected only to devices or systems with their common at ground potential.
- \* This equipment can be used in **Over-Voltage Category I** installations and **Pollution Degree 2** environments.
- \* Use the mains adapter in **Over-Voltage Category II** installations and **Pollution Degree 1** environments. It is for **INDOOR USE**.
- \* When using some of the following accessories use only the specified ones to ensure safety.

Power adapter.

Mains cable.















- \* Observe all **specified ratings** both of supply and measurement.
- \* Use this instrument under the **specified environmental** conditions.
- \* **The user is not authorised to manipulate inside the instrument:**
  - Any change on the equipment should be carried out by qualified personnel.
- \* Follow the **cleaning instructions** described in the Maintenance paragraph.

### CAUTION:



The battery used can present danger of fire or chemical burn if it is severely mistreat. Do not disassembly, cremate or heat the battery above 100 °C under no circumstances.

\* Symbols related with safety:

	DIRECT CURRENT		ON (Supply)
	ALTERNATING CURRENT		OFF (Supply)
	DIRECT AND ALTERNATING		DOUBLE INSULATION (Class II protection)
	GROUND TERMINAL		CAUTION (Risk of electric shock)
	PROTECTIVE CONDUCTOR		CAUTION REFER TO MANUAL
	FRAME TERMINAL		FUSE
	EQUIPOTENTIALITY		EQUIPMENT OR COMPONENT TO BE RECYCLED
			

### Descriptive Examples of Over-Voltage Categories

**Cat I** Low voltage installations isolated from the mains.

**Cat II** Portable domestic installations.

**Cat III** Fixed domestic installations.

**Cat IV** Industrial installations.

## TABLE OF CONTENTS

<b>1 GENERAL</b> .....	<b>1-1</b>
1.1 Description .....	1-1
<b>2 SETTING UP</b> .....	<b>2-3</b>
2.1 Package Content .....	2-3
2.2 Power supply .....	2-4
2.2.1 Battery charge .....	2-4
2.2.2 Recommendations for using .....	2-5
2.3 Installation and start-up .....	2-5
2.3.1 Contrast adjustment .....	2-5
2.4 Equipment Details .....	2-6
<b>3 OPERATING INSTRUCTIONS</b> .....	<b>3-8</b>
3.1 Operating instructions and Navigation .....	3-8
3.2 Global configuration menu .....	3-11
3.2.1 Edit Channel Plan .....	3-13
3.3 SCAN operating mode .....	3-14
3.3.1 SCAN mode configuration .....	3-17
3.4 CHANNEL-FREQUENCY operating mode .....	3-18
3.4.1 Channel tuning .....	3-20
3.4.1.1 Video carrier measurement (analogue channels) .....	3-20
3.4.1.2 Audio carrier measurement (analogue channels) .....	3-21
3.4.1.3 Distortion products measurement (analogue channels) .....	3-21
3.4.1.4 Measurement of DVB-C / DVB-T / DAB (digital channels) .....	3-24
3.4.1.5 Constellation Diagram (digital channels) .....	3-26
3.4.1.6 Channel tuning configuration .....	3-27
3.4.2 Frequency Tuning .....	3-30
3.4.2.1 Level Mode .....	3-31
3.4.2.2 Analogue Mode .....	3-31
3.4.2.3 Digital Mode .....	3-33
3.4.2.4 Frequency tuning configuration .....	3-34
3.5 SPECTRUM ANALYSER operating mode .....	3-38
3.5.1 Spectrum operating mode (SPT) .....	3-39
3.5.2 Max operating mode .....	3-41
3.5.3 Min operating mode .....	3-42
3.5.4 Spectrum analyser mode configuration .....	3-43
3.6 TILT operating mode .....	3-44
3.6.1 Tilt mode configuration .....	3-45
3.7 HUM Operating Mode .....	3-47
3.7.1 Hum Configuration mode .....	3-48
3.8 DATALOGGER operating mode .....	3-49
3.8.1 Datalogger configuration .....	3-51
<b>4 CONNECTION TO A COMPUTER</b> .....	<b>4-53</b>

5 CONTROL SOFTWARE PROMAX-12..... 5-54

    5.1 Software Installation ..... 5-54

    5.2 Starting the program ..... 5-54

    5.3 Firmware Updating ..... 5-55

    5.4 Editing a channel plan or a channel plan group ..... 5-56

    5.5 Datalogger ..... 5-58

6 SPECIFICATIONS  ..... 6-59

    6.1 Specifications PROMAX-12 ..... 6-59

7 MAINTENANCE  ..... 7-66

    7.1 Instructions for returning by mail..... 7-66

    7.2 Method of maintenance ..... 7-66

    7.3 Cleaning the cover..... 7-66

    7.4 Components which user can not replace ..... 7-67

        7.4.1 Not replaceable fuses by user ..... 7-67

ANNEX 1 OP-012-O: DVB-T (COFDM) option ..... 1

ANNEX 2 CARRIER / NOISE RATIO MEASUREMENT (C/N) ..... 4



# CABLE TV ANALYSER

## PROMAX-12

### 1 GENERAL

#### 1.1 Description

The **PROMAX-12** is a multi-functional equipment, perfect for the telecommunication installer since it integrates several functions: **Level Meter, Datalogger, Scan, Tilt, Spectrum Analyser**, measurement and type of voltage (**AC/DC**) detection, **HUM** and **Cable Digital Analyser** which makes it an excellent tool for the installation and maintenance of analogue and digital television signal reception/distribution systems working in the 5 to 1005 MHz range, which includes FM radio, community TV systems (MATV), cable TV (CATV) and wireless cable TV (MMDS) including the sub-band (return path).

The **PROMAX-12** incorporates the power level measurement function in the whole frequency band, very useful to check a possible input saturation of some broadband demodulators and optical transceivers. In addition, with the HUM function is possible to detect a modulation at low frequency that affects the carrier and produces a distinctive hum in both image and audio.

As a Level Meter, the **PROMAX-12** enables the following measurements:

► **Analogue channels:**

- Video carrier level measurement.
- Carrier / Noise ratio measurement (C/N).
- Video / Audio ratio measurement (V/A).
- Audio Carrier Power Measurement.
- CSO - CTB Intermodulation distortion measurement.
- HUM measurement.

► **Digital channels (TV and radio):**

- Channel power measurement by integration.
- Carrier / Noise ratio measurement (C/N).

► **Digital channels DVB-C, ITU J-83 (Annex A, B and C)\*:**

- Bit Error Rate (BER) measurement.
- Modulation Error Ratio (MER) measurement.
- Graphical representation of Constellation Diagram.

---

\* Also available DVB-T (COFDM) option under request.



The **Datalogger** function allows up to 55 loggers or measurements to be taken and stored, each with carrier levels, C/N and V/A ratios, channel power or MER of up to 140 channels. The measures obtained can be checked on the equipment or transferred to a PC via the mini-USB connector.

In **Scan** operating mode, the **PROMAX-12** indicates the level of all channels present on the band in a bar-graph display. The span and reference level are user definable. A moving marker shows the exact level of each specific channel.

In **Tilt** operating mode, the screen shows, both graphically and numerically, the difference in levels between any four previously defined pilot frequency channels, in order to obtain a qualitative measurement on band equalisation.

As a **Spectrum Analyser** it provides the analysis of the entire band, with a span defined by the user from 1 to 100 MHz. Furthermore, it is possible to alter the reference level, and to detect and maintain the **maximum** and **minimum** values for **INGRESS** measurements.

The **HUM** mode measures the frequency and the value (%) of the **HUM**, which is a low frequency modulation that affects carriers and produces a distinctive **hum** in both image and audio, especially in analogue signal. At the input, this function also identifies automatically the voltage type (DC or AC), the voltage and the frequency (only for AC).

In designing the **PROMAX-12**, special attention was given to building a multi-purpose, accurate, yet easy-to-use instrument. A simple keyboard gives direct access to the various operating modes and, once in them, any measurement parameter can be easily changed using the rotary selector/button.

In addition, it has a **mini-USB terminal** for connecting to a computer for producing reports on the measurements obtained.

The instrument is powered by means of an internal rechargeable battery.

All these functions have been brought together in one instrument weighing only half a kilo. The ergonomic, sturdy design makes the **PROMAX-12** a working tool without parallel.





## 2 SETTING UP

### 2.1 Package Content

Check that your package contains the following elements:

- PROMAX-12 analyser.
- F/female - F/female input adapter.
- Mains Adapter 100-240V/50-60 Hz.
- Mains cable for EUROPE and other countries.
- Carrying bag.
- Rubber holster.
- Quick reference guide.

**NOTE:** Keep the original packaging, since it is specially designed to protect the equipment. You may need it in the future to send the analyser to be calibrated.



## 2.2 Power supply

The **PROMAX-12** is a portable instrument powered by a built-in 7.4 V Li Ion rechargeable battery. Before taking any measurement, the user should make sure that the battery is fully charged.

The equipment can work powered by the battery or connected to the mains through the power adapter.

### 2.2.1 Battery charge

The instrument has a 100-240V / 50-60 Hz mains adapter, to power the instrument or to recharge the battery.

**CAUTION:** Before using the power adapter, make sure that the adapter is suitable for the mains voltage.

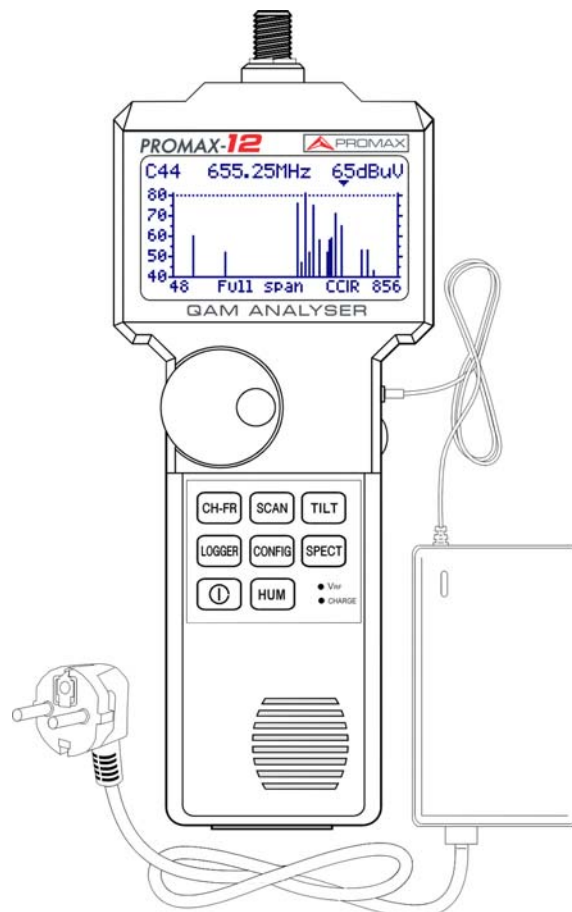

Figure 1. **PROMAX-12** connected to the power adapter.



### 2.2.2 Recommendations for using

In case of anticipating a long period of inactivity for the equipment it is recommended to store it with the battery fully charged and at temperatures below 25 °C.

It is advisable in these cases to carry out every three months a charge / discharge cycle and later a partial charge (for example, 50%).

## 2.3 Installation and start-up

The PROMAX-12 has been designed for use as a portable equipment.

An indicator on screen shows the battery level (). This indicator has 4 levels according to the charge level. A fully charged battery can power the equipment for more than six hours.

When the low battery indicator appears on the display () , the battery must be recharged.

When a fully discharged battery is installed, it is possible that, due to residual charges, the PROMAX-12 may start up. In this case, the instrument will automatically disconnect before the low battery indicator appears on the display.

### 2.3.1 Contrast adjustment

If you are holding down the key CONFIG, you will see the message "CONTRAST ADJUSTMENT - Move the Encoder" on the screen. In this situation, turning the rotary knob  is possible to adjust the contrast to get the best displaying at any environmental condition. The new contrast value remains even after you shut down the instrument.



2.4 Equipment Details

■ Front View



Figure 2.



■ Keyboard

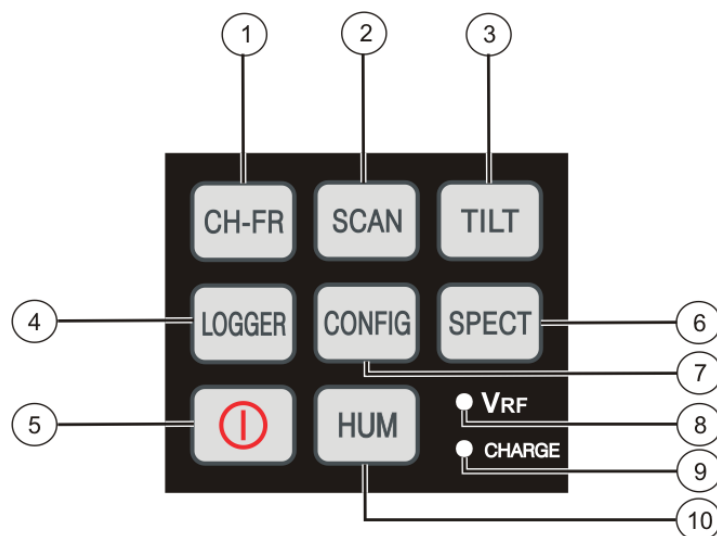









Figure 3.

- 1  Selects the **CHANNEL - FREQUENCY** operating mode.
- 2  Selects the **SCAN** operating mode.
- 3  Selects the **TILT** operating mode.
- 4  Selects the **DATALOGGER** operating mode.
- 5  On/Off key.
- 6  Selects the **SPECTRUM ANALYSER** operating mode.
- 7  Access to **CONFIGURATION** menus specific to each operating mode and to the global configuration menu of the unit.
- 8  VRF Indicator of measured voltage at the input.
- 9  CHARGE Battery charge indicator.
- 10  Selects the **HUM** operating mode.



### 3 OPERATING INSTRUCTIONS

#### 3.1 Operating instructions and Navigation

##### ► Operating Modes

The PROMAX-12 has the following independent operating modes:

##### CH-FR

It changes between frequency tuning and channel tuning. The operating mode measures the video carrier **level**, the Carrier/Noise ratio (**C/N**), the Video/Audio ratio (**V/A**) and activates audio carrier demodulation for **analogue** channels. For **digital** channels, it measures the channel power and the Carrier/Noise ratio (**C/N**), the Bit Error rate (BER) and the Modulation Error ratio (MER) and represent the Constellation Diagram. It also permits to measure the **CSO** and **CTB** intermodulation distortion.

##### LOGGER

The **LOGGER** operating mode enables multiple measurements to be performed and memorised for subsequent checking and transfer to PC. It can perform and store up to 55 loggers in the memory. Each logger carries out level, C/N, V/A, channel power or MER measurements on the channels activated in the channel plan (up to a maximum of 140 channels).

##### SCAN

The **SCAN** operating mode shows the signal level of all channels present on the chosen frequency band in a bar-graph display. The span and the reference level may be selected through the rotary selector. In addition, a moving marker shows the numeric level of any specific channel. This mode also allows the user to define the pilot channels, used for the TILT measurement (only in the forward band).

##### SPECT

The **SPECTRUM ANALYSER** mode provides a spectrum analysis over the entire band in two parts: return path or sub-band (5 to 80 MHz) and forward band (5 to 1005 MHz). The span is user definable. In addition, it is possible to change the reference level, and **maximum** and **minimum** levels may be detected and held for INGRESS measurements.

**TILT**

The **TILT** operating mode shows on the display, both graphically and numerically, the level difference between any four frequencies, previously defined as pilot channels, in order to obtain information about band equalisation. This function can be applied to the forward band and to the return path, independently.

**HUM**

This is a multifunctional key. For one hand, it measures the **HUM** frequency and value (%). HUM is a low frequency modulation that affects carriers and produces a characteristic buzzing in both image and audio, especially in analogue signals. On another hand, it automatically identifies the voltage type (DC or AC) at the input and the frequency in case of alternating voltage.

**CONFIG**

Access the **CONFIGURATION** parameters for the selected function and the global parameters for the equipment (more details in the next section).



► **Navigation**

To access any operating mode, simply press the corresponding key.

The parameters relative to a particular operating mode can be modified through the **configuration menu associated to the mode**. In order to access the configuration menu associated to a particular operating mode, simply press the key **CONFIG**. Some modes have more than one configuration page, to access to the second page it is necessary to press the **CONFIG** key again. The general parameters of configuration (selecting/editing the channel plan, measurement units, language, etc.) can be changed through the **Global Configuration Menu**, to which it is access by pressing again the **CONFIG** key. To leave a configuration menu, just press the key of the operating mode you wish to access.

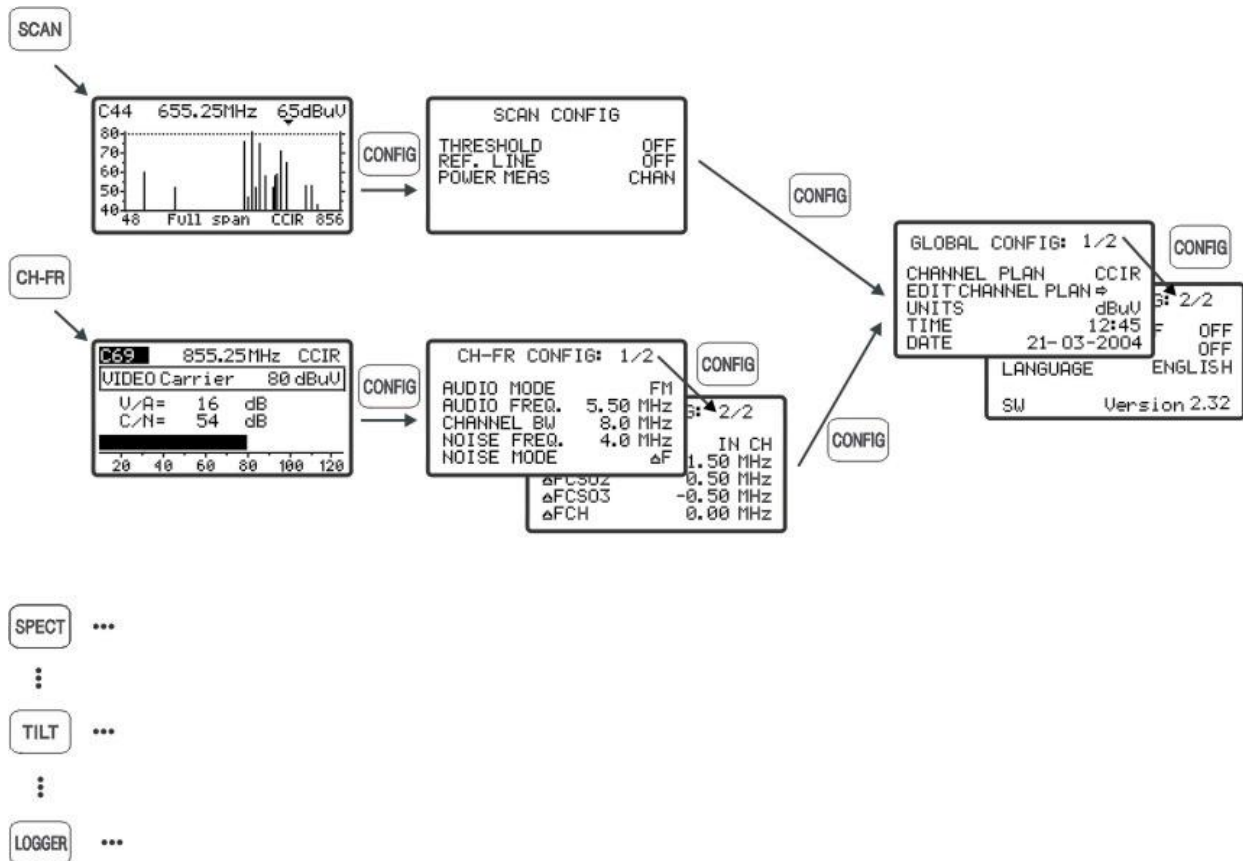



**Figure 4.** Accessing the configuration menus.





### 3.2 Global configuration menu



In order to access the global configuration menu, from any operating mode (SCAN, CH-FR, SPECT, etc.), you must press the  key repeatedly until you see at the top of the screen the headline "Global Config: 1/2". The global configuration menu consists of two pages (attached figure shows the first one), to switch from one to the other simply press the  key.



```

GLOBAL CONFIG:  1/2
CHANNEL PLAN    CCIR
EDIT CHANNEL PLAN →
UNITS           dBμV
TIME            12:45
DATE            21-07-2014
  
```

Figure 5. Global configuration. 1/2

In order to modify the state of a given parameter, you must turn the rotary selector  until this one appears shaded and next press it, then the value of the parameter will appear shaded and turning the selector a new value will be able to be defined. Finally, to validate the new state, press the rotary selector  again.

The first page of the global configuration menu permits to modify the following parameters:

▶ **CHANNEL PLAN**

It allows you to choose the active channel plan between the 10 channel plans that unit can store (CCIR, EIA, OIRT, FCC, etc...).

▶ **EDIT CHANNEL PLAN**

Refer to next section "Edit Channel Plan".

▶ **UNITS**

The equipment allows the user to select the level units among dBmV, dBμV and dBm.

▶ **TIME**

To enter the time select the **TIME** field and press the rotary selector. Firstly, turn the rotary selector to change the minutes field. Next press the selector again to modify the hours and finally press it once again to confirm the new time.



► **DATE**

To enter the date select the **DATE** field and press the rotary selector. First change the year field, then the month and finally the day.

The parameters which may be modified on the second page of the global configuration menu of the unit are as follows:

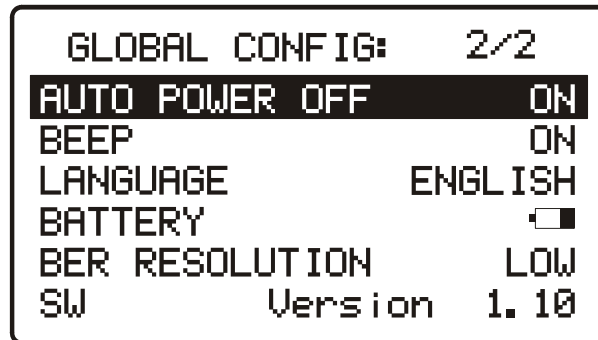

Figure 6. Global Config. 2/2.

► **AUTO POWER OFF**

This field permits to activate (ON) or deactivate (OFF) the POWER-OFF function. When this function is ON, the unit automatically turns off when it has remained inactive for a period of 10 minutes.

► **BEEP**

This function permits to activate (ON) or deactivate (OFF) the equipment beeper. When it is on, it sounds on pressing any key or when turning the rotary selector in order to alert the user.

► **LANGUAGE**

This field permits to select the language between: SPANISH, FRENCH, POLISH, ENGLISH and GERMAN.

► **BATTERY**

It indicates the battery level.

► **BER RESOLUTION**

- LOW BER measurements every 2s. The minimum measured BER for a signal at 64QAM and a SR at 6875 Ks/s is  $10^{-7}$
- HIGH BER measurements every 20 s. The minimum measured BER for a signal at 64QAM and a SR at 6875 Ks/s is  $10^{-9}$
- Continuous measurements up to 30 minutes. The minimum measured BER for a signal at 64QAM and a SR at 6875 Ks/s is  $10^{-11}$ .



The resolution selected in the configuration, applies also in the measurements done in **LOGGER** mode, with the exception of the **CONT** mode that measures time of 20 s (in **HIGH** mode).

► **SW**

The lower line of the screen shows the **version** of the unit **control software**.

**IMPORTANT:** To leave the global configuration menu, just press the key of the operating mode you wish to access.

3.2.1 **Edit Channel Plan**

When selecting this field and pressing the rotary selector, the unit access to the active **CHANNEL PLAN**.

The attached figure shows an example of channel plan. The first line shows the name of the channel plan (**CCIR** in the figure), the audio carrier offset (**5.50 MHz**), the modulation type (**FM**) and the units of measurement (**dBμV**). Next line shows the head of the columns that constitute the channel plan: the first column (**CHAN**) shows the name of each channel and the second one (**FREQ**) the associated frequency, in MHz. The third column (**BW**) defines channel bandwidth, in MHz. The fourth column (**ON**) activates or deactivates the channel and the fifth ones (**DIG**) defines if the channel is analogue or digital.

In the case of defining the channel as digital, the configuration page of parameters relative to QAM measurement will be accessed directly.

The maximum number of channels in a channel plan is 140.



CCIR	5.50	FM	dBμV	
CHAN	FREQ	BW	ON	DIG
<b>ALL</b>				
C02	50.50	7.0	<input checked="" type="checkbox"/>	<input checked="" type="checkbox"/>
C03	55.25	7.0	<input checked="" type="checkbox"/>	<input type="checkbox"/>
C04	62.25	7.0	<input checked="" type="checkbox"/>	<input type="checkbox"/>
S01	105.25	7.0	<input checked="" type="checkbox"/>	<input type="checkbox"/>
S02	112.25	7.0	<input checked="" type="checkbox"/>	<input type="checkbox"/>

Figure 7. Channel Plan Editor.

The activation (ON) / deactivation (OFF) of the channels affects to the following operation modes: **SCAN** and **LOGGER**. When a channel has been deactivated, this one will not be able to be tuned nor to be measured. This property allows to make agile the operation of the **PROMAX-12**, because it allows to activate only those channels in which we are interested.



The Edit Channel Plan function allows to automatically activate all the channels defined in the channel plan by means of the **ALL** field on the third line. When to the right of **ALL** we select **ON**, all the channels of the plan will be activated, otherwise, if we select **OFF** all channels will be deactivated. In order to activate / deactivate a particular channel, turn the rotary selector  until this one appears shaded and then press it, the cursor will jump to the ON column, then turning the selector it will be possible to activate it (it appears a cross) or to deactivate it (it does not appear a cross).

By means of the Edit Channel Plan function also it is possible to define channels as analogue or digital. To do this, turn the rotary selector  until the channel that you wish to modify appears shaded and then press it twice, the cursor will jump to the DIG column, then turning the selector it will be possible to define it as digital (appears a cross, channel C02 in the example of the previous figure) or as analogue (it does not appear a cross). In the case of selecting it as digital it is possible to access directly to the digital channel configuration. In order to return to the Edit Channel Plan function press the  key.



After editing an analogue channel, the feature  $\Delta$ FCH appears at 0.00 MHz. It is the displacement of the channel when it is tuned, for those channels that have the frequency displaced relating to the standard frequency. You can vary within a range from -2.00 to +2.00 MHz.

To modify the rest of characteristics of the channel plans it is necessary to use the **PROMAX-12** control software available in the **PROMAX** download area at the website ([www.promaxelectronics.com](http://www.promaxelectronics.com)).

To exit the Edit Channel Plan function, press any other function key.

### 3.3 **SCAN operating mode**

The **SCAN** operating mode shows, in a single screen, the signal level of all the active channels in the channel plan by means of a bar-graph. In addition, the exact level of any particular channel may be measured by simply placing the marker over it (the measurement is calibrated only for analogue channels; for digital channels refer to the note at the end of the section).

To access this mode of operation you should press the **SCAN**  key. At first, the field **channel** (C44 in the figure) will appear shaded, indicating that is selected and modifiable. Next to the channel, it appears the frequency (655.25 MHz in the figure) and the level (65 dB $\mu$ V in the figure) of the channel where the marker is pointing. The marker is moved by using the rotary knob .

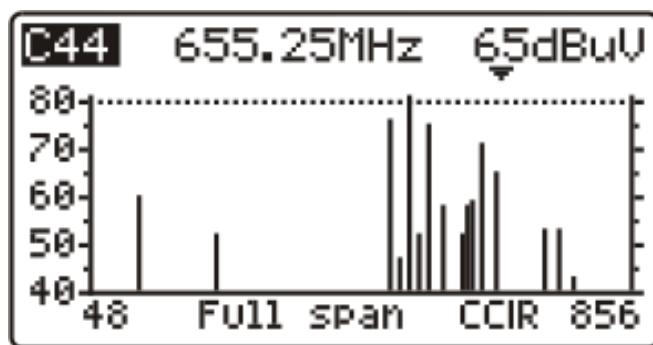



Figure 8. SCAN mode, full span.

To change the **span** (bandwidth represented on the screen), first select it by pressing the rotary knob until you see the "sp" shade (at the middle bottom of the screen). Then turn the rotary knob . If you rotate clockwise the **span** will increase and if you rotate anti-clockwise it will decrease. **Span** can acquire the following values: 10, 30, 100, 300 MHz and full span.

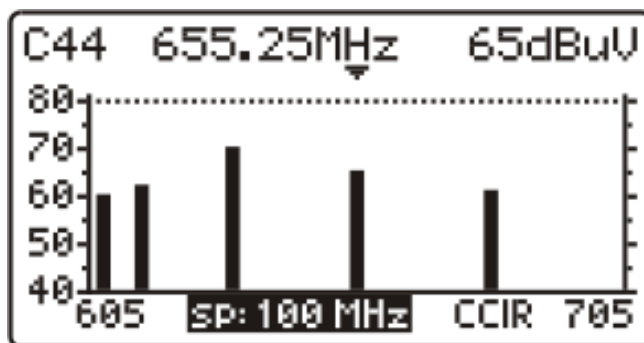



Figure 9. SCAN mode, span 100 MHz.

When pressing again on the rotary knob  the field level of **reference** will be selected. It is the maximum level of the vertical axis of the chart. By turning the rotary knob  clockwise it will increase and if you turn anti-clockwise it will decrease.

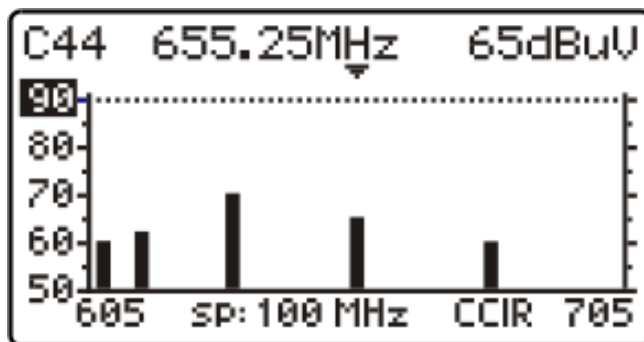



Figure 10. SCAN mode, Ref. 90 dBuV.



To change the tune, press again the rotary knob . The field Channel will be activated again. Turning the rotary knob will be possible to change its value.

The attached figure shows a horizontal line at 45 dB $\mu$ V. This line allows establishing judgements of channel level acceptance easily. To activate and define this **reference** line, you should see the SCAN configuration menu.

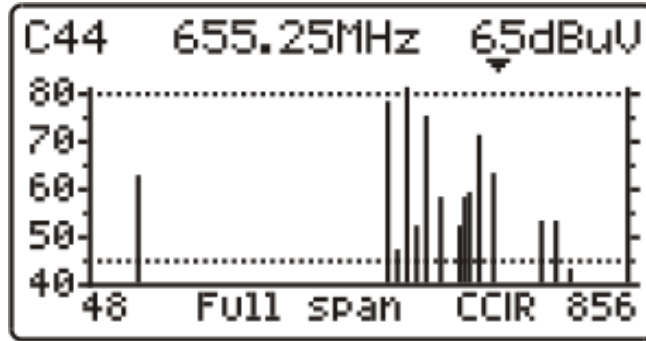

Figure 11. SCAN mode with reference line at 45 dB $\mu$ V.

In the case of having activated the broadband power detection function (**POWER MEAS** ->  $\Sigma$ PWR) in the configuration menu of **SCAN** mode, on the display of equipment will appear the total power level on the instrument RF ( $\Sigma$ PWR) input. See the attached figure.

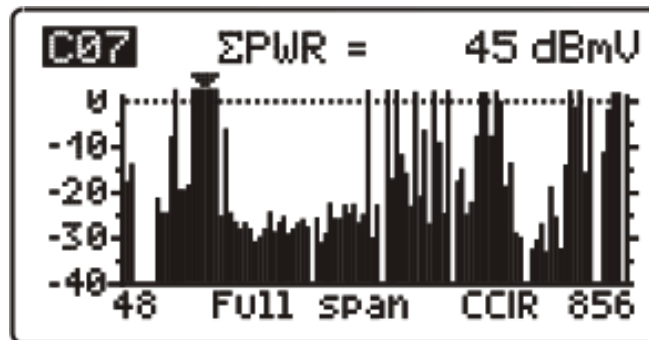

Figure 12. SCAN mode, power detection function.

This parameter indicates the total power that is being transmitted by the connected coaxial cable to the equipment in the band from 5 to 1005 MHz.

The **SCAN** operating mode also allows channels to be programmed for use as pilots in **TILT** operating mode, in the forward band (see section **TILT** operating mode).



**IMPORTANT:** In the **SCAN** operating mode, all channels are considered as analogue. When the power of a digital channel is measured in this mode, the instrument does not carry out the integration of the power values, but it just measures at the central frequency of the digital channel. Then, the resulting value is not calibrated and is 6 or 7 dB lower than the measurement made in the **CHANNEL-FREQUENCY** mode, which does the power integration

### 3.3.1 SCAN mode configuration

In the **SCAN** operating mode, pressing the **CONFIG** key  will access the configuration menu for this mode.

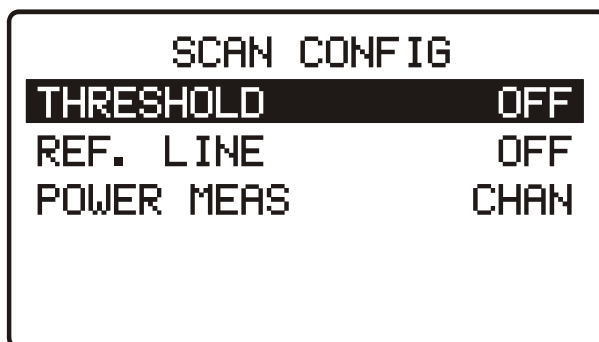

Figure 13. SCAN configuration menu.

This menu permits to change three parameters: **THRESHOLD**, **REFERENCE LINE** and **POWER MEASUREMENT**. To access to any of them, turn the rotary selector until it appears shaded and next press the selector, then the value of the parameter will appear shaded and turning the selector you will be able to modify its value. Finally, to validate the new value, press the rotary selector again.

#### ► THRESHOLD

It defines the minimum level to show channel on the display (OFF or between 21 and 120 dB $\mu$ V). If the threshold is deactivated (OFF), on the SCAN representation will appear all the active channels of the channel plan with a level higher than 20 dB $\mu$ V. Otherwise, if we define a level for the THRESHOLD parameter, channels with a level lower than the threshold value will not be displayed.

#### ► REFERENCE LINE

It permits to activate or to deactivate (OFF) a reference line on the SCAN graph (between 21 and 120 dB $\mu$ V). This reference line allows to establish judgements of channel level acceptance just with a glance at the SCAN screen.



► **POWER MEASUREMENT**

It allows to define if the measurement of the power is carried out on the channel bandwidth (**CHAN**) indicated by the MARKER or over the full band between 5 and 1005 MHz (**ΣPWR**).

**IMPORTANT:** To leave the **SCAN** operating mode configuration menu, just press the key of the operating mode you wish to access.

### 3.4 CHANNEL-FREQUENCY operating mode

The **CHANNEL-FREQUENCY** operating mode provides the following measurements

- **Analogue channels:**
  - Video carrier level.
  - Carrier / Noise (C/N) ratio.
  - Video / Audio (V/A) ratio.
  - Audio Carrier Level.
  - CSO-CTB intermodulation distortion measurement.
  
- **Digital channels:**
  - Channel power by measurements integration.
  - Carrier / Noise (C/N) ratio.
  - Bit error rate (BER).
  - Modulation error ratio (MER).
  - Constellation Diagram.

To access to this mode of operation, press the **CH-FR** key .

There are two tuning modes: by **channel** or by **frequency**. To switch between these two modes of tuning, press successively the **CH-FR** key .



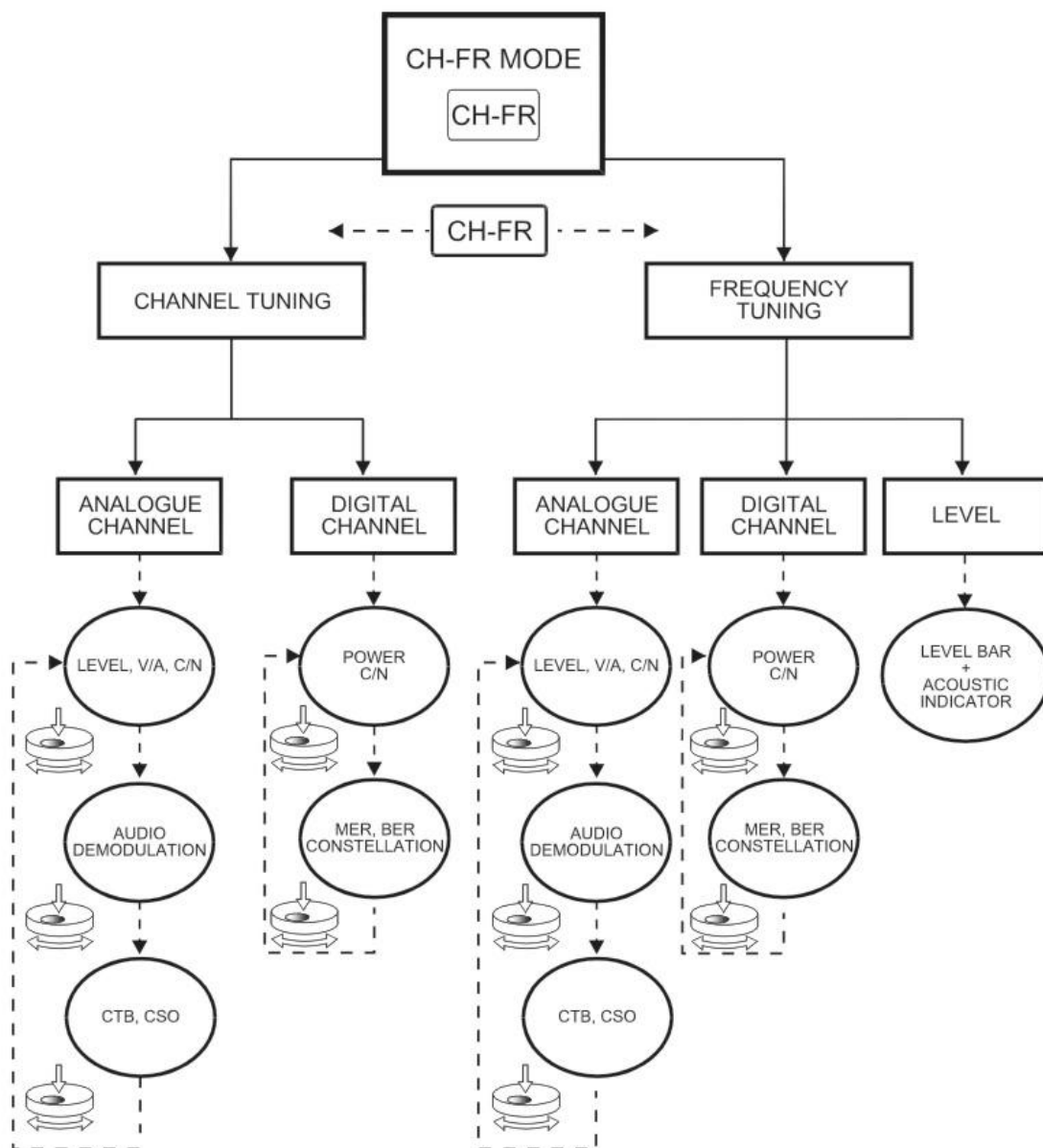

Figure 14. Access to the measurement functions, CH-FR operation mode.



### 3.4.1 Channel tuning

#### 3.4.1.1 Video carrier measurement (analogue channels)

If the tuned channel has been defined as analogue by means of the Edit Channel Plan function (see section Global Configuration Menu), the **PROMAX-12** will display a screen as the one shown in the attached figure.

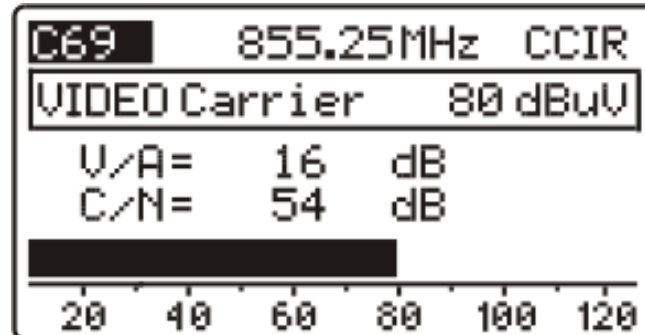



Figure 15. V/A and C/N Level measurement.

The tuned channel (C69 in the figure) appears in the higher left hand corner; this may be changed by turning the rotary selector . At its right appears the frequency (855.25 MHz) and the active channel plan (CCIR in the figure).

Below is shown the **video carrier level**, **VIDEO Carrier** (80 dB $\mu$ V in the example). The units of measurement may be changed using the Global Configuration Menu. At the bottom, a bar-graph displays the level with a resolution of 1 dB.

Also the **ratios between the video and the audio carriers (V/A)** and the **video carrier and noise (C/N)** are shown. The example in previous figure shows a channel with a Video/Audio ratio of 16 dB and a C/N ratio of 54 dB.



**3.4.1.2 Audio carrier measurement (analogue channels)**

For the PROMAX-12 to demodulate an audio signal and show its characteristics (level and frequency offset), press the rotary selector  again. In the attached figure, the audio carrier level (AUDIO Carrier) is 64 dB $\mu$ V and the frequency offset is 5.50 MHz (F). It also shows if the audio (whether Level, FM or AM) is activated (a speaker appears) or not (the speaker does not appear). To change the audio carrier offset (F) and the audio modulation (Level, FM or AM) access to the Channel-Frequency configuration menu.

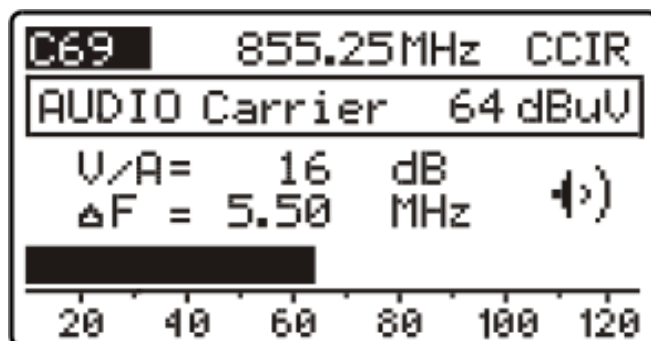

Figure 16. Audio demodulation and measurement.

**3.4.1.3 Distortion products measurement (analogue channels)**

The active devices present in the distribution systems, when working in its non-linear zone, generate interfering signals, called distortion products, that can fall within the video bandwidth. From a certain level this interference becomes visible on the TV image.

The distortion products of greater level and which usually fall within the channel bandwidth are those of second and third order beats.

The **CSO** distortion (Composite Second Order) is defined, as a ratio of the peak level of the video carrier to the peak of the distortion products of second order beat, produced by the rest of channels. The ratio is expressed in dB and can be resembled to a C/N measurement as it is desired to be maximum.

Similarly, the **CTB**, Composite Triple Beat, is defined as a ratio of the peak level of the video carrier to the peak of distortion products of third order beat, which show up at the same frequency as the video carrier.

In order to obtain these measurements, the carriers of the channel plan that is desired to transmit, must be present in the network and the measurements must be carried out for each one of the channels of the system.



Second order beats show up within the channel, around the video carrier, but as the relative position of the video carrier in all the channels can be different, it is difficult to determine where they are going to appear, as a consequence we would have to be made a sweep within all the channel. The equipment performs this measurement automatically at four frequencies around the video carrier (-1.5, -0.5, +0.5 and +1.5 MHz). These frequencies can be modified by the user (refer to the section 4.2.3.3. Channel-Frequency mode configuration menu).

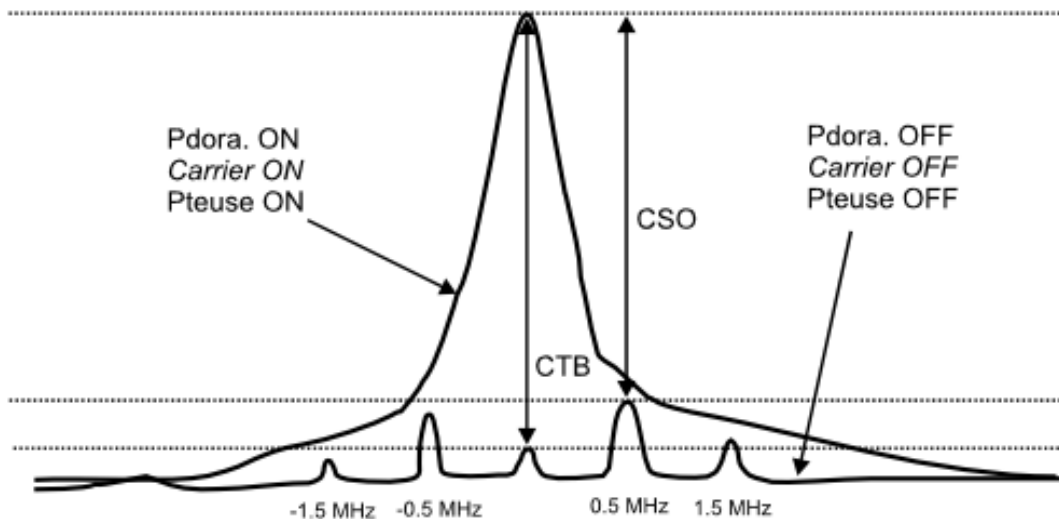



**Figure 17.** Interpretation of the CSO and CTB measures.

The equipment displays as **CSO** value the worst measurement (that is to say, the **CSO** ratio that has minor value) accompanied of the frequency offset for which it has been obtained (for example, in the figure previous at +0.5 MHz).

The **CTB** measurement is performed equivalently to the **CSO**. If all the channels that are transmitted have the video carrier at the same position within the channel, then the **CTB** beat will show up at the same frequency as the video carrier. It is for that reason, that the equipment makes this measurement at the same frequency as the video carrier and, as consequence, to make this measurement it is necessary to **turn off** the video carrier of the channel we want to analyse. If it is not possible to turn off the carrier at the head-end, the equipment allows, like approach, to make this measurement at one of the free adjacent channels (see section Channel-Frequency mode configuration).



► **MEASURING METHOD**

When pressing the rotary selector  again, we will access to the **CSO-CTB distortion products measuring screen**. First of all it will appear the message **REMOVE CARRIER. PRESS TO MEASURE**. That is to say, once the video carrier level on which it is desired to make the measurement appears on the screen, you must press the rotary selector  in order that the unit retains the carrier level and comes to calculate the CSO and CTB ratios; next you must turn off the video carrier of the channel you want to make the measurement (at the right of the CTB measurement will appear the message **Carrier OFF**).

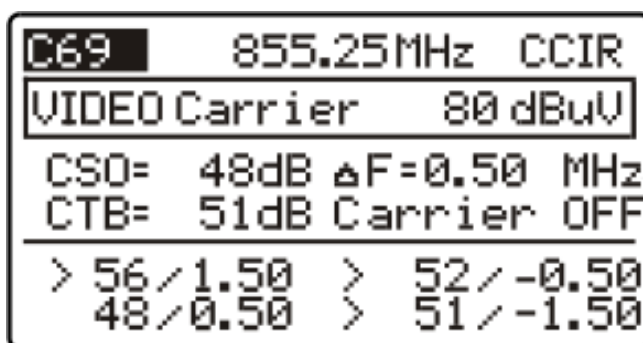



Figure 18. CSO and CTB measurement.

The display will show the level of the video carrier (80 dB $\mu$ V in the previous figure) and the **CSO** ratio accompanied by the frequency offset for which the minimum ratio has been obtained and the **CTB** ratio with the message **Carrier OFF** or **Carrier ON** according to the instrument has detected the absence or not of carrier.

At the lower part of the display it is shown the 4 measures made for the estimation of the CSO value.

If the rotary selector  is pressed again, the unit will return to the measurement screen of the video carrier + V/A +C/N.



### 3.4.1.4 Measurement of DVB-C / DVB-T / DAB (digital channels)

When the tuned channel has been defined as digital by means of the Edit Channel Plan function (see section 4.2.1 Global Configuration Menu) a screen as shown in the attached figure will appear. This screen shows the digital **CHANNEL POWER** together with its related channel bandwidth (BW) and the **Carrier/Noise ratio (C/N)**. At the bottom of the screen, as in the case of analogue channels, a bar graph represents the channel power, with a resolution of 1 dB.

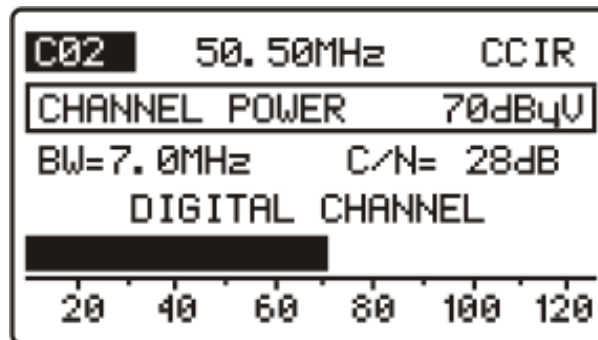

Figure 19. Measuring a digital channel.

**VERY IMPORTANT:** In order to measure digital channels correctly, previously, the channel must be defined as digital (see Edit Channel Plan function at section 'Global Configuration menu') and, if necessary, the CHANNEL BW parameter should be redefined by means of the Channel-Frequency configuration menu.

When a channel has been defined as digital, the equipment tunes it at its central frequency.



Digital channels power measurement is carried out by means of an integration method. The equipment divides the bandwidth of the channel (**CHANNEL BW**) in sections of 230 kHz (4 by each MHz approximately) and measures the contribution of each one to the total power of the channel. This way, a very exact measurement is obtained, specially in the case of degraded channels, because the channel flatness is had in consideration.

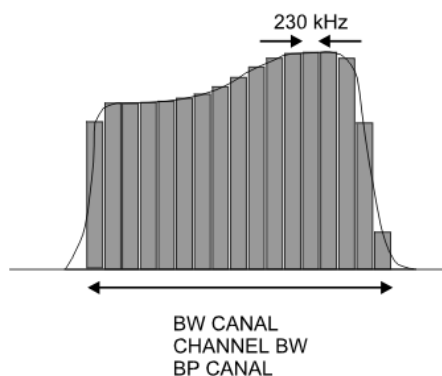

**Figure 20.** Measuring the power of a digital channel by integration.

The **C/N** ratio measurement shows the ratio between the digital channel power and the noise power. The user can define the frequency where the noise power must be measured. Two possibilities exist:

► **Absolute method**

Selecting in the Channel-Frequency configuration menu the **NOISE MODE** parameter as **FREQ**, the equipment will interpret the **NOISE FREQ.** value as the frequency where the noise power measurement must be done. Naturally the user must be sure that the **NOISE FREQ.** value corresponds with a free channel.

► **Relative method**

Selecting in the Channel-Frequency configuration menu the **NOISE MODE** parameter as  **$\Delta F$** , the unit will make the measurement of noise at the frequency obtained to add to the tuning frequency (channel central frequency) the value defined for the **NOISE FREQ.** parameter. The equipment takes by default **NOISE FREQ. =  $BW/2 + 0.5 \text{ MHz}$** , where **BW** is the channel bandwidth defined in the channel plan, thus for example, if it is desired to measure the C/N ratio of a digital channel with a bandwidth (BW) of 8 MHz, **NOISE FREQ.** will take as value 4.5 MHz. The Channel-Frequency configuration menu allows the user to redefine this parameter; when tuning a new channel the equipment will return to assign to **NOISE FREQ.** the default value.

The following figure shows that when making C/N measurements in the relative method ( **$\Delta F$** ), it is essential to bear in mind the presence of adjacent channels; otherwise, the noise could be confused with the signal of another channel.

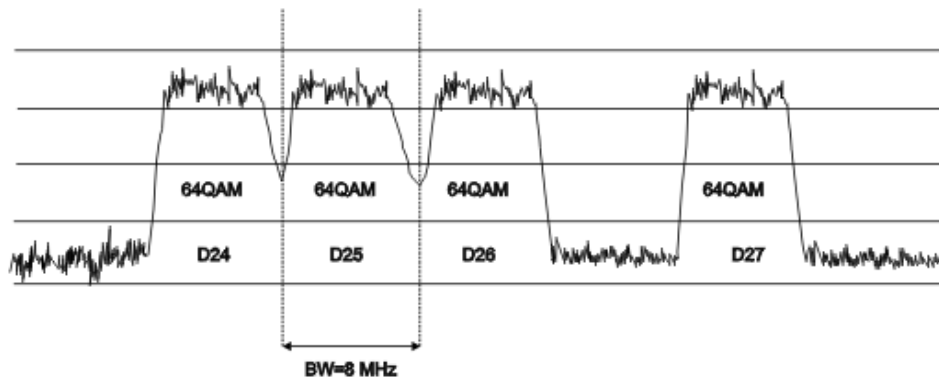



Figure 21. Example of digital channels spectrum.

Taking as example the previous figure, if we suppose that for the channels that appear in the figure it has defined a bandwidth of 8 MHz, in the relative mode of measurement the equipment will take as value for **NOISE FREQ. = 4.5 MHz**. Note that this method can cause erroneous measures in the measurement of the channels **D24** and **D25**.

For **D24** it is advised to configure **NOISE FREQ = -4.5 MHz** and to verify if the measurement increases. In case a channel has two adjacent channels (for example channel **D25**) it is recommended to select the absolute mode and to assign to the **NOISE FREQ.** parameter a frequency corresponding to a free channel (for example between **D26** and **D27**).

### 3.4.1.5 Constellation Diagram (digital channels)

Once obtained the **Power and C/N ratio measurement**, the **BER** and **MER** measurement on tuned channel as well as the **Constellation Diagram** graph representation for the **DVB-QAM** digital signal can be obtained pressing the rotary selector .

The equipment, after some seconds for calculation, will show a screen like the one of the attached figure. On it besides the Constellation diagram, also appears the type of **QAM** modulation, the symbol rate (SR), the error rate obtained for the digital signal (**Post-BER** measurement (**BER** after FEC) shown as **BER ▶**; **Pre-BER** measurement (**BER** before FEC) shown as **▶BER**), the modulation error ratio measurement (**MER**), the represented quadrants and the type of detected codification.





When pressing again the rotary selector , the equipment carries out a new measurement. If the selector rotary is pressed twice, you will access the screen of **Power** and **C/N ratio measurement** again.

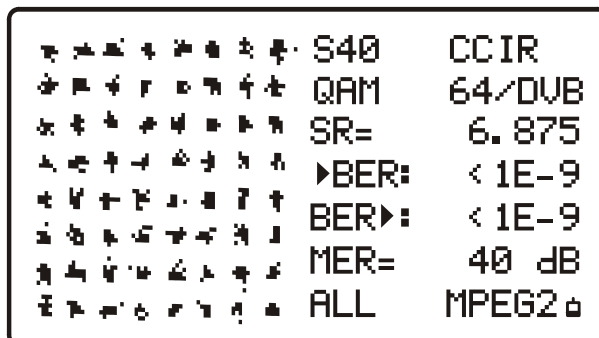
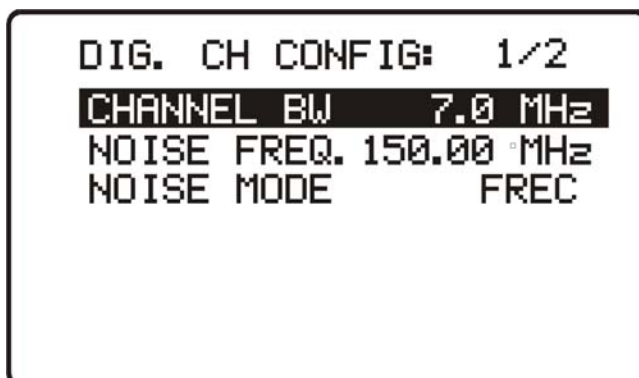

**Figure 22.** Constellation Diagram representation and Pre-BER, Post-BER and MER measurement in a digital channel.

3.4.1.6

**Channel tuning configuration**

In **CHANNEL-FREQUENCY** mode, when the instrument works in **channel** tuning, if you press the **CONFIG** key  you will access the first page of the configuration menu of the parameters relating on this mode (Fig.23).



**Figure 23.** Digital Channel Configuration. 1/2.

The parameters which may be changed and their values range are shown in the following table. The parameters are different depending on the channel, whether it is digital or analogue.

To define a **CHANNEL** as **DIGITAL** or **ANALOGUE**, you should go to the **EDIT CHANNEL** option that is in the **GLOBAL CONFIGURATION** menu.



To access the second page of the **GLOBAL CONFIGURATION** screen, press again the **CONFIG** key  (Fig. 24).

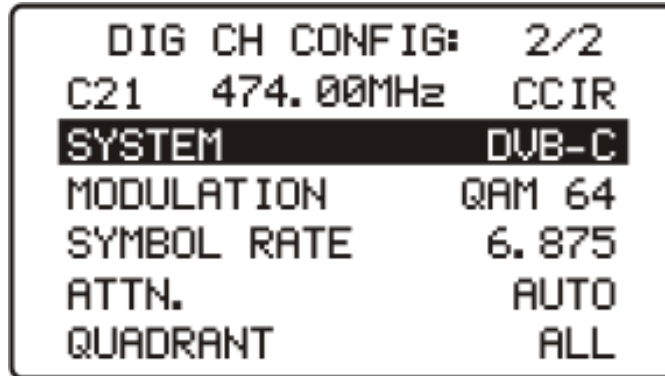



Figure 24. Digital Channel Configuration 2/2.

To change a parameter value, turn the rotary selector  until the field is activated (it will appear shaded) and then press the rotary selector, the value of the parameter will be activated and you will be able to change it by turning the rotary selector. When the value you want appears, press the rotary selector  to validate it.

Numeric fields such as **FREQ. AUDIO**, are edited digit by digit, starting from the lowest weight digit.

**CONFIGURATION** parameters of **ANALOGUE CHANNELS** in **CHANNEL TUNING** mode.

DESCRIPTION	PARAMETERS	VALUES
Audio Modulation	<b>AUDIO MODE</b>	FM: Audio FM AM: Audio AM LV: The loudspeaker emits a tone whose frequency varies according to the received signal level. OFF: Audio deactivation.
Audio carrier offset	<b>AUDIO FREQ.</b>	From 4.00 to 9.00 MHz
CTB Measurement mode	<b>CTB SHOWED</b>	<b>IN CH</b> or free channel
ΔF CS01	<b>ΔFCS01</b>	± 2,50 MHz
ΔF CS02	<b>ΔFCS02</b>	± 2,50 MHz
ΔF CS03	<b>ΔFCS03</b>	± 2,50 MHz
ΔF CS04	<b>ΔFCS04</b>	± 2,50 MHz



**CONFIGURATION** parameters of **DIGITAL CHANNELS** in **CHANNEL TUNING** mode

DESCRIPTION	PARAMETER	VALUES
Digital channel bandwidth	<b>CHANNEL BW</b>	From 0.3 to 9.9 MHz.
Frequency where noise is measured in the C/N measurement.	<b>NOISE FREQ.</b>	± 99.9 MHz (relative mode). 5.00 MHz to 863.00 MHz (absolute mode).
Noise measuring mode.	<b>NOISE MODE</b>	<b>FREQ</b> (Absolute): Noise level is measured at the frequency defined by <b>NOISE FREQ.</b> <b>ΔF</b> (Relative): The value defined by <b>NOISE FREQ.</b> is added to the tuning frequency. <b>BW/2</b> (Relative): It is measured at a frequency defined as half the bandwidth.
System (according to country)	<b>SYSTEM</b>	DVB-C, ITU J83-B, ITU J83-C, DVB-T*
QAM Modulation	<b>MODULATION</b>	16, 32, 64, 128, 256
Symbol Rate	<b>SYMBOL RATE</b>	1,000 to 7,000
Constellation Quadrant View	<b>QUADRANT</b>	Q1, Q2, Q3, Q4, Q1+, Q2+, Q3+, Q4+, ALL

The **CTB SHOWED** parameter allows defining the method of measurement for the CTB. **"IN CH"** (within the channel) is the suitable method whenever the carrier of the channel in study can be turned off. If it is not possible, as approach, any other channel (free) can be defined for the measurement of the CTB.

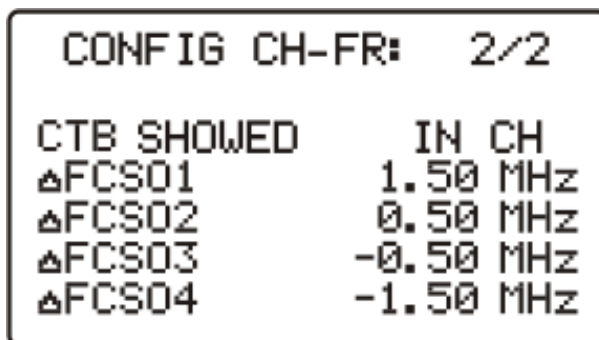

**Figure 25.** CH-FR Configuration 2/2.

Parameters  $\Delta FCS01$ ,  $\Delta FCS02$ ,  $\Delta FCS03$  and  $\Delta FCS04$  allow you to modify the frequencies where the CSO is measured (the equipment admits values from -0.5 to -2.50 and from 0.5 to 2.5 MHz). These parameters are modified digit to digit, beginning by the one of smaller weight.

\*DVB-T (COFDM) option available under request.



**IMPORTANT:** To exit the CHANNEL-FREQUENCY CONFIGURATION menu, press the mode of operation to which you want to access.

### 3.4.2 Frequency Tuning

Pressing the **CH-FR**  key you can switch between tuning by channel or tuning by frequency and vice versa.

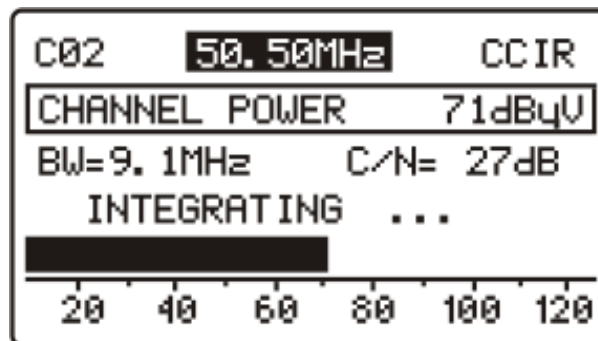



Figure 26. Frequency tuning.

To verify you are working on the Frequency Tuning mode, check what field is shaded:

- If the channel is shaded, then you are working in **Channel Tuning Mode**.
- If the frequency is shaded, then you are working in **Frequency Tuning Mode**.

In the frequency tuning mode, the instrument becomes a receiver with a resolution of 10 kHz within the band from 5 to 1005 MHz. In this mode you can tune any signal within this band, including leakage pilots or telephone and communications signals.

To change frequency, turn the rotary knob . User can change the frequency step in the Configuration menu (refer to "Frequency tuning configuration"). The channel name appears at the left of the tuning frequency, as long as it corresponds to an active channel.



There are three modes of frequency tuning measurements:

- Level Mode.
- Analogue Mode.
- Digital Mode.

You can change the measurement mode from the Configuration menu (see section "Frequency Tuning Configuration").

#### 3.4.2.1 Level Mode

In the level Mode it appears a screen where the level of the input signal is represented by a bar graph and by a numeric value.

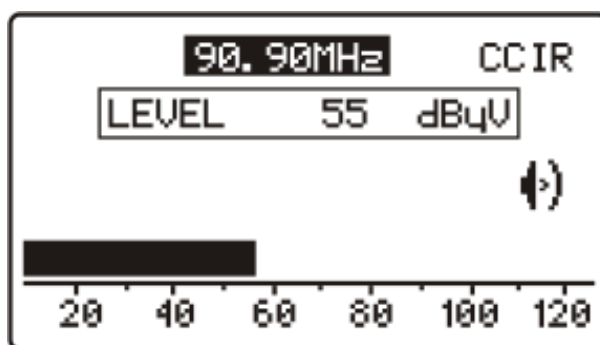



Figure 27.

The signal also can be audible through the loudspeakers, depending on the option selected on the Configuration menu.

#### 3.4.2.2 Analogue Mode

In the Analogue Mode can be taken three types of measures. Press the rotary knob  to switch among them. These measurements are:

- ▶ Video Carrier Measurement.

It shows the power level of the video carrier at the frequency tuned. It is represented by a bar graph and in numeric value.



It also shows the V/A ratio and the C/N ratio in dB.

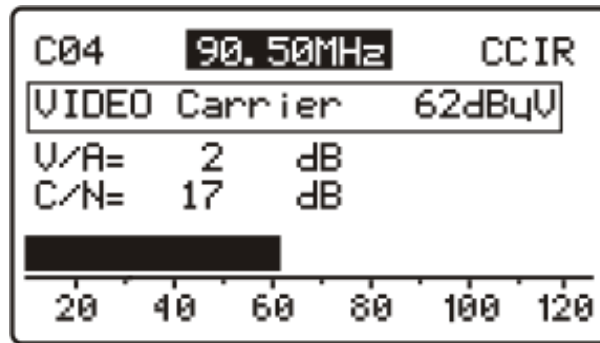

Figure 28.

► Audio Carrier Measurement.

It shows the power level of the audio carrier at the frequency tuned. It is represented by a bar graph and in numeric value.

It also measures the V/A ratio and the offset between the audio signal and the video signal.

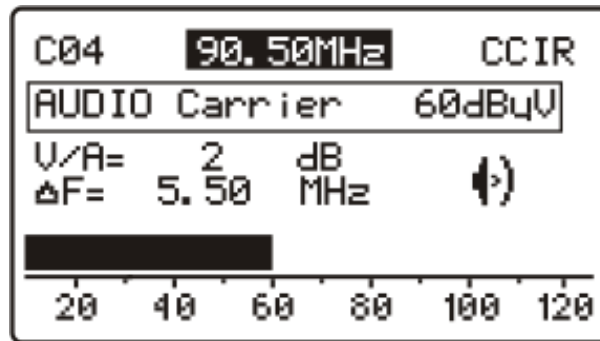

Figure 29.



- ▶ CSO-CTB intermodulation measurement.

On the screen appears: the level of the video carrier, the CSO measure, the deviation of the frequency from which has been obtained the minimum ratio, the CTB measure and whether the Carrier is OFF or ON.

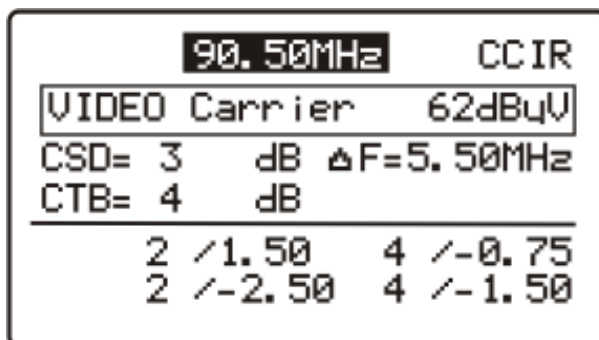

Figure 30.

### 3.4.2.3

#### Digital Mode

In this mode, you can make two types of measurements. To switch between them, you must press the rotary knob one or two times. The measurements are:

- ▶ **Input Channel Power**

The digital mode shows the power level of the input channel. It is represented by a bar graph and in numeric value. It also measures the C/N ratio (carrier / noise).

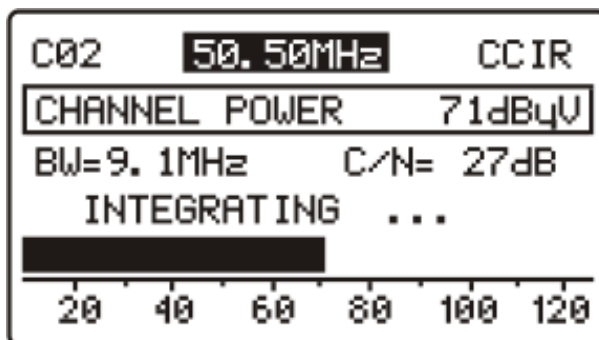

Figure 31.



To switch to Constellation Diagram press once the rotary knob.

► **Constellation Diagram**

In this mode is shown the Constellation Diagram and other related measures (see figure).

- QAM modulation type.
- Encoding type detected.
- Symbol rate (SR).
- Error rate obtained for the Post-BER digital signal (BER after FEC) indicated by BER ▶
- Error rate obtained for the Pre-BER digital signal (BER before FEC) indicated by ▶BER.
- Error rate of modulation (MER).
- Quadrant shown.
- Locked / Unlocked.

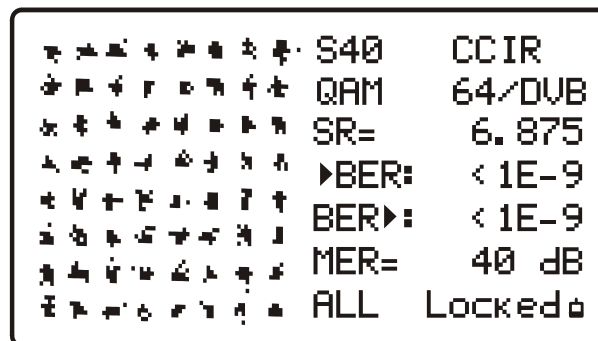



Figure 32.

To measure again, just press again on the rotary knob .

To switch to the **Input Channel Power**, press fast and twice the rotary knob



### 3.4.2.4 Frequency tuning configuration

From the **FREQUENCY TUNING** mode, press the key  **CONFIG** and then it will appear the Configuration menu related to the frequency tuning.





Depending on the type of measurement, the Configuration menu changes. There are three types of measurements in frequency tuning: **ANALOGUE**, **DIGITAL** and **LEVEL**. Each one can be selected from the **FREQ. MODE** option on the **CONFIGURATION** menu.

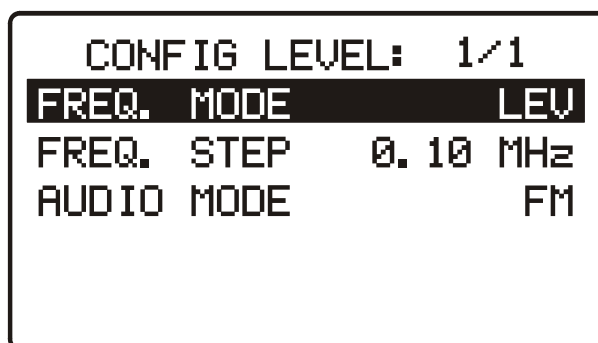

Figure 33. Config Level.

The options available on the Configuration menu in the **LEVEL** measurement mode are next:

- ▶ **Freq. Mode:** It allows you to change the measurement signal among **ANL** (Analogue), **DIG** (digital) and **LEV** (Power Level).
- ▶ **Freq. Step:** It allows you to change the step of frequency. This is put into practice when you are using the rotary knob to change frequency .
- ▶ **Audio Mode:** There are four options to receive the audio signal: **LEVEL**, **AM**, **FM**, **OFF**.
  - In **LEVEL** mode, the instrument beeps depending on the power input.
  - In **AM** mode, you can listen to AM (Amplitude Modulation) radio signals.
  - In **FM** mode, you can listen to FM (Frequency Modulation) radio signals.
  - In **OFF** mode, the loudspeakers are off.



Figure 34. AN. FR CONFIG: 1/2.

The options available on the Configuration menu in the **ANALOGUE** measurement mode are next:

- ▶ **Freq. Mode:** It allows you to change the measurement signal among **ANL** (Analogue), **DIG** (digital) and **LEV** (Power Level).
- ▶ **Freq. Step:** It allows you to change the step of frequency. This is put into practice when you are using the rotary knob to change frequency.
- ▶ **Audio Mode:** There are four options to receive the audio signal: **LEVEL**, **AM**, **FM**, **OFF**.
  - In **LEVEL** mode, the instrument beeps depending on the power input.
  - In **AM** mode, you can listen to AM (Amplitude Modulation) radio signals.
  - In **FM** mode, you can listen to FM (Frequency Modulation) radio signals.
  - In **OFF** mode, the loudspeakers are off.



Press **CONFIG**  again to the next page 2/2.

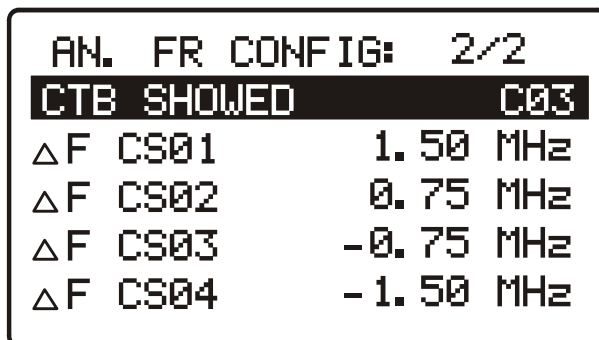

Figure 35. Analogue Configuration Screen 2/2.

- ▶ **CTB Showed:** The **CTB SHOWED** parameter allows defining the method of measurement for the **CTB. IN CH** (within the channel) is the suitable method whenever the carrier of the channel in study can be turned off. If it is not possible, as approach, any other channel (free) can be defined for the measurement of the **CTB**. Parameters **ΔFCS01**, **ΔFCS02**, **ΔFCS03** and **ΔFCS04** allow modifying the frequencies where the CSO is measured (the equipment admits values from -2.50 MHz to 2.5 MHz).

The options available on the Configuration menu in the **DIGITAL** measurement mode are next:

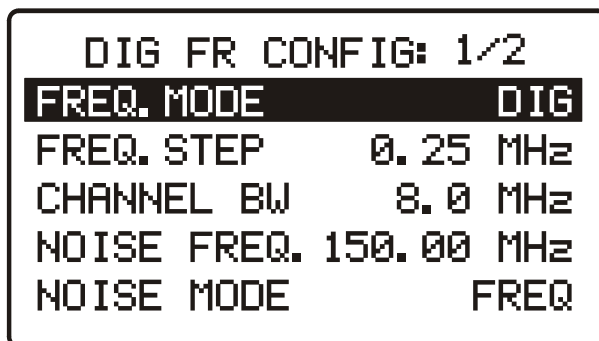



Figure 36. Digital Configuration Screen 1/2.

- ▶ **Freq. Mode:** It allows you to change the measurement signal among ANL (Analogue), DIG (digital) and LEV (Power Level).
- ▶ **Freq. Step:** It allows you to change the step of frequency. This is put into practice when you are using the rotary knob to change frequency.
- ▶ **Channel BW:** It allows you to change the channel bandwidth.
- ▶ **Noise Freq.:** It allows you to change the noise frequency.



- ▶ **Noise mode:** In this mode there are three options: **AF** (frequency offset), **BW/2** (half the bandwidth), **FREQ** (noise frequency).

Press **CONFIG**  again to the next page 2/2.

DIG. FR CONFIG: 2/2	
<b>SYSTEM</b>	<b>DVB-C</b>
MODULATION	QAM 64
SYMBOL RATE	6.875
ATTN.	AUTO
QUADRANT	ALL

Figure 37. Digital frequency configuration 2/2.

- ▶ **System:** Compression system used. Possible values are DVB-C, ITU J83-B or ITU J83-C (also available DVB-T (COFDM) option under request).
- ▶ **Modulation:** It is the modulation used. Selectable values are QPSK, QAM 16, QAM 32, QAM 64, QAM 128 and QAM 256.
- ▶ **Symbol Rate:** It is the rate of symbols sent. The range is from 1000 to 7000.
- ▶ **Attenuation:** User can select attenuation between auto or manual (values between 0 and 60 dB in 10 dB steps).
- ▶ **Quadrant:** To select what constellation quadrant you want to view: ALL, Q1, Q2, Q3, Q4, Q1+, Q2+, Q3+, Q4+.

**NOTE:** When switching from frequency to channel, if the tuned frequency does not correspond to any channel, the equipment will search for the channel nearest to this frequency and will stay tuned to this channel. This operation may take a few moments.

### 3.5 **SPECTRUM ANALYSER operating mode**

Pressing the  key the unit switches to the SPECTRUM ANALYSER mode. This function has 3 different operating modes (SPT, MAX and MIN), which are selectable through the spectrum mode configuration menu.



### 3.5.1 Spectrum operating mode (SPT)

In the **SPECTRUM** mode, the equipment provides a spectral analysis of the band; the span and the reference level are variable. The spectral analysis can be done in the **forward band** or in the **return path** as it is selected in the spectrum configuration menu; this menu also allows to select the **detector** used for the representation of the spectrum between **peak** and **average**.

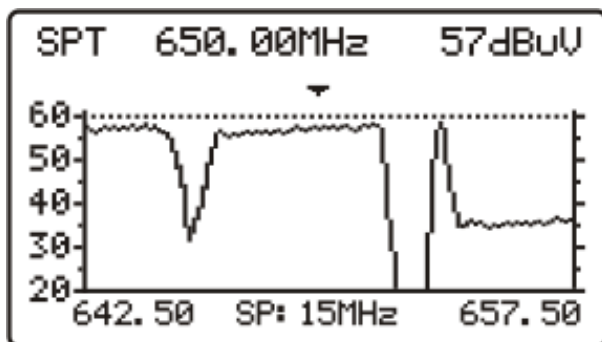



Figure 38. SPECTRUM mode.

The marker frequency is displayed in the higher left hand corner of the screen and, to its right, the frequency signal level. To alter the marker frequency turn the rotary selector .

By pressing the rotary selector  you can alter the span between 1, 5, 15, 100 MHz and full span (5-1005 MHz).

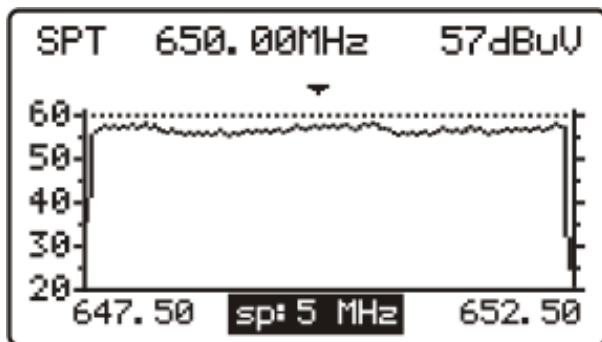



Figure 39. SPECT mode, span reduction.



By pressing the rotary selector  again the reference level may be modified.

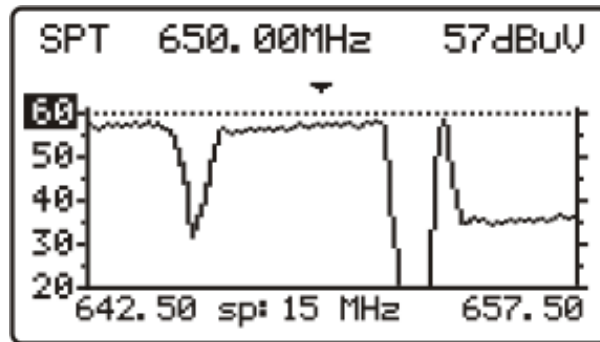



Figure 40. Reference level setting.

Pressing the rotary selector  a second time will activate the tuning frequency field of the marker, being possible to tune new frequencies.

The attached figure shows an horizontal line at 45 dB $\mu$ V. This line allows to identify levels over a reference of our interest easily. The activation and definition of this **reference line** is carried out on the spectrum analyser configuration menu.

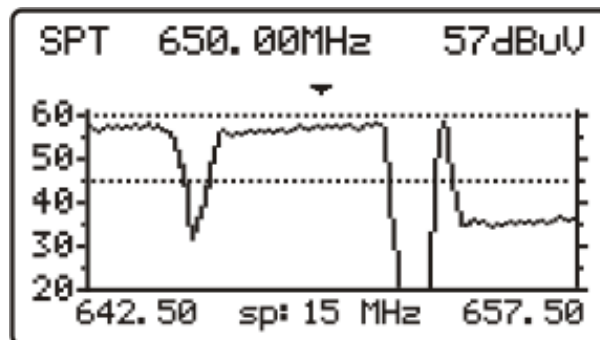

Figure 41. Reference line.



### 3.5.2 Max operating mode

The SPECTRUM operating mode also permits to be configured as **maximum hold** (MAXIMUM INGRESS). This option is selected on the Spectrum Configuration menu. In the **MAX** mode, the equipment holds on the screen the maximum measured level through a dotted line.

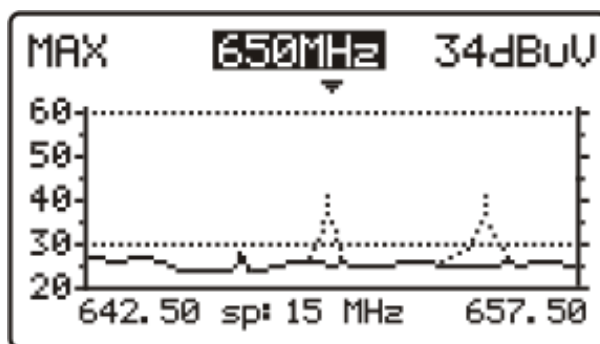

Figure 42. MAX mode.

This measurement is used to be carried out on the return path and permits to detect intermittent interferences.

Since on this operation mode the equipment holds on the screen the maximum measured value (through a dotted line), after making several measurements over the band, it will be possible to detect impulsive type interferences. It is advised to previously define a reference line which actuates as a maximum noise threshold.



### 3.5.3 Min operating mode

This measurement permits to detect permanent channel interferences that in an other way could remain masked because of the variable nature of the signal. It is interesting in analogue channel measurements as well as in digital channel.

To select this representation mode you must select the **MIN** mode, MINIMUM INGRESS (see section Spectrum mode configuration menu).

In this operating mode it is advised to select the Average detector (see section Spectrum mode configuration menu).

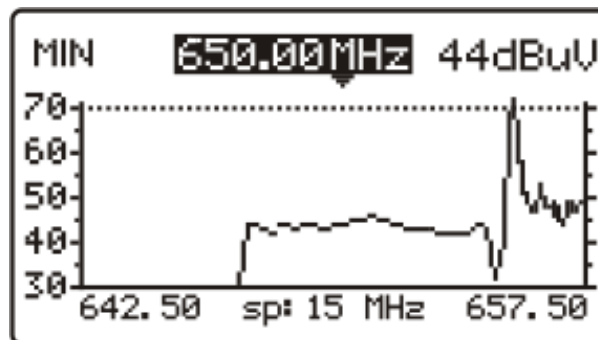

Figure 43. MIN mode. First scan.

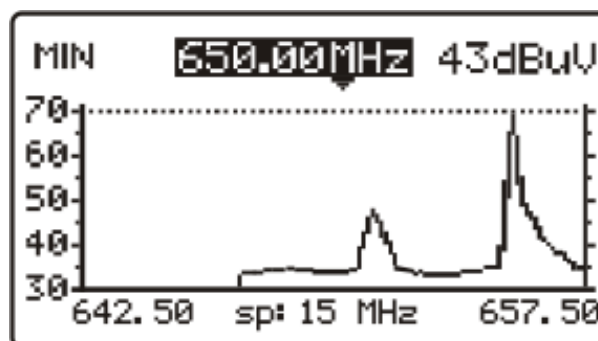



Figure 44. After several scans.

Previous figures show an example of this measurement over a digital channel. Left figure corresponds to the first sweep. After several sweeps (right figure) an interference is seen at the centre of the channel, which previously remain masked by the noisy nature of the signal.





### 3.5.4 Spectrum analyser mode configuration

Pressing the **CONFIG** key  will access the parameter configuration menu for the **SPECTRUM** function.

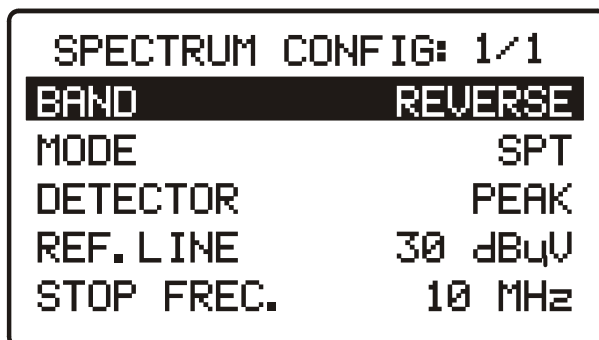



Figure 45. SPECT mode configuration.

To change the value assigned to one parameter, turn the rotary selector  until its field is activated (this will appear shadowed) and then press. The value of the parameter will be activated and may be changed by turning the rotary selector. When the value you want appears, press the rotary selector  to validate it.

The parameters that can be modified through this menu are:

► **BAND**

It selects the analyzed band between:

- **RETURN PATH** Sub-band spectrum (5 to 80 MHz).
- **FORWARD** Band from 5 to 1005 MHz.

► **MODE**

It selects the representation mode:

- **SPT** Instantaneous value.
- **MIN** Minimum values held (MIN INGRESS).
- **MAX** Maximum values held (MAX INGRESS).

► **DETECTOR (only for SPT, MAX and MIN modes)**

It selects the type of detector between:

- **PEAK**
- **AVERAGE**



► **REF. LINE**



It permits to activate / deactivate and to define the reference line level in 1 dB steps from 20 to 120 dB $\mu$ V (dB $\mu$ V units). This line appears on the spectrum representation.

**IMPORTANT:** To leave the configuration menu of the SPT mode, just press the key of the operating mode you wish to access.

### 3.6 TILT operating mode

The **TILT** operating mode displays on-screen, graphically and numerically, the difference in level between any four frequencies previously defined as pilots. This function provides a quantitative measurement about band equalisation.

This function can be applied to forward and to the return paths, according to is defined in the TILT mode configuration menu (section Tilt mode configuration).

To access this mode of operation press the **TILT** key . The screen will show a bar-graph of the four pilot channels and the difference in level (TILT) between the upper pilot and the lower pilot (- 5 dB in the example). When the pilots are not present or its level is lower than 20 dB $\mu$ V, the message '**NO PILOTS**' will appear. Turning the rotary selector  the reference level may be modified.

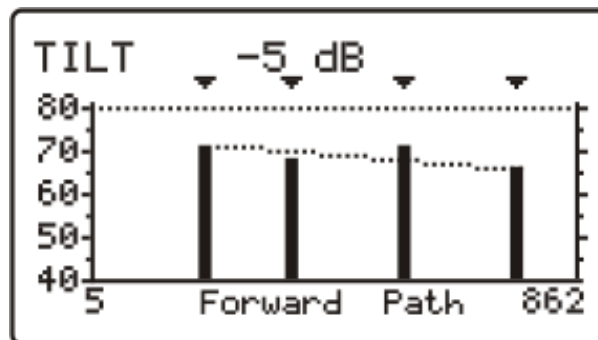

Figure 46. TILT mode.





The pilots may be defined in two ways:

► **By frequency**

Using the TILT configuration menu. See section "TILT mode configuration".

► **By channel (only pilots in the forward band).**

From the **SCAN** mode. In order to do this:

- 1 Place the marker over the channel you want as low pilot
- 2 Press the **SCAN** key , and the message 'PILOT 1: PRESS TILT' will appear at the bottom of the screen.
- 3 Keeping the **SCAN** key  held down, press the **TILT** key , and a message 'PILOT 1 ENTERED' will appear as confirmation.

Repeat the steps 1 to 3 for the 3 following pilots.

3.6.1 **Tilt mode configuration**

Pressing the **CONFIG**  key will access to the first page of the configuration menu.

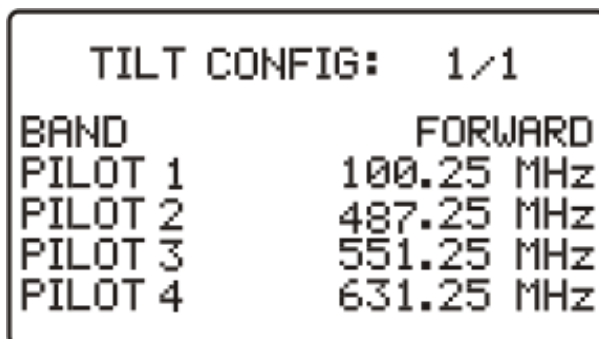



Figure 47. TILT configuration (FORWARD mode).



To change a given parameter turn the rotary selector  until the field is activated (this will appear shadowed) and then press. The value of the parameter will be activated and may be changed by turning the rotary selector. When the value you want appears, press the rotary selector  to validate it.

► **BAND**

It permits to select between the **FORWARD** mode (5 to 1005 MHz) and the **REVERSE** mode (5 to 80 MHz). When selecting one of these modes, the user can define the associated frequency.

► **PILOT 1**

It defines a frequency belonging to the forward or the reverse band where the first measurement of level will be done. This parameter, and the rest of pilots, is defined digit by digit, by pressing repeatedly and turning the rotary selector



► **PILOT 2**

It defines the second pilot frequency belonging to the forward or reverse band.

► **PILOT 3**

It defines the third pilot frequency belonging to the forward or reverse band

► **PILOT 4**

It defines the fourth pilot frequency belonging to the forward or reverse band.

TILT CONFIG: 1/1	
BAND	REVERSE
PILOT 1	5.00 MHz
PILOT 2	16.00 MHz
PILOT 3	27.00 MHz
PILOT 4	45.00 MHz

Figure 48. TILT configuration (REVERSE mode).

**IMPORTANT:** To leave the configuration menu of the TILT mode, just press the key of the operating mode you wish to access.



### 3.7 HUM Operating Mode

The **HUM** operating mode measures the **HUM** value (%). This feature also identifies automatically the type of voltage (DC or AC) at the input, the voltage and the frequency for alternating voltage.

The **HUM** is buzz at low frequency modulation that affects the carrier, producing a distinctive hum in both image and audio, especially in analogue signals.

To access this mode press the **HUM** key.

The display shows the power level, voltage and voltage type (AC ~ or DC —) , frequency for alternating and the **HUM** percentage.

The **HUM** value up to 2% is considered acceptable. Above this value is not acceptable and it should take appropriate countermeasures.

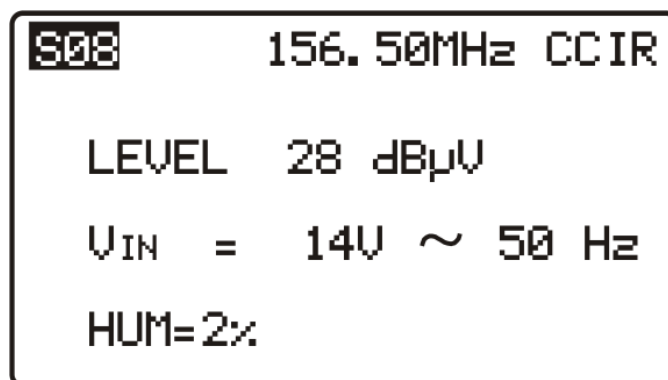



Figure 49. HUM operating mode.

Pressing the rotary knob user can change the tuning by frequency or channel. By turning the rotary knob the channel or frequency changes.



### 3.7.1 Hum Configuration mode

In the **HUM** mode, when pressing the **CONFIG** key , it gives access to the first page of the configuration menu with the parameters related to this mode.



**Figure 50.** HUM Configuration.

To access the different configurable parameters just turn the rotary knob and once the field you want to change appears shaded, press the rotary knob; then turning it, it will be possible to change its value. Finally press it again to validate the new value.

The parameters shown are:

► **Mode of Operation**

It allows the user to select the carrier to detect HUM. It may be the audio carrier, the main carrier or the digital signal. By default is selected the audio carrier.

**IMPORTANT:** To exit the HUM configuration menu press any mode key.



### 3.8 **DATALOGGER operating mode**

The **LOGGER** function permits to automatically measure the level, the Carrier/Noise ratio and the Video/Audio ratio (the latter only in the case of analogue channels) as well as the power channel and MER measurements of each active channel in the channel plan (see paragraph Channel Plan editor at section Unit Global Configuration). These measurements are stored in the memory so that they can be subsequently viewed or transferred to a PC. The equipment will store up to 55 obtained channels or loggers in the memory, with a maximum of up to 140 analysed channels in each.

When pressing the **LOGGER**  key, a screen similar to the one of the attached figure will appear. The first line shows the logger number followed by the date it was acquired (only if **MEASURE** function was executed on that logger previously). Below, the different functions you can perform from this operating mode are shown: **VIEW** and **MEASURE**.

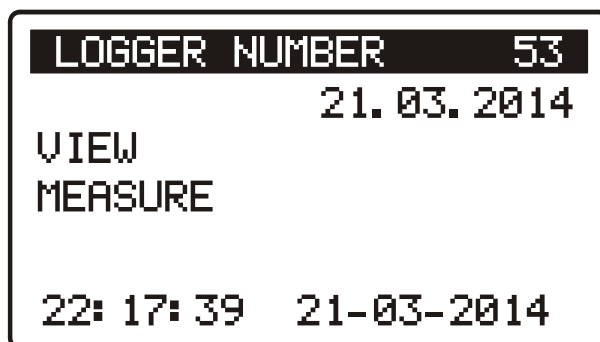





Figure 51. LOGGER main configuration screen.

On the bottom of the display appears present time and date. To modify them see section Global Configuration Menu.

To access to any of the different fields of the initial screen of the **LOGGER** function, turn the rotary selector  until it is activated (it appears shadowed) and next press it.

First of all you must select the logger on which you want to perform any function: turn the rotary selector until the **LOGGER NUMBER** field is shadowed and press it. Then turning the rotary selector, select the desired logger (from 0 to 54) and finally press it again to validate. The acquisition date appears under the logger number (only if you have taken measurements on this logger).



To carry out a logger acquisition you must select the **MEASURE** function, for this purpose turn the rotary selector  and when this field appears shadowed press it, in this way you will access to the logger. Next press again the rotary selector  in order that the equipment makes all the measurements defined in the **LOGGER** configuration menu over all the active channels of the channel plan (see Edit Channel Plan function at section "Global configuration menu").

**IMPORTANT:** The processing of channels as analogue or digital and the parameters to make the measures (the frequency of the audio carrier for the analogue channels and the frequency offset for the noise measure of the digital channels C/N ratio) will correspond with the configuration of the equipment at the time of carrying out the measurement.

To return to the initial menu of the **LOGGER** function press the **LOGGER** key



To check the measurements stored in a specific logger select the **VIEW** option:

```

17:45:02      13-04-2014
CCIR 5.50 FM dBuV
LIS:53  V      V/A  C/N
C03    21      0   <  0
C04    21      0   <  0
S01    46     28    15
S02    < 20
S03    D 42     MER = 21
    
```

Figure 52. Logger view.

The first line shows the channel plan (CCIR in the example), the audio carrier offset (5.50 MHz), the audio demodulation (FM) and the units of measurement (dB $\mu$ V). The second line shows the logger number (53 in the attached figure) and the headings of the measurements (V, V/A and C/N). The measurements taken are shown in the following format: first column shows the channel, the D indication on its right means it has been defined as digital (see Edit Channel Plan function at section "Global configuration menu"), the second column shows the level (analogue channels) or the channel power (digital channels), the third the V/A ratio (analogue channels) and the fourth the C/N ratio (analogue channels) or MER (digital channels). Turning the rotary selector  you can see the rest of channels.





The time and date when measurements were taken appear at the end of the list of measurements, in the following order: hour:minute:second and month:day:year. To return to the initial menu of the LOGGER function press **LOGGER** key.

**3.8.1 Datalogger configuration**

From the LOGGER mode, when pressing the **CONFIG** key  we will access to the configuration menu. This menu permits to modify the **THRESHOLD** and **MEASURES** parameters. To access to them turn the rotary selector and once the parameter we want to change is appears shadowed, press it; then turning it its value will be modified. Finally press it again to validate the new value.

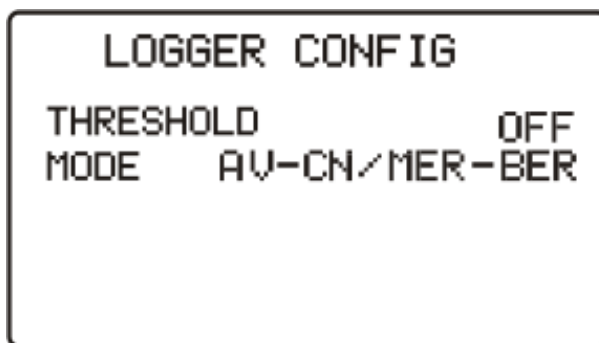

Figure 53. Logger configuration.

► **THRESHOLD: It activates / deactivates the measurement threshold.**

This parameter allows to carry out the logger function in an agile way, by activating only those measures we consider significative. In the **OFF** mode (deactivated) all measurements are taken with a level higher than 20 dBµV. On the other hand, when a level is defined, only those channels with a level higher than the **THRESHOLD** value will be measured.

► **MEASURES: It defines the types of measurements to be made.**

This parameter allows to select the measurements that are desired to made between:

	ANALOGUE CHANNELS			DIGITAL CHANNELS		
	Level	Audio / Video Ratio	Carrier / Noise Ratio	Power	MER	BER
<b>LEVEL / POWER</b>	Yes	-	-	Yes	-	-
<b>AV-CN / MER</b>	Yes	Yes	Yes	Yes	Yes	-
<b>AV-CN / MER-BER</b>	Yes	Yes	Yes	Yes	Yes	Yes (*)

(\*) **Note:** The BER measurements represent an increase of the data acquisition time.



**IMPORTANT:** To leave the configuration menu of the DATALOGGER mode, just press the key of the operating mode you wish to access.



## 4 CONNECTION TO A COMPUTER

The equipment allows the connection to a PC for data transfer, by means of a mini-USB (male) to USB (female) connection cable.

The **PROMAX-12** control software permits to carry out from a computer the following options:

▶ **CHANNELS PLAN**

**EDITOR:** Modify, add or delete channel plans.

▶ **CONFIGURATION:** Permits to modify all the configuration parameters.

▶ **DATALOGGER:** Permits to edit and to save all the measurement contained in a logger.

▶ **DATE:** Allows to update the equipment software version.

The **PROMAX-12** software control is available in the download area at the PROMAX website:

<http://www.promax.es/ing/downloads/software-and-firmware>

For more details about **PROMAX-12** software, check the next chapter.



## 5 CONTROL SOFTWARE PROMAX-12

### 5.1 Software Installation

If you do not have the file installation, download it from the PROMAX website download area at: (<http://www.promax.es/ing/downloads/software-and-firmware>). Please, before installing the program read the following instructions. In case of doubt, contact with our technical service.

- 1 Access the folder where the file is saved.
- 2 Double-click the file "Setup.exe".
- 3 The software installer opens automatically. Follow the onscreen instructions to install the software.
- 4 By default the program creates a folder at the address: C:\Program Files\PROMAX\PROMAX-12 software, where all the files are installed. It also creates a shortcut on the desktop to open the program.
- 5 In order to run the program, double-click the shortcut icon .

### 5.2 Starting the program

- 1 Turn on your PROMAX instrument.
- 2 Connect your PROMAX instrument to a USB port in your computer. Use a communication cable (mini-USB male to USB-A male).
- 3 Run the program by double-clicking the icon  on the desktop.



**When connecting to the PC it is recommended to connect it also to the mains to avoid interrupting software communication due to low battery.**

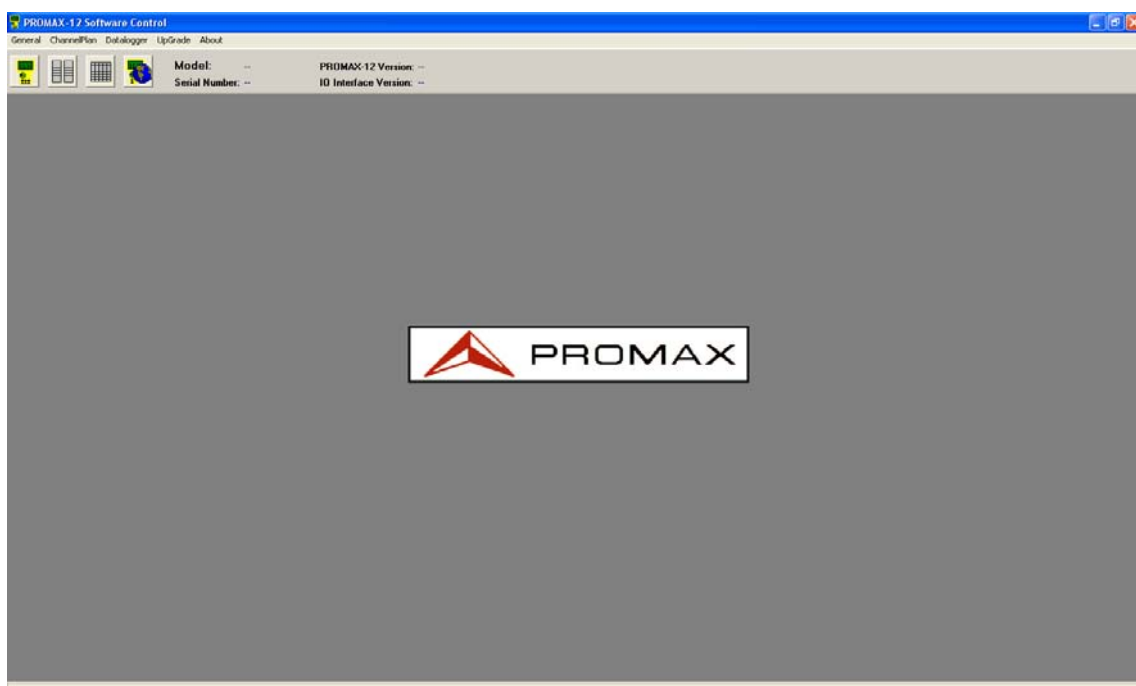



Figure 54.

- 4 In the resulting window, double-click the icon  which is in the top left hand. By this way it establishes communication between your instrument and computer.
- 5 Your computer scans its ports looking for the one connected to your instrument and then, it finds out what model is.
- 6 If during scanning it detects your instrument, the program displays a message on the screen, with information about the model and the port used. If does not detect it, it will show an error message.
- 7 Once connected, you can work with the most common functions: **Update, Edit or view Loggers.**
- 8 When finished, disconnect the USB cable from the equipment before turning it off.

### 5.3 Firmware Updating

- 1 Download the upgrade file to your computer.
- 2 Click the menu option "Upgrade \ Add Upgrade File". It opens an explorer window. Look for and select the downloaded upgrade file and click the button Open. The file will be copied into the upgrade folder.



- 3 Click the upgrade icon  at the top of the main window. It opens a new window where you should select the upgrade file from a list. Then click on the Upgrade button.
- 4 If your instrument is properly upgraded, the program shows a message box to confirm it. If there is any failure during the process, it displays a warning message.

### 5.4 Editing a channel plan or a channel plan group

- 1 Click on the icon . From the resulting window you can create and edit channel plans or groups (a group of plans is a file with various channel plans). On the right box you can see a list of channel plans. The left box shows plans that make up a group of plans.

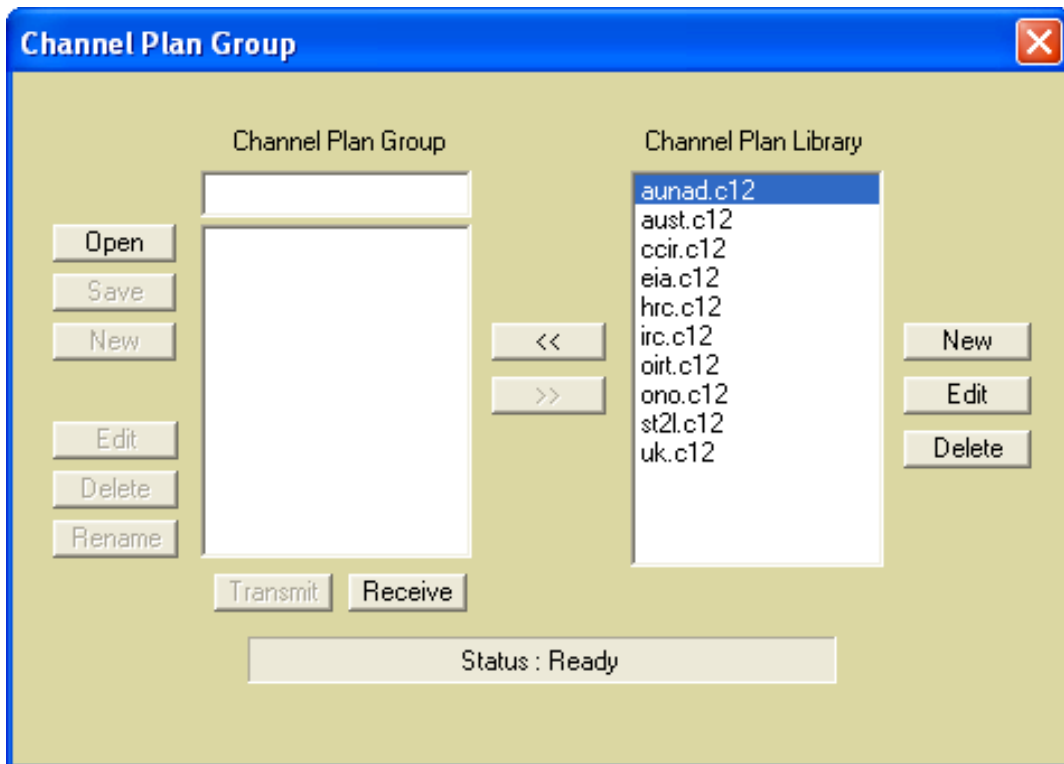

Figure 55.

- 2 To edit a channel plan, double-click one of them (right box) or select it and press Edit. A new window opens and displays all channels making up the plan. Double-click a parameter to change it. In addition to change parameters, you can also add new channels or delete existing ones. To do it, just go to "Position" box and select the position where you want to insert a new channel or delete it and then click on "Insert" or "Delete". After finishing edition, save changes.

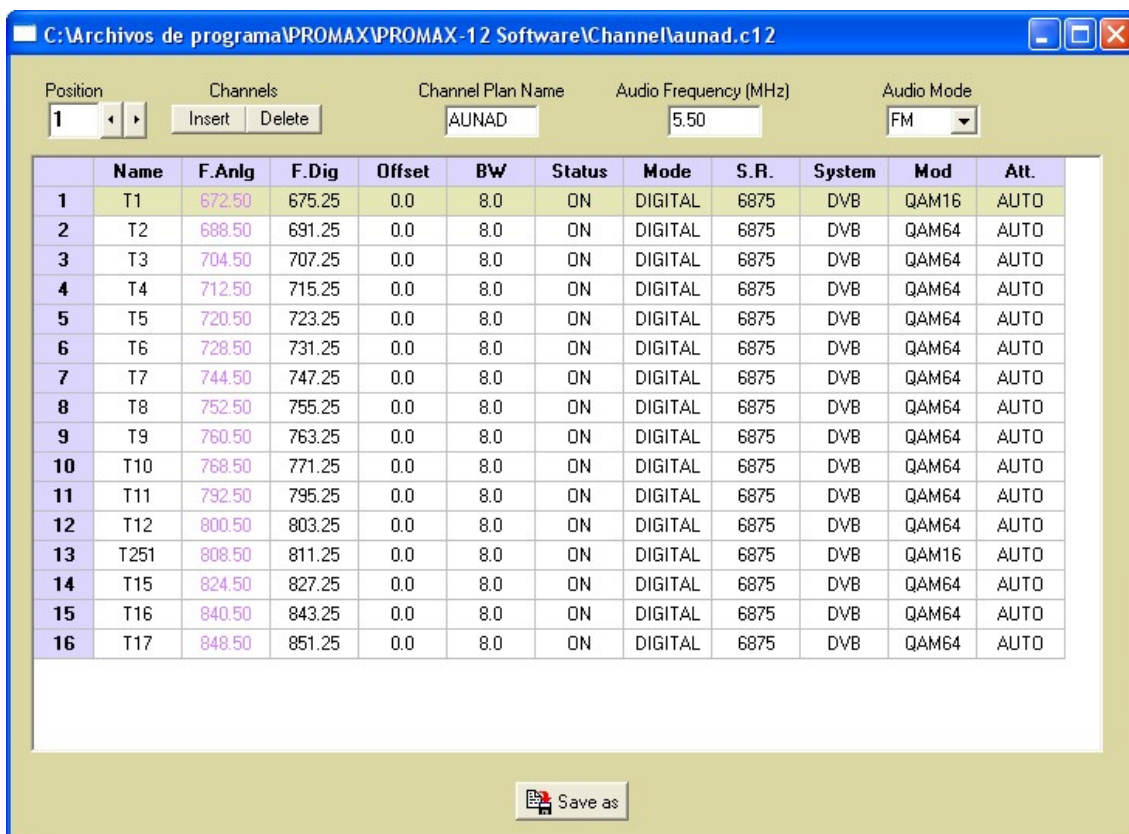



Figure 56.

- 3 To create a new group of channel plans, use the arrows placed between the two boxes, in order to pass plan files to the group box (right box) or vice versa. Eventually, when you have all plans you want for your group, assign a name for the group on the top box and save it.
- 4 To transfer a plan group file to your instrument, press the button Transmit. At the instrument memory, the new group overwrites on the old one (previously it appears a warning message). To download channel files from your instrument to your computer press Receive. Other buttons allows you Open a group file, create a New one and finally, Delete or Rename any channel plan.

**Note:** When transmitting a new plan group to your instrument, it disappears all instruments' loggers associated with the previous plan group.



## 5.5 Datalogger

- 1 Click the icon . It opens the **Datalogger** window.

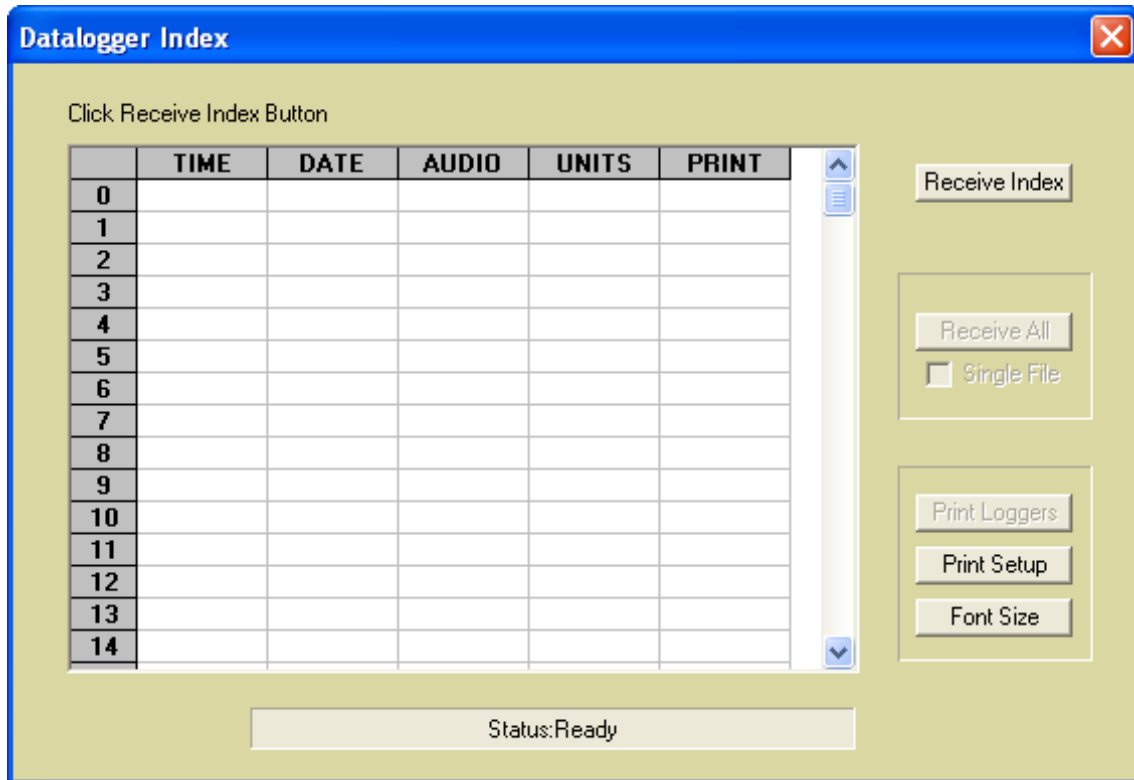

Figure 57.

- 2 To receive an index with all existing loggers in your instrument, you should click the button "**Receive Index**". Once the index is downloaded, you can see all loggers in a list on the screen.
- 3 Double-click the logger you want to see. At this time it downloads the logger selected from the instrument to the computer and you will be able to see it. To print it, press "**Print**".
- 4 If you want to download **ALL** the loggers of your instrument, click the button "**Receive All**".
- 5 In order to set up your printer, click on "**Print Setup**". In order to print one or more loggers, click on the column "Print" until "Y" (Yes) at the logger's row you want to print. Then click on the "Print Loggers" to print the selected loggers.





## 6 SPECIFICATIONS

### 6.1 Specifications PROMAX-12

#### TUNING

<b>Tuning range</b>	From 5 to 1005 MHz.
<b>Tuning mode</b>	By channels or by frequency.
<b>Channel plan</b>	10 channel plans, each one with a maximum of 140 channels. Factory start-up channel plans: CCIR, EIA, OIRT, HRC, IRC, UK, AUNA, ST2L, AUST <sup>(1)</sup> , ONO.
<b>Resolution</b>	10 kHz.
<b>Indication</b>	Graphic LCD with back lighting.
<b>Channel frequency offset</b>	± 2 MHz (10 kHz resolution).

#### POWER LEVEL MEASUREMENT (Full Band)

<b>Measuring range</b>	From 70 to 120 dBμV (From 10 dBmV to 60 dBmV <sup>(2)</sup> ).
<b>Bandwidth</b>	From 5 to 1005 MHz.
<b>Resolution</b>	1 dB.
<b>Accuracy</b>	± 3 dB (From 5 to 40 °C).

#### LEVEL MEASUREMENT

##### Measurement

<b>Analogue channels</b>	Video carrier level measurement.
<b>Digital channels</b>	Power measurement in the channel bandwidth by integration method.

##### Measuring range

<b>Analogue channels</b>	From 25 to 120 dBμV (From -35 dBmV to 60 dBmV <sup>(2)</sup> ).
<b>Digital channels</b>	From 35 to 120 dBμV (From -25 dBmV to 60 dBmV <sup>(2)</sup> ) (channels of 8 MHz).

##### Maximum input level

<b>From 5 to 1005 MHz</b>	120 dBμV (60 dBmV <sup>(2)</sup> ).
<b>DC to 60 Hz</b>	60 V DC or RMS.

<sup>1</sup> Under request carried out at the factory. (See option OP-010-61)

<sup>2</sup> Because of safety reasons, the maximum input power over the entire band is limited up to 120 dBμV. The equivalent power level for a group of channels of similar levels is related with the input power level over the entire band according to the following expression:

$$LT = L + 10 \log N$$

(LT: total level, L: mean level of one channel, N: number of channels present).

For higher input power levels, the use of an external attenuator of 20 dB is recommended.

There may be certain frequencies where the symbol "<" appears at levels higher than 25 dBμV (maximum 28 dB).

This is due to the automatic correction of the frequency response.

The value measured remains correct, although the accuracy becomes ±3 dB

**Reduction of the measurement range depending on the number of channels.**

Up to 10 channels	110 dB $\mu$ V.
From 11 to 20 channels	107 dB $\mu$ V.
From 21 to 50 channels	103 dB $\mu$ V.
From 51 to 80 channels	101 dB $\mu$ V.

<b>Readout</b>	Digital in dB $\mu$ V, dBmV or dBm and analogue through a graphic bar. 1 dB resolution.
<b>IF bandwidth</b>	200 kHz $\pm$ 30kHz.
<b>Input impedance</b>	75 $\Omega$ .
<b>Audible indicator</b>	Tone which varies with the signal level.
<b>Accuracy</b>	
<b>Analogue channels</b>	$\pm$ 2 dB (from 0 to 40 °C) for negative video modulation <sup>(3)</sup> .
<b>Digital channels</b>	$\pm$ 3 dB (from 0 to 40 °C) for 8 MHz bandwidth channels

**DIGITAL SIGNALS MEASUREMENT**
**MER (Modulation error ratio)**

<b>Measurement range</b>	22 dB to 40 dB (For channel power > 60 dB $\mu$ V).
<b>Accuracy</b>	$\pm$ 2 dB.

**BER (Bit error rate)**
**Measured before RS decoding (PreBER)**

<b>Measurement range</b>	10 E-2 to 10 E-8 (low resolution) E-9 (high resolution), E-10 in continuous mode.
--------------------------	---

**Measured after RS decoding (PostBER)**

<b>Measurement range</b>	10 E-2 a 10 E-8 (low resolution) E-9 (high resolution), E-10 in continuous mode.
--------------------------	--

**Constellation Diagram** DVB-QAM signals (Annex A/B/C) and DOCSIS / Euro-DOCSIS.

**Lock range** From 50 dB $\mu$ V to 120 dB $\mu$ V (From -10 dBmV to 60 dBmV).

**Symbol rate**

<b>Measurement range</b>	1000 to 7000 ksym/s.
--------------------------	----------------------

**Datalogger** For each digital channel, the level and the MER can be stored. (BER to transfer to PC)

**Modulation type** 16/32/64/128/256 QAM ITU J1 annex A/C, 64/256 QAM ITU J1 annex B and COFDM DVB-T under request.

**Bandwidth** 1-8 MHz

**Frequency tuner** 62.5 kHz.

<sup>3</sup> For the positive video modulation (L standard) it can vary from 0 to -2 dB among white and black image.



### VIDEO / AUDIO RATIO MEASUREMENT (ANALOGUE CHANNELS)

<b>Measurement</b>	Ratio of video to audio carrier levels.
<b>Measurement range</b>	From 0 to 40 dB.
<b>Audio subcarrier frequency</b>	
<b>Variable</b>	4-9 MHz.
<b>Accuracy</b>	± 3 dB (5-1005 MHz).

### CARRIER / NOISE RATIO MEASUREMENT

<b>Measurement</b>	
<b>Analogue channels</b>	Ratio between carrier level and the channel's noise level.
<b>Digital channels</b>	Ratio between the channel power and the noise level. The frequency where noise is measured is user definable in absolute or relative value. In the relative mode, the unit takes as default frequency offset the value BW/2 + 0.5 MHz.
<b>Measurement range <sup>(4)</sup></b>	
<b>Analogue channels</b>	40-50 dB for input level between 60 and 70 dBµV. > 50 dB for input level > 70 dBµV.
<b>Digital channels</b>	> 30 dB for input level > 60 dBµV.
<b>Accuracy</b>	3 dB (5 - 1005 MHz)

### CSO & CTB INTERMODULATION PRODUCTS MEASUREMENT

<b>CSO</b>	Ratio of the peak level of the video carrier to the peak of the distortion products of second order beat. Measured at four frequencies user definable.
<b>Measuring frequencies</b>	User definable from -2.50 to 2.50 MHz. (Default values -1.50, -0.50, 0.50 and 1.50 MHz).
<b>CTB</b>	Ratio of the peak level of the video carrier to the peak of the distortion products of third order beat. Measured at the carrier frequency or, approximately mode, in a channel previously defined by the user.

### DATALOGGER FUNCTION

<b>Max. number of loggers</b>	55.
<b>Number of channels/logger</b>	140.
<b>Measurements</b>	
<b>Analogue channels</b>	Level, C/N and V/A.
<b>Digital channels</b>	Channel power and MER. (BER to transfer to PC).

---

<sup>4</sup> See annex 2

**SCAN**

<b>Span</b>	Variable: 10, 30, 100, 300 MHz and full band (from 5 to 1005 MHz, according to the channel plan).
<b>Reference level</b>	Variable from 60 to 120 dB $\mu$ V in 10 dB steps.

**TILT**

<b>Indication</b>	Numerical and by level bar.
<b>Analysed band</b>	Forward (5 to 1005 MHz) or Return path (5 to 80 MHz).
<b>Number of pilots</b>	4 per band.
<b>Pilots frequency</b>	From 5 to 1005 MHz.
<b>Pilots resolution</b>	10 kHz.

**SPECTRUM ANALYSER**

<b>Span</b>	From 1 to 1005 MHz (1, 5, 15, 100 MHz, full span).
<b>Reference level</b>	Variable from 60 to 120 dB $\mu$ V in 10 dB steps.
<b>Analysed band</b>	Forward (5 to 1005 MHz) or Return path (5 to 80 MHz).
<b>Detector</b>	Peak or average.
<b>Bandwidth</b>	200 kHz.
<b>Resolution</b>	
<b>Peak detector</b>	
<b>Full Span (5-1005 MHz)</b>	9 MHz.
<b>Span 100 MHz</b>	900 kHz.
<b>Span 15 MHz</b>	140 kHz.
<b>Span 5 MHz</b>	50 kHz.
<b>Span 1 MHz</b>	10 kHz.
<b>Average detector</b>	
<b>Span 15 MHz</b>	140 kHz.
<b>Span 5 MHz</b>	50 kHz.
<b>Span 1 MHz</b>	10 kHz.



## HUM

<b>HUM value</b>	from 2 % to 10 %
<b>Accuracy</b>	± 1%.

## VOLTMETER

**Alternating / Direct voltage automatic detection**

**Measurement range**

<b>Voltage</b>	8 - 90 V Alternate 8 - 30 V Direct
<b>Accuracy</b>	±2 %
<b>Alternating frequency</b>	10 Hz - 200 kHz
<b>Accuracy</b>	±2 %

## AUDIO

<b>Demodulation</b>	AM / FM / LEVEL (variable tone according to the signal level).
<b>Output</b>	Internal speaker.

## POWER SUPPLY

<b>Li-Ion Battery</b>	7,4 V – 2,2 Ah.
<b>Battery Indication</b>	4 charge levels on screen.
<b>Low battery indication</b>	Graphic indication on the display: 
<b>Autonomy</b>	Approximately 6 hours (excepting measurements of MER / BER).
<b>Automatic power-off</b>	Power-off after 10 minutes of non-use (aprox.).
<b>Battery charge</b>	By fast internal charger.
<b>Equipment consumption</b>	12 W.
<b>Mains to charger adapter</b>	AL-101B 100 V a 240 V AC / 50-60 Hz / 12 V DC.

## ENVIRONMENTAL CONDITIONS

This equipment could be used on the following environmental conditions, in these conditions the specifications could also be applied:

<b>Altitude</b>	Up to 2000 metres.
<b>Temperature range</b>	From 5 °C to 40 °C.
<b>Maximum relative humidity</b>	80 % (up to 31 °C), decreasing lineally up to 50% at 40°C.

**NOTE:** Equipment specifications are set in these environmental operating conditions. Operation outside these specifications are also possible. Please check with us if you have specific requirements.



## MECHANICAL FEATURES

<b>Dimensions</b>	70 (90 on the display) W x 218 H x 50 D mm.
<b>Weight</b>	825 g (including battery and holster).

## RECOMMENDATIONS ABOUT THE PACKING

It is recommended to keep all the packing material in order to return the equipment, if necessary, to the Technical Service.

## ACCESSORIES

<b>AD-057</b>	F/female - F/female input adapter.
<b>AL-101B</b>	Mains Adapter 100-240V/50-60 Hz.
<b>CA-05</b>	Mains cable for EUROPE and other countries.
<b>DC-275</b>	Carrying bag.
<b>DC-284</b>	Rubber holster.
<b>0 DG0132</b>	Quick reference guide.

## OPTIONS

<b>OP-010-61</b>	Change channel plan. (Carried out under request in the factory).
<b>OP-012-0</b>	DVB-T (COFDM) option.

## OPTIONAL ACCESSORIES

<b>AA-012</b>	Car cigarette lighter adapter cable.
<b>AD-055</b>	F/female - BNC/female adapter.
<b>AD-056</b>	F/female - IEC/female adapter.
<b>AT-20C</b>	20 dB attenuator.
<b>CC-030</b>	F/male - F/male (1m) coaxial cable.
<b>CC-042</b>	LNB power cable.
<b>DC-229</b>	Carrying case.
<b>DC-286</b>	Carrier belt.



## 7 MAINTENANCE

### 7.1 Instructions for returning by mail

Instruments returned for repair or calibration, either within or outwit the guarantee period, should be forwarded with the following information: Name of the Company, name of the contact person, address, telephone number, receipt (in the case of coverage under guarantee) and a description of the problem or the service required.

### 7.2 Method of maintenance

The method of maintenance to be carried out by the user consists of cleaning the cover and changing the battery. All other operations should be carried out by authorised agents or by personnel qualified in the servicing of instruments.

If the instrument does not respond to the controls for any unknown reason, switch it off by pressing the disconnection key for a few seconds and then turn it on again.

### 7.3 Cleaning the cover

**CAUTION:** Do not use scented hydrocarbons or chlorized solvents. Such products may attack the plastics used in the construction of the cover. The cover should be cleaned by means of a light solution of detergent and water applied with a soft cloth. Dry thoroughly before using the system again.

**CAUTION:** To clean the contacts, use a dry cloth. Do not use a wet or damp cloth.

**CAUTION:** Do not use for the cleaning of the front panel and particularly the viewfinders, alcohol or its derivatives, these products can attack the mechanical properties of the materials and diminish their useful time of life.



**7.4 Components which user can not replace**

**7.4.1 Not replaceable fuses by user**

<b>F003:</b>	<b>FUS 0.5 A</b>	<b>T 125 V</b>
<b>F004:</b>	<b>FUS 2.5 A</b>	<b>T 125 V</b>
<b>F005:</b>	<b>FUS 7 A</b>	<b>T 125 V</b>





## ANNEX 1 OP-012-O: DVB-T (COFDM) option

### A1.1 Description





Digital Terrestrial Television signals use a very complex modulation scheme called **COFDM** (Coherent Orthogonal Frequency Division Multiplexing). COFDM technique divides the width of a television channel (7 or 8 MHz) in many portions, as many as thousands. Each of those portions is occupied by a modulated carrier, using 16 or 64 QAM like in digital cable TV (DVB-C). Even though the symbol rate used by the individual carriers is small they are thousands in number and therefore the overall transmission capacity is enough to support various TV programs using the bandwidth of a single analogue channel. Most DTT systems are based on 8K-COFDM using almost 6817 carriers modulated at 16 or 64 QAM.

The DVB-T (COFDM) option displays the constellation for those carriers forming the COFDM multiplex and also the measures related.

**NOTE:**

- This option is available under request.
- This option needs a specific hardware implementation for full operation.
- Even if DVB-T option is available in the equipment menu, it will not work unless hardware changes are made. If hardware is not installed, then it will appear the message "COFDM OPTION NOT INSTALLED".

### A1.2 Selecting the DVB-T (COFDM) option

- 1 Press the **CH-FR**  key.
- 2 Press the **CONFIG**  key.
- 3 It displays the FR CONFIG 1/2 screen. In the MODO FREQ. option select DIG.
- 4 Press again the **CONFIG**  key.
- 5 It displays the FR CONFIG 2/2. In the SYSTEM option select DVB-T.
- 6 Press again the **CH-FR**  key to come back to "Input Channel Power" screen.



### A1.3 DVB-T (COFDM) signal measurement

In this mode, you can make two types of measurements. To switch between them, you must press once or twice the rotary knob. The measurements are:

#### ■ Input Channel Power

To access this measurement, press **CH-FR**  key and select a channel or frequency to measure.

To switch between channel tuning and frequency tuning, press the **CH-FR**  key.

This mode shows the power level of the input channel. It is represented by a bar graph and in numeric value. It also measures the C/N ratio (carrier/noise).

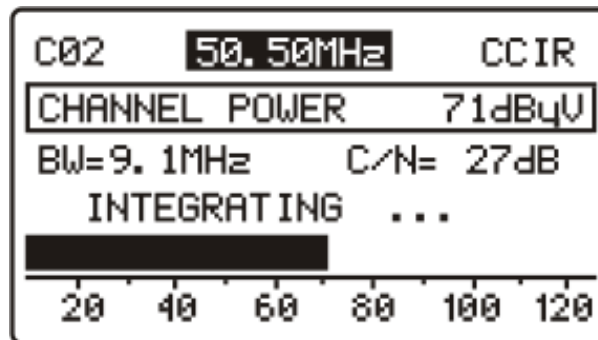



Figure A1.1

#### ■ Constellation Diagram

To access this measurement, from the **Input Channel Power** screen, **press once** the rotary knob .

To come back to the **Input Channel Power** screen, **press twice** the rotary knob .

In this mode is shown the **Constellation Diagram** of the tuned signal and other related measures:

- Guard interval (G).
- Carriers (C).
- Code Rate (CR).
- Carriers modulation type.



- VBER: Error rate obtained for the Pre-BER digital signal (BER before FEC).
- CBER: Error rate obtained for the Post-BER digital signal (BER after FEC).
- Error rate of modulation (MER).
- Quadrant shown. (ALL, Q1, Q2, Q3, Q4, Q1+, Q2+, Q3+, Q4+).
- Locked (encoding type) or unlocked.

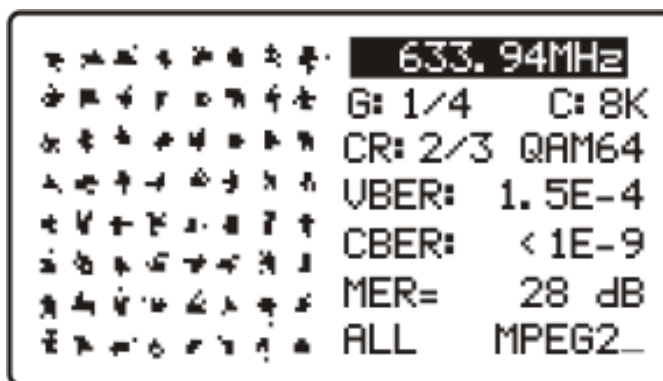

Figure A1.2.

### A1.3 Specifications

#### DVB-T MEASUREMENTS

<b>Modulation</b>	COFDM.
<b>Margin of power measurement</b>	From 35 dBμV to 120 dBμV.
<b>Measures</b>	Power, CBER, VBER, MER and C/N.
<b>Displayed data</b>	Numeric, level bar and constellation.
<b>Carriers</b>	2k, 8k.
<b>Guard Interval</b>	1/4, 1/8, 1/16, 1/32.
<b>Code Rate</b>	1/2, 2/3, 3/4, 5/6, 7/8.
<b>Constellation</b>	QPSK, 16-QAM, 64-QAM.



ANNEX 2 CARRIER / NOISE RATIO MEASUREMENT (C/N)

Limits of C/N measurements of Promax 12

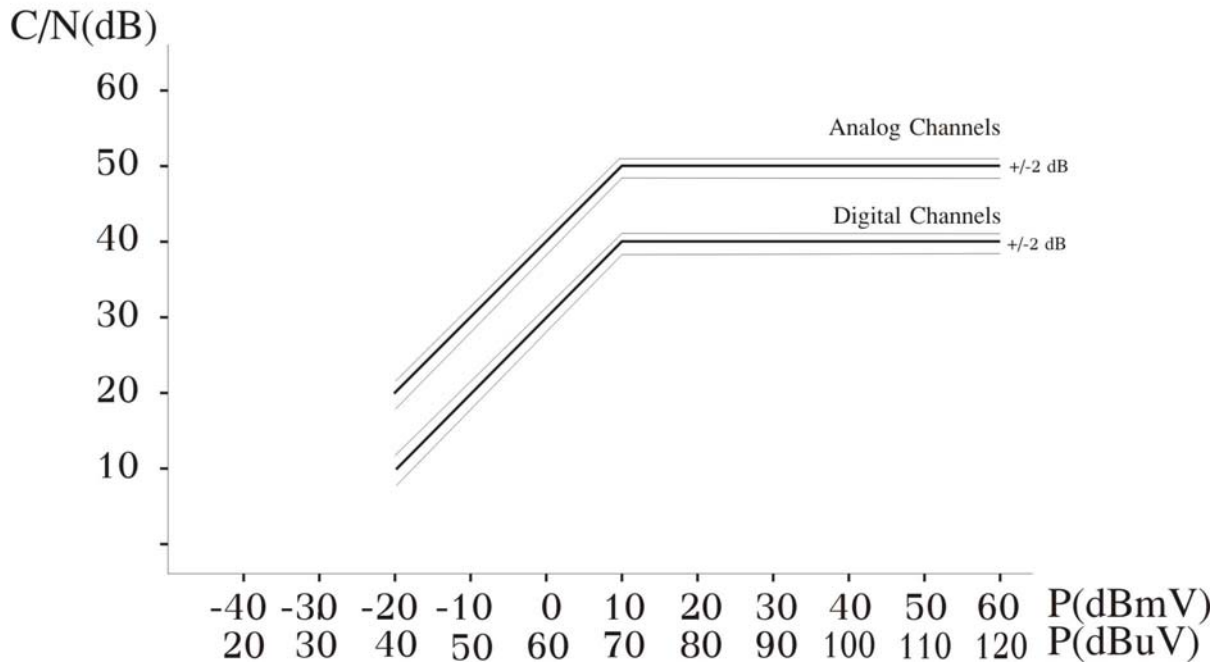



**PROMAX ELECTRONICA, S. L.**

Francesc Moragas, 71-75  
08907 L'HOSPITALET DE LLOBREGAT (Barcelona)  
SPAIN  
Tel. : 93 184 77 00 \* Tel. Intl. : (+34) 93 184 77 02  
Fax : 93 338 11 26 \* Fax Intl. : (+34) 93 338 11 26  
<http://www.promaxelectronics.com>  
e-mail: [promax@promaxelectronics.com](mailto:promax@promaxelectronics.com)