

Yealink



Yealink Network Technology CO., LTD

Yealink MVC II Series for Microsoft Teams Rooms System

Quick Start Guide(V2.0)

English | 简体中文

Package Contents

• MVC900 II Package

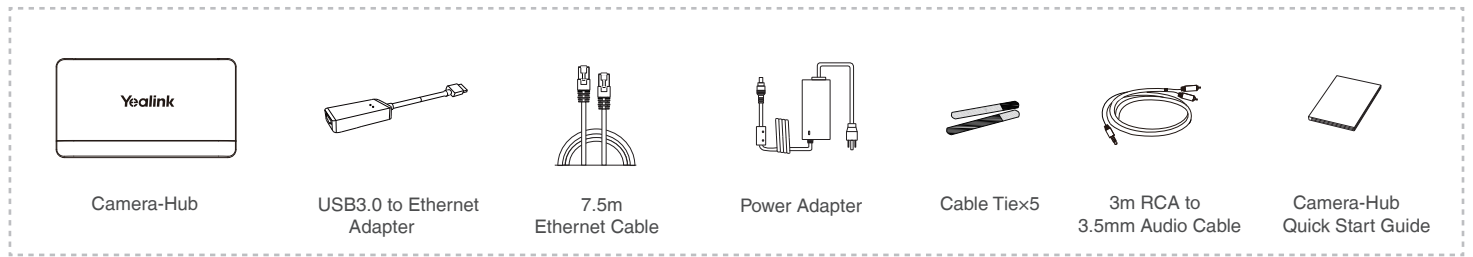

Camera-Hub Package

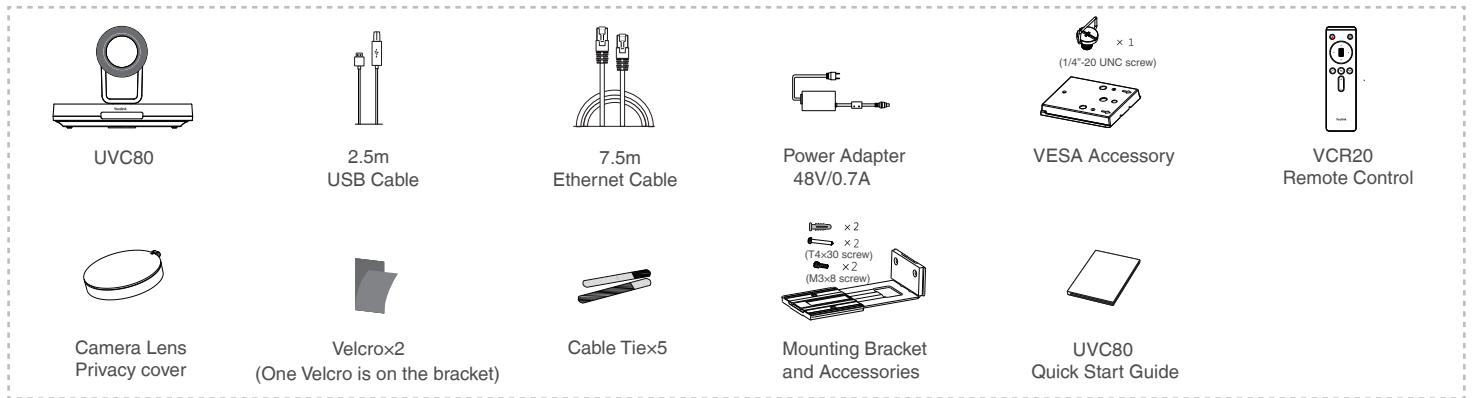

UVC80 Package (Camera)x2

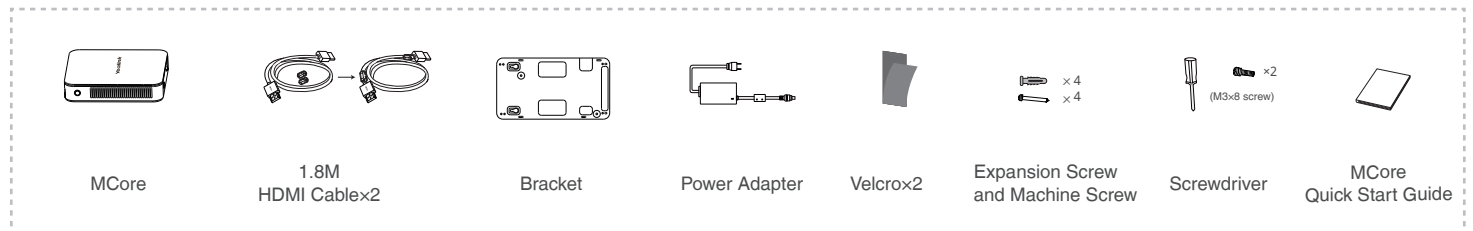

MCore Package

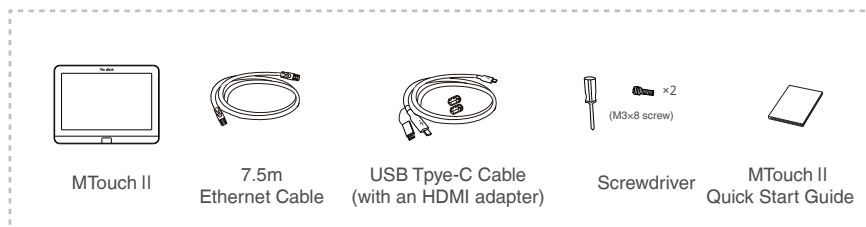

MTouch II Package (Touch Console)

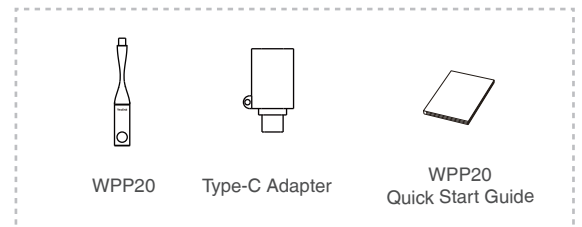

WPP20 Wireless Sharing Package x2

• MVC800 II Package

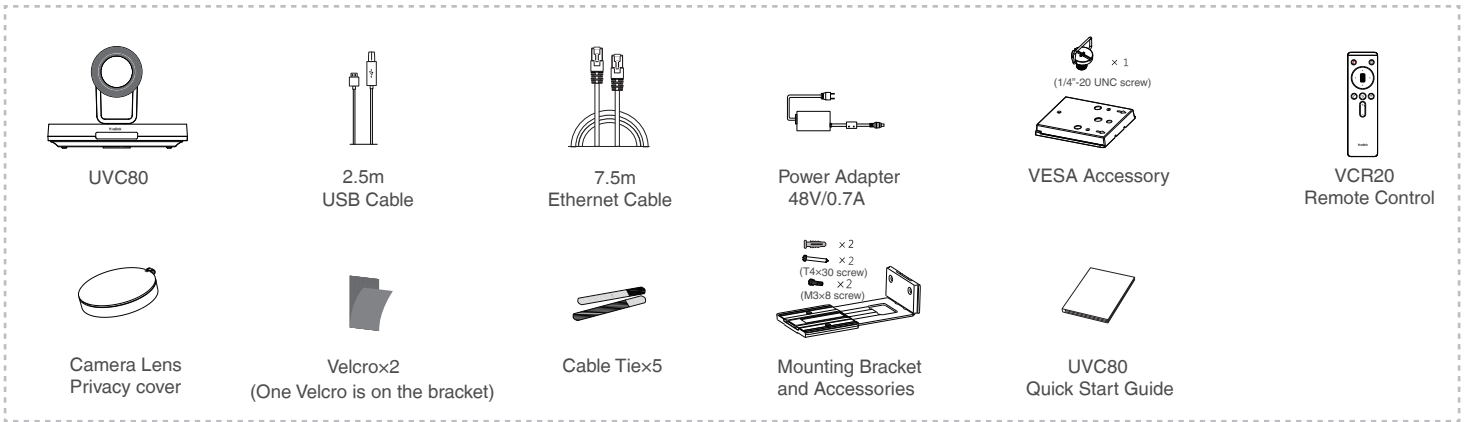

UVC80 Package (Camera)

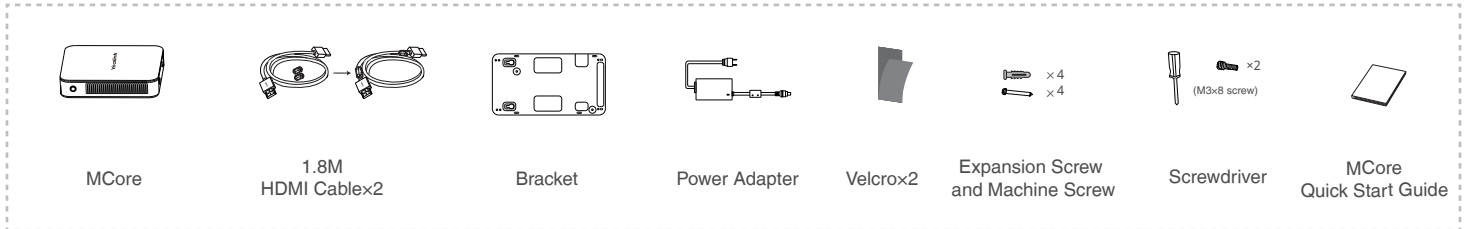

MCore Package

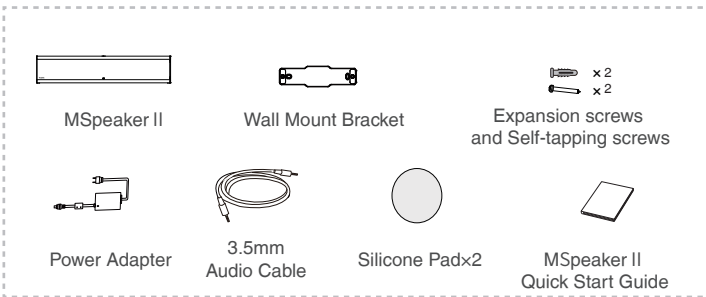

MSpeaker II Package (Soundbar)

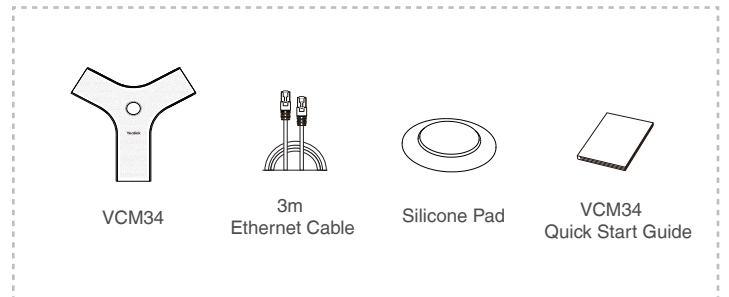

VCM34 Package×2 (Microphone)

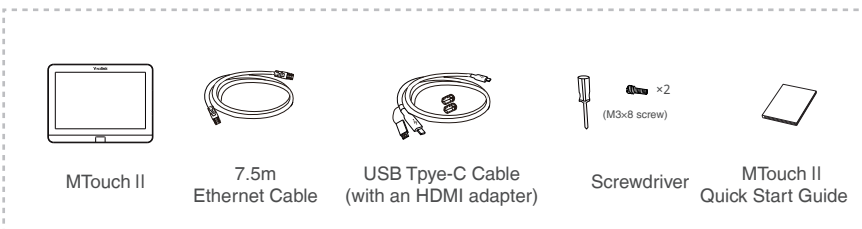

MTouch II Package (Touch Console)

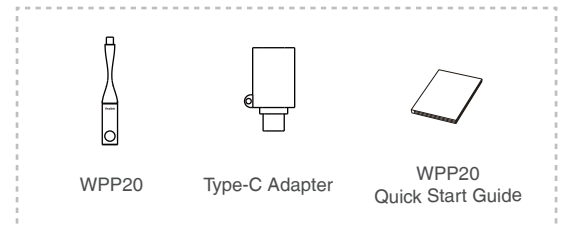

(Optional) WPP20 Wireless Sharing Package

• MVC500 II Package

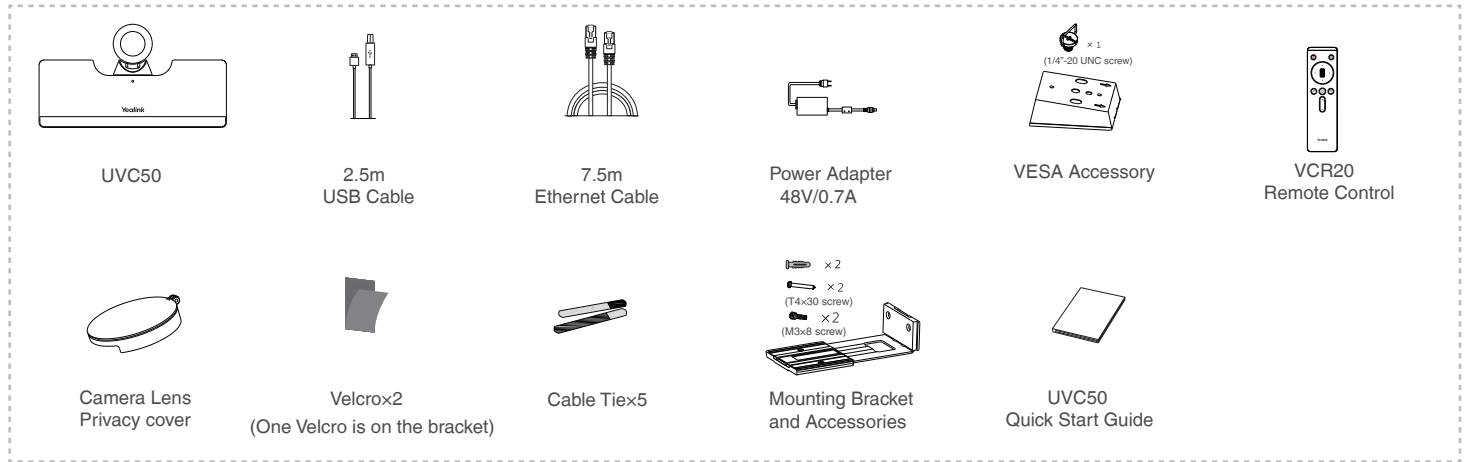

UVC50 Package (Camera)

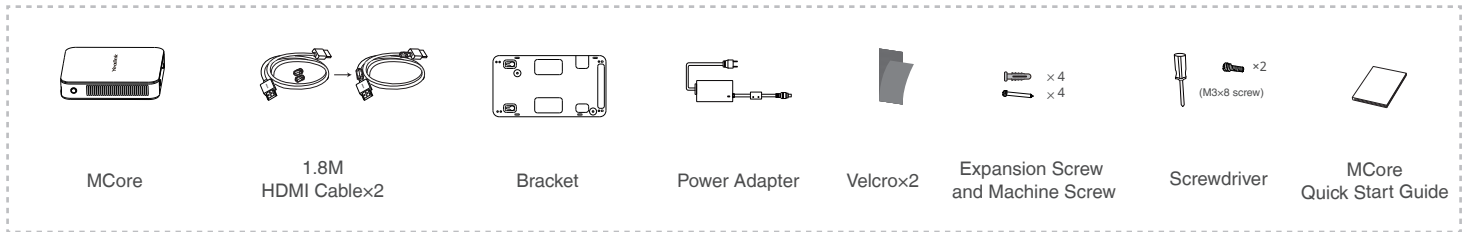

MCore Package

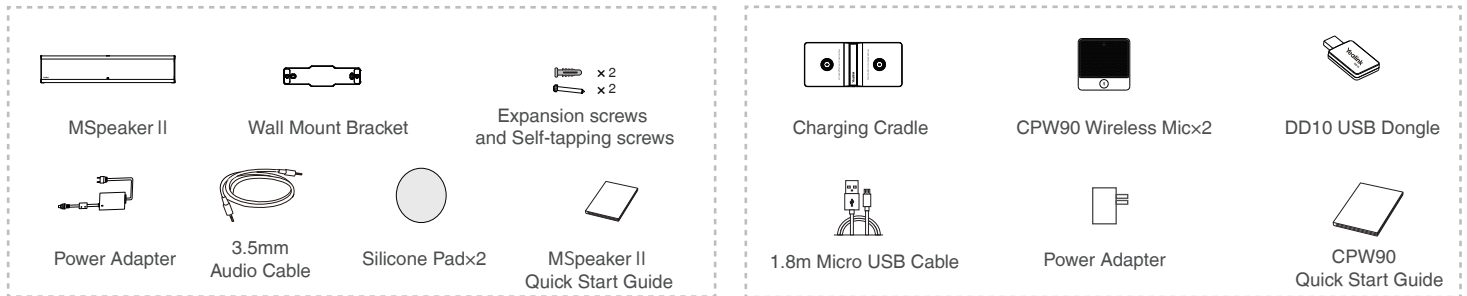

MSpeaker II Package (Soundbar)

CPW90 Package (Microphone)

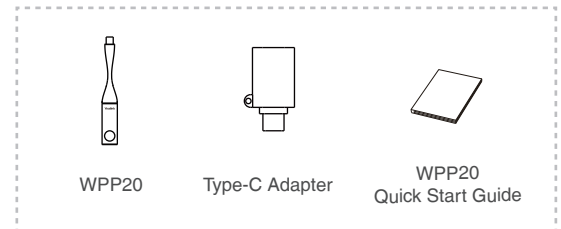
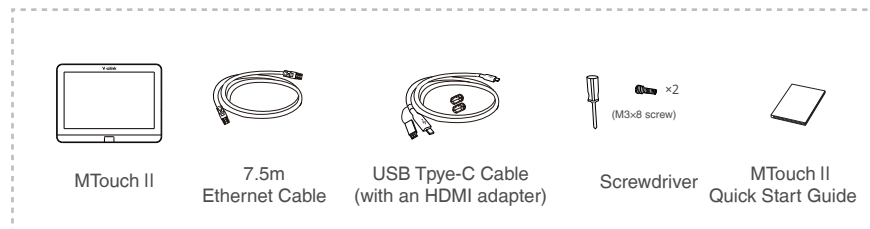

MTouch II Package (Touch Console)

(Optional) WPP20 Wireless Sharing Package

• MVC300 II Package

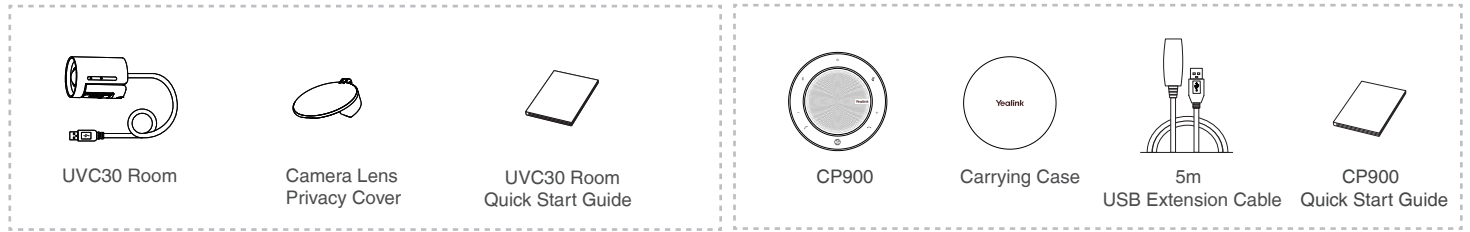

UVC30 Room Package (Camera)

CP900 Package (Microphone)

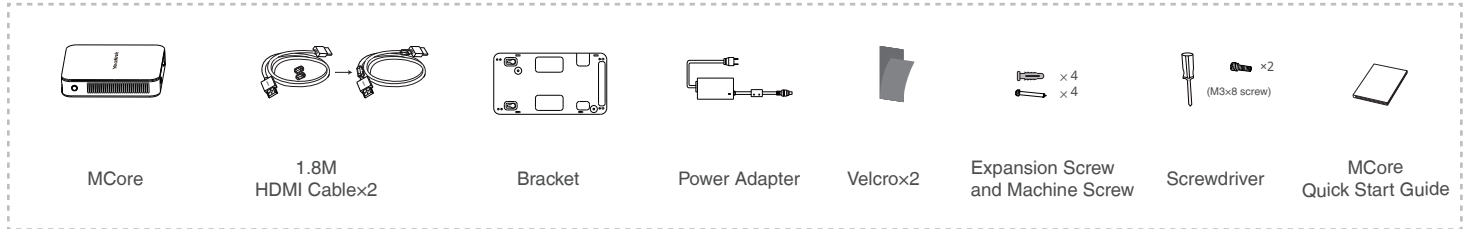

MCore Package

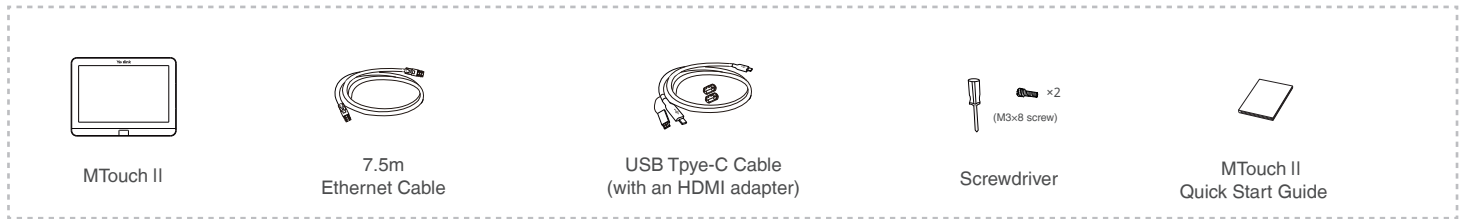

MTouch II Package (Touch Console)

💡 We recommend that you use the accessories provided or approved by Yealink. The use of unapproved third-party accessories may result in poor performance.

MVC900 II & MVC800 II & MVC500 II & MVC300 II Connection

MVC900 II Connection

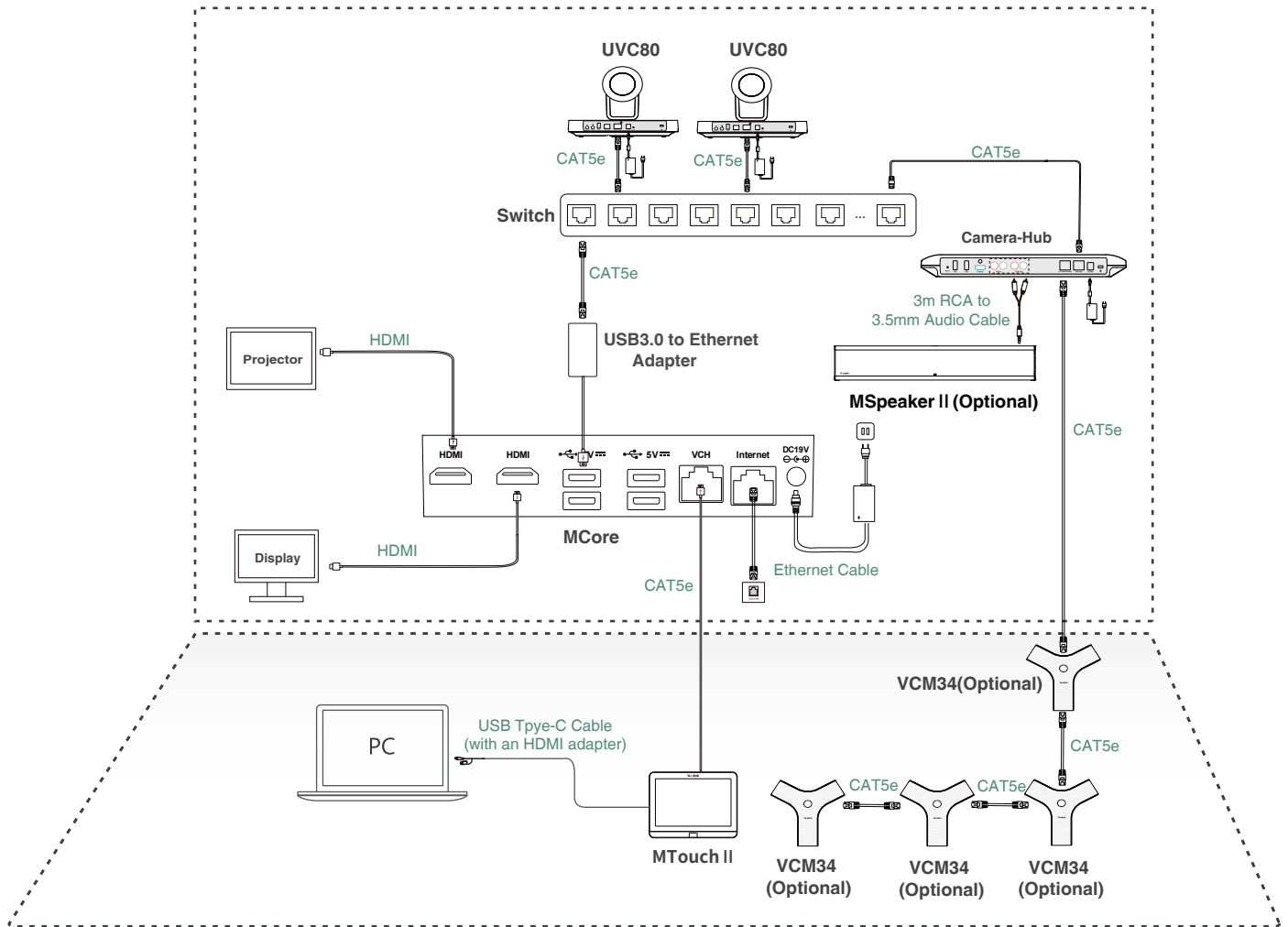

- 💡 Do not connect the switch to the Internet, otherwise it will cause network abnormalities.
- 💡 The switch and ethernet cables should be purchased separately.
- 💡 When starting up the system for the first time, you need to connect a mouse to complete the initial configuration.
We recommend using the wireless mouse and keyboard kit.
- 💡 For more information about the installation and deployment of accessories (for example, the installation of MCore package or the camera-hub), refer to the Quick Start Guide of corresponding accessory.

MVC800 II & MVC500 II Connection

The connection of MVC500 II is almost the same as that of MVC800 II .

The following is an example of connecting MVC800 II .

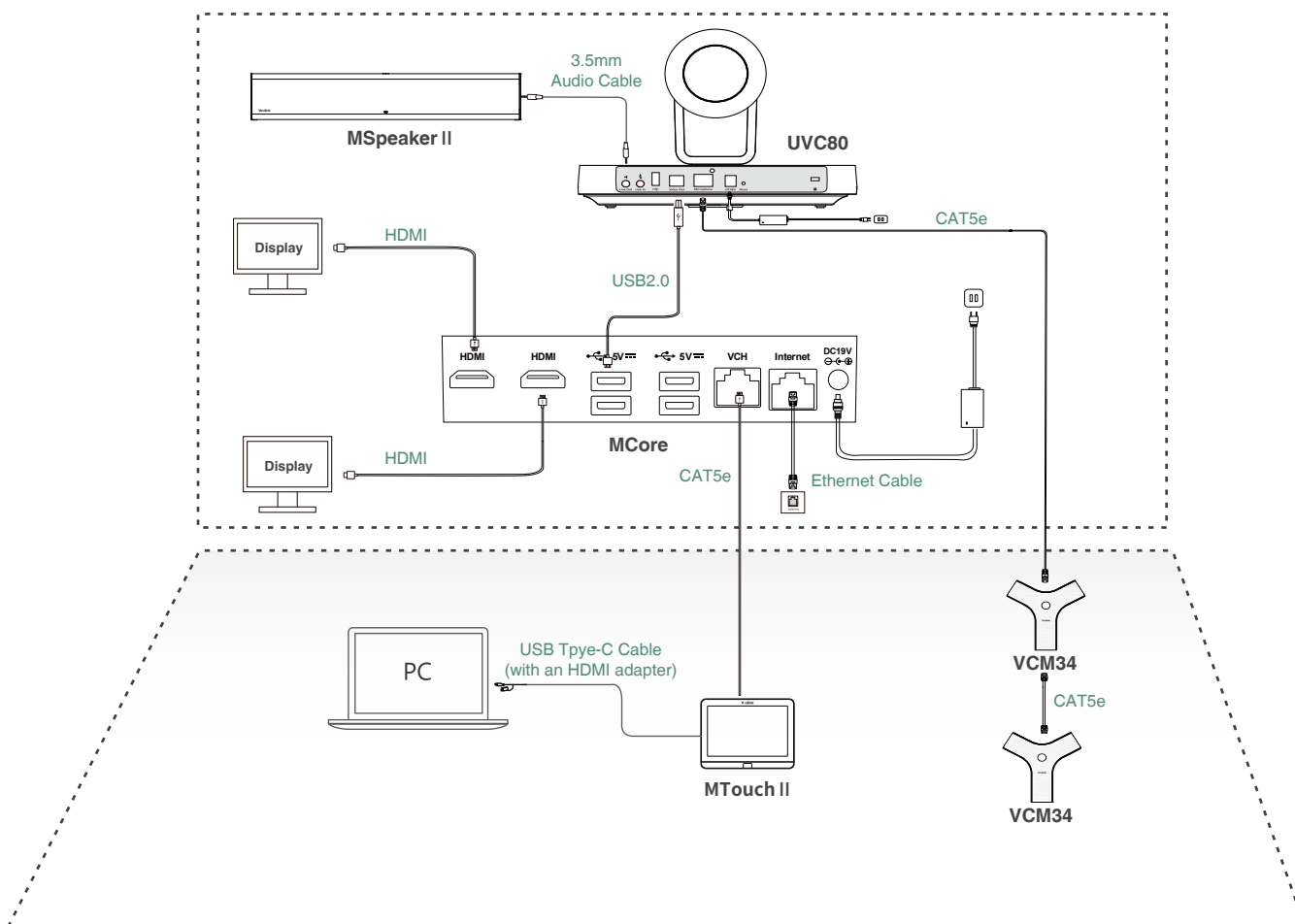

- 💡 You can use VCM34 or CPW90 as microphone.
- 💡 When starting up the system for the first time, you need to connect a mouse to complete the initial configuration. We recommend using the wireless mouse and keyboard kit.
- 💡 For more information about the installation and deployment of accessories (for example, the installation of MCore package or the UVC80 camera), refer to the Quick Start Guide of corresponding accessory.

MVC300 II Connection

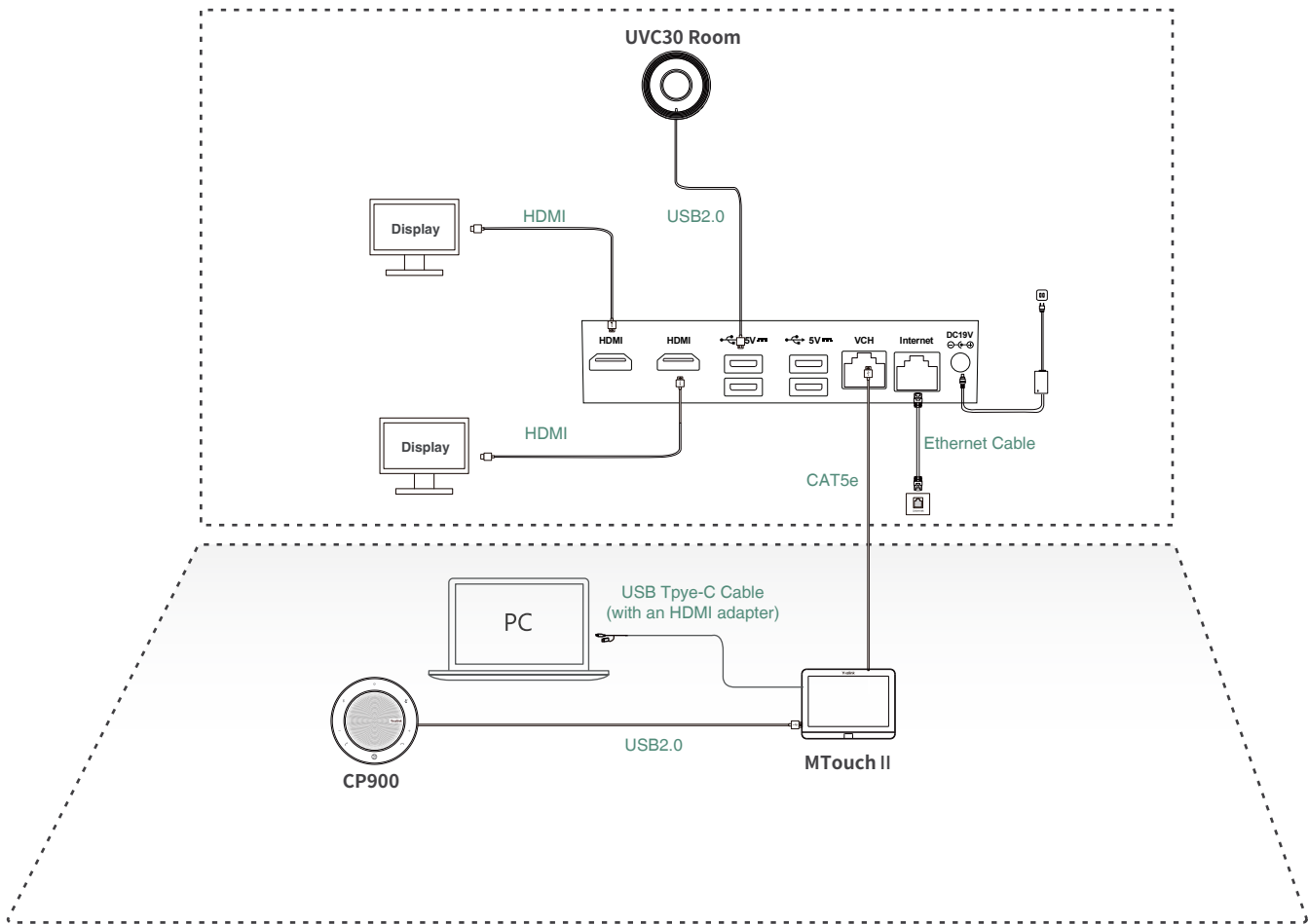

💡 When starting up the system for the first time, you need to connect a mouse to complete the initial configuration. We recommend using the wireless mouse and keyboard kit.

💡 For more information about the installation and deployment of accessories (for example, the installation of the MCore package or the UVC30 Room camera), refer to the Quick Start Guide of corresponding accessory.

Wireless Sharing

You can use Yealink WPP20 wireless presentation pod for wireless content sharing. WPP20 needs to be purchased separately.

Make sure the MTouch II is connected to the MCore.

Procedure

1. Connect the WPP20 to the USB port of the MTouch II .
2. Wait for about 3 seconds, the WPP20 LED indicator glows solid green.
The WPP20 is paired with the MTouch II successfully.
3. Connect the WPP20 to the PC.



Upgrading System Software through Windows Update

The system software(including the Windows, the Camera-Hub/UVC80/UVC50/UVC30 Room, the MTouch II) can be automatically upgraded via windows update by default.

Otherwise, you can enable automatically windows update or upgrade the devices manually.

Enabling Automatically Windows Update

Procedure

1. On the display screen, navigate to **More->Settings**.
2. Enter the administrator password (default: sfb) to access **Setup** screen.
3. Navigate to **Windows Settings**.
4. Select **Administrator** from the bottom-left corner and then enter the administrator password (default: sfb).
5. Tap the Start button, and then go to **Settings->Upgrade & Security->Windows Update**, and select **Advanced options**.
6. Enable **Automatically download updates, even over metered data connections (charge may apply)**.

Manually Windows Update



Procedure

1. On the display screen, navigate to **More->Settings**.
2. Enter the administrator password (default: sfb) to access **Setup** screen.
3. Navigate to **Windows Settings**.
4. Select **Administrator** from the bottom-left corner and then enter the administrator password (default: sfb).
5. Do one of the following:
 - Long tap the Start button, and then select **Device Manager**.
Select the desired device and then long tap the device to select **Update driver**.
Select a desired way to update.
 - Tap the Start button, and then navigate to **Settings->Upgrade & Security->Windows Update**, and select **Check for updates**.
Select the desired device and then complete the installation.

 The software upgrade is only supported by the operating system of 64-bit Windows 10.





Enabling/Disabling Auto-framing

Procedure

1. Tap **More**->  to enter the **Camera Control** page.
2. Select  .
3. Enable/Disable **Auto-framing**.

Controlling UVC80/UVC50/UVC30 Room Camera Position

Procedure

1. Tap **More**->  to enter the **Camera Control** page.
 2. If you are using MVC900 II system, select a desired UVC80 camera.
 3. Tap  or  to zoom camera in/out.
 4. Tap the arrow keys to pan/tilt the camera.
-  If the auto-framing feature is enabled, you can not control the UVC30 Room camera.

Resetting UVC80/UVC50/UVC30 Room Camera to Home Position

Procedure

1. Tap **More**->  to enter the **Camera Control** page.
2. If you are using MVC900 II system, select a desired UVC80 camera.
3. Tap **Reset**.

包装清单

• MVC900 II 产品包

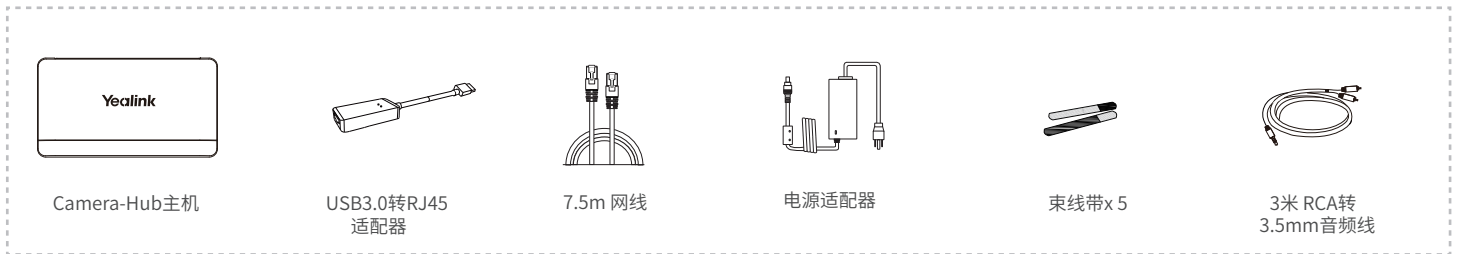

Camera-Hub主机套件



UVC80套件(摄像机) × 2

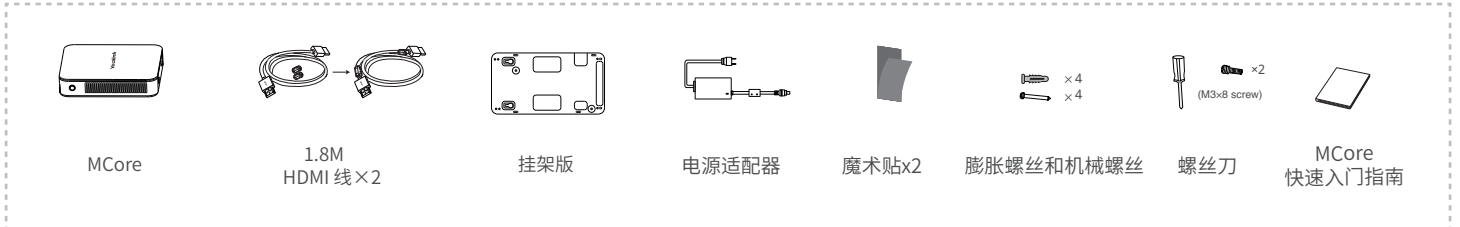

MCore套件

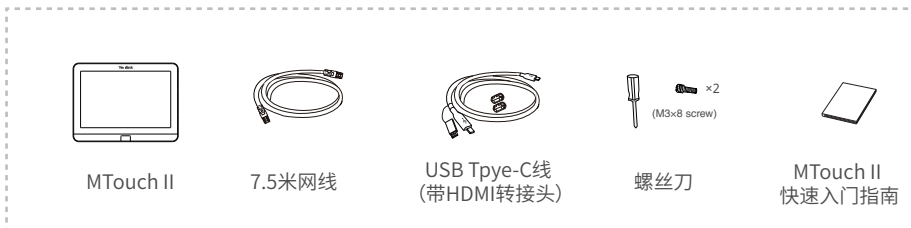

MTouch II 套件(触控平板)

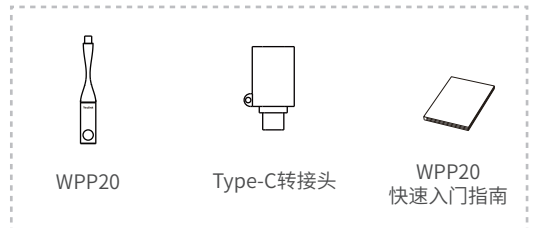

WPP20无线投屏套件 × 2

• MVC800 II 产品包

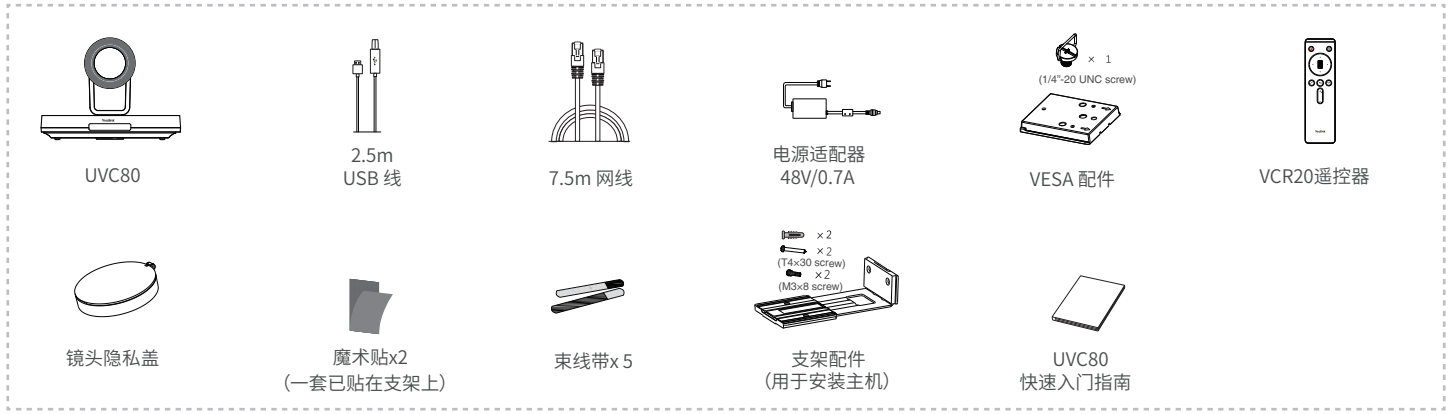

UVC80套件(摄像机)

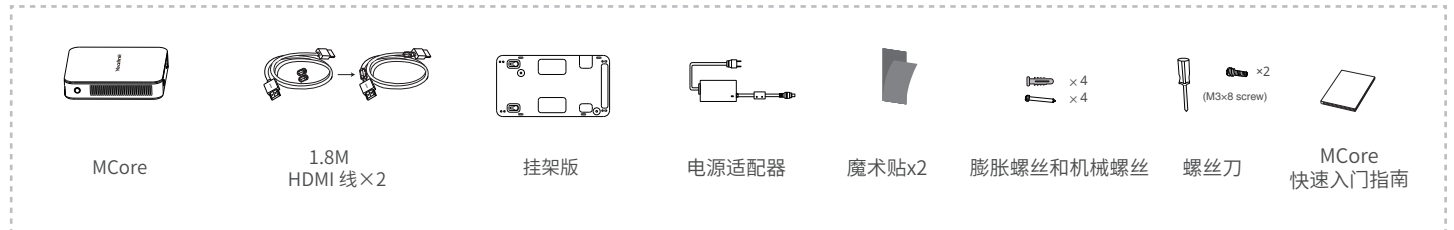

MCore套件

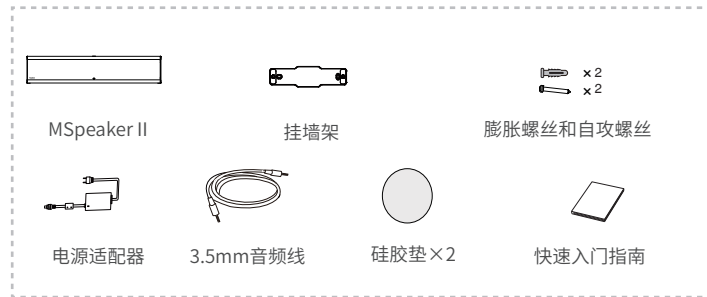

MSpeaker II 套件 (音箱)

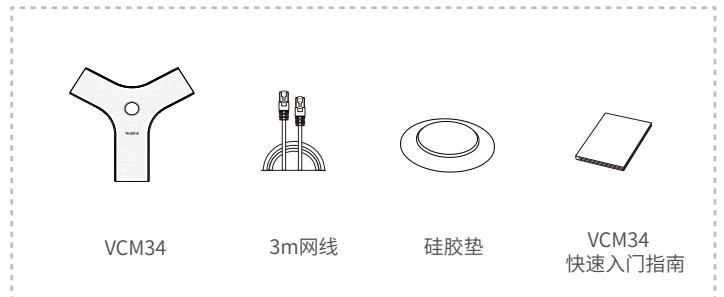

VCM34 套件×2 (麦克风)



MTouch II 套件(触控平板)

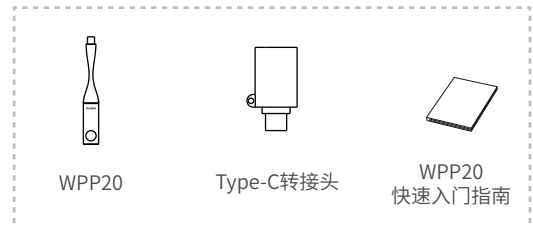

(可选)WPP20无线投屏套件

• MVC500 II 产品包

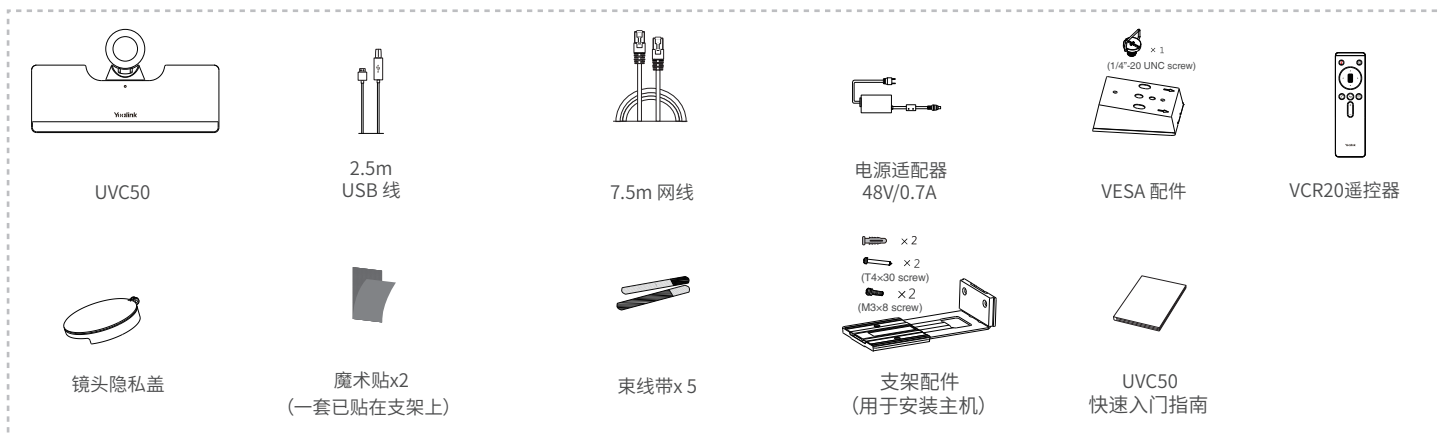

UVC50套件(摄像机)

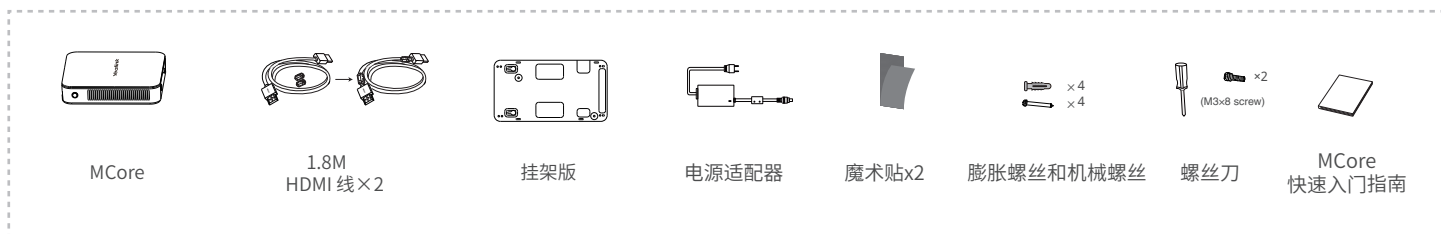

MCore套件



MSpeaker II 套件 (音箱)

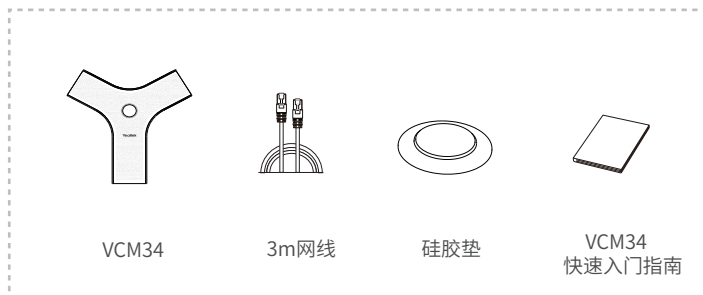

VCM34 套件 (麦克风)



MTouch II 套件(触控平板)

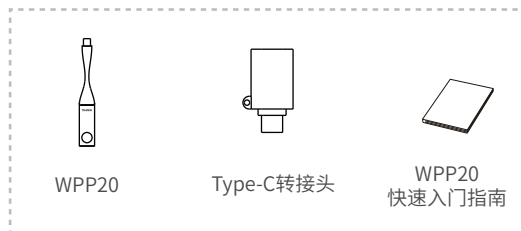

(可选)WPP20无线投屏套件

• MVC300 II 产品包

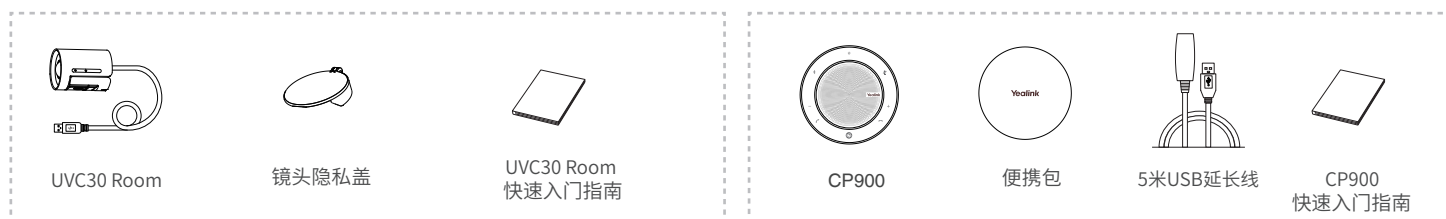

UVC30 Room套件(摄像机)

CP900套件 (USB 扬声器)

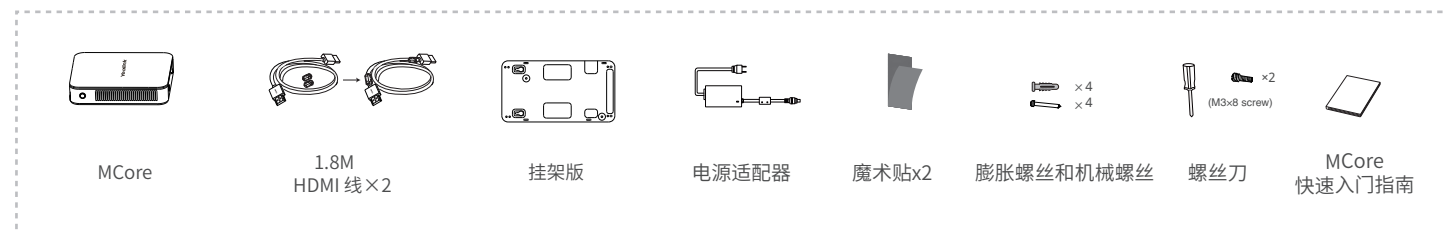

MCore套件



MTouch II 套件 (触控平板)

💡 我们推荐使用由Yealink提供或经Yealink认可的配件和线缆，使用未经认可的第三方配件和线缆可能会导致性能的下降。

连接MVC900 II & MVC800 II & MVC500 II & MVC300 II

连接MVC900 II

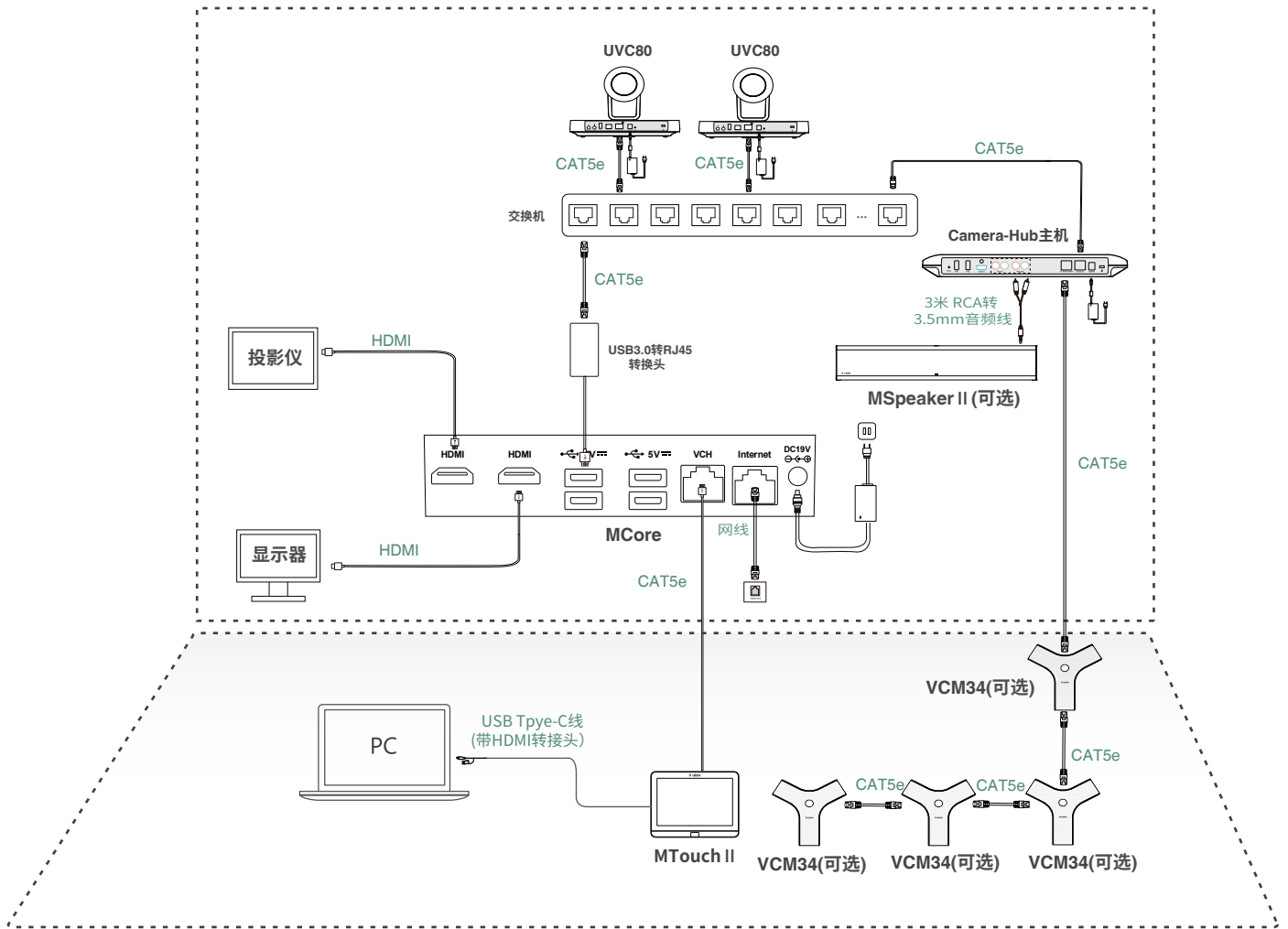

- 💡 请勿将交换机接入Internet, 否则会引起网络异常。
- 💡 交换机和相关网线需要另外购买。
- 💡 首次启动时, 你需要在MCore上接一个鼠标来完成系统初始化配置, 我们推荐使用无线键鼠套装。
- 💡 更多关于如何安装和部署配件(例如安装MCore或UVC80摄像机), 请参阅相应配件的快速入门指南。

连接MVC800 II & MVC500 II

MVC500 II 的连接与MVC800 II 的连接相似, 下图为MVC800 II 的连接示例。

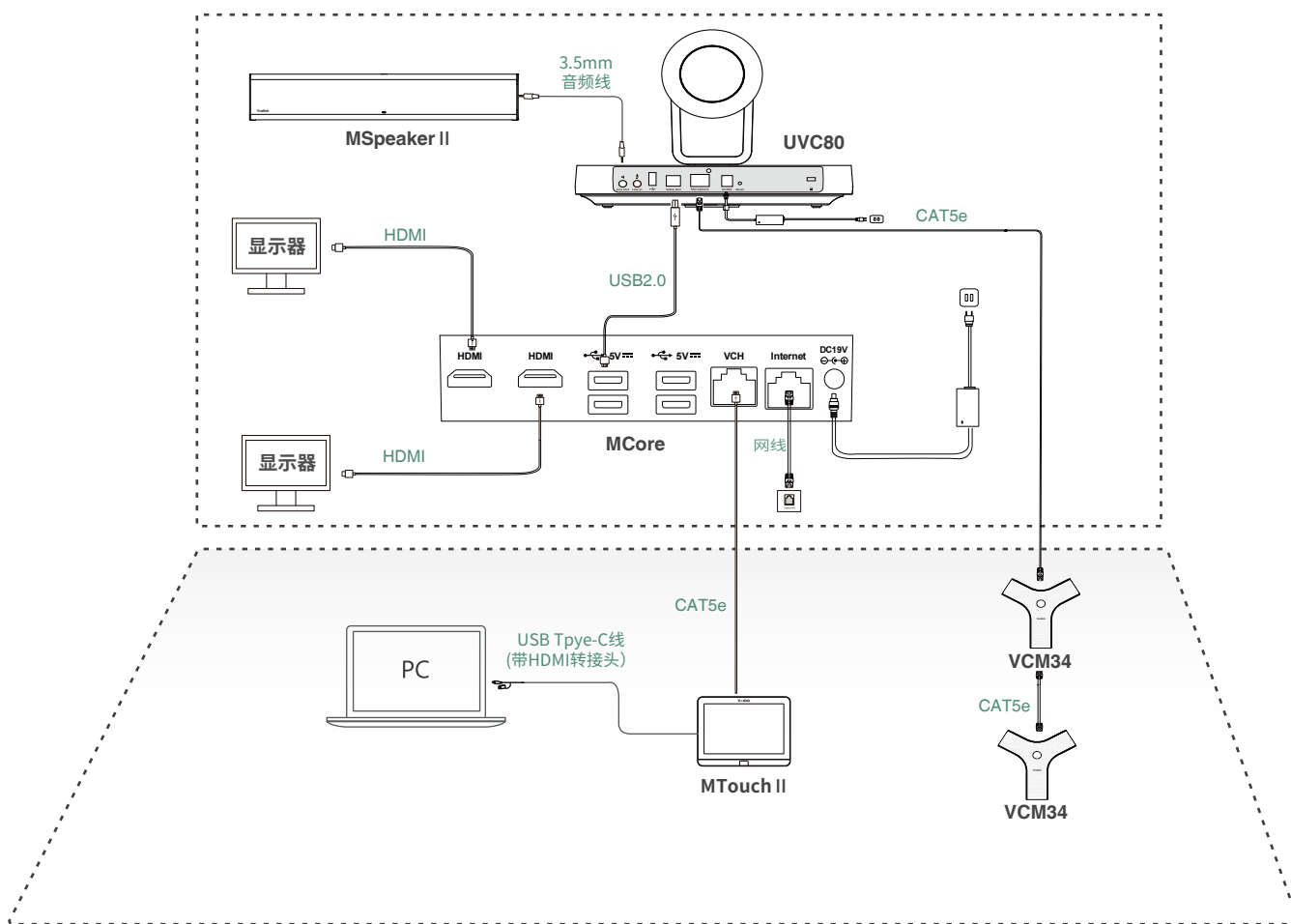

💡 首次启动时, 你需要在MCore上连接一个鼠标来完成系统初始化配置, 我们推荐使用无线键鼠套装。

💡 更多关于如何安装和部署配件(例如安装MCore或UVC80摄像机), 请参阅相应配件的快速入门指南。

连接MVC300 II

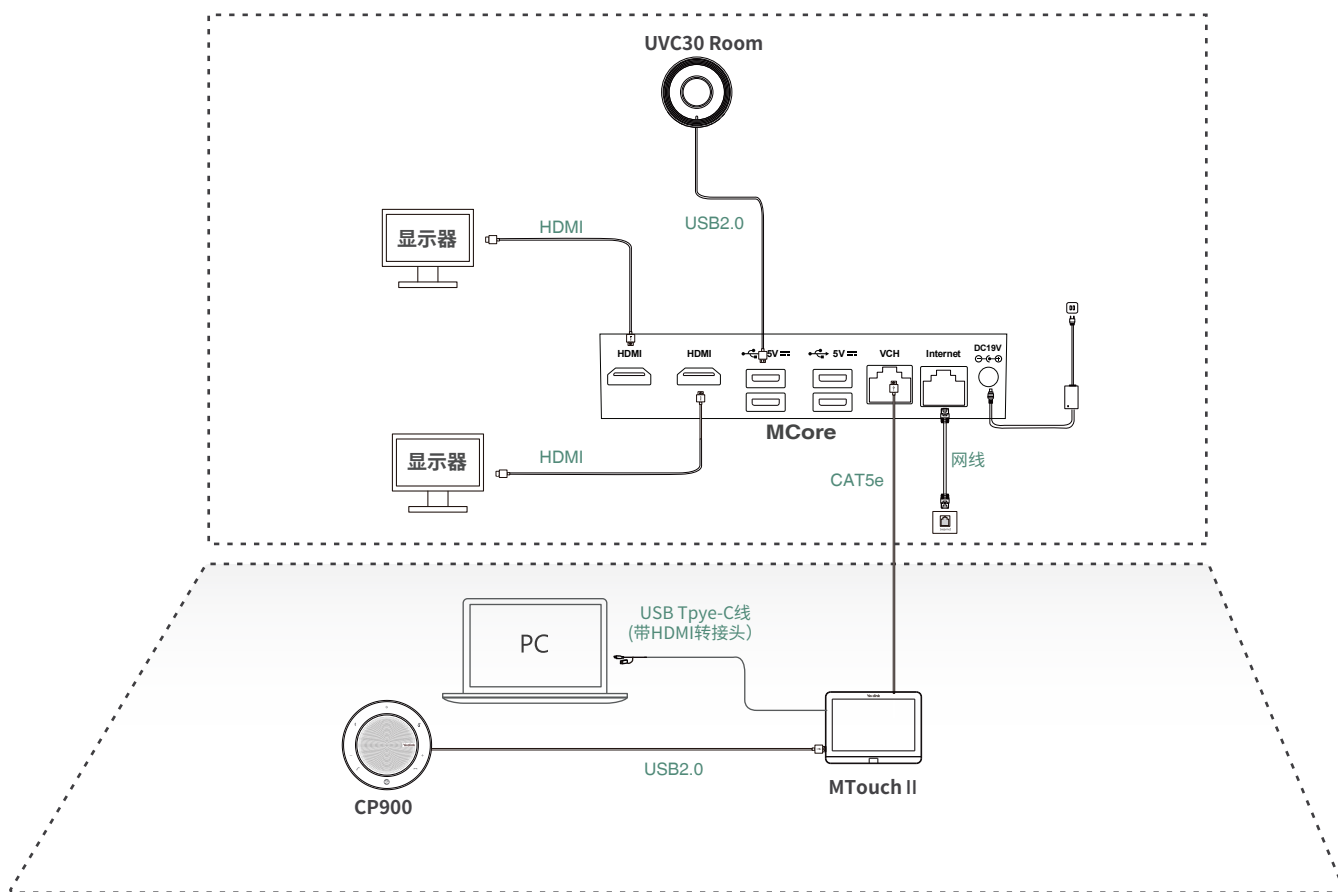

💡 首次启动时,你需要在MCore上连接一个鼠标来完成系统初始化配置,我们推荐使用无线键鼠套装。

💡 更多关于如何安装和部署配件(例如安装MCore或UVC30 Room摄像机),请参阅相应配件的快速入门指南。

无线辅流分享内容

你可以使用WPP20无线传屏助手进行无线辅流分享内容。WPP20需要单独购买。分享内容前,确保MTouch II已正确连接在MCore上。

过程

1. 将WPP20连接到MTouch II的USB口。
2. 约3秒后,WPP20指示灯显示绿色常亮。
WPP20与MTouch II配对成功。
3. 将WPP20连接到电脑上。



通过Windows更新系统

系统软件(包括Windows, Camera-Hub/UVC80/UVC50/UVC30 Room和 MTouch II)默认情况下可以通过windows 自动更新升级。如果设备软件没有自动升级,你可以启用自动windows 自动更新或手动升级设备。

开启Windows自动更新

过程

1. 在显示屏上,按**更多->设置**。
2. 输入管理员密码(默认:sfb)进入**设置**界面。
3. 按 **Windows设置**。
4. 从左下角选择**Administrator**帐户,并输入管理员帐户密码(默认:sfb)。
5. 按开始菜单,选择**设置->更新和安全->Windows更新**,再按**高级选项**。
6. 开启**自动下载更新**,即使通过按流量计费的数据连续也是如此(可能会收费)。

手动更新升级设备

过程

1. 在显示屏上,按**更多->设置**。
2. 输入管理员密码(默认:sfb)进入**设置**界面。
3. 按 **Windows设置**。
4. 从左下角选择**Administrator**帐户,并输入管理员帐户密码(默认:sfb)。
5. 执行以下任一操作:
 - 长按开始菜单,选择**设备管理器**。
选择并长按需要更新的设备,并选择**更新驱动程序**。
选择需要更新的方式。
 - 按开始菜单,选择**设置->更新和安全->Windows更新**,选择**检查更新**。
选择需要更新的设备,并完成安装。

💡 仅64位Windows 10操作系统支持软件升级。



开启/关闭自动框全景

过程

1. 按**更多**->  进入**摄像机控制**界面。
2. 选择  。
3. 开启/关闭**自动框全景**。

控制UVC80/UVC50/UVC30 Room摄像头位置

过程

1. 按**更多**->  进入**摄像机控制**界面。
2. 如果使用MVC900 II 系统, 选择相应的UVC80摄像机。
3. 按  或  调整摄像机的焦距。
4. 按方向键调整摄像机角度。

 UVC30 Room摄像机开启自动框全景功能后, 无法控制摄像头。

恢复UVC80/UVC50/UVC30 Room摄像头到主位置

过程

1. 按**更多**->  进入**摄像机控制**界面。
2. 如果使用MVC900 II 系统, 选择相应的UVC80摄像机。
3. 按**重置**。

Regulatory Notices

Operating Ambient Temperatures

- Operating temperature: +32 to 104°F (0 to 40°C)
- Relative humidity: 5% to 90%, noncondensing
- Storage temperature: -22 to +160°F (-30 to +70°C)

Warranty

Our product warranty is limited only to the unit itself, when used normally in accordance with the operating instructions and the system environment. We are not liable for damage or loss resulting from the use of this product, or for any claim from a third party. We are not liable for problems with Yealink device arising from the use of this product; we are not liable for financial damages, lost profits, claims from third parties, etc., arising from the use of this product.

Explanation of the symbols

● DC symbol

--- is the DC voltage symbol.

● WEEE Warning symbol

 To avoid the potential effects on the environment and human health as a result of the presence of hazardous substances in electrical and electronic equipment, end users of electrical and electronic equipment should understand the meaning of the crossed-out wheeled bin symbol. Do not dispose of WEEE as unsorted municipal waste and have to collect such WEEE separately.

Restriction of Hazardous Substances Directive (RoHS)

This device complies with the requirements of the EU RoHS Directive. Statements of compliance can be obtained by contacting support@yealink.com.

Safety Instructions

Save these instructions. Read these safety instructions before use!

General Requirements

- Before you install and use the device, read the safety instructions carefully and observe the situation during operation.
- During the process of storage, transportation, and operation, please always keep the device dry and clean, avoid collision and crash.
- Please attempt not to dismantle the device by yourself. In case of any discrepancy, please contact the appointed maintenance center for repair.
- Please refer to the relevant laws and statutes while using the device. Legal rights of others should be respected as well.

Environmental Requirements

- Place the device at a well-ventilated place. Do not expose the device under direct sunlight.
- Keep the device dry and free of dusts.
- Do not place the device on or near any inflammable or fire-vulnerable object, such as rubber-made materials.
- Keep the device away from any heat source or bare fire, such as a candle or an electric heater.

Operating Requirements

- Do not let a child operate the device without guidance.
- Do not let a child play with the device or any accessory in case of accidental swallowing.
- Please use the accessories provided or authorized by the manufacturer only.
- The power supply of the device shall meet the requirements of the input voltage of the device. Please use the provided surge protection power socket only.
- Before plugging or unplugging any cable, make sure that your hands are completely dry.
- Do not spill liquid of any kind on the product or use the equipment near water, for example, near a bathtub, washbowl, kitchen sink, wet basement or near a swimming pool.

- During a thunderstorm, stop using the device and disconnect it from the power supply. Unplug the power plug and the Asymmetric Digital Subscriber Line (ADSL) twisted pair (the radio frequency cable) to avoid lightning strike.
- If the device is left unused for a rather long time, disconnect it from the power supply and unplug the power plug.
- When there is smoke emitted from the device, or some abnormal noise or smell, disconnect the device from the power supply, and unplug the power plug immediately.
- Contact the specified maintenance center for repair.
- Do not insert any object into equipment slots that is not part of the product or auxiliary product.
- Before connecting a cable, connect the grounding cable of the device first. Do not disconnect the grounding cable until you disconnect all other cables.

Cleaning Requirements

- Before cleaning the device, disconnect it from the power supply.
- Use a piece of soft, dry and anti-static cloth to clean the device.
- Keep the power plug clean and dry.

Troubleshooting

The unit cannot supply power to device other than Yealink device.

There is a bad connection with the plug.

1. Clean the plug with a dry cloth.
2. Connect it to another wall outlet.

The usage environment is out of operating temperature range.

1. Use in the operating temperature range.

The cable between the unit and the Yealink device is connected incorrectly.

1. Connect the cable correctly.

You cannot connect the cable properly.

1. You may have connected a wrong Yealink device.
2. Use the correct power supply.

Some dust, etc., may be in the port.

1. Clean the port.

Contact your dealer or authorized service facility for any further questions.

FCC Statement

This device complies with part 15 of the FCC Rules. Operation is subject to the following

two conditions: (1) this device may not cause harmful interference, and (2) this device must accept any interference received, including interference that may cause undesired operation.

Any Changes or modifications not expressly approved by the party responsible for compliance could void the user's authority to operate the equipment.

IC Statement

This device complies with Industry Canada's licence-exempt RSSs. Operation is subject to the following two conditions:

- (1) this device may not cause interference; and
 - (2) this device must accept any interference, including interference that may cause undesired operation of the device. CAN ICES-3(B)
- Le présent appareil est conforme aux CNR d'Industrie Canada applicables aux appareils radio exempts de licence. L'exploitation est autorisée aux deux conditions suivantes :
- (1) l'appareil ne doit pas produire de brouillage;
 - (2) l'utilisateur de l'appareil doit accepter tout brouillage radioélectrique subi, même si le brouillage est susceptible d'en compromettre le fonctionnement. NMB-3(B)

Contact Information

YEALINK NETWORK TECHNOLOGY CO.,LTD.

309, 3rd Floor, No.16, Yun Ding North Road, Huli District, Xiamen City, Fujian, P.R. C

YEALINK (EUROPE) NETWORK TECHNOLOGY B.V.

Strawinskylaan 3127, Atrium Building, 8th floor, 1077ZX Amsterdam, The Netherlands

YEALINK (USA) NETWORK TECHNOLOGY CO., LTD.

999 Peachtree Street Suite 2300, Fulton, Atlanta, GA, 30309, USA

Made in China

About Yealink

Yealink is a global leading provider of enterprise communication and collaboration solutions, offering video conferencing service to worldwide enterprises. Focusing on research and development, Yealink also insists on innovation and creation. With the outstanding technical patents of cloud computing, audio, video and image processing technology, Yealink has built up a panoramic collaboration solution of audio and video conferencing by merging its cloud services with a series of endpoints products. As one of the best providers in more than 140 countries and regions including the US, the UK and Australia, Yealink ranks No.1 in the global market share of SIP phones shipments.

Technical Support

Visit Yealink WIKI (<http://support.yealink.com/>) for the latest firmware, guides, FAQ, Product documents, and more. For better service, we sincerely recommend you to use Yealink Ticketing system (<https://ticket.yealink.com>) to submit all your technical issues.



430104001315

