











VC520+ Quick-Start Guide



Package Includes

Camera	Speakerphone	Remote	Power Supply + Power Cable	16' USB Cable
				
32' Speakerphone Cable	3' 3.5mm Aux Cable	Batteries (2x AAA)	Quick-Start Guide	L-Mount
				
Tripod screw	Drilling paper			
				

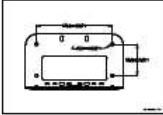
Hardware Installation Steps

1. Connect Camera to Power Outlet

2. Connect Camera to Speakerphone

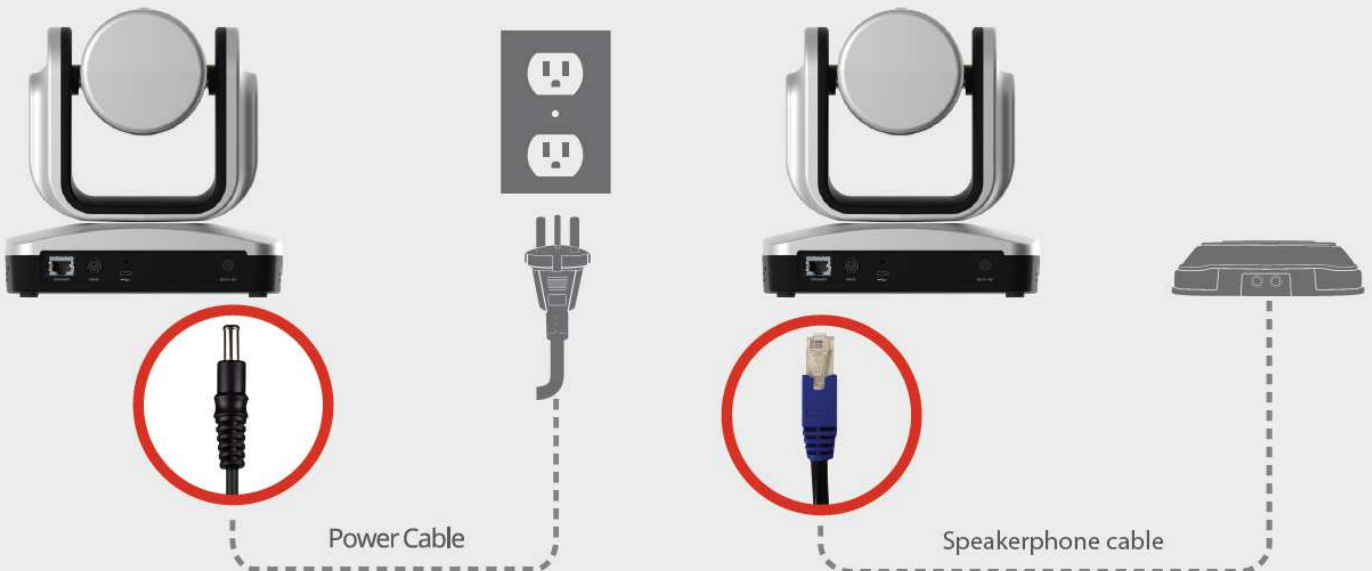

3. Connect Camera to Computer and Connect Computer to Monitor

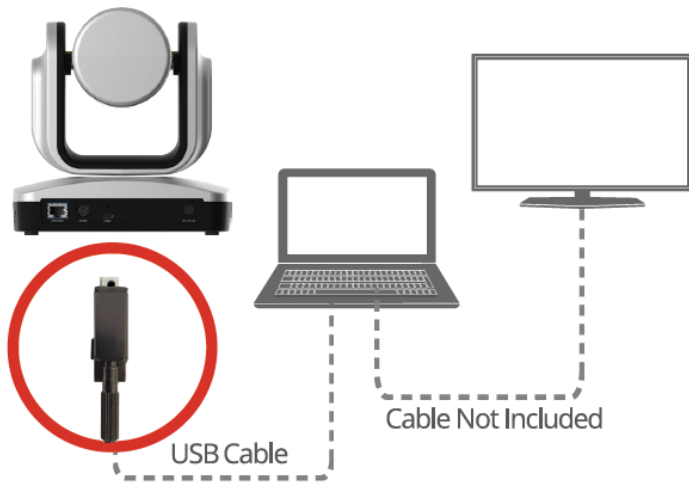

4. Secure the USB cable

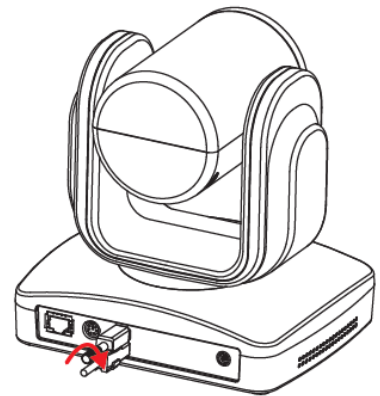

5. Wall mount installation

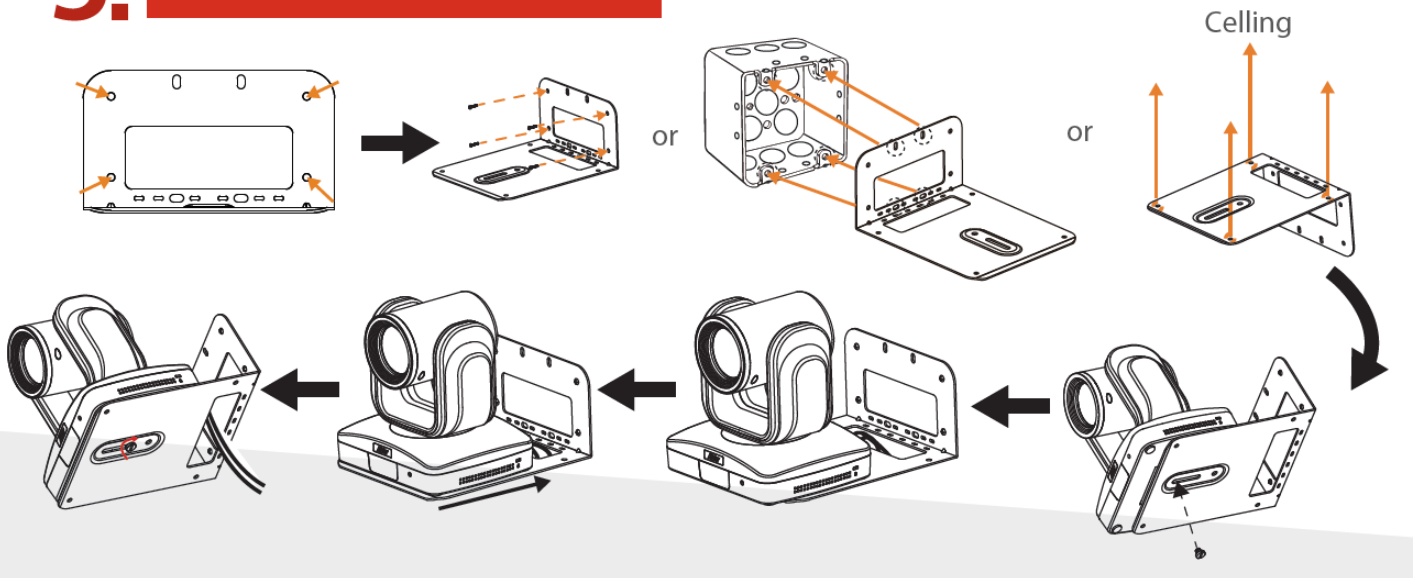

Making a video call

(a computer is required to use this device)

Step 1: Open your Video application (Skype™, Microsoft® Lync™, Google Hangout, Cisco WebEx®, GoToMeeting™, WebRTC and etc.)

Step 2: Set the VC520+ as your primary camera, microphone and speaker devices in your application (please consult your application setup guide for details)

Step 3: Ready to make a video call.

Quick Reference

Camera Preset – The Preset button on the remote serves 2 functions.

To Save a Preset – Move camera to desired position. **Press and HOLD** the preset button until you receive the save message on the screen.

Select **0 – 9** to store the current camera position. Repeat if needed.

To Load a Preset - **TAP** the preset button, select **0 – 9** to **load** a saved camera position. Repeat steps if needed.

Mute / Unmute Speakerphone – Tap the microphone icon on the speakerphone to Mute / Unmute the speakerphone.

RED LED – Microphone is **Muted**

BLUE LED – Microphone is **Unmuted/Active**

Pan / Tilt – To move the camera, point the remote at the camera. Use the directional buttons to guide the camera to the desired position. **IMPORTANT: DO NOT PHYSICALLY MOVE THE CAMERA BY HAND WHEN POWER IS APPLIED. THIS WILL DAMAGE YOUR CAMERA.**

Remote and Speakerphone diagram

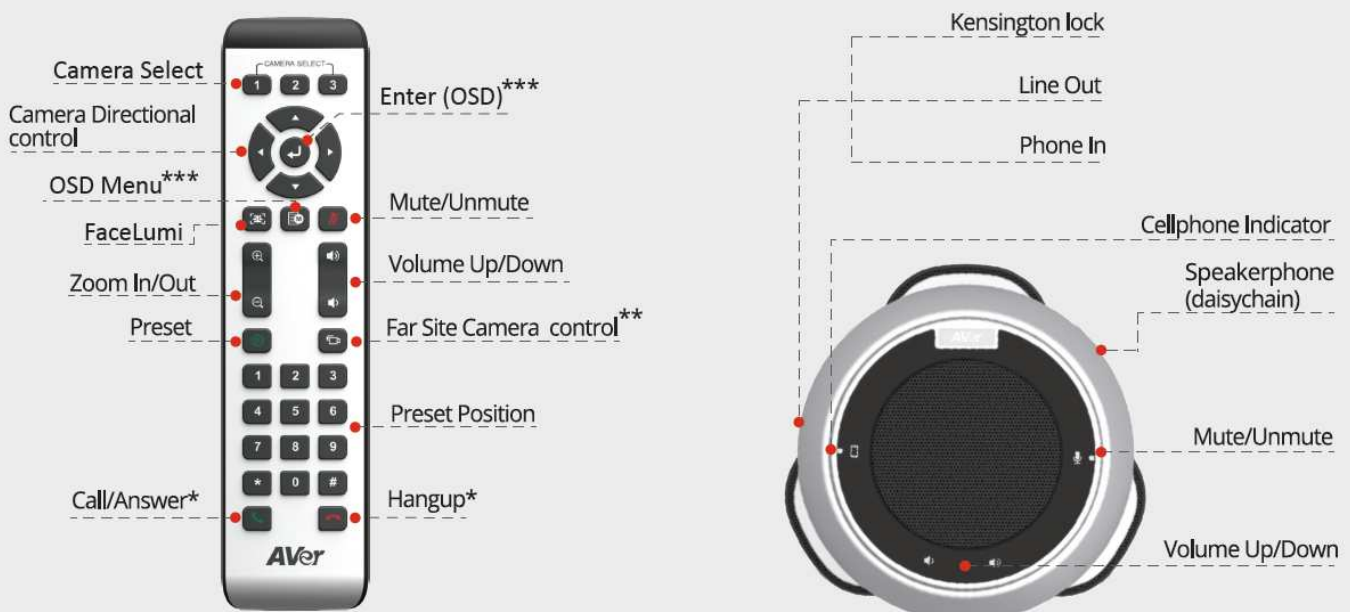

AAA batteries (required)
 *Function requires AVer PTZ App
 **Future Support
 ***Only support on CAM530

Note: The VC520+ is a Plug-n-Play Conference camera. The system requires no special drivers, but we highly recommend installing the AVer PTZ App for the best user experience. Please visit <http://www.aver.com> for more information.

Optional accessories: Daisy-chain speakerphone, 20M speakerphone cable, RS232 adapter

European Community Compliance Statement
 This product is herewith confirmed to comply with the requirements set out in the Council Directives on the Approximation of the laws of the Member States relating to Electromagnetic Compatibility Directive 2014/30/EU.
 Warning - This is a Class A product. In a domestic environment this product may cause radio interference in which case the user may be required to take adequate measures to correct this interference.

VCCI-A この装置は、クラスA機器です。この装置を住宅環境で使用すると電波妨害を引き起こすことがあります。この場合には使用者が適切な対策を講ずるよう要求されることがあります。VCCI-A

警告使用者: 這是甲類的資訊產品，在居住的環境中使用時，可能會造成射頻干擾，在這種情況下，使用者會被要求採取某些適當的對策。

©2017 AVer Information Inc. All rights reserved.
 All rights of this object belong to AVer Information Inc. Reproduced or transmitted in any form or by any means without the prior written permission of AVer Information Inc. is prohibited. All information or specifications are subject to change without prior notice. "AVer" is a trademark owned by AVer Information Inc. Other trademarks used herein for description purpose only belong to each of their companies. P/N:300AV8U2-EAA