

CAM520 Pro

User Manual



Federal Communications Commission Statement



NOTE: This equipment has been tested and found to comply with the limits for a Class A digital device, pursuant to part 15 of the FCC Rules. These limits are designed to provide reasonable protection against harmful interference when the equipment is operated in a commercial environment. This equipment generates, uses, and can radiate radiofrequency energy and, if not installed and used in accordance with the instruction manual, may cause harmful interference to radio communications. Operation of this equipment in a residential area is likely to cause harmful interference in which case the user will be required to correct the interference at his own expense.

FCC Caution: Any changes or modifications not expressly approved by the party responsible for compliance could void the user's authority to operate this equipment.

This device complies with part 15 of the FCC Rules.

Operation is subject to the following two conditions:

- (1) This device may not cause harmful interference, and
- (2) this device must accept any interference received, including interference that may cause undesired operation.

Warning:

This is a class A product. In a domestic environment this product may cause radio interference in which case the user may be required to take adequate measures.

DISCLAIMER

No warranty or representation, either expressed or implied, is made with respect to the contents of this documentation, its quality, performance, merchantability, or fitness for a particular purpose. Information presented in this documentation has been carefully checked for reliability; however, no responsibility is assumed for inaccuracies. The information contained in this documentation is subject to change without notice.

In no event will AVer Information Inc. be liable for direct, indirect, special, incidental, or consequential damages arising out of the use or inability to use this product or documentation, even if advised of the possibility of such damages.

TRADEMARKS

"AVer" is a trademark owned by AVer Information Inc. Other trademarks used herein for description purpose only belong to each of their companies.

COPYRIGHT

©2020 AVer Information Inc. All rights reserved.

All rights of this object belong to AVer Information Inc. Reproduced or transmitted in any form or by any means without the prior written permission of AVer Information Inc. is prohibited. All information or specifications are subject to change without prior notice.

NOTICE

SPECIFICATIONS ARE SUBJECT TO CHANGE WITHOUT PRIOR NOTICE. THE INFORMATION CONTAINED HEREIN IS TO BE CONSIDERED FOR REFERENCE ONLY.

WARNING

- To reduce risk of fire or electric shock, do not expose this appliance to rain or moisture. Warranty will be void if any unauthorized modifications are done to the product.
- Do not drop the camera or subject it to physical shock.
- Use correct power supply voltage to avoid damaging camera.
- Do not place the camera where the cord can be stepped on as this may result in fraying or damage to the lead or the plug.
- Hold the bottom of the camera with both hands to move the camera. Do not grab the lens or lens holder to move the camera.

Remote Control Battery Safety Information

- Store batteries in a cool and dry place.
- Do not throw away used batteries in the trash. Properly dispose of used batteries through specially approved disposal methods.
- Remove the batteries if they are not in use for long periods of time. Battery leakage and corrosion can damage the remote control. Dispose of batteries safely and through approved disposal methods.
- Do not use old batteries with new batteries.
- Do not mix and use different types of batteries: alkaline, standard (carbon-zinc) or rechargeable (nickel-cadmium).
- Do not dispose of batteries in a fire.
- Do not attempt to short-circuit the battery terminals.

Contact Information

Global

AVer Information Inc.

www.aver.com

8F, No.157, Da-An Rd., Tucheng Dist.,

New Taipei City

Taiwan

European Headquarters

AVer Information Europe B.V.

Westblaak 140, 3012KM, Rotterdam, Netherland

Tel: +31(0)10 7600 550

Technical support: EU.RMA@aver.com

Contents

Package Contents	1
Product Introduction	2
Overview	2
DIP Switch	2
Remote Control	3
Pan and Tilt Angle	5
Installation	6
Device Connection	6
Power Connection	7
HDMI Connection	8
RS232 Connection	9
Wall Mount Installation	15
Secure the Cables	18
Operating the Camera	19
Make a Video Call	19
Make a Connection by Aver IP Finder App	19
Use SmartFrame Function	21

What is SmartFrame?	21
Two kinds of SmartFrame Function	21
How does SmartFrame Work.....	22
Web Settings.....	23
Login In	23
Live Screen Operation	24
Setup the Preset	25
Select the Preset Position	27
Camera Settings	28
Smart Frame.....	28
Auto Focus	28
Home Position	29
Sleep Position.....	29
Sleep Timer	29
On Screen Menu	30
Camera Binding.....	30
Image Settings	31
Image Flip.....	31
Image Mirror	31







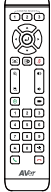

True WDR.....	32
Frequency.....	32
White Balance	33
Noise Reduction	33
Brightness.....	34
Sharpness	34
Saturation	35
RS232 Setting	35
Video Format Setting	36
IP Stream Resolution.....	36
Frame Rate.....	37
Bit Rate.....	37
RTSP.....	38
RTMP	40
Network Setting.....	41
DHCP	41
Static IP	41
System Setting.....	42
Language	42

FW Update	43
Reset Settings	44
Camera Reboot	45
Change Password	46
SSL Certificate.....	47
Date Format.....	48
Time Format	49
Time Correction Mode	50
Information.....	50
Using AVer PTZApp	51
Install AVer PTZApp	51
Using AVer PTZApp	51
Set the Camera Number.....	58
Hotkey Control.....	59
Reset Password	60
Home / Sleep Position	61
ADDR / Protocol/Baud Rate	61
OpenGL.....	62
OSD Setup.....	63

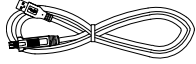
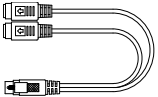
Camera Settings	64
Smart Frame.....	64
WDR.....	64
Image Flip.....	65
Image Mirror	65
Allow Remote Access	66
Advanced Setting.....	67
Auto Focus	67
Home position.....	67
Sleep position	68
On Screen Menu	68
Frequency.....	69
White Balance	69
Noise Reduction	70
Brightness.....	70
Sharpness	71
Saturation	71
RS232 Setting	72
HDMI Video Format	72

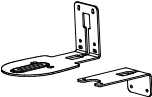
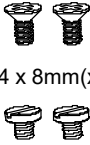
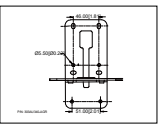
Network.....	73
DHCP	73
Static IP	73
System Setting.....	74
Language	74
Factory Default	75
Change Password	75
Information.....	76
Install EZLive.....	77
Use AVer EZLive	77

Package Contents

Camera Unit¹	Remote Control	Power Adapter Power Plug²	USB 3.0 Cable																																																
																																																			
RS232 Cable* (mini DIN 9 to mini DIN8)	HDMI Cable*	L-Mount Bracket	Screws for Mount																																																
			 <p>M4 x 8mm(x2) 1/4"-20 L=7.5mm(x2)</p>																																																
Drilling Paper	Quick Guide	Warranty Card	DIP Switch Sticker*																																																
			 <p>The table below is for HDMI output resolution combination. Please refer to it while using DipSwitch on the rear panel of camera.</p> <table border="1"> <tr> <td>1</td><td>2</td><td>3</td><td>4</td><td>5</td><td>6</td><td>7</td><td>8</td><td>9</td><td>10</td><td>11</td><td>12</td><td>13</td><td>14</td><td>15</td><td>16</td> </tr> <tr> <td>1080i</td><td>1080p</td><td>720p</td><td>720i</td><td>480p</td><td>480i</td><td>360p</td><td>360i</td><td>288p</td><td>288i</td><td>216p</td><td>216i</td><td>144p</td><td>144i</td><td>72p</td><td>72i</td> </tr> <tr> <td>1080p</td><td>1080i</td><td>720p</td><td>720i</td><td>480p</td><td>480i</td><td>360p</td><td>360i</td><td>288p</td><td>288i</td><td>216p</td><td>216i</td><td>144p</td><td>144i</td><td>72p</td><td>72i</td> </tr> </table>	1	2	3	4	5	6	7	8	9	10	11	12	13	14	15	16	1080i	1080p	720p	720i	480p	480i	360p	360i	288p	288i	216p	216i	144p	144i	72p	72i	1080p	1080i	720p	720i	480p	480i	360p	360i	288p	288i	216p	216i	144p	144i	72p	72i
1	2	3	4	5	6	7	8	9	10	11	12	13	14	15	16																																				
1080i	1080p	720p	720i	480p	480i	360p	360i	288p	288i	216p	216i	144p	144i	72p	72i																																				
1080p	1080i	720p	720i	480p	480i	360p	360i	288p	288i	216p	216i	144p	144i	72p	72i																																				

- 1: There are two SKUs: CAM520 Pro, CAM520 Pro(PoE). CAM520 Pro(PoE) SKU supports HDMI port, DIP switch and PoE+ function.
 - 2: The power plug will vary depending on the standard power outlet of the country where it is sold.
- * Included with CAM520 Pro(PoE) SKU

Optional Accessories

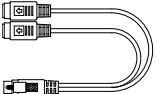
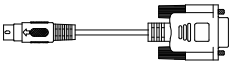
RS232 Cable (MINI DIN 9 to MINI DIN 8)	RS232 Cable (MINI DIN 8 to D-Sub9)
	

Product Introduction

Overview

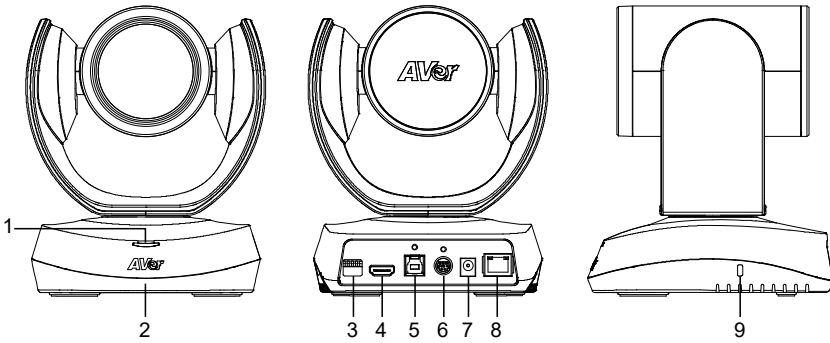

- | | | | | | |
|---|-------------------------|---|------------------------|---|----------------------------|
| 1 | Status LED | 4 | HDMI port ¹ | 7 | DC 12V power plug |
| 2 | IR sensor | 5 | USB3.1 Type B port | 8 | Ethernet port ² |
| 3 | DIP switch ¹ | 6 | RS232 in/out port | 9 | Kensington Lock |

- 1: Only supports for CAM520 Pro(PoE) SKU.
- 2: CAM520 Pro supports LAN. CAM520 Pro(PoE) SKU supports PoE+(IEEE 802.3AT).

DIP Switch

[Only supports CAM520 Pro(PoE) SKU]

The diagram below shows the DIP Switch configurations which can be used to adjust the camera resolution setting.

After adjusting the resolution via DIP switch, users will be unable to adjust the resolution setup from OSD menu using the remote control.

The table below is for HDMI output resolution combination. Please refer to it while using DIP switch on the rear panel of camera.

1 2 3 4	1 2 3 4	1 2 3 4	1 2 3 4	1 2 3 4	1 2 3 4	1 2 3 4	1 2 3 4
Auto	1080P/60	1080P/30	—	—	720P/60	720P/30	480P/60

Remote Control

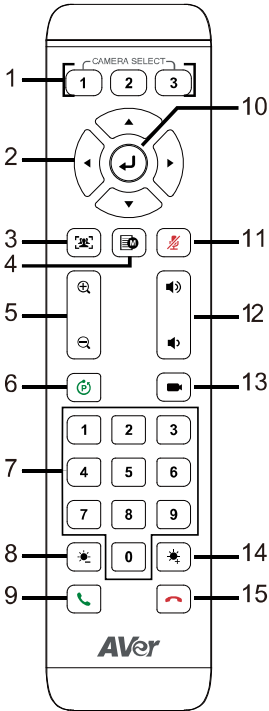

Name	Function
1. Camera select	<p>One remote can control up to 3 AVer VC/CAM/VB series cameras. You can use AVer PTZApp to set numbers associated with each camera, and then select which camera you would like to control using the remote.</p> <p>[Note] If you only have one camera that requires no additional setting, the default is camera 1.</p> <p>If camera 2 or 3 is selected, the remote will be unable to control the camera. In this case, please press camera 1 on your remote.</p>
2. Camera directional control	<p>Use the directional buttons on the remote to control the direction of the camera. Press the directional button to move the camera or press and hold to continuously pan or tilt.</p>
3. SmartFrame	<p>One-click automatic FOV adjustment to fit all participants.</p> <p>Press and hold  on the remote for 2 seconds to switch the SmartFraming function between auto and manual mode; a message (as figure shown) will display on the screen to indicate auto or manual mode.</p> <div style="display: flex; justify-content: space-around;"> <div style="background-color: black; color: white; padding: 5px; border: 1px solid black;">Auto Framing</div> <div style="background-color: black; color: white; padding: 5px; border: 1px solid black;">Manual Framing</div> </div> <p>[Note] While in the video conference meeting, participants must face the camera for proper face detection (SmartFrame). Side facial profiles are not detectable.</p>
4. OSD menu	<p>To call out OSD menu. Only supports CAM520 Pro(PoE) SKU while connecting HDMI output to TV monitor.</p>

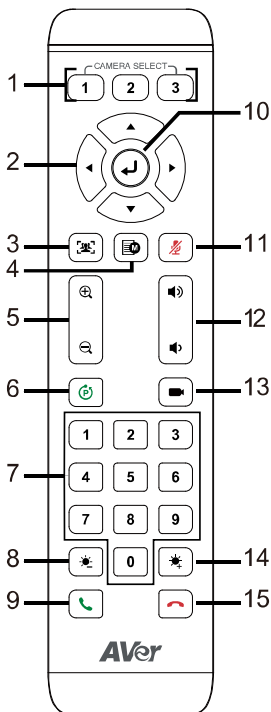

* Function requires AVer PTZApp

** Not supported for CAM520 Pro and CAM520 Pro(PoE)

Name	Function
5. Zoom in/Zoom out	Increase/Decrease the camera zoom.
6. Preset	<ol style="list-style-type: none"> To save the camera at the desired position, press and hold the preset button until the "saved message" is displayed on the PTZApp video screen or other video apps. Select preset position button 0 to 9 to save. Press "preset" + "preset position button" (0~9) to move the camera to the saved position.
7. Preset position/Number buttons	<p>Preset position buttons are used in conjunction with the Preset button to save positions. There are a total of 10 presets.</p> <p>Press the preset button first and then press 0~9 for the camera to move to the saved position.</p> <p>[Note]</p> <ul style="list-style-type: none"> Press and hold the number button "1" to turn the WDR function on or off. To turn off SmartFrame function, Press and hold number button "5" for one second to switch the function off or on.
8. Brightness -	Decrease the brightness.
9. Call/answer*	Answer a call or start a call.
10. Enter**	To confirm selection.
11. Mute/Unmute Speakerphone**	Mute/Unmute the speakerphone.
12. Volume up/down**	Adjust volume up or down.
13. Preset hot key	Press to move the camera to the preset position the user has set.
14. Brightness +	Increase the brightness.
15. Hang up*	End the call.

Pan and Tilt Angle

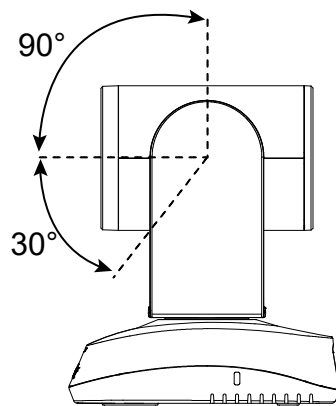
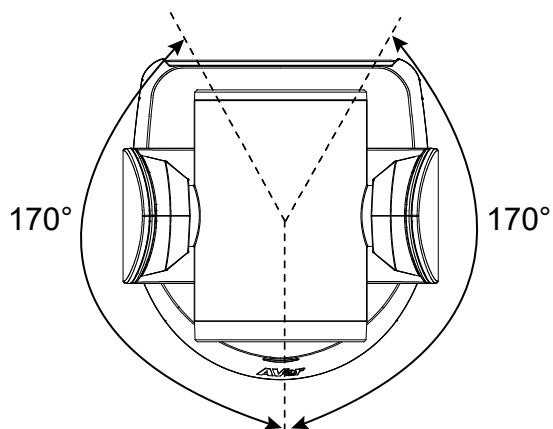

Installation

Device Connection

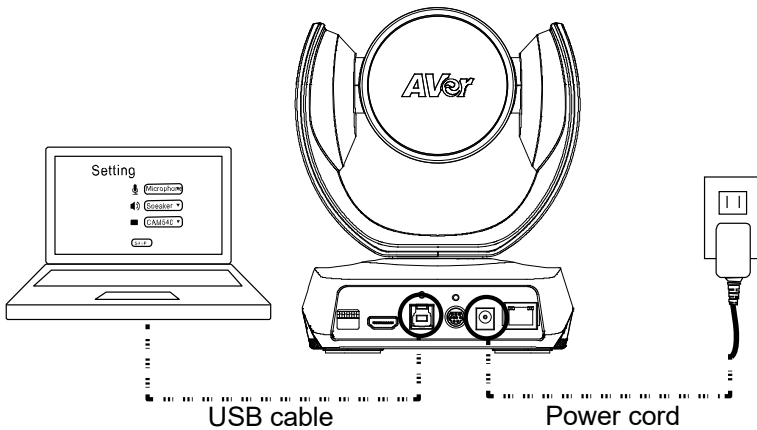

1. Use USB cable to connect the CAM520 Pro to your PC/laptop (refer to diagram above).
2. Connect the power to the CAM520 Pro; power indicator will light up and camera head will rotate.
3. Install AVer PTZApp on laptop or PC that is connected with CAM520 Pro. The app can be used to adjust and setup the parameters of the camera (refer to the section of AVer PTZApp)
4. To make a call, run your video application (Zoom, Microsoft[®] Teams, Skype for Business, Skype, Google Hangouts, Intel[®] Unite™, RingCentral, BlueJeans, V-Cube, LiveOn, CyberLink U Meeting[®], TrueConf, Adobe Connect, Cisco WebEx[®], Fuze, GoToMeeting™, Microsoft[®] Lync™, Vidyo, vMix, WebRTC, Wirecast, XSplit.... etc.) select CAM520 Pro as your video device.

Power Connection

The power supply can be plugged into the wall outlet or drawn from PoE+ switch (Ethernet).
[PoE+ is only supported for CAM520 Pro (PoE) SKU.]

Wall outlet

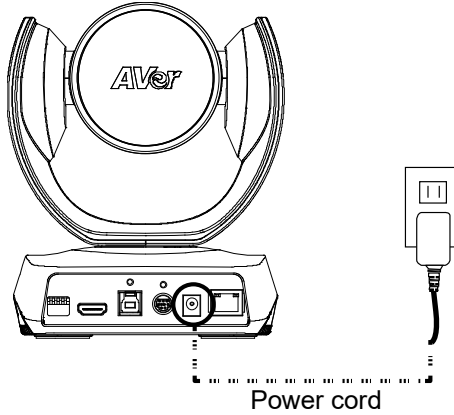

PoE+

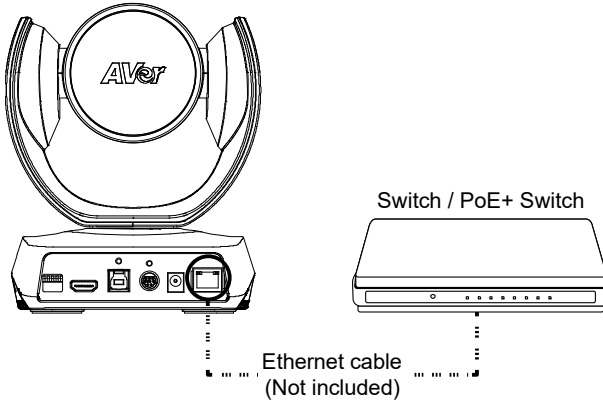

[Note]

- a. To ensure stability of IP video streaming, please use CAT 5e FTP cable (not included).
- b. For PoE switch hub, it's recommended to use Gigabit PoE switch to ensure stable power supply.

HDMI Connection

[HDMI connection is only supported for CAM520 Pro(PoE) SKU.]

Connect with TV or monitor through the HDMI port to display camera video on the screen.

Press  button on remote control to call out the OSD menu to configure the parameters of the camera. For OSD setting refer to **OSD operation** section.

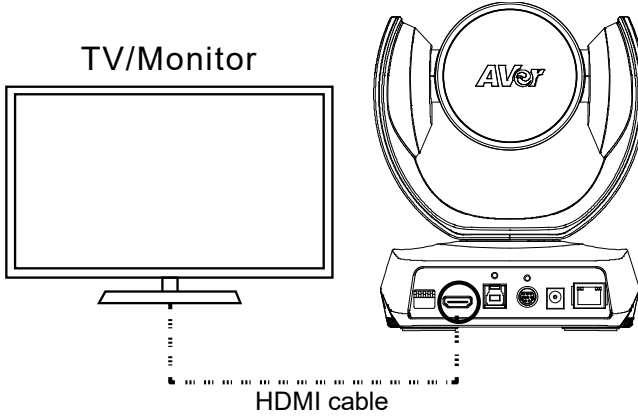

RS232 Connection

■ Camera RS232 Port Pin Definition

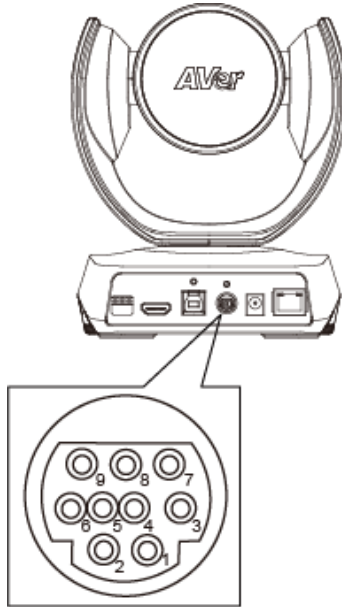

Function	Mini DIN9 PIN #	I/O Type	Signal	Description
VISCA IN	1	Output	DTR	Data Terminal Ready
	2	Input	DSR	Data Set Ready
	3	Output	TXD	Transmit Data
	6	Input	RXD	Receiver Data
VISCA OUT	7	Output	DTR	Data Terminal Ready
	4	Input	DSR	Data Set Ready
	8	Output	TXD	Transmit Data
	9	Input	RXD	Receiver Data
	5	---	---	---

■ Computer/Keyboard Controller and Camera Connection

Direct Connection

If users don't buy AVer RS232 adaptor cable, please refer to the pin connection shown below.

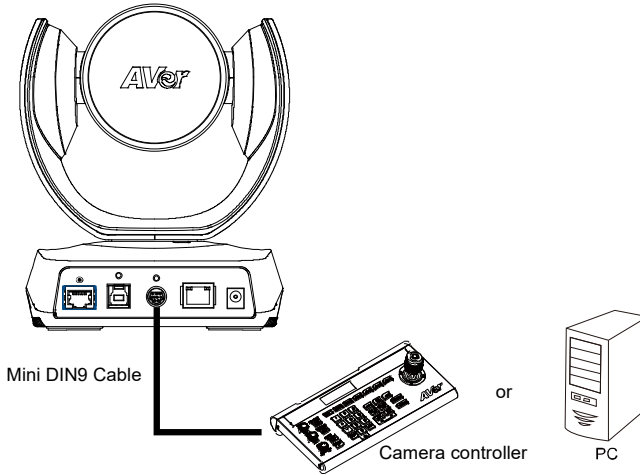

Camera (Mini DIN9)	Controller/PC (DB9)
1. DTR(IN)	1. DCD
2. DSR(IN)	2. RXD
3. TXD(IN)	3. TXD
6. RXD(IN)	4. DTR
7. DTR(OUT)	5. GND
4. DSR(OUT)	6. DSR
8. TXD(OUT)	7. RTS
9. RXD(OUT)	8. CTX
	9. RI

Use the RS232 mini DIN9 to mini DIN8 cable (included with CAM520 Pro(PoE) SKU, otherwise sold separately).

Users can purchase AVer RS232 min DIN9 to mini DIN8 adaptor cable* to connect with Computer or keyboard/controller.

1. RS232 (mini DIN9 to mini DIN8) adaptor cable (PN: 064AOTHERCDC)

2. Users can also purchase a miniDIN8 to D-Sub9 cable to connect with camera controller.
(PN: 064AOTHERBPK)

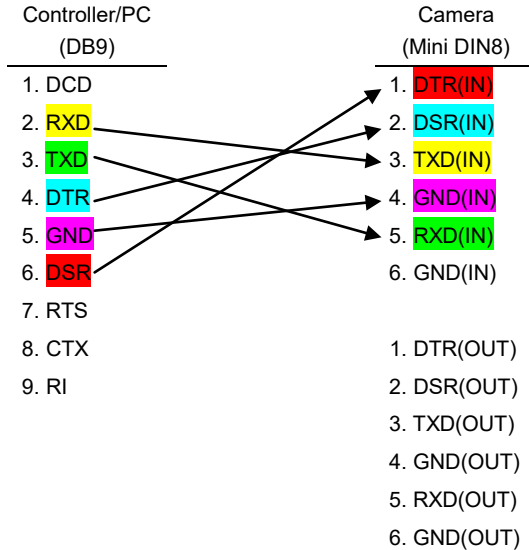
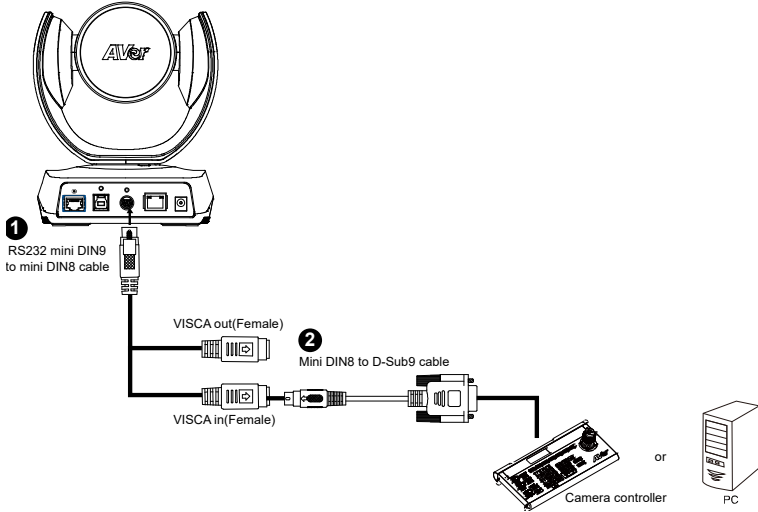

■ RS232 mini DIN9 to mini DIN8 Cable Pin Definition

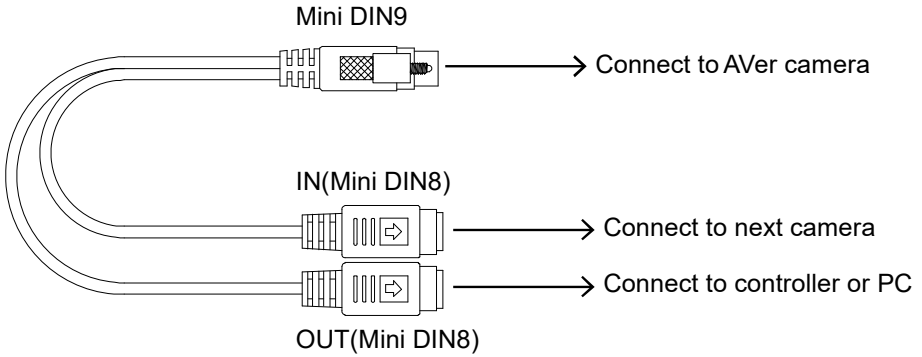

Mini DIN8 Pin Definition

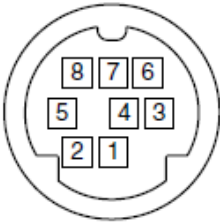

No.	Pin
1	DTR
2	DSR
3	TXD
4	GND
5	RXD
6	GND
7	NC
8	NC

■ Camera Cascade Connection

Direct Connection

If users don't buy AVer RS232 adaptor cable, please refer to the pin connection shown below for cascading cameras.

Total can connect up to 7 cameras.

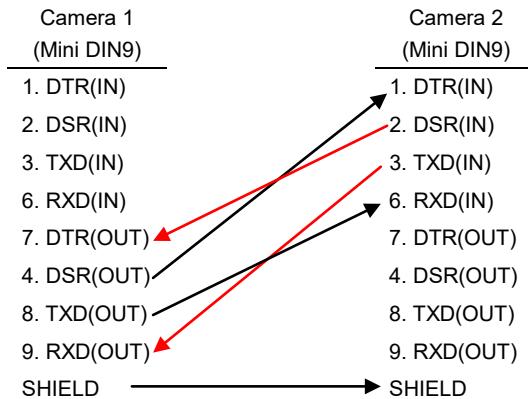
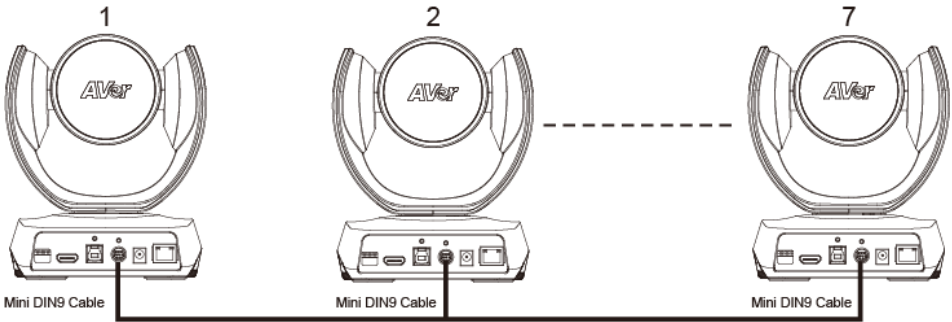

Use the RS232 mini DIN9 to mini DIN8 cable

Total can connect up to 7 cameras.

To facilitate the camera cascade, users can purchase AVer RS232 adaptor cable.

Connect camera with AVer mini DIN9 to mini DIN8 adaptor cable. Connect the mini DIN8 female side to male mini DIN8 Visca cable (Users have to buy it in the market) and then connect AVer mini DIN9 to mini DIN8 adaptor cable again to connect to next camera.

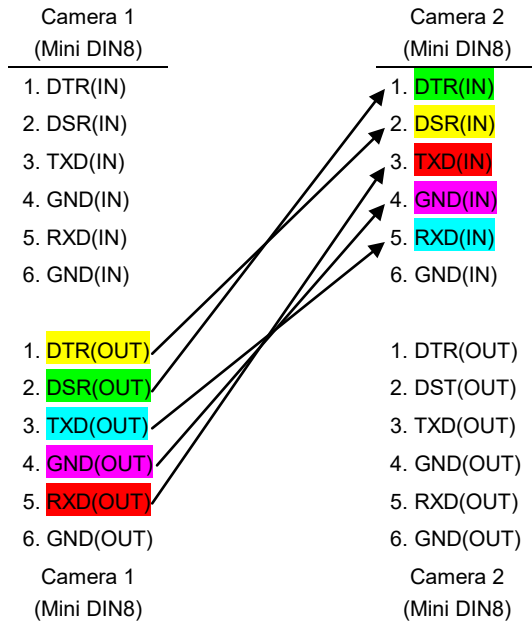
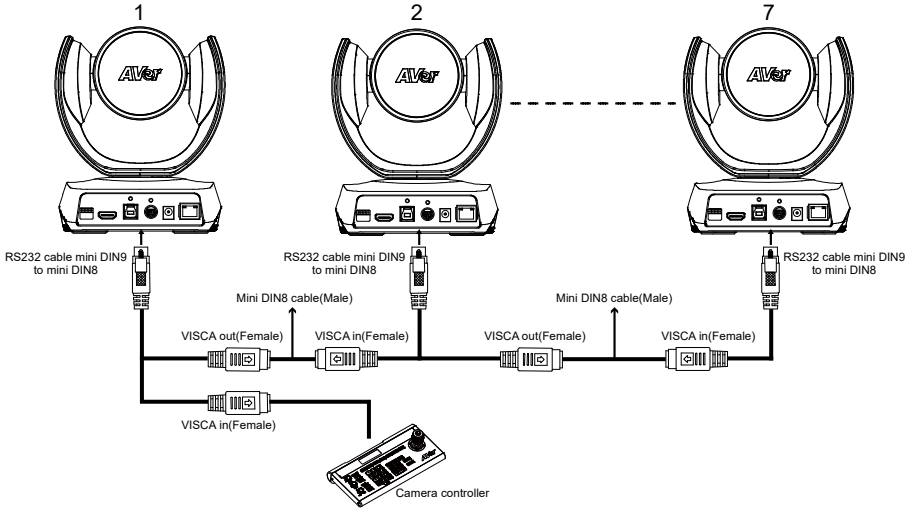

Wall Mount Installation

1. Use the drilling paper included in the package to drill the holes in the wall where the user wants to mount the camera.

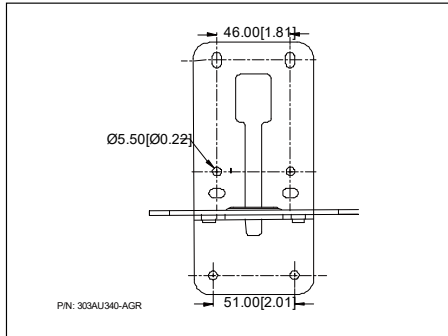

2. Use the screw to secure the **A** L-mount bracket on the wall.

Screw

- For **Cement wall**: M4 x20mm self-tapping screws(x4) + Plastic conical anchor
- For **Wooden wall**: M4 x20mm self-tapping screws(x4)

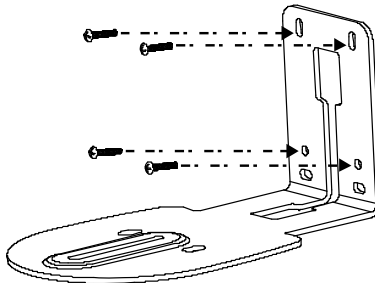

3. Then, assemble the [A] + [B] L-mount bracket with screws (included in package).

Screw:  M4 x 8mm(x2)

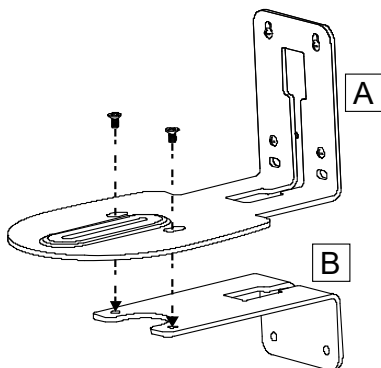

4. After assembling the L-mount bracket, secure the lower part of L-mount bracket on the wall.

Screw

- **For Cement wall:** M4 x20mm self-tapping screws(x2) + Plastic conical anchor
- **For Wooden wall:** M4 x20mm self-tapping screws(x2)

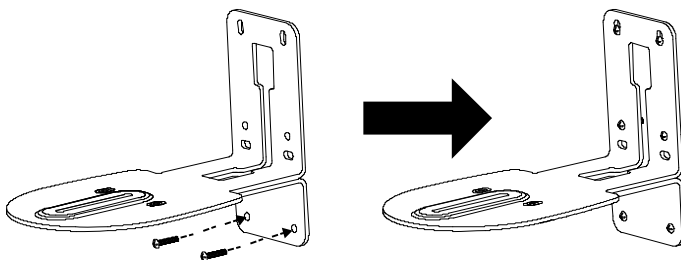

5. Pass the cables through the hole on the L-mount bracket and connect the cables to corresponding connection ports.

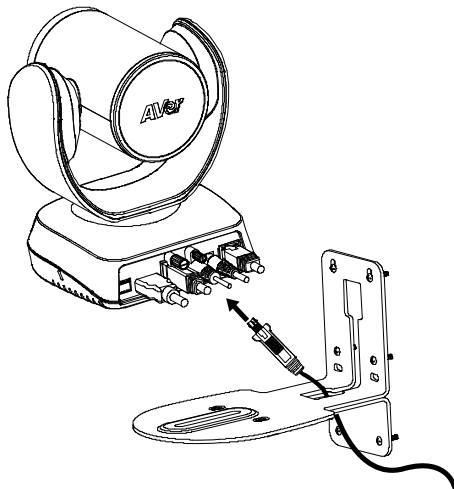

6. Use the remaining screws (included in package) to secure the camera on the L-mount bracket.

Screw:  1/4"-20 L=7.5mm(x2)

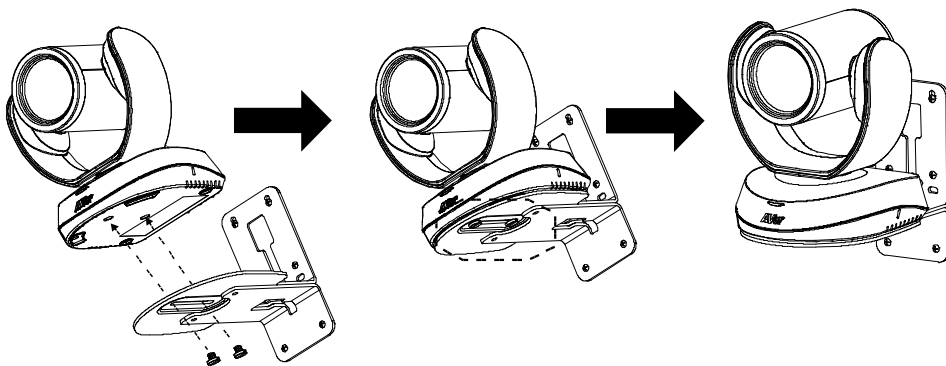

Secure the Cables

For USB and RS232 cable, the cables have a screw on the cable for fixing cable on the camera.

Install the cable first and secure the cable.

[Note] Make sure the cable is well connected to the connector on the camera before securing the cable.

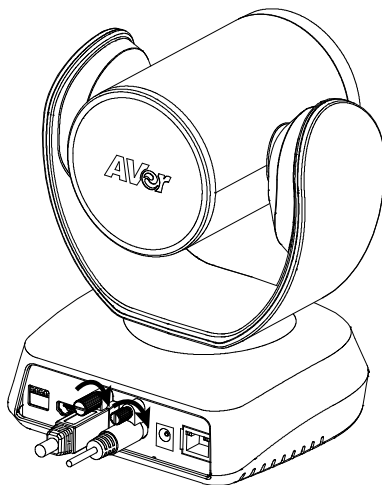

Operating the Camera

Make a Video Call

1. Make sure CAM520 Pro and PC/laptop are well connected and power is on.
2. Run your video application (Zoom, Microsoft® Teams, Skype for Business, Skype, Google Hangouts, Intel® Unite™, RingCentral, BlueJeans, V-Cube, LiveOn, CyberLink U Meeting®, TrueConf, Adobe Connect, Cisco WebEx®, Fuze, GoToMeeting™, Microsoft® Lync™, Vidyo, vMix, WebRTC, Wirecast, XSplit....etc.) on your PC or laptop.
3. Set the CAM520 Pro camera as the primary camera for your video application (refer to your video application user guide). You can now make your call.
4. The CAM520 Pro is a plug-and-play conference camera. The system requires no special drivers, but we do recommend installing the AVer PTZApp for a better user experience. For information on how to install and use the AVer PTZApp, refer to the AVer PTZApp section in this user manual.

Make a Connection by AVer IP Finder App

CAM520 Pro supports Ethernet connection; user can use AVer IP Finder app to find the camera and make a connection through the browser to configure the camera.

1. Download the IP Finder from <http://www.aver.com/download-center>.
2. Run the IP Finder.
3. Click **“Search”**, and all available devices will be listed on the screen.

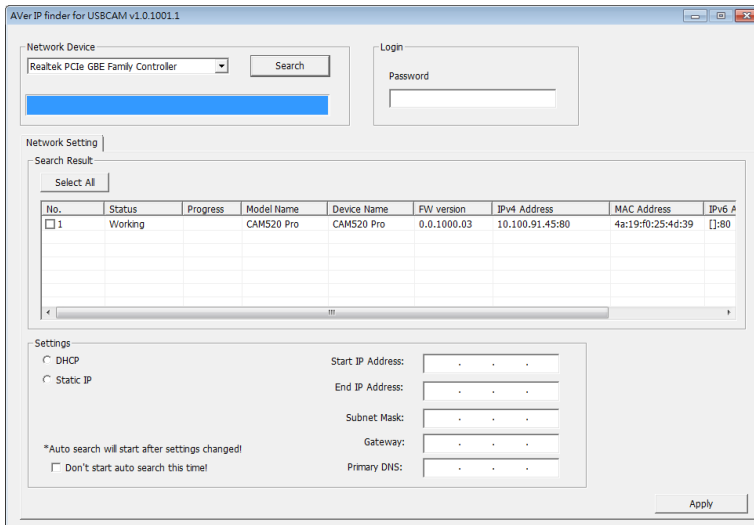

4. Select a camera from the list. The corresponding fields of IP address will display.
5. To change the IP address of camera, user can select “**DHCP**” or “**Static IP**”.
The DHCP should get the IP address from local dynamic IP sever. The static IP, user can enter the specific IP address. Click “**Apply**” to apply the setting to the camera. The password is required (default password is **aver4321**).
6. Click “**Search**” button to re-scan the camera.
7. Double-click on the IP address of camera from the list can connect to camera through the browser.
8. Enter the default password (**aver4321**) to login to Web setup screen.

[Note] If IP Finder cannot find the camera, please check following:

- Please make sure the Ethernet connection of camera is well connected.
- The camera and PC (IP Finder) are in the same LAN segment.

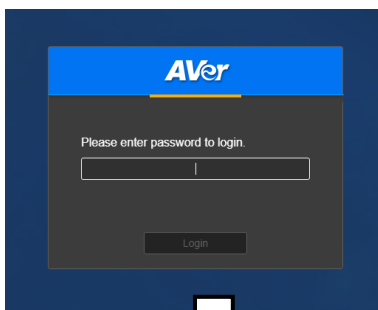

Use SmartFrame Function



What is SmartFrame?

SmartFrame uses face detection technology. While in a conferencing meeting, participants must face the camera for face detection. Side face (one ear/ one eye) is not detectable.

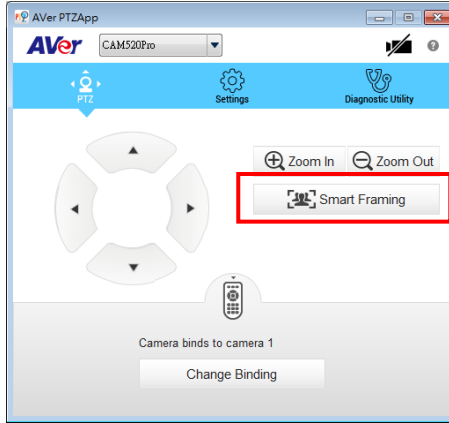
The effective distance to get best performance is at maximum 4.5meters



Two kinds of SmartFrame Function

- **Manual frame:** Once all participants are seated, press  on the remote or use PTZApp to activate it.
- **Auto frame:** Press  for 1 second to switch from manual to Auto framing or use PTZApp and change the setting to Auto frame. You can see **Auto Framing** shown on the bottom of the image screen.

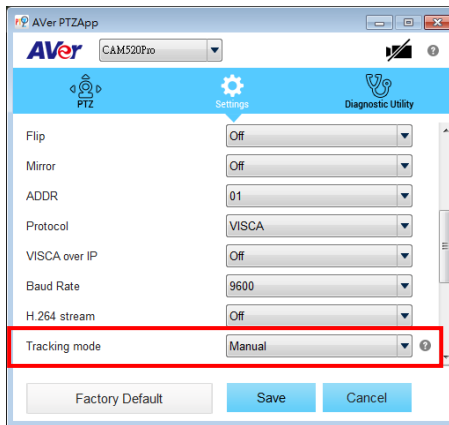

How does SmartFrame Work

- **Manual frame:** Press and hold down the  button and **Framing** will pop up on the top left corner of the Image screen. This indicates for all participating users to sit facing towards the camera to allow it to detect all faces present. After 3 to 5 seconds, the camera will calibrate and automatically zoom to include all users to fit in the screen.
- **Auto frame:** When switching to auto framing mode for the first time, you will see **Framing** pop-up on the top left corner of the Image screen. The camera will begin detecting participants and include everyone in the screen. Once all the participants are in frame, the camera will keep the image stable by not completing any action until subjects move in or out of the screen. When people touch the sides of the screen, it will trigger the camera and automatically switch to wide view mode to detect and frame all the participants again.

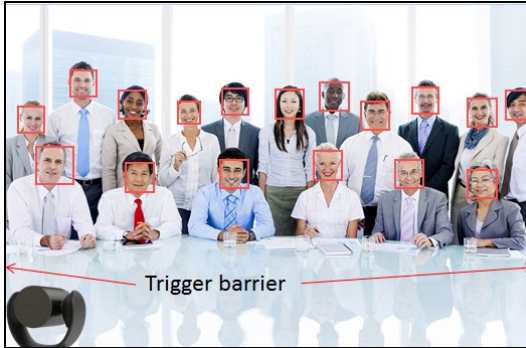

You will see **Framing** message each time the framing function is triggered.

[Note]

- a. If you wish to remove the **Framing** message, please go to the PTZApp and change the “On Screen Menu” setting to OFF.
- b. To switch SmartFrame function, press and hold number  button on the remote to switch on/off. You can also adjust the Tracking mode setting to turn SmartFrame on/off on the PTZApp.

Web Settings

CAM520 Pro has an Ethernet port for IP streaming and allows administrators to remotely control and set up the camera via an internet access.

Login In

To find the IP address of the camera; please refer to “**Make a connection by AVer IP Finder App**” section.

1. Open the browser on your laptop/PC and enter the IP address of the camera.
2. Enter the password at login screen. The default password is “**aver4321**”.
3. The main web screen is displayed.



Live Screen Operation

User can control the camera direction, zoom in/out, and preset selection.

[Note] The system will force the first login to log out when there is a second login.

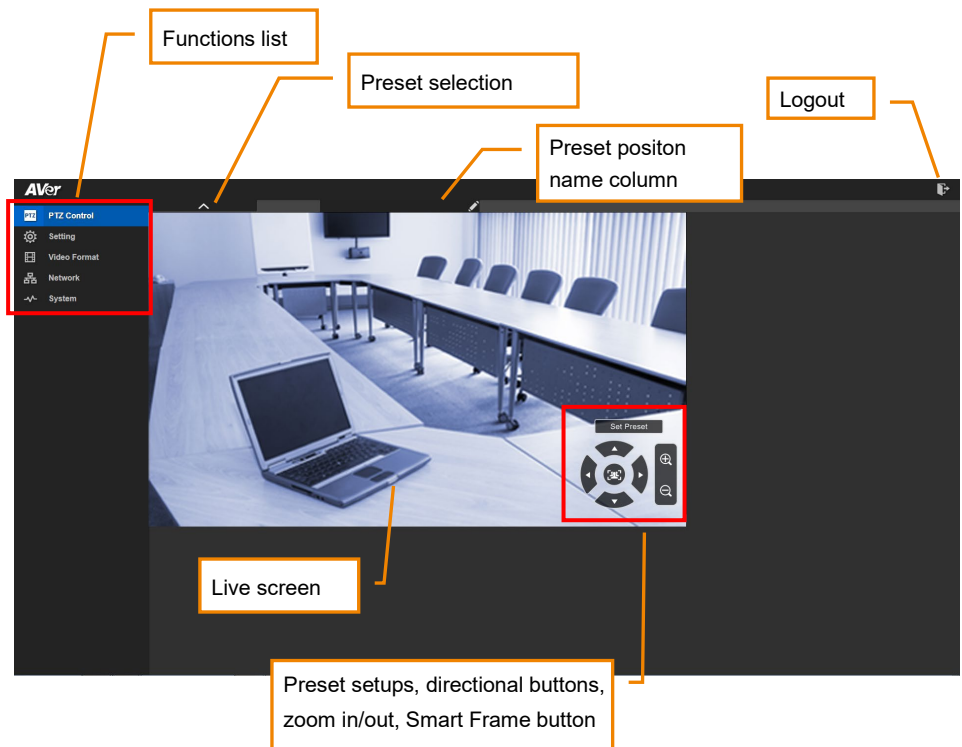

Setup the Preset

User can set 10 preset positions.

1. In live screen, select  to expand preset position list.
2. Select the preset number frame(0~9).
3. Use ▲, ▼, ◀, ▶ and zoom in/out button adjust the camera screen view to desired position.
4. Select **“Set Preset”** button to save the preset. The system will capture the preset screen view and display in preset number frame.

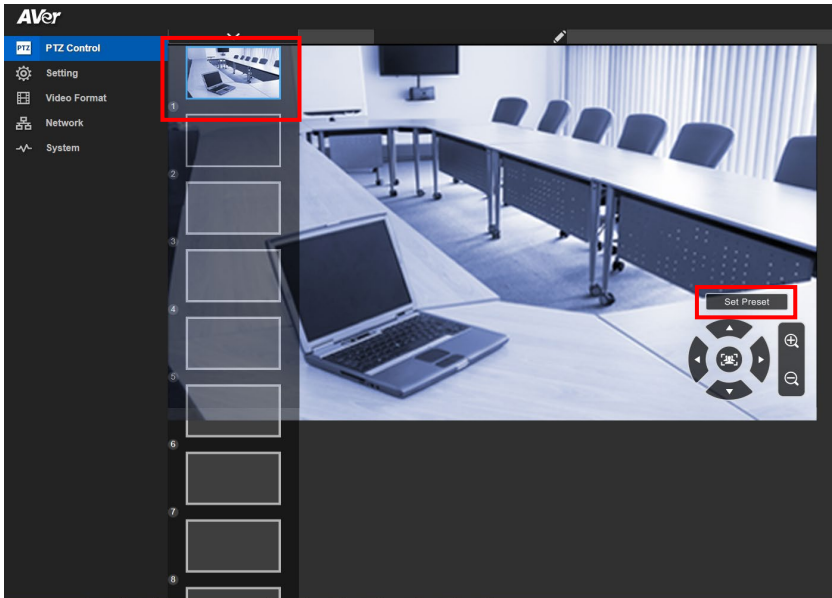

5. User can setup name of preset position. Select pencil icon and enter the name. To delete the name, select pencil icon and use delete key on keyboard to delete it.

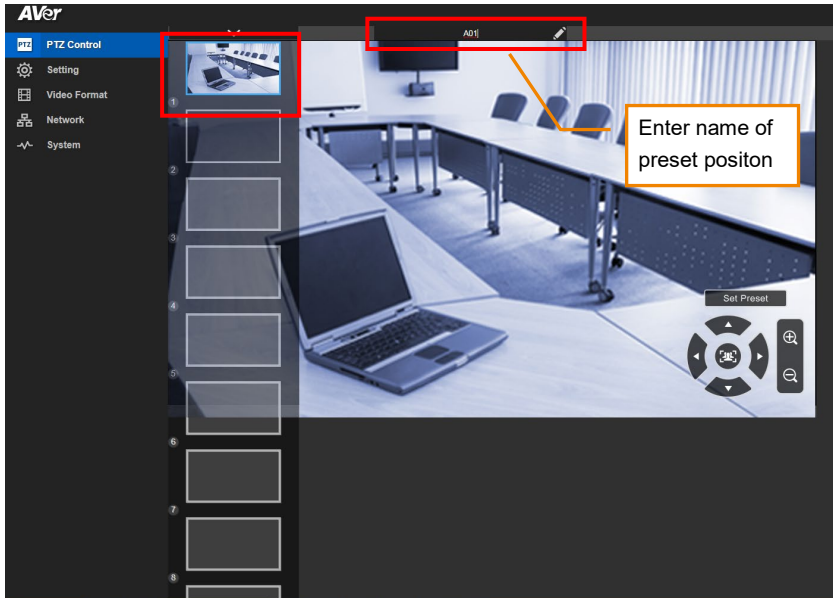

6. To set another preset, repeat the above steps.

Select the Preset Position

Preset positions need to be set.

Select  to expand the preset position list and select the preset user wants. The live screen will move the preset screen view. Use mouse to scroll up or down to select the preset.

Select  to close the preset position list.

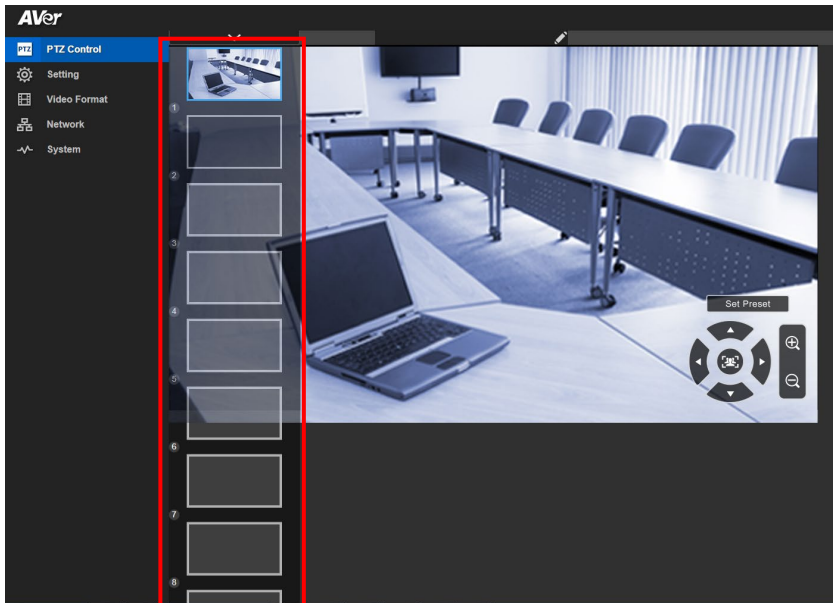

Camera Settings

Smart Frame

One-click automatic FOV (field of view) adjustment to fit all participants.

In live screen view, select **“Setting”** > **“Camera”** > **“Smart Frame”** > **“Auto”**, **“Manual”** or **“Off”**.

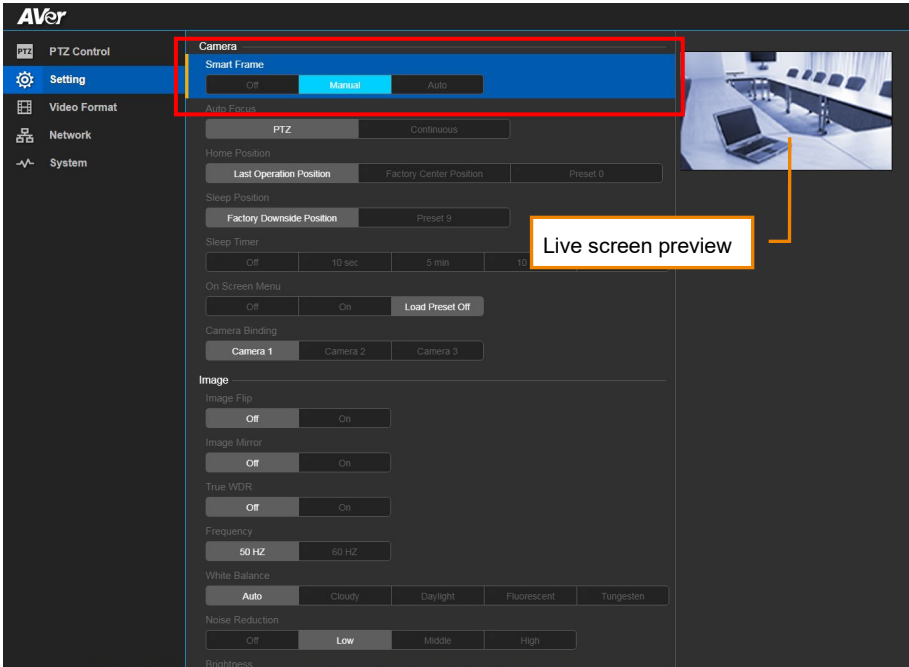

Auto Focus

Set auto focus mode.

In live screen view, select **“Setting”** > **“Camera”** > **“Auto Focus”** > **“PTZ”** or **“Continuous”**.

- **PTZ:** By clicking the button(such as pan, tilt, zoom in/out) to adjust focus once.
- **Continuous:** The camera will adjust the focus when the objects have moved.

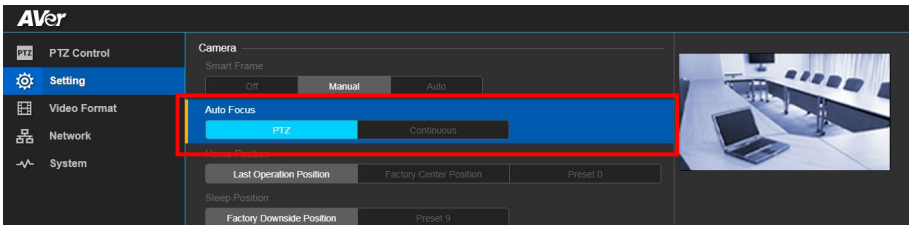

Home Position

Set the home position for camera to return.

In live screen view, select **“Setting”** > **“Camera”** > **“Home Position”** > **“Last operating position”**, **“Factory Central Position”** or **“Preset 0”**.

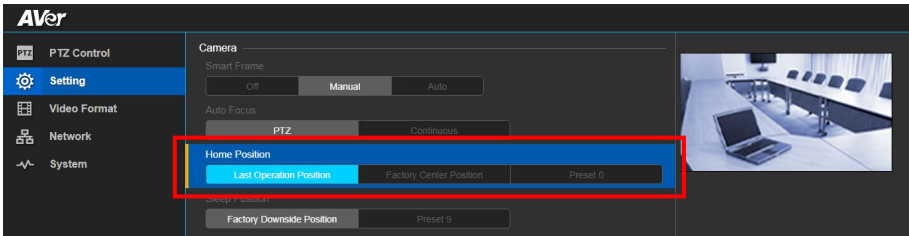

Sleep Position

When the camera idles for more than 3 minutes, it will enter sleep mode.

In live screen view, select **“Setting”** > **“Camera”** > **“Sleep Position”** > **“Factory Central Position”** or **“Preset 9”**.

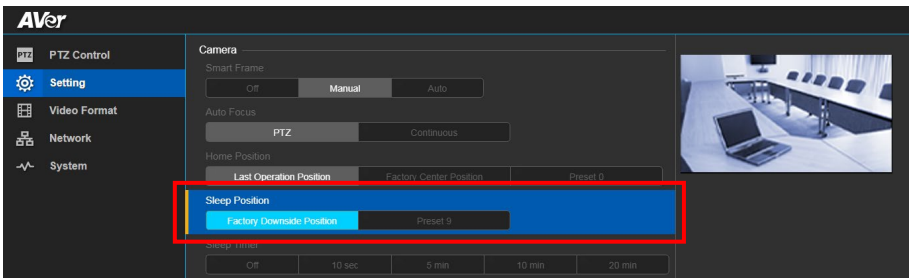

Sleep Timer

Set the camera idle time to enter sleep mode.

In live screen view, select **“Setting”** > **“Camera”** > **“Sleep Timer”** > **“Off”**, **“10sec”**, **“5min”**, **“10min”** or **“20min”**.

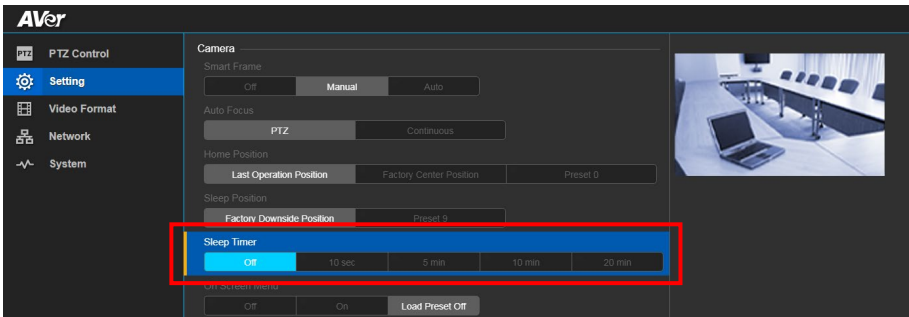

On Screen Menu

Enable/disable on screen display status information.

In live screen view, select **“Setting”** > **“Camera”** > **“On Screen Menu”** > **“Off”**, **“On”** or **“Load Preset Off”**.

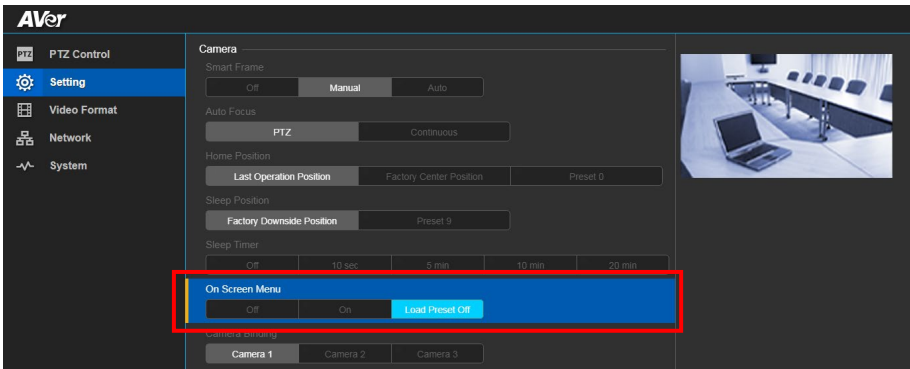

Camera Binding

With multiple cameras connection, users can set each camera to buttons 1 to 3 on the remote control.

In live screen view, select **“Setting”** > **“Camera”** > **“Camera Binding”** > **“Camera 1”**, **“Camera 2”** or **“Camera 3”**.

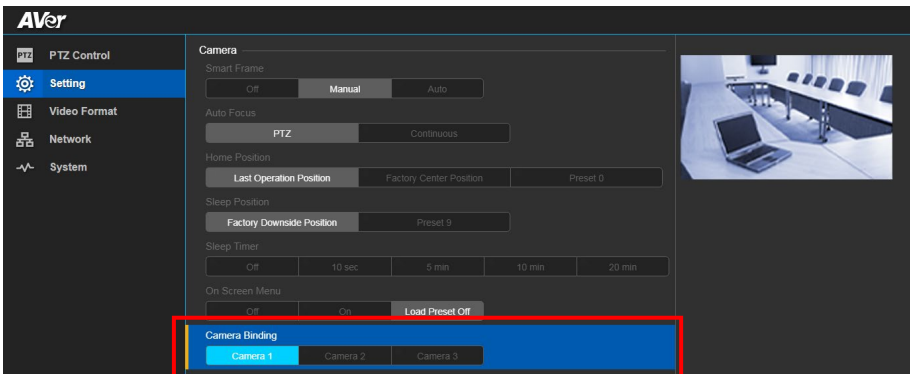

Image Settings

Image Flip

If the CAM520 Pro is installed in the upside down position, please enable the "Flip".
In live screen view, select **"Setting" > "Image" > "Image Flip" > "Off"**, or **"On"**.

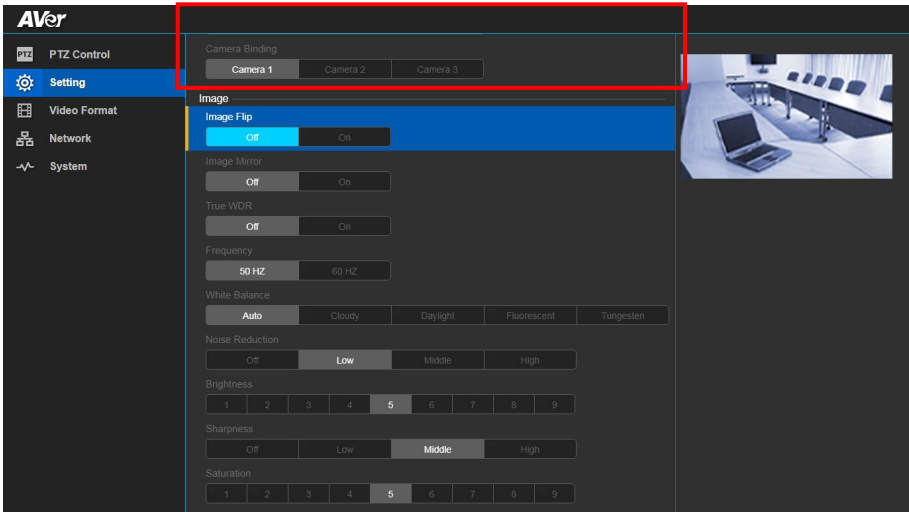
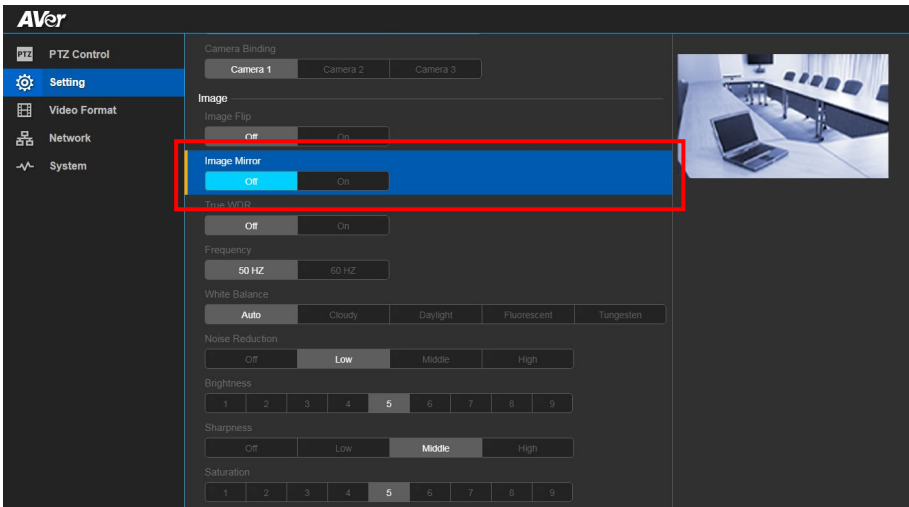

Image Mirror

To mirror the camera image.
In live screen view, select **"Setting" > "Image" > "Image Mirror" > "Off"** or **"On"**.



True WDR

In back light environment, enable WDR to improve the brightness of image.

In live screen view, select **“Setting”** > **“Image”** > **“True WDR”** > **“Off”** or **“On”**.

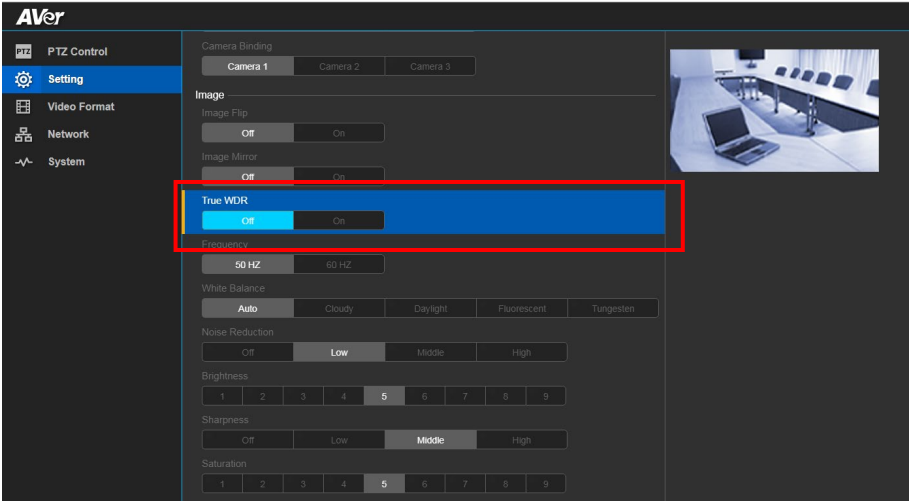

Frequency

Select the frequency of the camera.

In live screen view, select **“Setting”** > **“Image”** > **“Frequency”** > **“50Hz”** or **“60Hz”**.

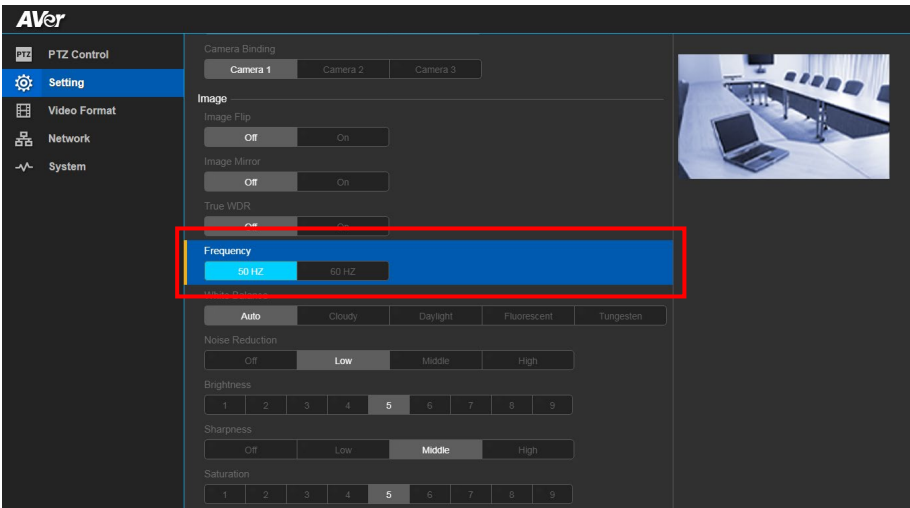

White Balance

Select the White Balance setting for various light conditions or color temperature.

In live screen view, select **"Setting"** > **"Image"** > **"White Balance"** > **"Auto"**, **"Cloudy"**, **"Daylight"**, **"Fluorescent"** or **"Tungsten"**.

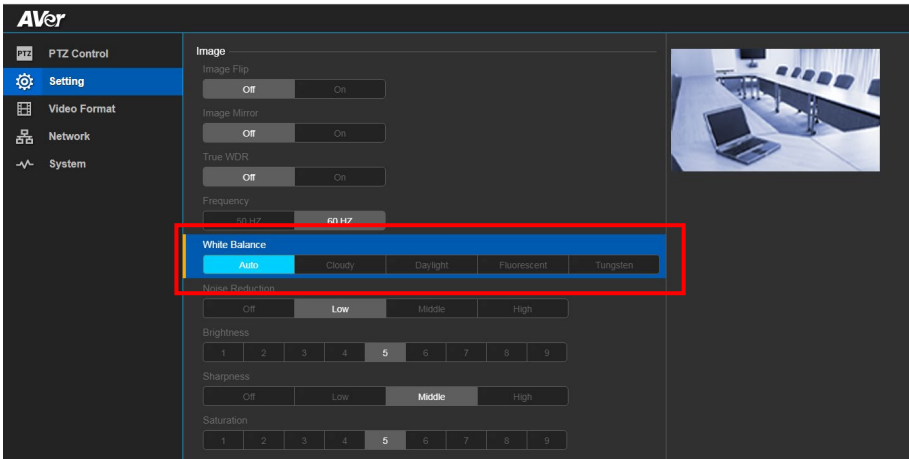

Noise Reduction

To reduce the noise from the signal.

In live screen view, select **"Setting"** > **"Image"** > **"Noise Reduction"** > **"Off"**, **"Low"**, **"Medium"** or **"High"**.

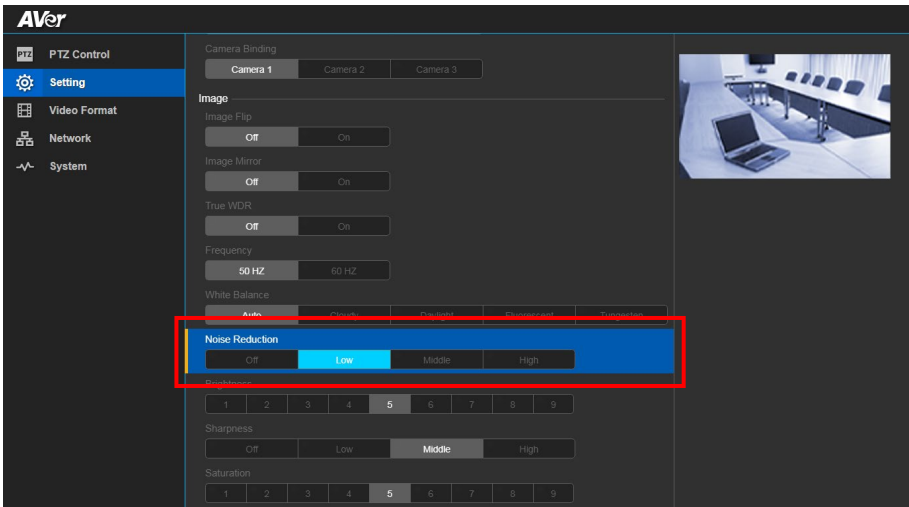

Brightness

Adjust the value of brightness.

In live screen view, select **“Setting”** > **“Image”** > **“Brightness”** > **“1-9”**.

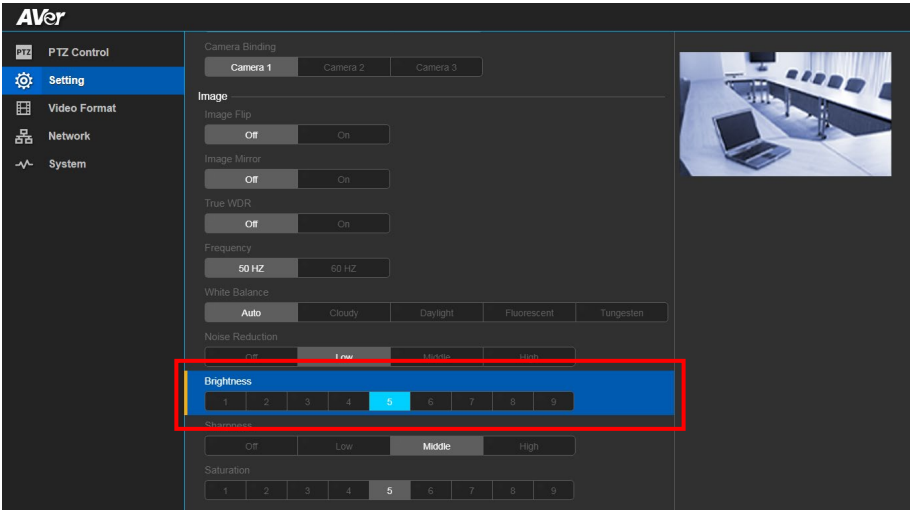

Sharpness

Adjust the value of sharpness.

In live screen view, select **“Setting”** > **“Image”** > **“Sharpness”** > **“Off”, “Low”, “Medium”** or **“High”**.

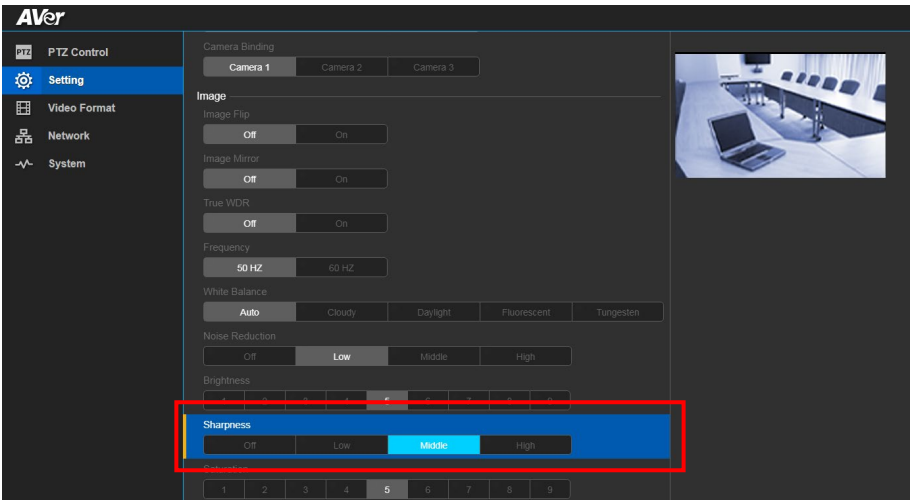

Saturation

Adjust the value of saturation.

In live screen view, select “**Setting**” > “**Image**” > “**Saturation**” > “1~9”.

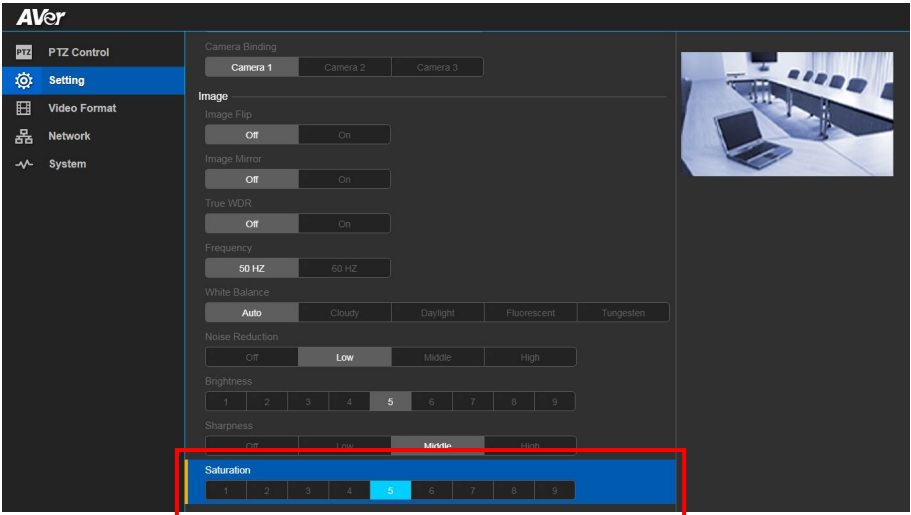

RS232 Setting

When CAM520 Pro connects with PTZ camera controller through the RS232 port, please setup **ADDR**, **Baud Rate**, **Visca Protocol**, **Visca Over IP** settings.

In live screen view, select “**Setting**” > “**RS232**”.

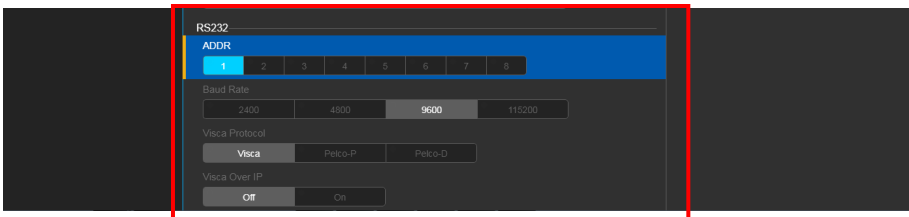

Video Format Setting

IP Stream Resolution

Select the resolution for IP stream. Not supported for USB video stream.

In live screen view, select **"Video Format"** > **"IP stream resolution"** > **"1080P"**, **"720P"**, **"480P"**, or **"360P"**.

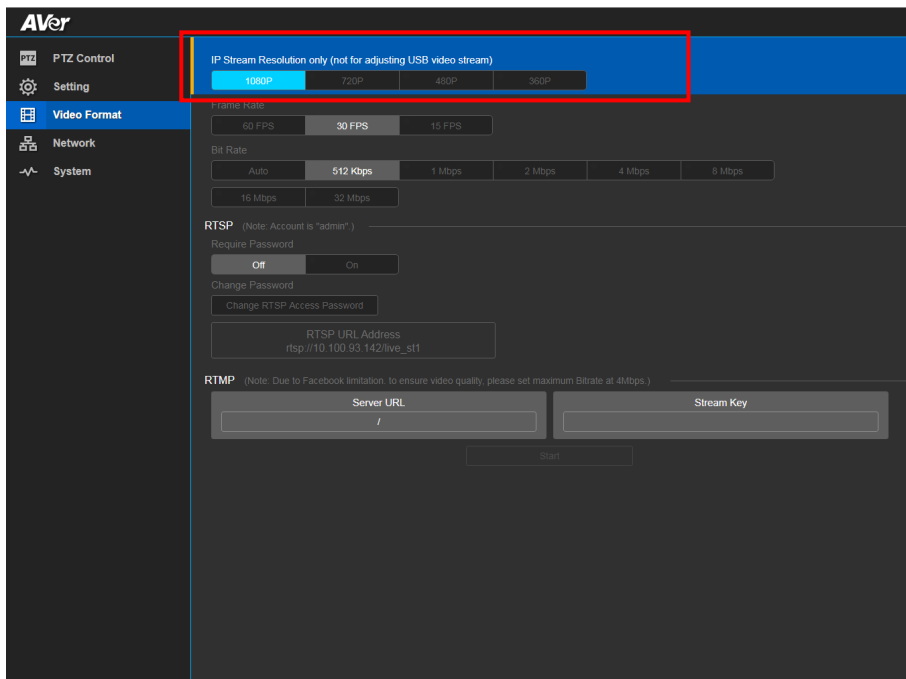

Frame Rate

Select the frame rate value..

In live screen view, select **"Video Format"** > **"Frame Rate"** > **"60FPS"**, **"30FPS"**, or **"15FPS"**.

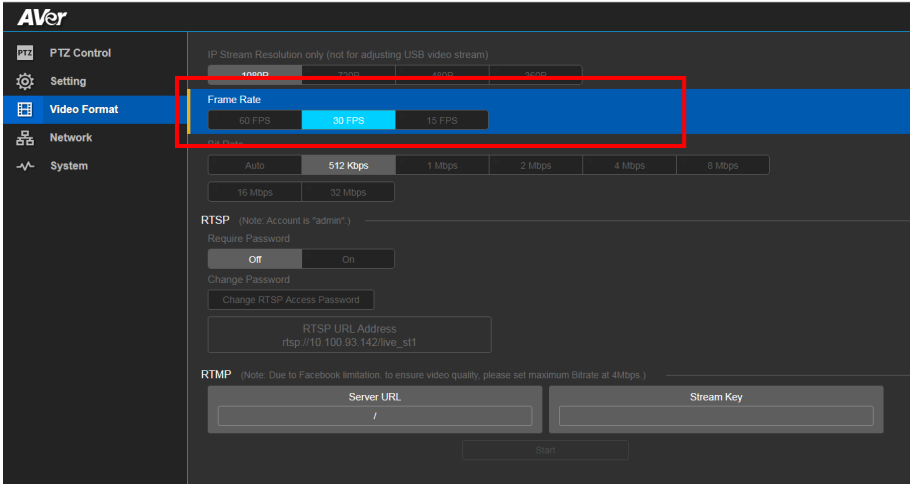

Bit Rate

Select the bit rate value.

In live screen view, select **"Video Format"** > **"Bit Rate"** > **"Auto"**, **"512Kbps"**, **"1Mbps"**, **"2Mbps"**, **"4Mbps"**, or **"8Mbps"**.

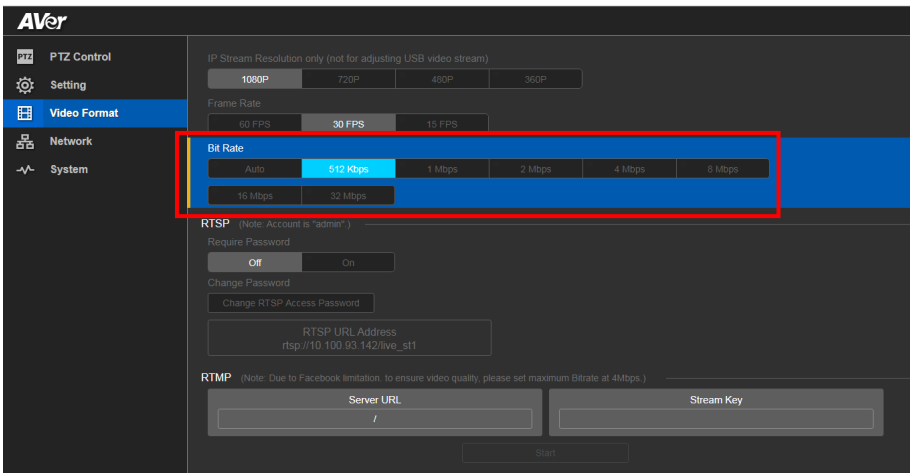

RTSP

To use RTSP player connecting to the camera, please enter the RTSP URL which displays on the web in your application such as VLC, PotPlayer or Quick Time.

Select “On” to enable RTSP function.

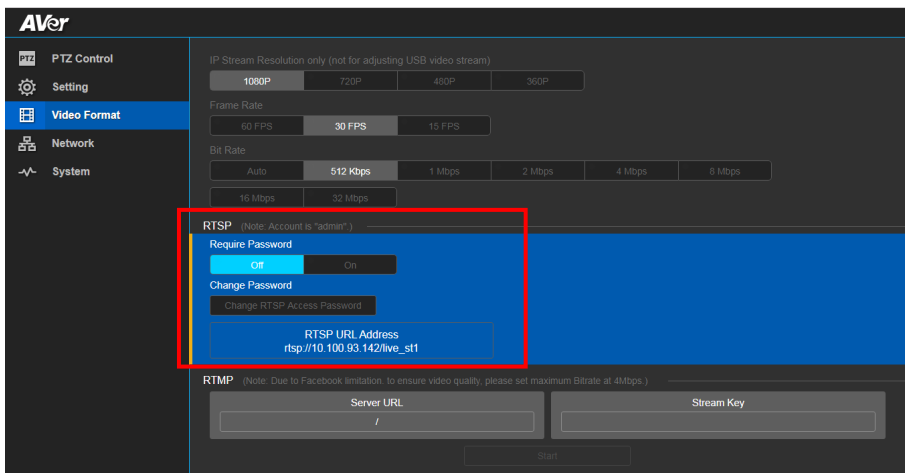

Change RTSP Password

1. In live screen view, select **“Video Format”** > **“RTSP”** > **“Change RTSP Access Password”**.
2. Enter the new password.
3. Select **“Change”** to save the new password.

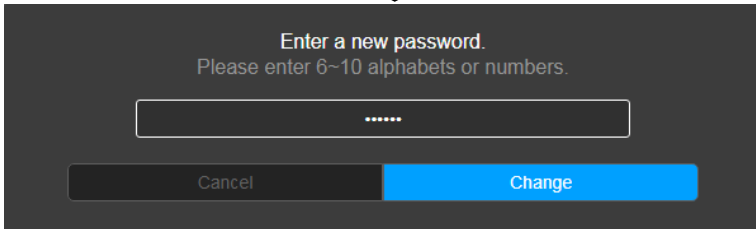
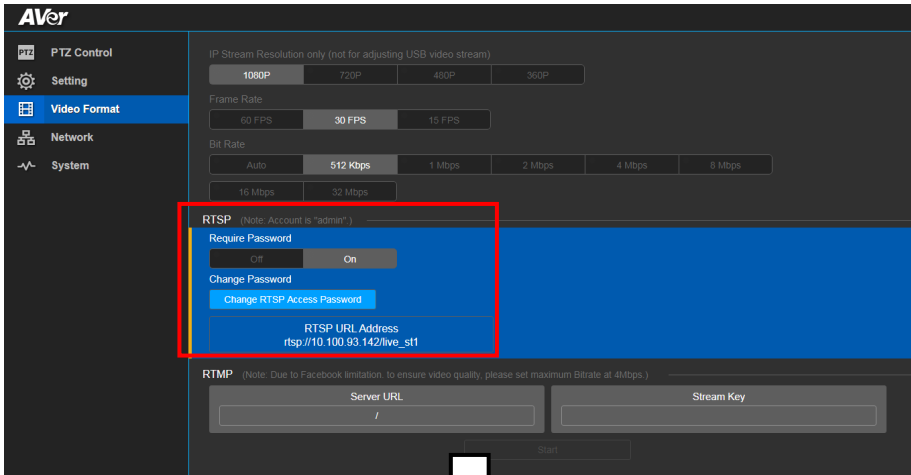

RTMP

Setup for uploading the camera's live view to the broadcasting platform (ex: Youtube).

In live screen view, select **"Video Format" > "RTMP"**

1. Locate the RTMP server URL and stream key from the broadcasting platform and enter in **"Server URL"** and **"Stream Key" column**.
2. Select **"Start"** to begin uploading the live video of the camera to the broadcasting platform.
3. Select **"Stop"** to stop uploading the video.

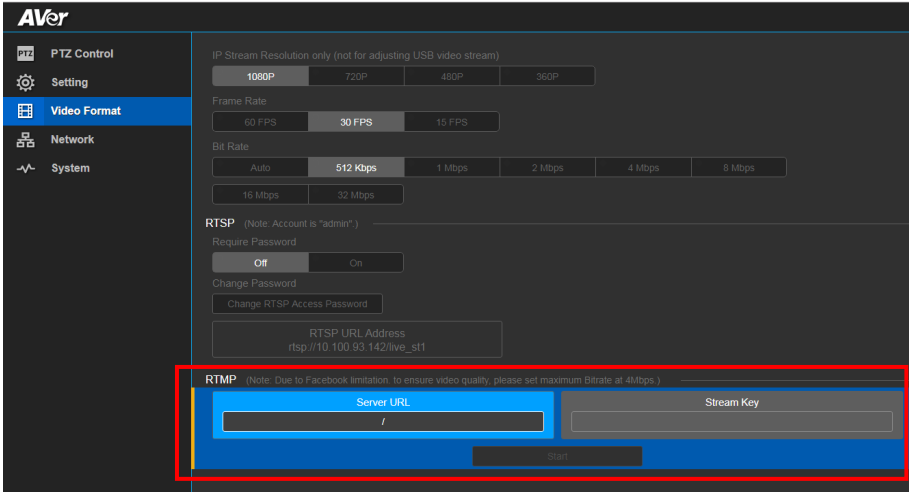

Network Setting

DHCP

Enable/disable DHCP function.

In live screen view, select **“Network”** > **“DHCP”** > **“Off”** or **“On”**.

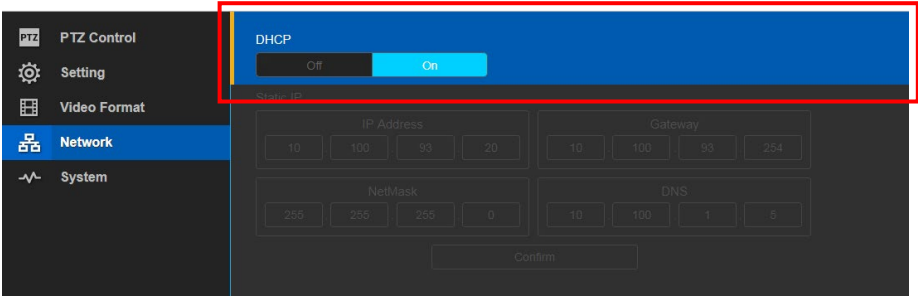

Static IP

Assign a fixed IP address to the camera. Please turn off the DHCP function.

1. In live screen view, select **“Network”** > **“Static IP”**.
2. Enter the **“IP Address”**, **Gateway**, **NetMask**, and **“DNS”** in the corresponding column.
3. Select **“Confirm”** to complete the setting.

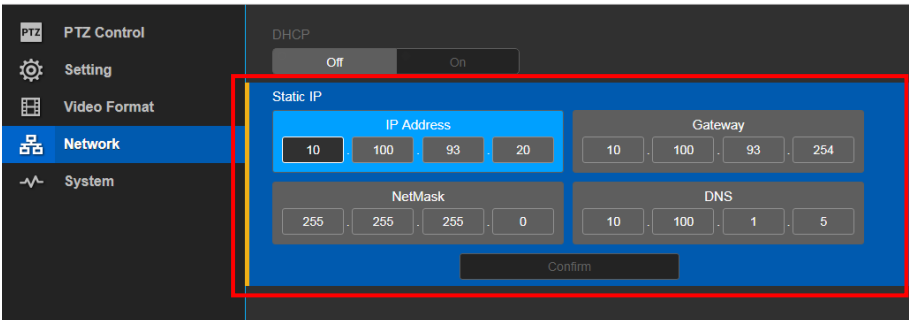

System Setting

Language

Select the language of the system.

In live screen view, select “System” > “Language” > “English” or “Traditional Chinese”.

[Note] More languages will be added in the future without further notice.

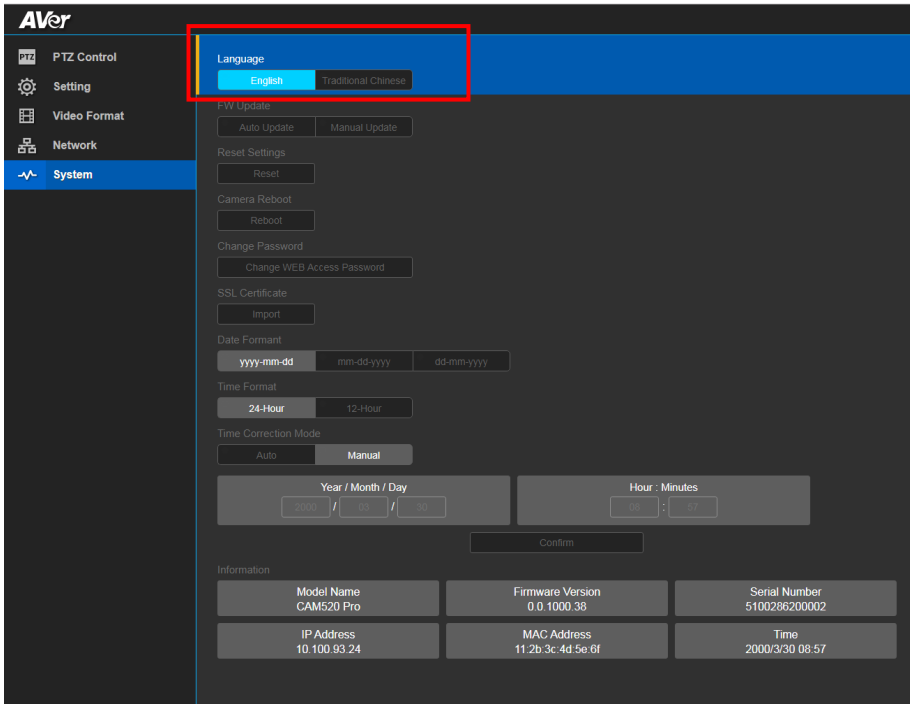

FW Update

Update the camera's firmware.

In live screen view, select **"System"** > **"FW Update"** > **"Auto Update"** or **"Manual Update"**.

- **Auto Update:** The system will check firmware and update automatically. If the firmware is on the latest version, then update will not perform.
- **Manual Update:** To update the firmware from specific location.

After updating, the camera will **reboot** and the connection will be lost. User needs to re-connect after rebooting.

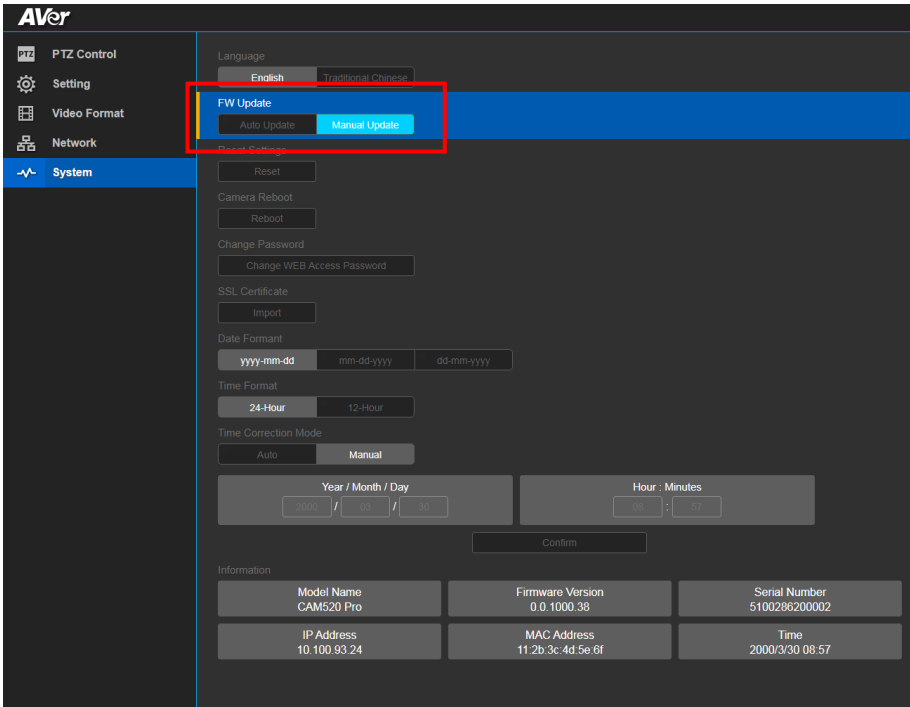

The screenshot displays the AVer camera's web management interface. The left sidebar contains navigation options: PTZ Control, Setting, Video Format, Network, and System. The 'System' menu is selected and highlighted in blue. The main content area shows the 'FW Update' section, which is highlighted with a red box. Within this section, there are two buttons: 'Auto Update' and 'Manual Update'. Below the 'FW Update' section, there are various system configuration options including 'Reset', 'Camera Reboot', 'Change Password', 'SSL Certificate', 'Date Format', 'Time Format', and 'Time Correction Mode'. At the bottom, there is an 'Information' table showing system details.

Information		
Model Name CAM520 Pro	Firmware Version 0.0.1000.38	Serial Number 5100286200002
IP Address 10.100.93.24	MAC Address 11.2b.3c.4d.5e.6f	Time 2000/3/30 08:57

Reset Settings

Reset the camera back to factory default setting.

1. In live screen view, select **“System”** > **“Reset Settings”**.
2. Select **“Reset”**
3. Select the **“OK”** to reset back to factory default.

[Note] When factory default is activated, the password of Webpage login and RTSP will not be set to default.

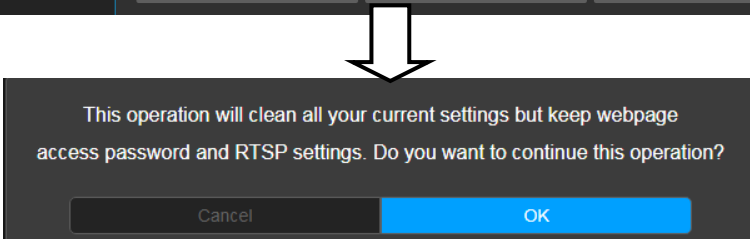
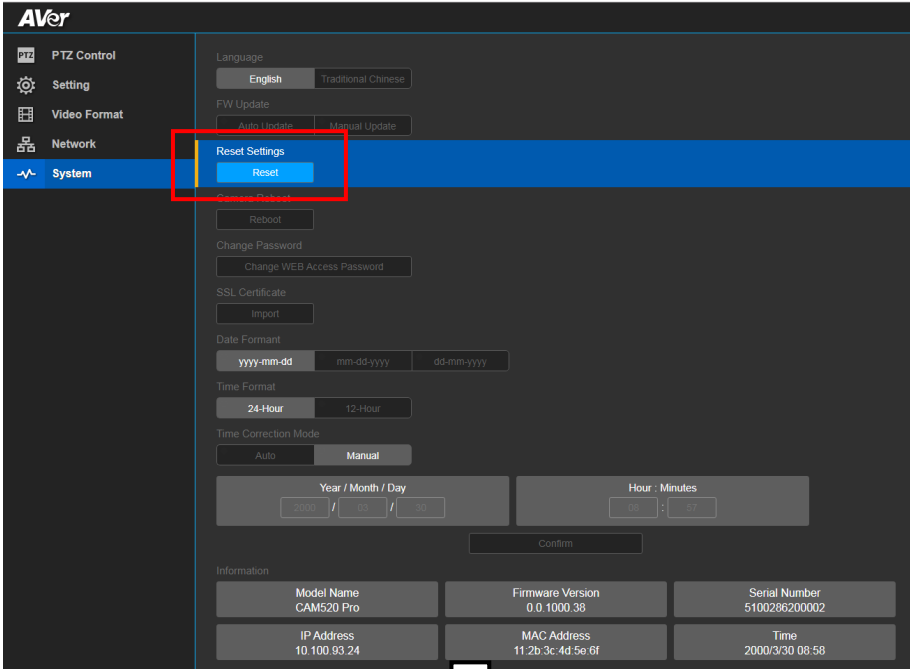

Camera Reboot

Restart the camera manually.

1. In live screen view, select **“System”** > **“Camera Reboot”**.
2. Select **“Reboot”**.
3. Select the **“Continue”** to reboot the camera.

The screenshot shows the AVer camera web interface. The left sidebar has a menu with options: PTZ Control, Setting, Video Format, Network, and System (highlighted). The main content area shows the 'Camera Reboot' section with a 'Reboot' button. Below this are sections for 'Change Password', 'SSL Certificate', 'Date Formant', 'Time Format', and 'Time Correction Mode'. At the bottom, there is an 'Information' table.

Information		
Model Name CAM520 Pro	Firmware Version 0.0.1000.38	Serial Number 5100286200002
IP Address 10.100.93.24	MAC Address 11.2b.3c.4d.5e.6f	Time 2000/3/30 08:59

A confirmation dialog box with a dark background and white text. It asks 'Are you sure you want to reboot the camera.' and has two buttons: 'Cancel' and 'Continue'.

Change Password

Change the Web login password. The default password is “**aver4321**”.

1. In live screen view, select “**System**” > “**Change Password**” > “**Change WEB Access Password**”.
2. Enter the old password, then enter the new password.
3. Select “**Change**” to save the new password.
4. If users forget the password and want to revert back to the default password, please use PTZApp (on FW update page) or OSD to reset it.

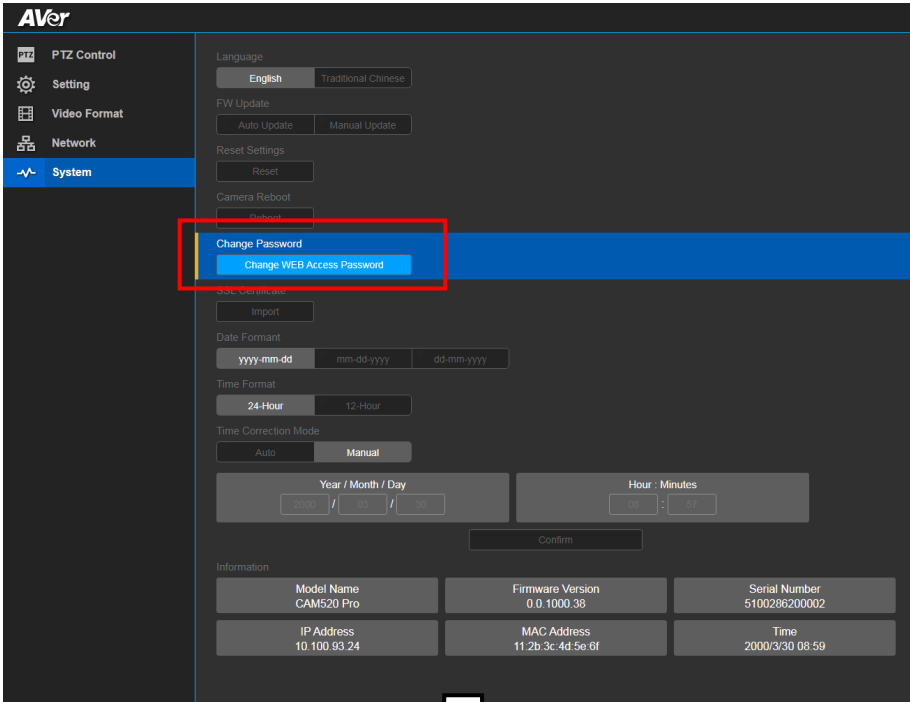

Enter the old password

Enter a new password. Please enter 6~10 alphabets or numbers.

Cancel Change

SSL Certificate

Import the SSL certificate from specific location.

1. In live screen view, select **"System"** > **"SSL Certificate"**.
2. Select the type by clicking "+".
3. Direct the file location.
4. Select "Import".

AVer

PTZ Control
Setting
Video Format
Network
System

Language
English Traditional Chinese

FW Update
Auto Update Manual Update

Reset Settings
Reset

Camera Reboot
Reboot

Change Password
Change Web Access Password

SSL Certificate
Import

Note: Forward
yyyy-mm-dd mm-dd-yyyy dd-mm-yyyy

Time Format
24-Hour 12-Hour

Time Correction Mode
Auto Manual

Year / Month / Day 2000 / 03 / 30 Hour : Minutes 05 : 57

Confirm

Information

Model Name CAM520 Pro	Firmware Version 0.0.1000.38	Serial Number 5100286200002
IP Address 10.100.93.24	MAC Address 11.2b.3c.4d.5e.6f	Time 2000/3/30 09:01

Note: After importing the SSL certificate, you will be back to login.

+ +

kerker.key kerker.pem

Cancel Import

Date Format

Select the date format.

In live screen view, select **“System”** > **“Date Format”** > **“yyyy-mm-dd”**, **“mm-dd-yyyy”**, or **“dd-mm-yyyy”**.

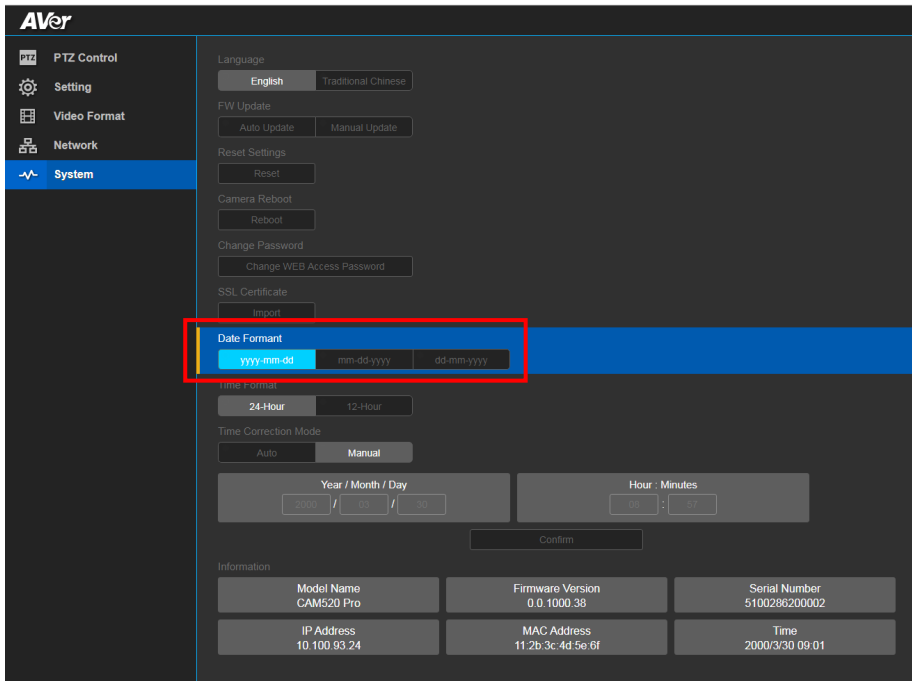

The screenshot displays the AVer system configuration interface. The left sidebar shows the navigation menu with "System" selected. The main content area shows the "Date Formant" configuration screen, which is highlighted with a red box. The "Date Formant" section has three radio button options: "yyyy-mm-dd" (selected), "mm-dd-yyyy", and "dd-mm-yyyy". Below this, there are sections for "Time Format" (24-Hour and 12-Hour), "Time Correction Mode" (Auto and Manual), and "Year / Month / Day" and "Hour : Minutes" input fields. At the bottom, there is a "Confirm" button and an "Information" table.

Information		
Model Name CAM520 Pro	Firmware Version 0.0.1000.38	Serial Number 5100286200002
IP Address 10.100.93.24	MAC Address 11:2b:3c:4d:5e:6f	Time 2000/3/30 09:01

Time Format

Select the time format.

In live screen view, select **“System”** > **“Time Format”** > **“24-Hour”** or **“12-Hour”**.

The screenshot displays the AVer PTZ Control web interface. The left sidebar contains navigation options: PTZ Control, Setting, Video Format, Network, and System (highlighted in blue). The main content area shows various system settings. The 'Date Format' section is expanded, showing three options: 'www-mm-dd', 'mm-dd-www', and 'ddmm-yyyy'. Below this, the 'Time Format' section is highlighted with a red box, showing two options: '24-Hour' (selected) and '12-Hour'. Below the 'Time Format' section, there are fields for 'Year / Month / Day' (2000 / 03 / 30) and 'Hour : Minutes' (09 : 57), a 'Confirm' button, and an 'Information' section with a table of system details.

Information		
Model Name	Firmware Version	Serial Number
CAM520 Pro	0.0.1000.38	5100286200002
IP Address	MAC Address	Time
10.100.93.24	11.2b.3c.4d.5e.6f	2000/3/30 09:02

Time Correction Mode

Adjust time by auto or manual.

In live screen view, select “**System**” > “**Enable NTP**” > “**Auto**” or “**Manual**”.

- **Auto:** The system time will be set by NTP server on the network. Enter the IP address of NTP server and select the **Time Zone**. Select **NTP Update** to save setting. Select **Activate** to start auto time adjustment.

[Note] Our default NTP server is located in the USA. If this does not work in your country, please manually key in the desired NTP server.

The screenshot shows the 'Time Correction Mode' interface. At the top, there are two buttons: 'Auto' (highlighted in blue) and 'Manual'. Below these are three input fields: 'NTP Server' (empty), 'Time Zone' (set to 'UTC-12:00'), and 'NTP Update'. At the bottom center is an 'Activate' button.

- **Manual:** User can set up time manually. Enter the **Year, Month, Day, Hour,** and **Minutes**. Select **Confirm** to save the settings.

The screenshot shows the 'Time Correction Mode' interface in Manual mode. The 'Manual' button is highlighted in blue. Below it are two input fields: 'Year / Month / Day' (set to '2000 / 03 / 30') and 'Hour : Minutes' (set to '08 : 57'). At the bottom center is a 'Confirm' button.

Information

Display the information of **Model Name**, **Firmware Version**, **Serial Number**, **IP Address**, **MAC Address**, and **Time**.

In live screen view, select “**System**” > “**Information**”.

The screenshot shows the 'Information' screen with a table of system details:

Model Name VC520 Pro	Firmware Version 0.0.1000.36	Serial Number 5100293800025
IP Address 10.100.93.61	MAC Address 00:11:22:33:44:25	Time 2000/1/19 07:19

Using AVer PTZApp

Install AVer PTZApp

Please go to <http://www.aver.com/download-center> to download the AVer PTZApp. After downloading, double-click on the file and follow the on-screen instructions to complete the installation.

Using AVer PTZApp

1. Run your video application.
2. During your video call, you can use the AVer PTZApp to pan, tilt and zoom the camera in/out.
3. For the first time use, you can check the connection, camera, and setup the camera's parameters.

Each function will be described below:

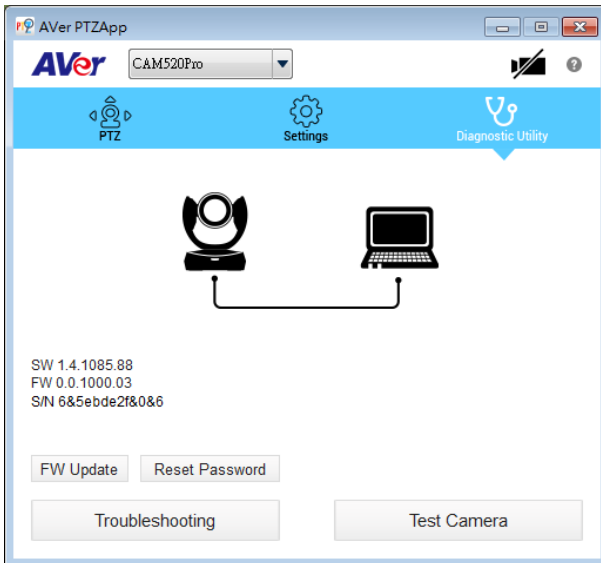

- **Currently selected device:** This field displays currently selected VC or CAM device controlled by PTZApp. If you have more than one AVer VC or CAM devices connected to this PC/Mac PTZApp is running, you can click on the drop-down list to select other AVer VC or CAM device.

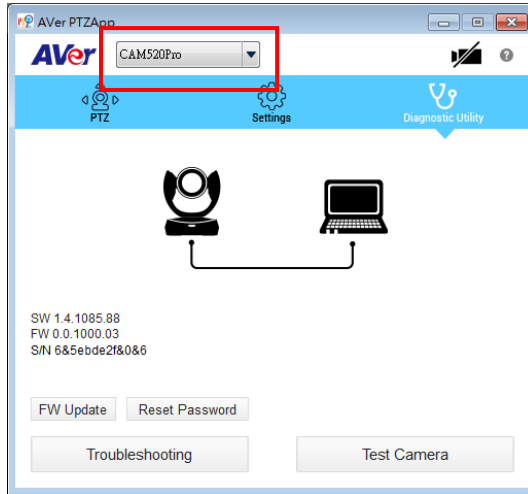

- **Function icon:** Click it to switch to the function's page.

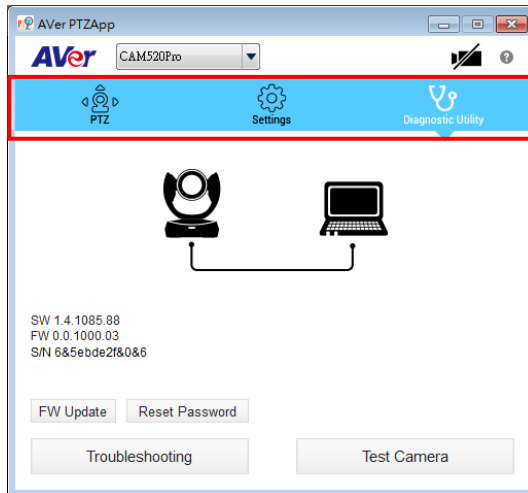

- **PTZ:** To control the camera direction, zoom in and out, and to enable/disable the backlight compensation during your video call.
 - **Smart Framing:** One-click automatic FOV(Field of View) adjustment to fit all participants. Click "**Smart Framing**" button to enable Smart Framing manually.
- [Note]** While in conferencing meeting, participants must face the camera for face detection (smart framing).

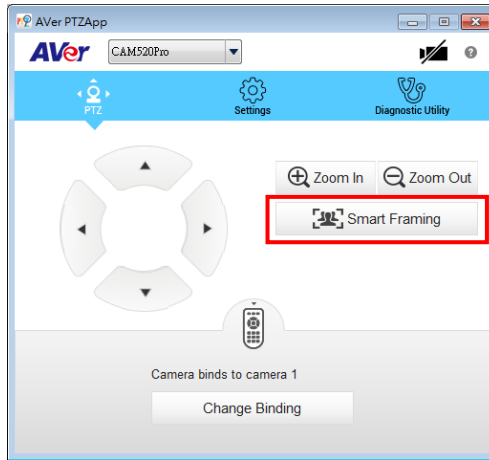

- **Settings:** To setup parameters of the camera. Click the **Save** button to save all settings. To change all the settings, back to the default values, click the **Factory Default** button.
- **Flip :** If the CAM520 Pro is installed in the upside down position, please enable the "**Flip**" function in the AVer PTZApp , and the screen will display normally.

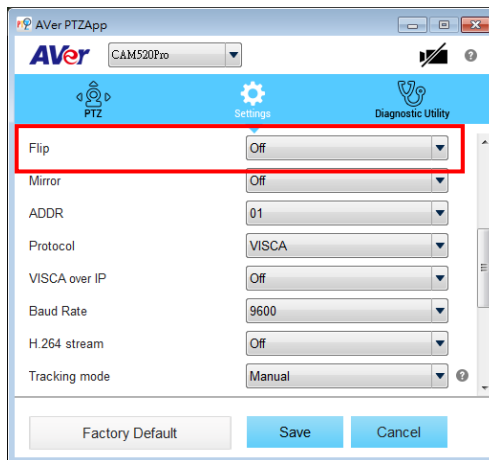

- **Tracking Mode:** It is a SmartFrame function. One-click automatic FOV(Field of View) adjustment to fit all participants. The user can set SmartFrame to manual, auto, or off mode. When mode is off, the hotkey on the remote controller cannot be used.
[Note] While in conferencing meeting, participants must face the camera for face detection (Smart Framing).

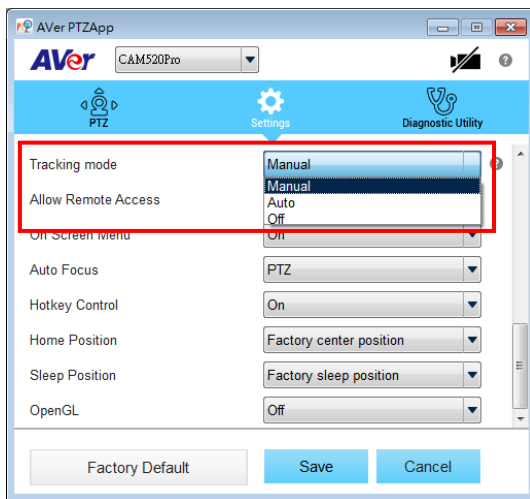

- **Diagnostic Utility:** To display the S/W and F/W version and the devices connection status. You can update the firmware of the camera and reset Web login password.

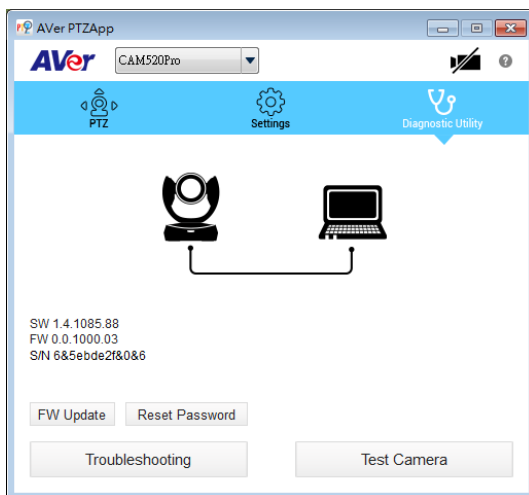

- **Minimize:** Minimize the app to system tray. To quit the application, right-click the icon on the system tray and select **Quit**.

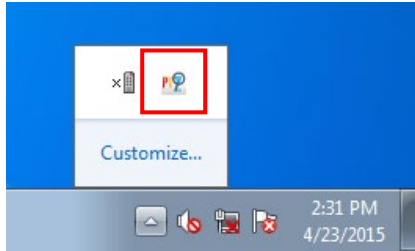

-  : Click icon will launch the browser and connect to the AVer PTZApp web page.

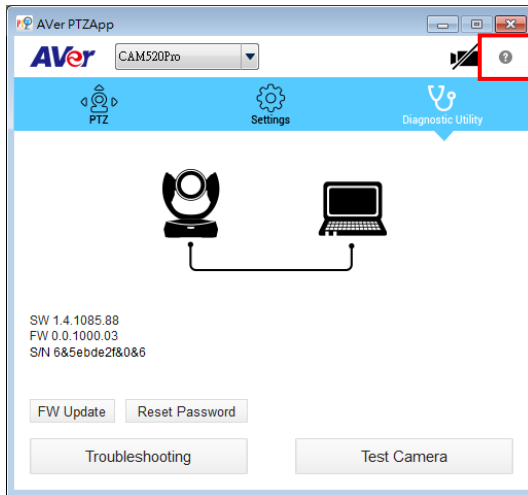

- [REDACTED] **(Camera):** Click it to view the camera live view. Click the camera icon again to close the camera live view. If the live video did not appear, please check the camera and the laptop/PC connection to make sure all are corrected and well connected.



Normal

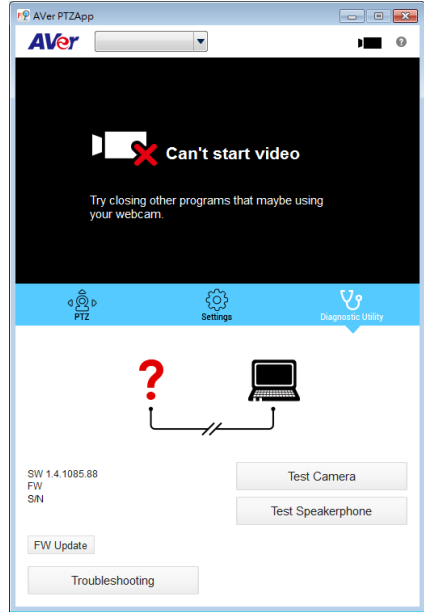

Un-normal

- Connection diagnostic:** Display devices connection status. If the AVer PTZApp has detected that camera and laptop/PC are not connected well, the diagram will display an “?” on the camera to indicate the connection has a problem. If the camera is in use by another application, it will display “Can't start video” warning.

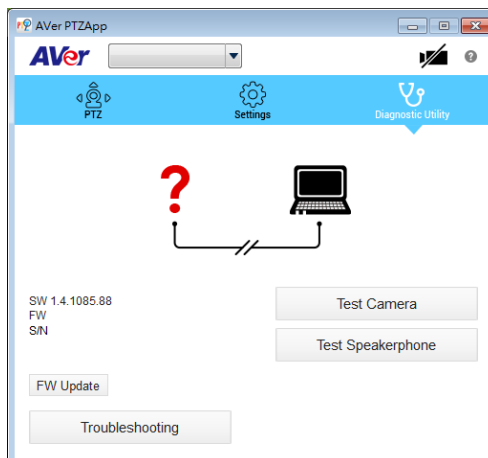

- Test Camera:** Click the “**Test Camera**” to check the camera video display status. You can adjust the camera direction and view of the zoom in/out. To leave the page, click the **Abort Diagnostic** button.



- FW Update:** Allows the user to update the CAM520 PRO camera’s firmware.
 - Click “**FW Update**”.
 - A dialog will display the current firmware version and available new firmware version (internet connection is required).

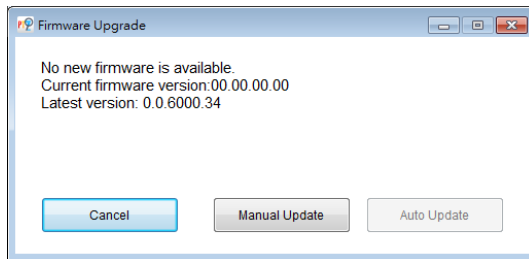

- To auto update, click “**Auto Update**” and update process will start. The new firmware will be downloaded first; then, the new firmware will be uploaded to the camera.

[Note] Please make sure camera, power, and laptop/PC are all well connected and stay connected during the entire process.

- To update the firmware manually, click “**Manual Update**” and locate the new firmware to start the process.

- **Troubleshooting:** collect more system information for troubleshooting before you contact AVer technical support.

Set the Camera Number

With multiple cameras connection, users can set each camera to buttons 1 to 3 on the remote control.

1. If PTZApp detects computer connects to multiple VC/CAM, you can select which camera you like to control through the dropdown list.
2. Next, Click **Change Binding** button.

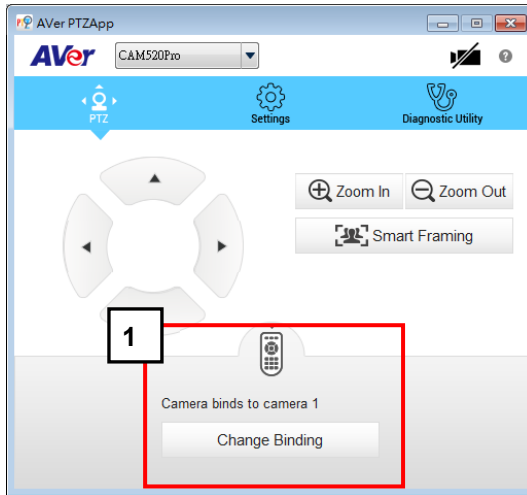

3. Select which camera number of remote control it maps to.
4. Click **Save** to save settings. To un-save the settings, click **Abort**.

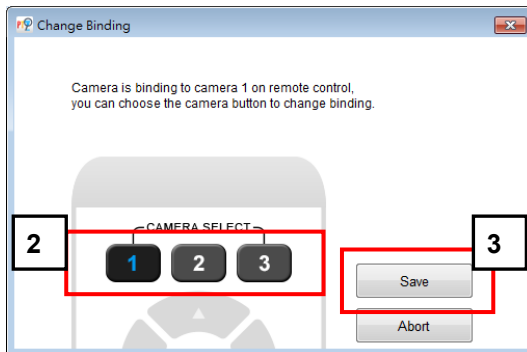

[Note] If you only have one camera and don't need to do any setting, the default is camera 1. If you press camera 2 or 3 on the remote control, you will find your remote can't control your camera. In this case, please press camera 1 on your remot again.

Hotkey Control

Enable hotkey control to use keyboard control camera's movement, backlight, and Smart Framing.

1. Select **"Settings"**
2. Set Hotkey Control to **"On"**.

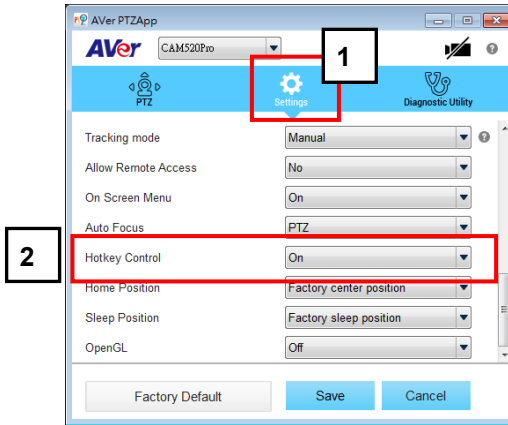

3. A hotkey description as below figure shown:



4. When hotkey control is enabled, a hotkey tip will display when mouse is moved to the PTZ control button in PTZ mode.

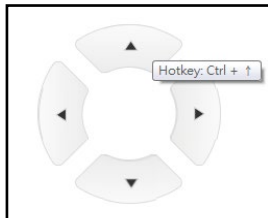

5. If the hotkey function is enabled after installed PTZApp, PTZApp auto launch next time PC reboot. Therefore, the customer can use all the hotkey commands since PTZApp is auto running in system tray.

Reset Password

Set Web access password back to default. The default password is “**aver4321**”.

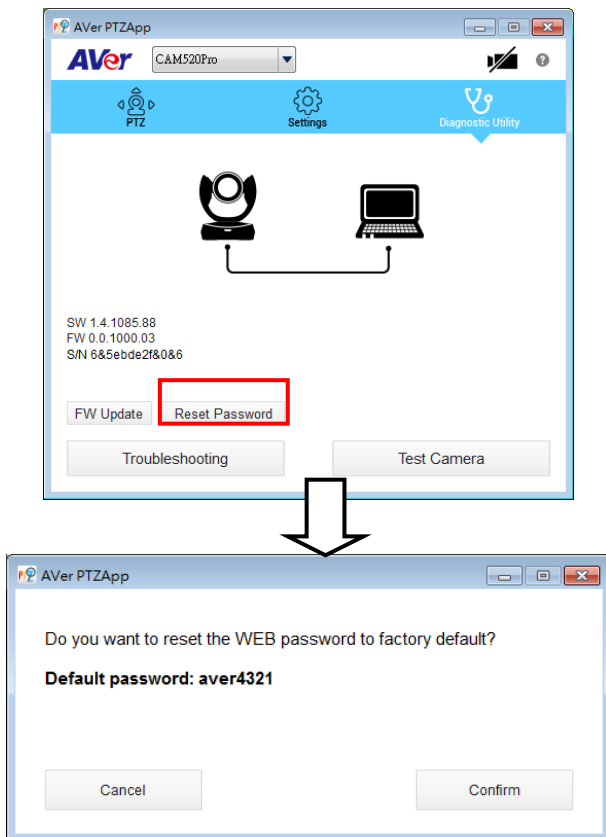

Home / Sleep Position

Home Position: There are three options: Last operating position/Factory central position/ Preset 0

Sleep Position: There are two options -- Factory sleep position/ Preset 9

If the camera idles for more than 3 minutes, it will enter sleep mode.

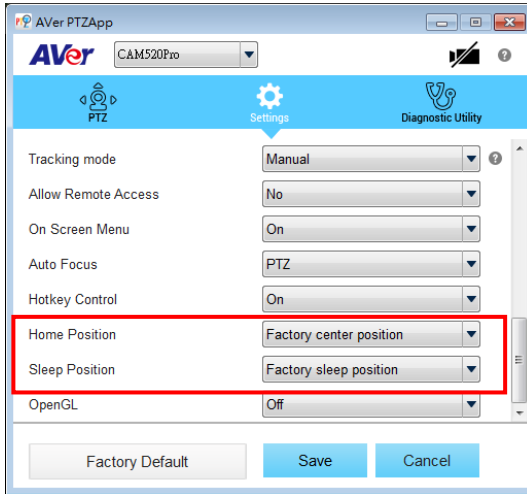

ADDR / Protocol/Baud Rate

These settings are related to RS232 functions. Please choose the corresponding value while connecting with external control panels.

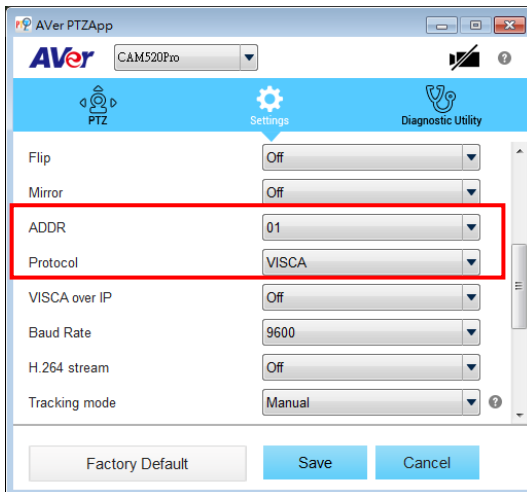

OpenGL

The default setting is Off. If your PC has installed OpenGL, you can get better frame rate and smoother video quality by turn on it. If your PC is without OpenGL, it will cause video display problem after enable it.

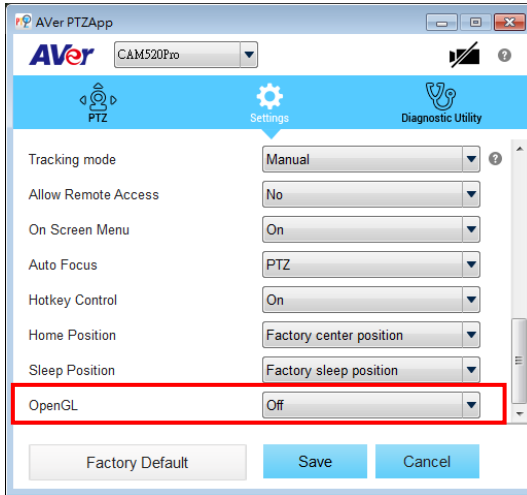

OSD Setup

For advanced model, user can connect the camera through the HDMI port to monitor or TV and use OSD menu to setup the camera.

After connecting with monitor/TV, press  button on remote controller to call out the OSD menu.

Use ▲, ▼, ◀, ▶ and  button to move between the selection and confirm the selection.

To exit or leave current setting page/selection, press  button.

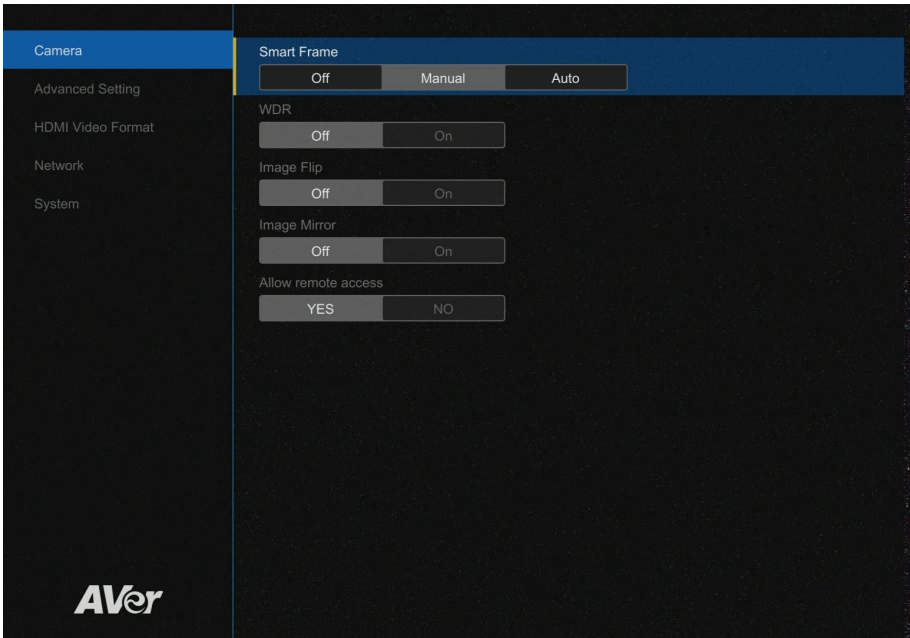

Camera Settings

Smart Frame

One-click automatic FOV(field of view) adjustment to fit all participants.

Select **“Camera”** > **“Smart Frame”** > **“Off”**, **“Manual”** or **“Auto”**.

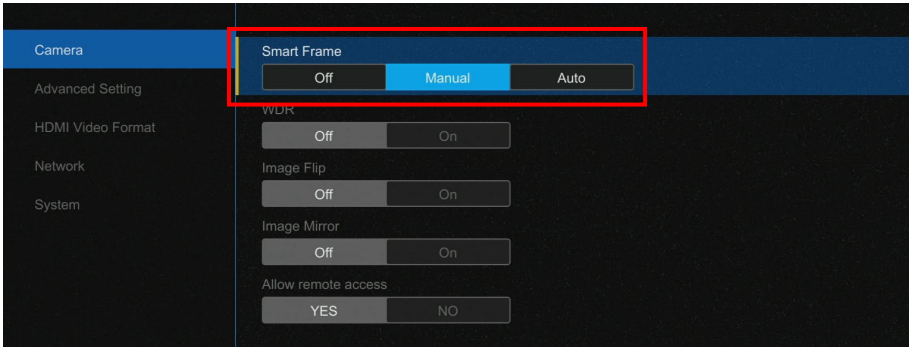

WDR

In back light environment, enabling WDR can improve the brightness of image.

Select **“Camera”** > **“WDR”** > **“Off”** or **“On”**.

[Note] While WDR is on, the frame rate will drop and cause image blur if there are moving objects. Please turn off WDR when in normal light conditions.

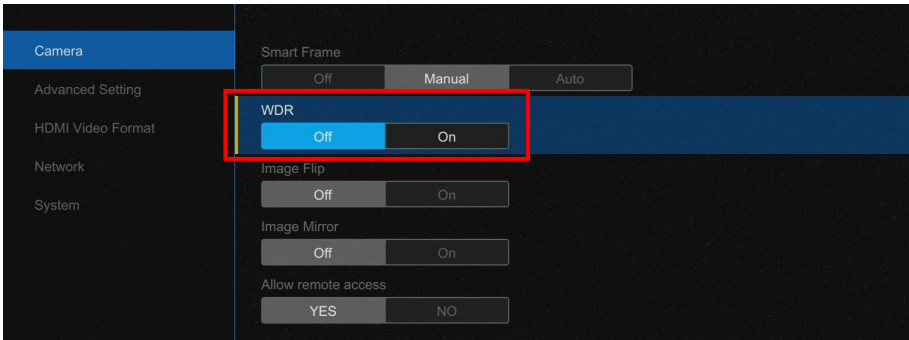

Image Flip

If the CAM520 Pro is installed in the upside down position, please enable the "Flip".
Select "Camera" > "Image Flip" > "Off" or "On".

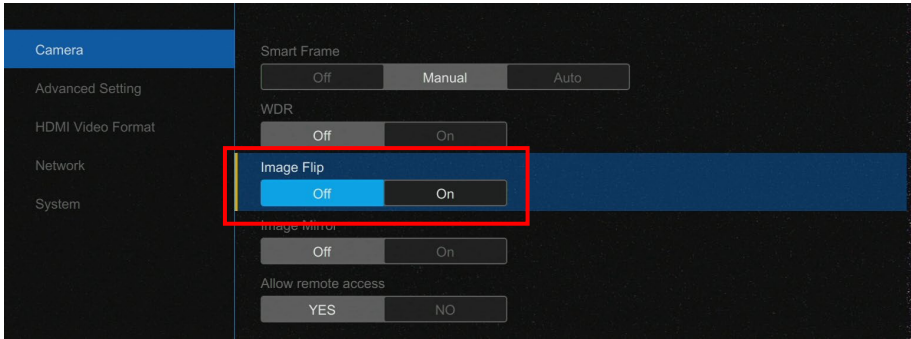

Image Mirror

To mirror the camera image.
Select "Camera" > "Image Mirror" > "Off" or "On".



Allow Remote Access

Set the Web access authority.

Select "Camera" > "Allow remote access" > "YES" or "NO".

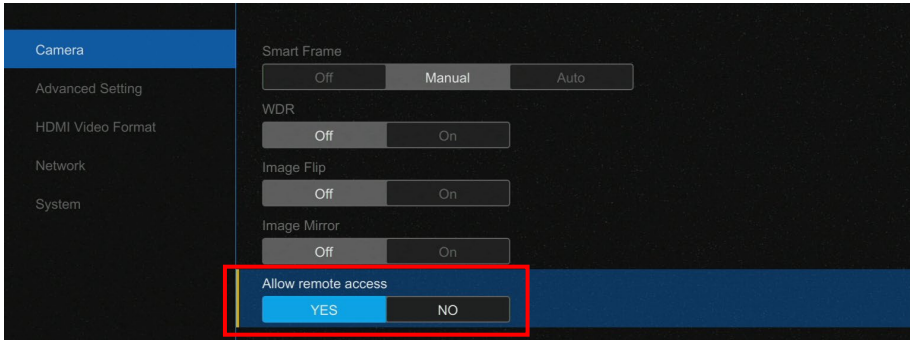

Advanced Setting

Auto Focus

Set auto focus mode.

In live screen view, select “**Advanced Setting**” > “**Auto Focus**” > “**PTZ**” or “**Continuous**”.

- **PTZ:** By clicking the button(such as pan, tilt, zoom in/out) to adjust focus once.
- **Continuous:** The camera will adjust the focus when the objects have moved.

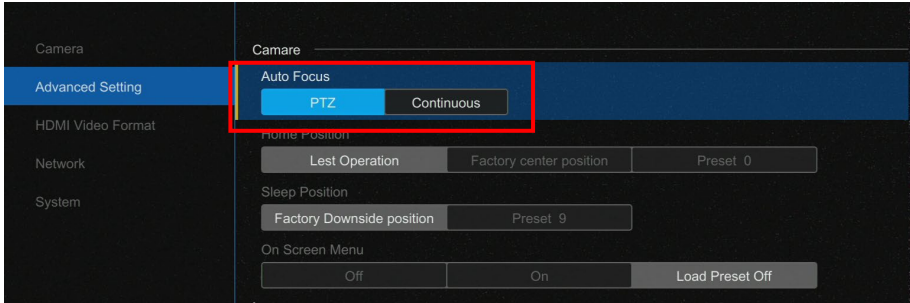

Home position

Set the home position for camera to return.

Select “**Advanced Setting**” > “**Home position**” > “**Last operating position**”, “**Factory central position**” or “**Preset 0**”.

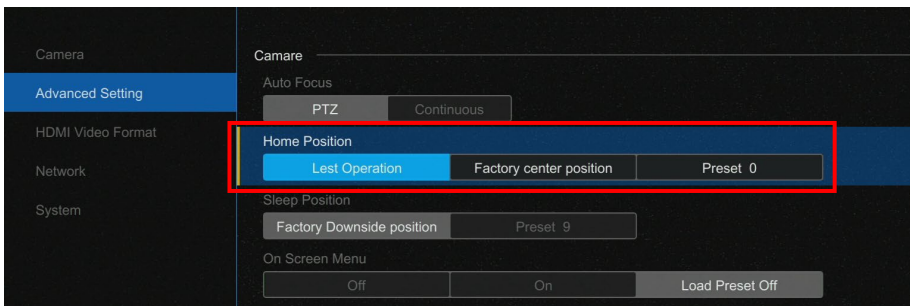

Sleep position

When the camera idles for more than 3 minutes, it will enter to sleep mode.

Select **"Advanced Setting"** > **"Sleep position"** > **"Factory central position"** or **"Preset 9"**.



On Screen Menu

Enable/disable on screen display status information.

Select **"Advanced Setting"** > **"On Screen Menu"** > **"Off"**, **"On"** or **"Load Preset off"**.

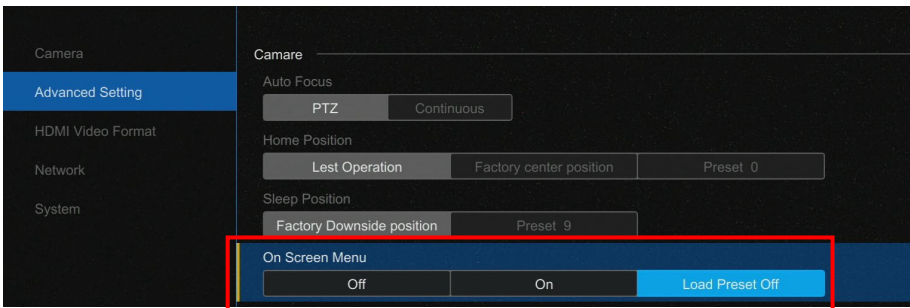

Frequency

Select the frequency of the camera.

Select **“Advanced Setting”** > **“Frequency”** > **“Auto”**, **“50Hz”**, or **“60Hz”**.

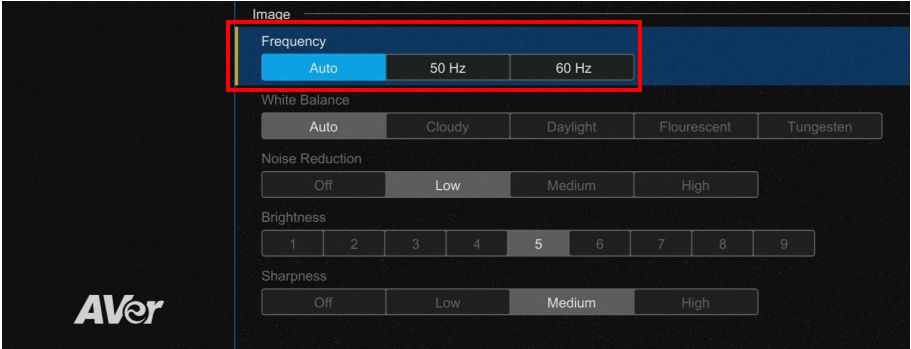

White Balance

Select the White Balance setting for various light conditions or color temperature.

Select **“Advanced Setting”** > **“White Balance”** > **“Auto”**, **“Cloudy”**, **“Daylight”**, **“Fluorescent”**, or **“Tungsten”**.

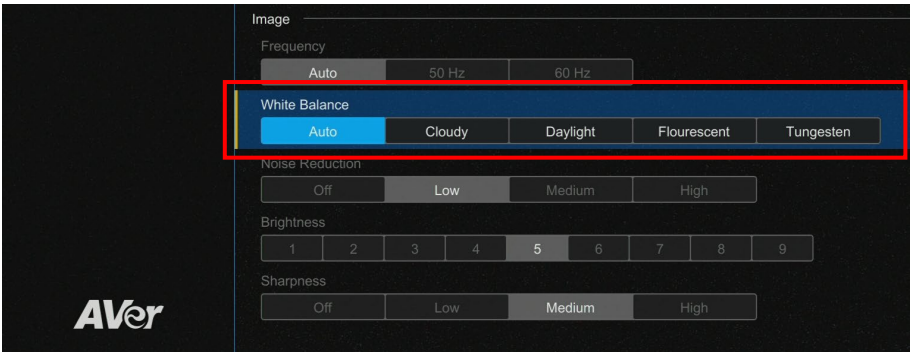

Noise Reduction

To reduce the noise from the signal.

Select **“Advanced Setting”** > **“Noise Reduction”** > **“Off”**, **“Low”**, **“Medium”**, or **“High”**.



Brightness

Adjust the value of brightness.

Select **“Advanced Setting”** > **“Brightness”** > **“1-9”**.



Sharpness

Adjust the value of sharpness.

In live screen view, select **“Advanced Setting”** > **“Image”** > **“Sharpness”** > **“Off”**, **“Low”**, **“Medium”**, or **“High”**.



Saturation

Adjust the value of saturation.

Select **“Advanced Setting”** > **“Image”** > **“Saturation”** > **“1-9”**.

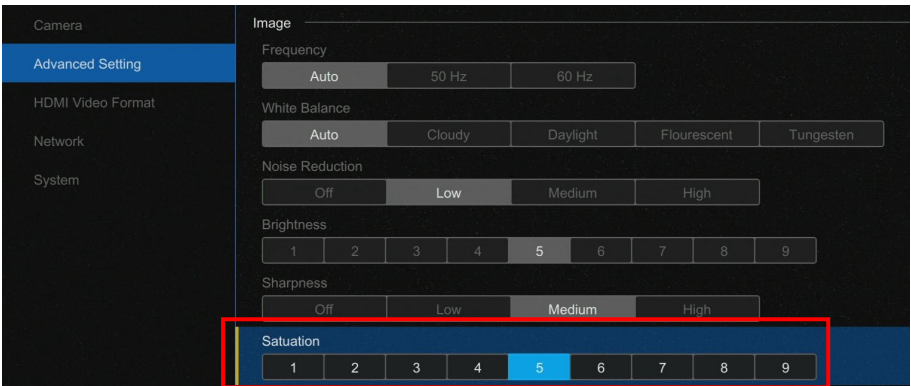

RS232 Setting

When CAM520 Pro connects with PTZ camera controller through the RS232 port, please setup **ADDR**, **Baud Rate**, **VISCA Protocol**, **Visca Over IP** settings.

Select "**Advanced Setting**" > "**RS232**".

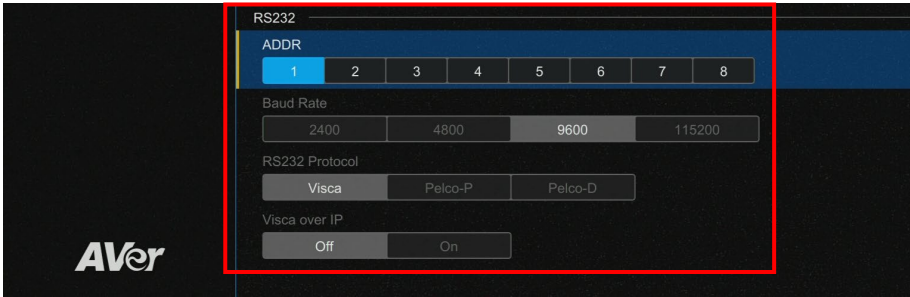

HDMI Video Format

Select the video format for HDMI output.

Select "**HDMI Video Format**" > "**Auto**", "**1080p/60**", "**1080p/50**", "**1080p/30**", "**720p/60**", "**720p/50**", or "**480p/60**".

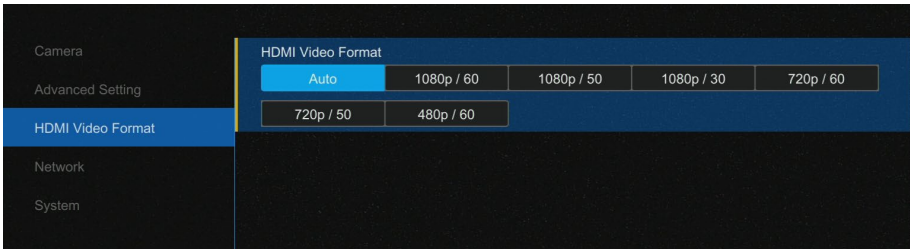

Network

DHCP

Enable/disable DHCP function.

Select **"Network"** > **"DHCP"** > **"Off"** or **"On"**.

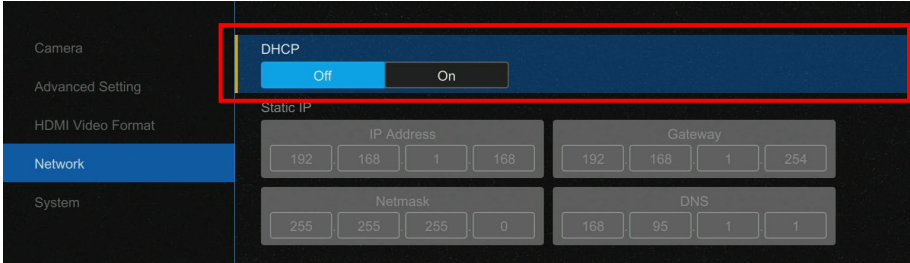

Static IP

Assign a fixed IP address to the camera. Please turn off the DHCP function.

1. Select **"Network"** > **"Static IP"**.
2. Enter the **"IP Address"**, **"Gateway"**, **"Netmask"**, and **"DNS"** in the corresponding column. Use the number key pad on remote control to enter the value.
3. After entering the value, press  to leave.

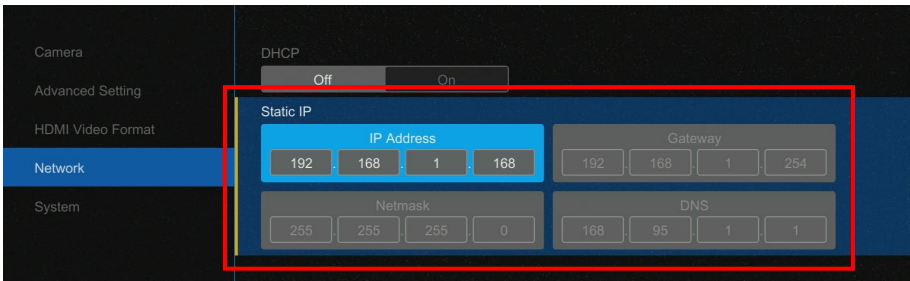

System Setting

Language

Select the language of the system.

Select **"System"** > **"Language"** > **"English"** or **"Traditional Chinese"**.

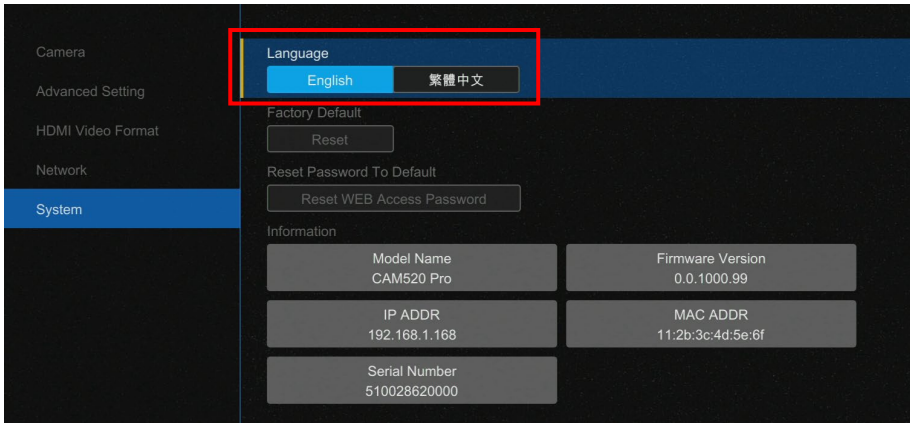

Factory Default

Reset the camera back to factory default setting.

1. Select **“System”** > **“Factory Default”**.
2. Select **“Reset”**
3. Select the **“Confirm”** to reset back to factory default.

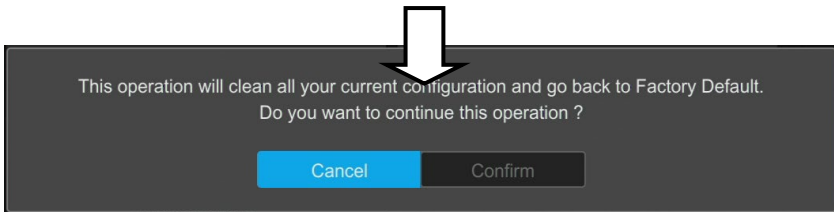

Change Password

Reset the Web login password to default. The default password is **“aver4321”**.

Select **“System”** > **“Reset WEB Access Password”**.

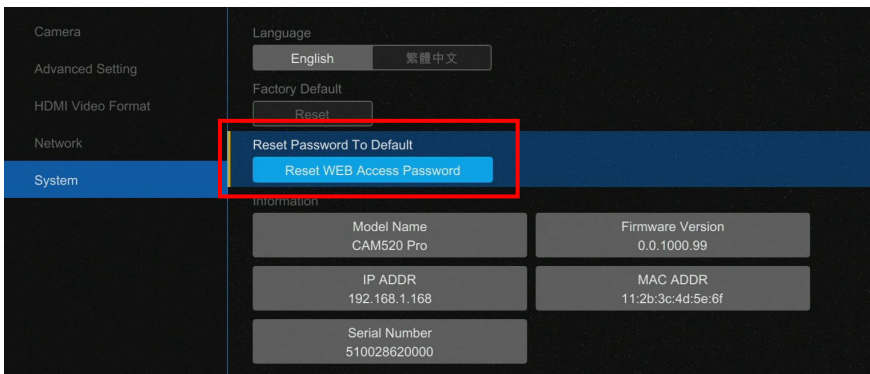

Information

Display the information of “**Model Name**”, “**Firmware Version**”, “**Serial Number**”, “**IP Address**”, “**MAC Address**”, and “**Time**”.

Select “**System**” > “**Information**”.

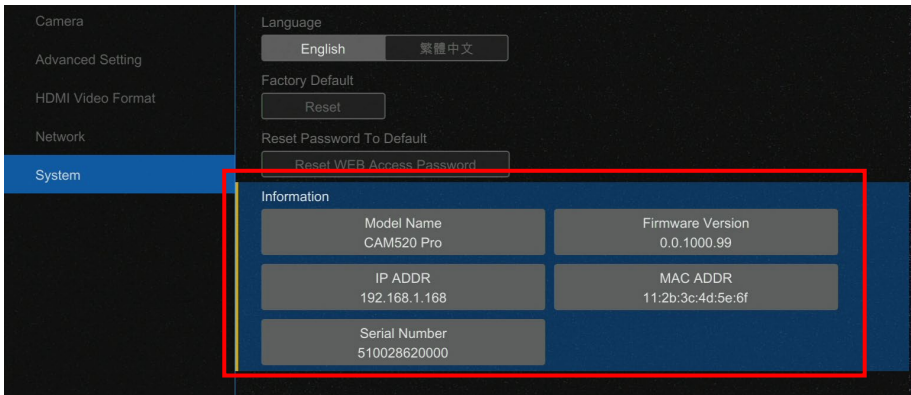

Install EZLive

Please go to <http://www.aver.com/download-center> to download the AVer EZLive software. After downloading, double-click on the file and follow the on-screen instructions to complete the installation.

Use AVer EZLive

During a video call, EZLive can help user to do:

- (1) Camera ePTZ
- (2) Volume control for the speaker connected
- (3) Capture camera's still images
- (4) Record video
- (5) Live stream to Youtube, Livehouse.in, USTREAM...etc.
- (6) Camera Zoom in/out
- (7) Capture PC screen shot
- (8) Record PC screen video
- (9) Set up livestream
- (10) Open file management to retrieve photos and video files
- (11) Livestream setting
- (12) Drawing tool.

