

## 1. Specifications:

Dimensions (HxWxD)	281 x 130 x 120mm
Cartridge Capacity	1000ml
Battery	C size 1.5 x 4pcs Alkaline
Sensing distance	~10cm
Room Temperature	4~40°C
Dose	~ 0.4ml 1shot / 0.7~0.8 ml 2 shots
Applicable Type	Foam/Gel/Spray

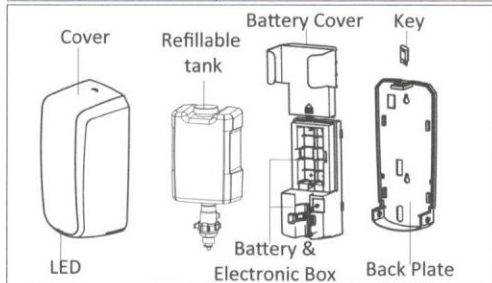

## 2. Item List:

	Item	Description	Q'ty
1		Dispenser	1
2		Installation Manual	1
3		Key	1
4		Plastic Anchor	3
5		Mounting Screw	3

## 3. Installation Step:

### ◆ Before Installation:

1. Check if surface of wall is smooth and clean.
2. Note the distance between to dispenser from counter top must be >40cm (As show in Fig. 1)

### ◆ Installation Steps:

1. Use key to unlock and remove the dispenser casing. ( Fig. 2)
2. Mark the location on the wall with a pencil. Use the dispenser to mark the location for the fixing point ①. (Fig. 3)
3. Drill holes at the marking point ①.  $\varnothing 5\text{mm}$   
Insert plastic anchor. (Fig. 4)
4. Insert screw in to anchors. Screw reserved 8mm . (Fig. 3)
5. Put the dispenser on the wall, after aligning with fixed hole, move the dispenser downward to make the ear-shaped hole or the dispenser buckle fastening.
6. Mark the location for the fixing point ②&③ . Remove the dispenser, Drill holes at the marking point ②&③ . Insert plastic anchor. (Fig 3&4)
7. Put the dispenser on the wall and two screw in to anchors, and fully screw in. (Fig. 5)

### ◆ Option:Tape Installation (Adhesive on Mirror)

1. Clean installation surface with isopropyl alcohol
2. Peel paper off of installation tape located on back of dispenser.
3. Use silicon glue on back of dispenser and press the dispenser firmly onto mounting surface by applying pressure to the inside of backplate for 30 seconds. Do not load refill for at least 10 hours.

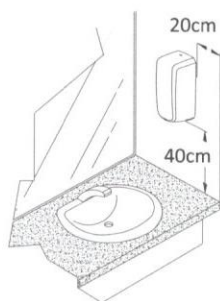

(Fig. 1)

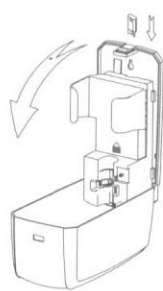

(Fig. 2)

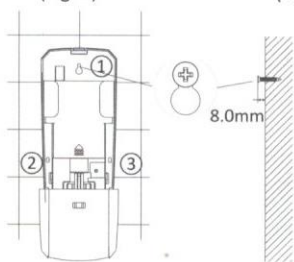

(Fig. 3)

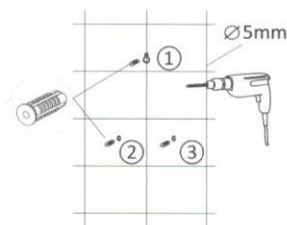

(Fig.4)

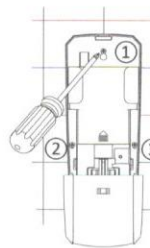

(Fig.5)

7. Remove the Battery cover, load 4 pcs Alkaline C size 1.5V batteries into it, and close battery cover. (Fig. 6)

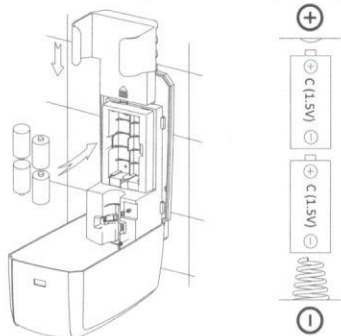

(Fig. 6)

8. Place the refillable tank inside, pull the pump downward and clamp into the groove of the control box. (Fig. 7)

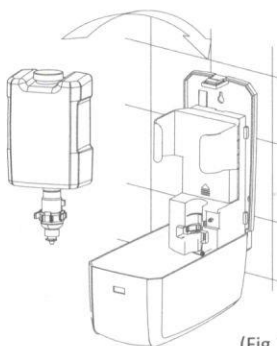

(Fig. 7)

Check point:

- ① The nozzle of the pump must be fixed into the groove of the push rod.
- ② & ③ The pump should be fitted into the groove of the control box.

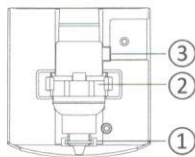

**Note:** Reverse Battery polarities will lead to permanent damage to the dispenser.

#### 4. Operation Instructions:

1. Close the dispenser cover.
2. Place hand below the dispenser. The sensor will activate and the motor will work. If you need more, repeat the movement a few times, must completely move hands out from sensor at this times. (Fig. 8&9)
3. When batteries are low, LED will blinking every 3 seconds.

The dispenser is not working properly at this time. Replace 4 pcs Alkaline C size batteries. Do not mix fresh batteries with old ones.

#### 5. Maintenance Notes:

1. Ensure no bright light source is aimed at the sensor from below.
2. Cleaning should be performed daily with a soft cloth and non-abrasive, no-caustic cleaning fluid. Avoid flusing under unning water, which will cause the electronics to malfunction.
3. The push rod for pump nozzle must be located at the bottom when you install or replace the pump.

◆ **Caution:** The pump should be replaced new one regularly otherwise it may cause a soap leaking and it brings slippery floors. Please check the pump condition and replace new one when the pump's lifespan ends.

#### 6. Troubleshooting:

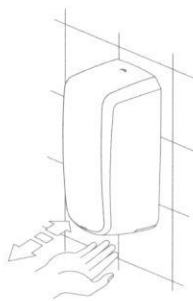

(Fig. 8)

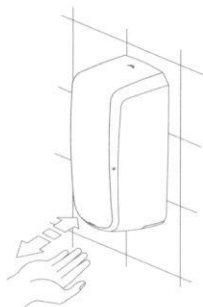

(Fig. 9)

Pump Models

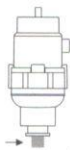

(Blue colored tip)

Gel

Soap liquid

Gel based sanitiser

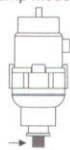

(Green colored tip)

Spray

Liquid sanitiser

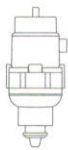

Foam

Foam soap Liquid

Foam based sanitiser



**Note:**

Check your pump type before filling / refilling the solution. Do not mix the solution for ensuring perfect operation.

Problem	Solution
Dispenser cannot work and LED not light.	Check the cover of dispenser properly closed.
	Check batteries, ensure they are new and properly inserted.
	Check sensor cover for stain. Clean unit properly.
	Sensor is activated constantly. Remove the object below the sensor.
LED blinking when unit is not being used.	Check batteries, ensure they are new and properly inserted.
Less amount or leakage of Liquid (or Gel)	Replace a new pump kit.
◇ For all other inquiries call your dealer for technical assistance.	