



Administrator Guide

Yeostar P-Series PBX System

Version: 37.2.0.80

Date: 2021-01-28

-  Support: +86-592-5503301
-  Support: support@yeostar.com
-  <https://www.yeostar.com>

Contents

- About This Guide..... 1**
- Getting Started.....2**
 - Log in to the PBX Web Interface.....2
 - Initial Setup Using the Installation Wizard..... 4
 - Change The Password of Super Administrator..... 6
 - View System Information..... 7
 - Change Web Interface Language.....8
 - Log out of the PBX Web Interface..... 8
- Dashboard..... 9**
 - Dashboard Overview.....9
- Extension.....16**
 - Extension Overview.....16
 - Create Extensions..... 17
 - Create a SIP Extension..... 17
 - Create an FXS Extension..... 18
 - Bulk Create SIP Extensions..... 19
 - Set up Phones..... 21
 - Set up an Analog Phone..... 21
 - Set up a SIP Phone..... 22
 - Set up a Remote SIP Phone.....23
 - Extension Presence..... 25
 - Extension Presence Overview.....25
 - Presence Settings.....26
 - Manually Switch Presence.....29
 - Automatically Switch Presence Based on Business Hours and Holidays.....30
 - Forward Internal and External Calls to Different Destinations.....31
 - Ring Office Phone and Mobile Phone Simultaneously.....32
 - Extension Voicemail.....33
 - Set up Extension Voicemail.....33
 - Extension Features..... 35

Handle Incoming Calls Based on Caller ID.....	35
Set up Email Notifications for Missed Calls.....	36
Set up Email Notifications for User Password Change.....	36
Extension Advanced Settings.....	37
Advanced Settings of SIP Extension.....	37
Advanced Settings of FXS Extension.....	38
Extension Security.....	40
Extension Security Overview.....	40
Restrict Outbound Calls for an Extension.....	41
Restrict Extension Registration Based on User Agent.....	42
Restrict Extension Registration Based on IP Address.....	43
Block Outbound Calls Outside Business Hours.....	43
Limit Call Duration of an Outbound Call.....	44
Manage Extensions.....	44
Edit Extensions.....	44
Export and Import SIP Extensions.....	45
Delete Extensions.....	46
Contacts.....	47
Contacts Overview.....	47
Manage Company Contacts.....	48
Export and Import Company Contacts.....	49
Allow Users to View and Manage Company Contacts.....	50
Identify Callers from Contacts.....	52
Allow Users to Query and Use Contacts on IP Phones.....	54
Extension Group.....	57
Extension Group Overview.....	57
Create an Extension Group.....	58
Manage Extension Groups.....	60
Assign a User Type to a Group Member.....	60
View or Change Permissions for Group Members.....	61
View or Change a Member's User Type in Multiple Groups.....	63
Auto Provisioning.....	65
Auto Provisioning Overview.....	65

Manage Phones.....	66
Auto Provision IP Phones.....	66
Pre-provision IP Phones.....	68
Modify a Provisioned Phone Settings.....	69
Auto Provision Function Keys for Phones.....	70
Reassign an Extension to a Provisioned Phone.....	71
Release an Extension from a Provisioned Phone.....	72
Update Phone Firmware via Auto Provisioning.....	72
Apply a New Template to a Provisioned Phone.....	73
Reboot Provisioned Phones.....	74
Remove Phones from Provisioning List.....	74
Manage Gateways.....	75
Auto Provision Yeastar TA FXS Gateways.....	75
Pre-provision Yeastar TA FXS Gateways.....	77
Modify a Provisioned Gateway Settings.....	79
Reassign an Extension to a Provisioned Gateway.....	80
Release an Extension from a Provisioned Gateway.....	80
Apply a New Template to a Provisioned Gateway.....	81
Reboot Provisioned Gateways.....	81
Remove Gateways from Provisioning List.....	82
Manage Auto Provisioning Tempalte.....	82
View a Default Auto Provisioning Template.....	82
Update a Default Auto Provisioning Template.....	84
Create a Custom Auto Provisioning Template.....	85
Manage Custom Auto Provisioning Template.....	87
Manage Device Firmware.....	88
Manage Device Firmware Files.....	88
Auto Provisioning - Supported Devices.....	89
Auto Provisioning - Variables in Templates.....	92
User Role.....	97
User Roles and Permissions.....	97
Create a User Role.....	98
Assign a Role to a User.....	98

Manage User Roles.....	99
User Role Permissions.....	100
Linkus Server.....	104
Linkus Overview.....	104
Set up Linkus Server with Remote Access Service.....	106
Manually Set up Linkus Server.....	108
Configure Linkus Login Mode.....	112
Enable Linkus Clients for Users.....	112
Configure Linkus Welcome Email.....	113
Send Linkus Welcome Emails.....	114
Enable or Disable Push Notifications for Linkus Mobile Client.....	115
Operator Panel.....	116
Manage Operator Panel.....	116
Trunk.....	118
Trunk Overview.....	118
SIP Trunk.....	121
SIP Trunk Overview.....	121
Create a SIP Trunk.....	122
Manage SIP Trunks.....	128
Export and Import SIP Trunks.....	128
SIP Trunk Settings.....	129
Analog FXO Trunk.....	136
Analog FXO Trunk Overview.....	136
Set up an Analog FXO Trunk.....	137
Release an Analog FXO Trunk.....	138
Analog FXO Trunk Settings.....	138
GSM/3G/4G LTE Trunk.....	141
GSM/3G/4G LTE Trunk Overview.....	141
Set up a GSM/3G/4G LTE Trunk.....	143
GSM/3G/4G LTE Trunk Settings.....	144
ISDN E1/T1 Trunk.....	146
E1/T1/J1 Trunk Overview.....	146
Set up an E1/T1/J1 Trunk.....	147

E1/T1/J1 Trunk Settings.....	148
ISDN BRI Trunk.....	156
BRI Trunk Overview.....	156
Set up a BRI Trunk.....	157
BRI Trunk Settings.....	158
Call Control.....	163
Emergency Calling.....	163
Emergency Calling Overview.....	163
Set up Basic Emergency Calling.....	165
Set up Enhanced Emergency Calling.....	166
Set up a Route for PSAP Callbacks.....	167
Manage Emergency Numbers.....	168
Business Hours and Holidays.....	168
Overview of Business Hours and Holidays.....	168
Global Business Hours.....	170
Holidays.....	178
Inbound Route.....	182
Inbound Route Overview.....	182
Set up an Inbound Route.....	183
Inbound Route Examples.....	185
Manage Inbound Routes.....	202
Export and Import Inbound Routes.....	203
DID Pattern and Caller ID Pattern.....	204
Outbound Route.....	205
Outbound Route Overview.....	205
Set up an Outbound Route.....	206
Manage Outbound Routes.....	208
Export and Import Outbound Routes.....	209
Outbound Dial Pattern.....	210
Dial Pattern Examples.....	213
DID Number.....	214
DID Number Overview.....	214
Configure DID Numbers on a Trunk.....	215

Caller ID.....	217
Caller ID Overview.....	217
Reformat Inbound Caller ID based on a Trunk.....	218
Customize Outbound Caller IDs.....	220
Call Center.....	223
Call Center Overview.....	223
Call Center Setup.....	224
Set up Queue Managers.....	224
Customize Queue Notification.....	224
Grant Queue Panel Permissions.....	225
Set up Service Level Agreement (SLA).....	226
Call Center Report.....	227
Call Center Reports Overview.....	227
Queue Performance reports.....	227
Agent Performance Report.....	230
Call Features.....	235
Voicemail.....	235
Voicemail Overview.....	235
Send and Receive Voicemail Messages.....	236
Manage Voicemail Messages.....	239
Voicemail Security.....	242
Voicemail Greetings.....	244
Voicemail Notifications.....	247
Customer Voicemail Experience.....	250
Global Voicemail Settings.....	252
Voicemail Menu Options.....	253
Voicemail Capacity and Limitations.....	253
IVR.....	254
Interactive Voice Response (IVR) Overview.....	254
Set up an IVR.....	255
Set up IVR Prompts.....	256
Allow Callers to Dial Extensions via IVR.....	258
Allow Callers to Dial by Name via IVR.....	259

Allow Callers to Dial Outbound Calls via IVR.....	260
Forward Incoming Calls to an External Number via IVR.....	260
IVR Configuration Example.....	261
Call Recording.....	265
Call Recording Overview.....	265
Set up Call Recording.....	266
Set up Recording Prompts.....	267
Pause or Resume Call Recording.....	268
Monitor Call Recording Status on an IP phone.....	269
Manage Call Recording Files.....	270
Auto Clean up Recording Files.....	271
Grant Manage Permission of Recording Files.....	272
Ring Group.....	273
Ring Group Overview.....	273
Create a Ring Group.....	274
Manage Ring Groups.....	274
Call Queue.....	275
Call Queue Overview.....	275
Create a Queue.....	276
Manage Call Queues.....	278
Manage Agent Status by Dialing a Feature Code.....	278
Monitor and Switch Agent Status on an IP Phone.....	279
Queue Preferences.....	281
Feature Code.....	284
Configure feature codes.....	284
Feature Code Reference.....	284
Conference.....	286
Conference Overview.....	286
Create a Conference Room.....	286
Join a Conference Call.....	287
Invite Users to a Conference Call.....	288
Manage Conference Rooms.....	288
Conference Voice Menu.....	289

Speed Dial.....	290
Speed Dial Overview.....	290
Set up Speed Dial Prefix.....	290
Add a Speed Dial Number.....	290
Manage Speed Dial Numbers.....	291
Call Transfer.....	292
Call Transfer Overview.....	292
Set up Call Transfer.....	292
Perform an Attended Transfer.....	293
Perform a Blind Transfer.....	293
Call Pickup.....	294
Call Pickup Overview.....	294
Pick up a Call for a Group Member.....	295
Pick up a Call for a Specific Extension.....	296
Call Parking.....	297
Call Parking Overview.....	297
Directed Call Parking.....	298
Call Parking.....	299
Set up Parking Timeout Destination.....	299
Set up Parking Number.....	300
Monitor a Parking Number on an IP Phone.....	300
Fax.....	301
Fax Overview.....	301
Send Faxes from an Analog Fax Machine.....	303
Receive Faxes through a Dedicated Trunk.....	305
Receive Faxes and Calls through the Same Line.....	306
Receive Faxes by Email.....	308
Set up Fax over IP (FoIP).....	309
Intercom.....	310
Intercom Call.....	310
PBX System.....	312
System Preferences.....	312
Voice Prompt.....	313

Voice Prompt Overview.....	313
System Prompt.....	315
Music on Hold.....	316
Custom Prompt.....	319
Convert Audio Files.....	321
Audio Files Requirements.....	322
SIP Settings.....	322
Jitter Buffer.....	327
Jitter Buffer Overview.....	327
Configure Jitter Buffer.....	328
Network.....	329
Basic Network.....	329
Web Server.....	338
Service Ports.....	339
Public IP and Ports.....	340
Static Route.....	349
Date and Time.....	355
Change System Time Manually.....	355
Synchronize System Time with an NTP Server.....	355
Email Server.....	356
Email Server Overview.....	356
Set up Yeastar SMTP Server as an Email Server.....	357
Set up Gmail as an Email Server.....	358
Set up Outlook as an Email Server.....	361
Customize Email Templates.....	363
Email Sent Logs.....	363
Storage.....	364
Storage Overview.....	364
Set up a USB Flash Drive.....	366
Set up a Hard Disk Drive.....	367
Set up an SD Card.....	369
Add a Windows Network Drive.....	370
Add a Mac Network Drive.....	376

Manage Storage Locations.....	381
Auto Cleanup Settings.....	382
Event Notification.....	385
Event Notification Overview.....	385
Configure Event Notifications.....	388
Manage Notification Contacts.....	389
Manage Event Logs.....	390
Security.....	392
Security Overview.....	392
Static Defense.....	393
Add a Static Defense Rule.....	393
Manage Static Defense Rules.....	394
Auto Defense.....	395
Add an Auto Defense Rule.....	395
Manage Auto defense Rules.....	396
Blocked IPs.....	396
Manage Blocked IP Addresses.....	396
Console/SSH Access.....	397
Access the System via SSH.....	397
Certificates.....	399
Upload TLS certificates to the PBX.....	399
Upload HTTPS Certificates to the PBX.....	400
Delete Certificates.....	401
Maintenance.....	402
Upgrade.....	402
Check for Available Firmware Updates.....	402
Schedule Automatic Firmware Upgrade.....	403
Manually Upgrade PBX Firmware.....	404
Backup and Restore.....	405
Overview of Backup and Restore.....	405
Create an On-Demand Backup.....	406
Set up an Automatic Backup Schedule.....	407
Restore Your System from a Backup.....	408

Restore Another System from a Backup.....	409
Reboot.....	410
Reboot the System on Web Interface.....	410
Schedule Automatic Reboot.....	411
Reset.....	411
Reset the System on Web Interface.....	411
Operation Logs.....	412
Operation Logs Overview.....	412
Manage Operation Logs.....	413
Troubleshooting.....	414
Capture Network Packet.....	414
Use IP Ping Tool to Diagnose Network Issues.....	415
Use Traceroute Tool to Diagnose Network Issues.....	416
Troubleshoot and Monitor Analog Ports.....	419
System Logs.....	420
System Logs Overview.....	420
Configure Log Level.....	421
Manage System Logs.....	421
CDR and Reports.....	423
CDR.....	423
Call Detail Record (CDR) Overview.....	423
Manage CDR.....	424
Call Report.....	426
Call Reports Overview.....	426
Call Reports.....	427
Manage Call Reports.....	432
Customize Email Template for Scheduled Reports.....	435
Refereneces.....	437
Import and Export Parameters Overview.....	437
Extension Parameters.....	437
Contacts Parameters.....	443
Trunk Parameters.....	444
Inbound Route Parameters.....	447

Outbound Route Parameters..... 450

About This Guide

In this guide, we describe every detail on the functionality and configuration of the Yeastar P-Series PBX System.

Audience

This guide is for administrators who need to prepare for, configure and operate the PBX system. We begin by assuming that you are familiar with networking and other IT disciplines.

Organization

[Getting Started](#)

[Dashboard](#)

[Extension](#)

[Extension Group](#)

[User Role](#)

[Linkus Server](#)

[Operator Panel](#)

[Trunk](#)

[Call Control](#)

[Call Features](#)

[Call Center](#)

[PBX System](#)

[Security](#)

[Maintenance](#)

[CDR and Reports](#)

Getting Started

Log in to the PBX Web Interface

Yeastar P-Series PBX System provides a web management portal that allows you to quickly set up and manage the system. This topic describes how to log in to the PBX web interface.

Prerequisites

- You have connected the network cable.

Select either of the following two methods to connect network cable.

- # Use a network cable to connect the LAN port of the PBX to the network adapter port of the PC.

- # Use a network cable to connect the LAN port of the PBX to a switch or router, and also connect your PC to the switch or router.

- An operation and maintenance terminal (a PC) is available. The PC must meet the following requirements:

- # Have a web browser installed and Chrome web browser is recommended.

- # Support the resolution of 1366 x 768 or higher.

- You have set the IP address of your PC.

The IP address of the PC must be on the same network segment as that of the PBX and cannot conflict with IP addresses of other devices.

Note:

- # The default IP address of Yeastar P-Series PBX System is 192.168.5.150, and the default gateway address is 192.168.5.1.

- # If you fail to access the PBX web interface, contact your network administrator to check if your PC can communicate with the IP address 192.168.5.150.

Procedure

1. Open the web browser, enter the IP address of the PBX (default: 192.168.5.150) in the address bar, and press **Enter**.

 **Note:** If it is your first time to access the system, you will be redirected to the Installation Wizard.

For more information of Installation Wizard, see [Initial Setup Using the Installation Wizard](#).

2. If a warning appears to remind you that the page is not secure, ignore the warning on the web page, expand the **Advanced** tab, and proceed to the PBX web.



Your connection is not private

Attackers might be trying to steal your information from **192.168.5.150** (for example, passwords, messages, or credit cards). [Learn more](#)

NET::ERR_CERT_AUTHORITY_INVALID

Help improve Chrome security by sending [URLs of some pages you visit](#), limited system information, and some page content to Google. [Privacy policy](#)

[Hide advanced](#) [Back to safety](#)

This server could not prove that it is **192.168.5.150**; its security certificate is not trusted by your computer's operating system. This may be caused by a misconfiguration or an attacker intercepting your connection.

[Proceed to 192.168.5.150 \(unsafe\)](#)

3. Enter the administrator username and password, click **LOG IN**.
- **Username:** The username of administrator account that you configured in the Installation Wizard.
 - **Password:** The password of the administrator account.

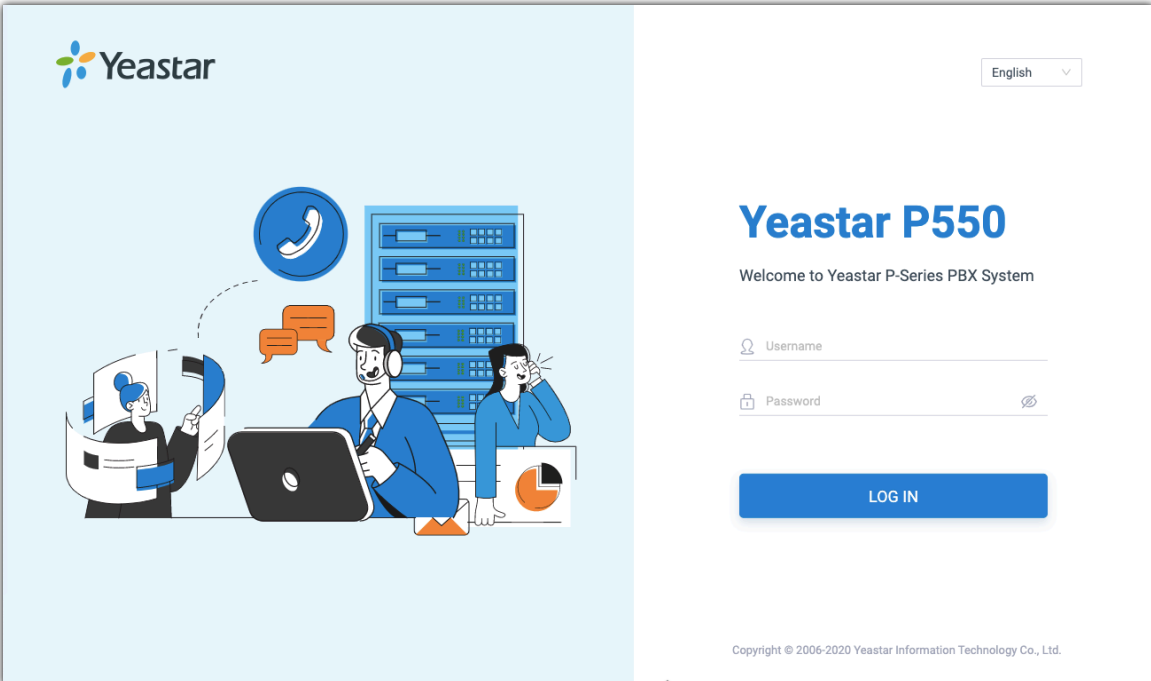

Yeastar

English

Yeastar P550

Welcome to Yeastar P-Series PBX System

Username

Password

LOG IN

Copyright © 2006-2020 Yeastar Information Technology Co., Ltd.

Initial Setup Using the Installation Wizard

When you access the PBX web interface for the first time, you need to finish initial configurations for the system using the Installation Wizard.

Prerequisites

- You have accessed the PBX web interface and entered the Installation Wizard.

How to access the PBX web interface, see [Log in to the PBX Web Interface](#).

 **Warning:** The Installation Wizard only appears when you first configure the system.

Procedure

- [Step1. Configure the system network.](#)
- [Step2. Set up super administrator account.](#)
- [Step3. Configure the system time.](#)
- [Step4. Localize and customize the system.](#)
- [Step5. Check and confirm the configurations.](#)

Step1. Configure the system network

Set the Ethernet mode and related configuration of corresponding Ethernet interface.

1. In the **Basic** section, select the Ethernet mode and default interface.
 - **Ethernet Mode:** Select an Ethernet mode.
 - # **Single:** Only LAN port is used for connection, WAN port is disabled.
 - # **Bridge:** LAN port is used for connection. WAN port will be used as bridge for other device's connection.
 - # **Dual:** Both LAN port and WAN port are used for connection.
 -  **Note:** Dual Ethernet mode is typically for the scenario that the Internet Telephony Service Provider (ITSP) offers a dedicated networking for VoIP communication.
 - **Default Interface:** Optional. Select a default interface if the system is in dual Ethernet mode.
2. In the **LAN** section, enter the network information for the LAN interface of the PBX.
3. **Optional:** In the **WAN** section, enter the network information for the WAN interface of the PBX.
4. Click **Next**.

A pop-up window appears and displays the information of network detection.

For more information of network settings, see [Basic Network Overview](#).

Step2. Set up super administrator account

1. In the **Basic** section, enter the information of the super administrator account.

 **Note:**

- Do NOT forget the username and password of the super administrator account, or you need to reset your system to reconfigure the account and log in to the PBX.
- The super administrator has access to all features on the system, and the super administrator can assign administrator role to users. For more information, see [User Roles and Permissions](#).

- **Username:** Specify the username that is used to log in to the PBX web interface.

- **Password:** Specify the password that is used to log in to the PBX web interface.

- **Repeat the password:** Repeat the password to confirm.

- **Email Address:** Enter the email address of the super administrator.

The email address can be used to receive system notifications.

- **Mobile Number:** Enter the mobile number that can be used to receive system notifications.

- **Prefix:** Optional. Enter the prefix according to the dial pattern of the outbound route, so that the system can successfully send calls to the mobile number.

For more information of the prefix setting, see [Prefix and Dial Pattern](#).

2. In the **Event Notifications** section, configure event notifications for the super administrator.

- **Send Event Notification to PBX Administrator:** Decide whether to enable notifications for the super administrator or not.

- **Contact Name:** Enter the name of the super administrator.

 **Note:** This name helps you identify the super administrator from the Notification Contacts list.

- **Notification Level:** Select which levels of notifications to be received to the super administrator.

- **Notification Method:** Select method(s) to receive notifications.

For more information of event notifications, see [Event Notification Overview](#).

3. Click **Next**.

Step3. Configure the system time

1. In the **Date and Time** section, configure the time zone and daylight saving time, and set up the date and time manually or synchronize with a NTP server.

 **Note:** To synchronize system time with a NTP server, make sure that the PBX can access the Internet.

2. In the **Display Format** section, select the display format for date and time.
3. Click **Next**.

Step4. Localize and customize the system

1. In the **System Prompt Language** section, select the radio button beside a system prompt to set it as the default system prompt.

 **Note:** Click **Download Online Prompts** to download more prompts.

2. In the **Other Settings** section, adjust the following settings for your local installation.
 - **Notification Email Language:** Select which language of email contents to be received.
 - **Device Name:** Specify a name for the PBX system.
 - **Name Display Format:** Select the display format for Extension User's Name and Contact Name.
 - **Tone Region:** Select your country/region or nearest neighboring country/region to enable the default dial tone, busy tone, ring tone and for your region.
3. Click **Next** to see the summary.

Step5. Check and confirm the configurations

1. Check the all the configured settings on the **Summary** page.
2. To edit the configurations of a specific step, click  beside the step title.
3. To edit the configurations of the previous step, click **Re-configure**.
4. If all the configurations are confirmed, click **Reboot** to take effect.

Result

All the configurations take effect after the system reboots.

You need to use access the new IP address of the PBX and log in to the PBX web interface by the super administrator username and password.

 **Note:** The IP address of your PC must be on the same network segment as that of the PBX, or you cannot access the PBX.

Change The Password of Super Administrator

If you know the current password of super administrator, you can log in to the PBX web interface and follow the steps to change your password.

Background information

The username and password of super administrator are configured in [Installation Wizard](#).

Important:

- Remember the username and password, or you need reset the system and reconfigure the username and password.
- The username of super administrator cannot be changed unless you reset the system.

Procedure

1. Log in to the PBX web interface.
2. At the top-right corner of the web page, click  and select **Change Password**.
3. On the pop-up window, enter the old password and new password.
4. Click **Save**.

Result

The password is reset, you will be logged out of the web page automatically. To log in to the PBX web interface, enter the new password.

View System Information

This topic describes how to view a summary of information about your system hardware, firmware and network.

Procedure

1. Log in to the PBX web interface, go to **Dashboard**.
2. At the top-right corner of **Dashboard**, click **Information**.

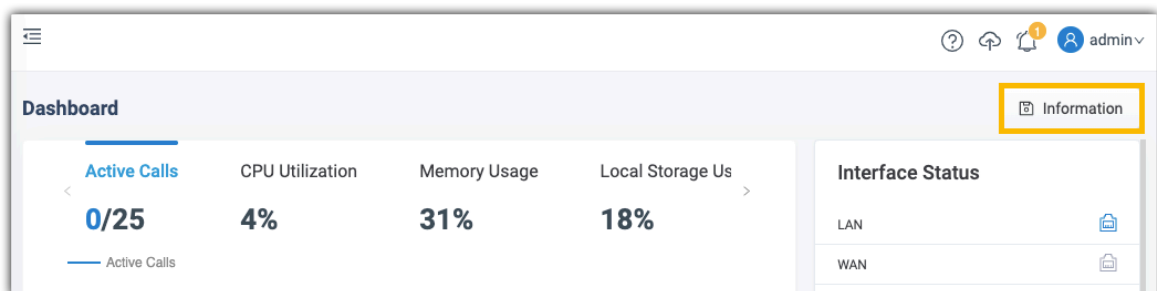

The following information is displayed:

- Network details
- Device Name
- Product Model
- Serial Number
- Hardware Version

- Firmware Version
- System Time
- Uptime
- Maximum Extensions
- Maximum Concurrent Calls

Change Web Interface Language

The default web interface language of Yeastar P-Series PBX System is English, the interface can be easily switched to the language of your choice.

Procedure

1. Log in to the PBX web interface.
2. At the top-right corner of the web page, click .
3. Select **Language** and select your desired language.

The web interface is switched to the selected language immediately.

Log out of the PBX Web Interface

When you're ready to quit the Yeastar P-Series PBX System, simply close the web page or follow the steps below to log out the PBX web interface.

Procedure

1. At the top-right corner of the web page, click .
2. Select **Log out**.

Related information

[Change Automatic Logout Time](#)

Dashboard

Dashboard Overview

Yeastar P-Series PBX System Dashboard gives you a historical and real-time view of what is happening on the PBX. This topic describes all the widgets on the Dashboard.

Yeastar P-Series PBX System Dashboard provides 6 widgets to help you monitor system performance in real time, and allows you to quickly access specific PBX features by simple click on headings.

The supported 6 widgets are as follows:

- System performance
- System information
- Plan
- System interface
- System status
- Event trend

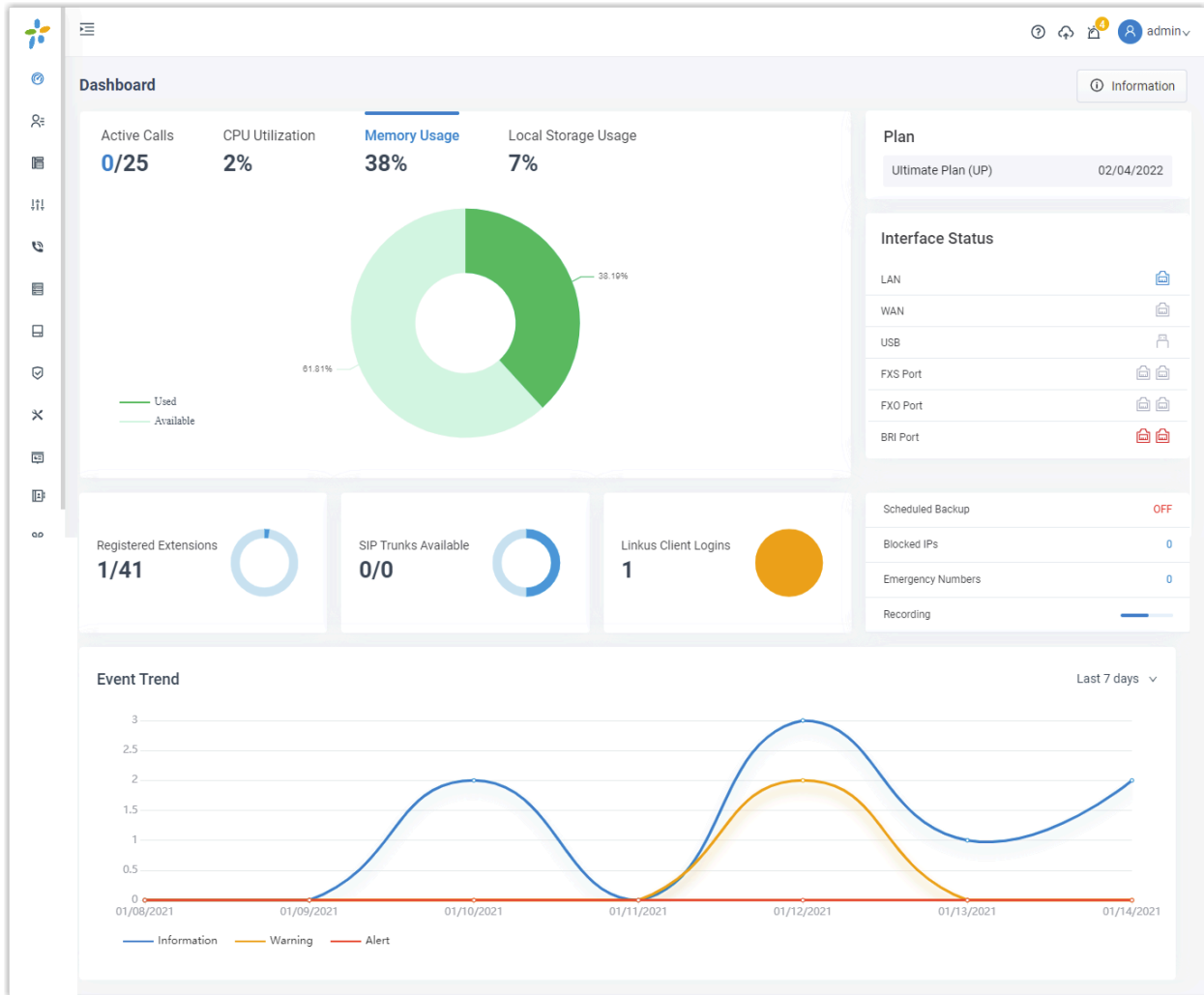

1. [System performance](#)
2. [System information](#)
3. [Plan](#)
4. [System interface](#)
5. [System status](#)
6. [Event trend](#)

System performance

System performance displays the following information:

- **Active Calls:** The real-time and the supported concurrent calls.
- **CPU Utilization:** The PBX's CPU usage.
- **Memory Usage:** The PBX's memory usage.
- **Local Storage Usage:** Usage of the PBX's local storage.

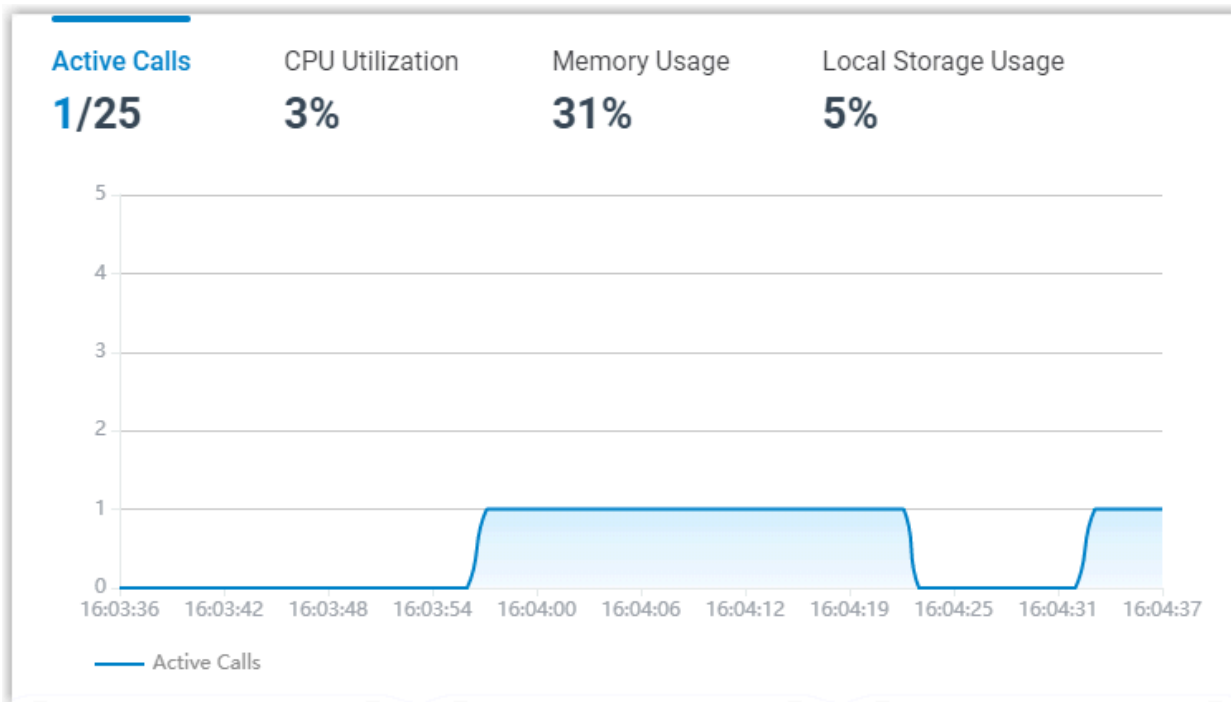

System information

Click **Information** at the top-right corner. System information displays the PBX's network information and basic information.



Yeastar

Yeastar Information Technology Co., Ltd.

×

Network

LAN >

Information

Device Name	PBX
Product Model	Yeastar P550
Serial Number	3631A2124788
Hardware Version	V1.00 0000-0000
Firmware Version	37.1.0.3
System Time	09/18/2020 11:10:02 Fri
Uptime	01:31:56
Maximum Extensions	50
Maximum Concurrent Calls	25

Plan

Plan displays your subscribed plan and expiration date.

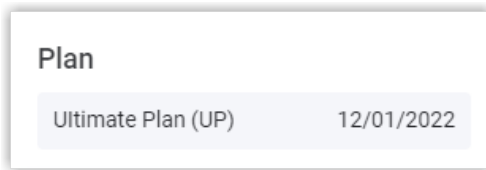

If PBX loses connection to Yeastar License Activation Server, the following status may be displayed:

- **Connecting:** The system is trying to connect to the License Activation Server.
- **Abnormal:** The system failed to connect to the License Activation Server.

System interface

System interface displays connection status of interfaces on Yeastar P-Series PBX System.

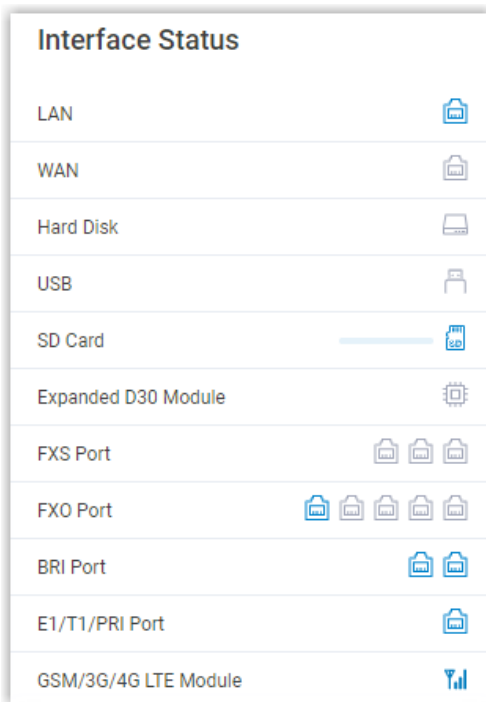

Table 1.



Interface	Description
LAN	<ul style="list-style-type: none"> • : Connected. • : Disconnected.
WAN	<ul style="list-style-type: none"> • : Connected.

Table 1. (continued)







































Interface	Description
	<ul style="list-style-type: none"> : Disconnected.
Hard Disk	<ul style="list-style-type: none"> : Connected. : Not inserted. : Connected, but the hard disk is "Read Only" or encounters format error. : Connected, but the hard disk is formatting. <p> Note: Hard Disk is ONLY supported on P560 and P570.</p>
USB	<ul style="list-style-type: none"> : Connected. : Not inserted. : Connected, but the USB flash drive is "Read Only" or encounters format error. : Connected, but the USB flash drive is formatting.
SD Card	<ul style="list-style-type: none"> : Connected. : Not inserted. : Connected, but the SD card is "Read Only" or encounters format error. : Connected, but the SD card is formatting. <p> Note: SD card is ONLY supported on P560 and P570.</p>
Expanded D30 Module	<ul style="list-style-type: none"> : Connected. : Not connected. : Connected, but the D30 module is abnormal. <p> Note: D30 module is ONLY supported on P560 and P570.</p>
FXS port	<ul style="list-style-type: none"> : An extension number is assigned to the FXS port. : No extension number is assigned to the FXS port.
FXO port	<ul style="list-style-type: none"> : A PSTN line is connected to the FXO port. : No PSTN line is connected to the FXO port. : Abnormal. : Busy.
BRI port	<ul style="list-style-type: none"> : Available.

Table 1. (continued)

Interface	Description
	<ul style="list-style-type: none"> • : Unavailable. • : Abnormal.
E1/T1/PRI port	<ul style="list-style-type: none"> • : Available. • : Unavailable. • : Abnormal.
GSM/3G/4G LTE module	<ul style="list-style-type: none"> • : Abnormal. • : No SIM card is inserted. • : The module is powered off. • : No signal. • : PIN/PUK error. • : Network registration failure. • : Different signal strength when the trunk is busy. • : Different signal strength when the trunk is idle.

System status

System status displays the following information:

- **Registered Extensions:** The number of registered extensions and created extensions.
- **SIP Trunks Available:** The number of available trunks and created trunks.
- **Linkus Client Logins:** The number of Linkus clients where users has logged.
- **Scheduled Backup:** Whether scheduled backup feature is enabled or not. If enabled, the system displays the last time when a backup file was created.
- **Blocked IPs:** Display the following information:
 - # The number of IP address and account that were blocked by the PBX.
 - # The last time when an IP address or an account was blocked by the PBX.
- **Emergency Numbers:** The number of created emergency numbers.
- **Recording:** How much storage space for recording has been used.

 **Note:** If it displays "Undefined Storage Location", it means that you haven't specified a storage location for recording files.

Registered Extensions 4/160	SIP Trunks Available 3/3	Linkus Client Logins 0	Scheduled Backup ON 10/06/2020 22:03:33
			Blocked IPs 0
			Emergency Numbers 2
			Recording —

Event trend

Event trend provides historical and real-time view of system events. You can track frequency of events that were triggered during the last 7 days, 15 days, or 30 days.

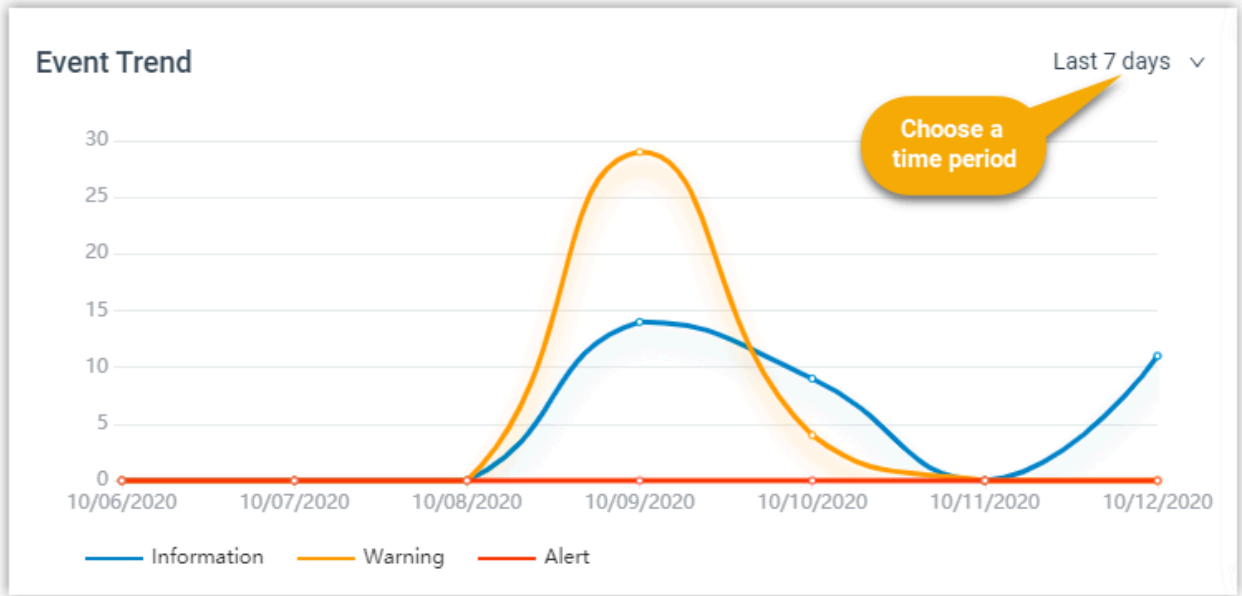

Extension

Extension Overview

An extension is a short internal number. Extensions allow users to make and receive calls. You can assign extensions to every employee in your organization.

Extension types

Yeastar P-Series PBX System supports two extension types:

SIP extension

A SIP extension is based on SIP protocol.

To use a SIP extension to make or receive calls, you need to register the extension on an IP phone or a softphone.

For more information, see [Create a SIP Extension](#) and [Set up a SIP Phone](#).

FXS extension

An FXS extension is associated with an analog phone or a fax machine.

To use an FXS extension to make or receive calls, you need to connect an analog phone or a fax machine to PBX's FXS port, and assign an extension number to the analog phone or fax machine.

For more information, see [Create an FXS Extension](#) and [Set up an Analog Phone](#).

Online status

Online status allows you to view status of phone endpoints and Linkus clients.

• Phone endpoints

 indicates that the SIP extension is registered and ready for use.

 indicates that the FXS extension is assigned to an FXS port.

• Linkus clients

 indicates that Linkus Desktop Client is ready for use.

 indicates that Linkus Mobile Client is ready for use.

 indicates that Linkus Web Client is ready for use.

Create Extensions

Create a SIP Extension

This topic describes how to create a SIP extension and configure relevant settings.

Procedure

1. Log in to the PBX web interface, go to **Extension and Trunk > Extension**, click **Add** and select **Add**.
2. In the **Basic** section, select **SIP Extension** from the drop-down list of **Extension Type**.
3. In the **User Information** section, configure user information as follows:
 - **First Name:** Enter the user's first name.
 - **Last Name:** Enter the user's last name.
 - **Email Address:** Enter the user's email address. The user can receive voicemail messages or PBX notifications via the email address.

 **Note:** An email address is exclusive to a user.

- **Mobile Number:** Enter the user's mobile number. The user can receive calls or PBX notifications on this mobile number.
- **User Password:** Enter a user password. The user can use the password to log in to Linkus clients.

 **Note:** The password is randomly generated by default. To change user password, a minimum of 10 characters with number, upper case, and lower case are required.

- **User Role:** Assign a role to the user to determine which outbound route is available for the user to make outbound calls, and whether the user can manage specific PBX features.
The default value is **None**, which means that the user can not manage specific PBX features.

 **Note:** The system has default user roles with [pre-configured permissions](#). You can also [Create a User Role](#).

4. In the **Extension Information** section, configure extension information as follows:
 - **Extension Number:** Enter an extension number.
 - **Caller ID:** Enter a caller ID number. The caller ID will be displayed on the callee's device.
 - **Registration Name:** Enter a name that is used to register the SIP extension. The default registration name is randomly generated.
 - **Registration Password:** Enter a password that is used to register the SIP extension. The default registration password is randomly generated.

 **Note:** For security reasons, we recommend that you set a strong password.

5. **Optional:** Click other tabs to configure other settings according to your needs.
6. Click **Save** and **Apply**.

Result

The SIP extension is created.

What to do next

- To set up a SIP phone in your local network, see [Set up a SIP Phone](#).
- To set up a SIP phone remotely, see [Set up a Remote SIP Phone](#).

Create an FXS Extension

This topic describes how to create an FXS extension and configure relevant settings.

Prerequisites

You have installed an S2 module or SO module on the PBX.

Procedure

1. Log in to the PBX web interface, go to **Extension and Trunk > Extension**, click **Add** and select **Add**.
2. In the **Basic** section, configure basic settings of the extension as follows:
 - a. In the **Extension Type** drop-down list, select **FXS Extension**.
 - b. In the **FXS Port** drop-down list, select an FXS port.
3. In the **User Information** section, configure user information as follows:
 - **First Name:** Enter the user's first name.
 - **Last Name:** Enter the user's last name.
 - **Email Address:** Enter the user's email address. The user can receive voicemail messages or PBX notifications via the email address.

 **Note:** An email address is exclusive to a user.

- **Mobile Number:** Enter the user's mobile number. The user can receive calls or PBX notifications on this mobile number.
- **User Password:** Enter a user password. The user can use the password to log in to Linkus clients.

 **Note:** The password is randomly generated by default. To change user password, a minimum of 10 characters with number, upper case, and lower case are required.

- **User Role:** Assign a role to the user to determine which outbound route is available for the user to make outbound calls, and whether the user can manage specific PBX features.

The default value is **None**, which means that the user can not manage specific PBX features.

 **Note:** The system has default user roles with [pre-configured permissions](#). You can also [Create a User Role](#).

4. In the **Extension Information** section, configure extension information as follows:
 - **Extension Number:** Enter an extension number.
 - **Caller ID:** Enter a caller ID number. The caller ID will be displayed on the callee's device.
5. **Optional:** Click other tabs to configure other settings according to your needs.
6. Click **Save** and **Apply**.

Result

The FXS extension is created.

What to do next

[Connect an analog phone to the FXS port.](#)

Bulk Create SIP Extensions

This topic describes how to bulk create SIP extensions.

Procedure

1. Log in to the PBX web interface, go to **Extension and Trunk > Extension**, click **Add** and select **Bulk Add**.
2. Configure basic settings for the extensions as follows.
 - a. In the **Basic** section, select **SIP Extension** from the drop-down list of **Extension Type**.

- b. In the **User Information** section, configure user information as follows:
 - **Start Extension Number:** Enter the start extension number.

The system will bulk create extensions starting with the extension number.

- **Create Number:** Enter the number of extensions that will be created.

 **Note:** Only an integer ranging from 1 to 999 is allowed.

- **User Password:** Choose a password type.

 **Important:** Set a password that contains a minimum of 10 characters with number, upper case, and lower case.

Generate Randomly: Password will be randomly generated for each extension.

Prefix + Extension Number: If you choose the type, enter a prefix in the **Password Prefix** field.

Extension Number + Suffix: If you choose the type, enter a suffix in the **Password Suffix** field.

Fixed Password: If you choose the type, enter a fixed password in the **Fixed Password** field.



- **User Role**: Assign a role to the extensions to determine which outbound route is available for the users to make outbound calls, and whether these users can manage specific PBX features.

The default value is **None**, which means that these users can not manage specific PBX features.

 **Note**: The system has default user roles with [pre-configured permissions](#). You can also [Create a User Role](#).

- c. In the **Extension Information** section, configure extension registration information as follows.

- **Registration Name**: Choose how to configure registration name.
 - # **Generate Randomly**: Registration name will be randomly generated for each extension.
 - # **Prefix + Extension Number**: If you choose the type, enter a prefix in the **Name Prefix** field.
 - # **Extension Number + Suffix**: If you choose the type, enter a suffix in the **Name Suffix** field.
 - # **Fixed Name**: If you choose the type, enter a fixed name in the **Fixed Name** field.
 - # **Extension Number**: If you choose the type, extension number will be the registration name of each extension.
- **Registration Password**: Choose a password type.

 **Note**: For security reasons, we recommend that you set a strong password. If you set weak passwords for these extensions,  will be displayed in front of these extensions on **Extension** page.

Generate Randomly: Password will be randomly generated for each extension.

Prefix + Extension Number: If you choose the type, enter a prefix in the **Password Prefix** field.

Extension Number + Suffix: If you choose the type, enter a suffix in the **Password Suffix** field.

Fixed Password: If you choose the type, enter a fixed password in the **Fixed Password** field.

3. **Optional**: Click other tabs to configure other settings for the extensions.

- **Presence**: Configure presence settings.
- **Voicemail**: Turn on **Enable Voicemail**, choose a password type from the drop-down list of **Voicemail PIN Authentication**.

 **Tip**: Configure [voicemail notifications and play options](#) according to your needs.

Generate Randomly: A PIN code will be randomly generated for each extension.

Prefix + Extension Number: If you choose the type, enter a prefix in the **PIN Prefix** field.

Extension Number + Suffix: If you choose the type, enter a suffix in the **PIN Suffix** field.

Fixed Password: If you choose the type, enter a PIN code in the **Fixed PIN Code** field.

Extension Number: If you choose the type, extension number will be set to PIN code for each extension.

Disabled: No PIN code is required when accessing voicemails.

- **Features:** Configure email notifications, time-conditional presence auto switch, call handling rules, and call recording.
- **Advanced:** Configure advanced settings.
- **Security:** Configure SIP security settings and call restriction settings.
- **Linkus Clients:** Enable Linkus clients for the extensions.
- **Function Keys:** Provision function keys.

When the extensions are bound with phones through auto provisioning, the function keys associated with the extensions will be applied to phones.

4. Click **Save** and **Apply**.

Result

The extensions are created. The system prompts you the number of created extensions, and the associated extension numbers.

What to do next

- To set up a SIP phone in your local network, see [Set up a SIP Phone](#).
- To set up a SIP phone remotely, see [Set up a Remote SIP Phone](#).

Set up Phones

Set up an Analog Phone

This topic describes how to set up an analog phone.

Prerequisites

- You have [created an FXS extension](#).
- You have prepared an analog phone and a RJ11 cable.

Procedure

1. Connect one end of the RJ11 cable to the analog phone; connect the other end to the FXS port to which you have assigned an FXS extension.
2. Check indicator of the FXS port that is connected to the analog phone.

Result

If the indicator displays solid green, it means that the analog phone is ready for use. Users can use the analog phone to make and receive calls.

Set up a SIP Phone

This topic describes how to register a SIP extension on a SIP phone in the local network.

Prerequisites

- You have [created a SIP extension](#).
- The SIP phone is in the same local network as Yeastar P-Series PBX System.

Procedure

1. Gather information of extension registration.
For most SIP phones, the following credentials are needed in order to register with Yeastar P-Series PBX System.
 - The PBX's IP address
 - SIP registration port (Path: **System > Network > Service Ports**)
 - Transport protocol (Path: **Extension and Trunk > Extension > Advanced > Transport**)
 - Extension information (Path: **Extension and Trunk > Extension > User**):
 - # Extension number
 - # Registration name
 - # Registration password
 - # Caller ID name
2. Register the extension on a phone.
Log in to the phone's web interface, fill in and save the required items to register the SIP extension.
3. Confirm the extension's registration status in one of the following ways:
 - On the phone's web interface, check if the extension is registered.
 - Log in to the PBX web interface, go to **Extension and Trunk > Extension**, check if the endpoint icon displays  in the **Online Status** column.

Result

The SIP phone is ready for use. Users can use the SIP phone to make and receive calls.

Set up a Remote SIP Phone

This topic provides a configuration example to help you understand how to register a remote SIP extension on a SIP phone.

Background information

Yealink T56A and Yeastar P-Series PBX System are in different locations and networks. The administrator wants to register Yealink T56A on Yeastar P-Series PBX System, so that users in branch office can use Yealink T56A to make and receive calls.

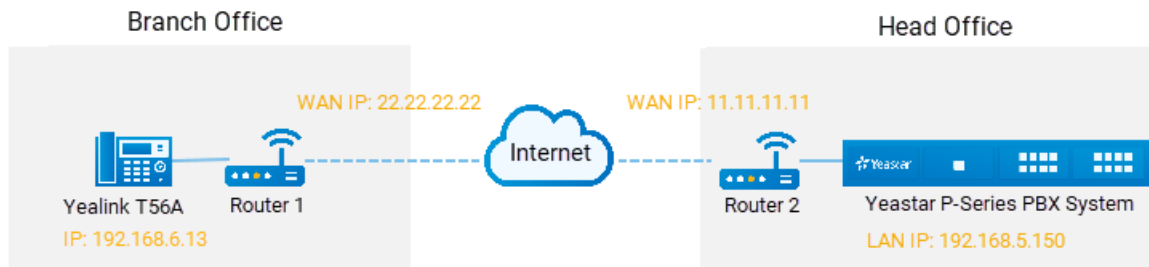

Procedure

- [Step1. Forward the required ports on your router](#)
- [Step2. Configure SIP NAT settings on your PBX](#)
- [Step3. Set up an extension for remote access](#)
- [Step4. Register the extension on the phone](#)

Step1. Forward the required ports on your router

Forward the following ports on Router 2 that is connected to Yeastar P-Series PBX System, so that all the packets received on the router WAN port (11.11.11.11) can be forwarded to the PBX (192.168.5.150).

Table 2.

Service port	Local port	External port
SIP Registration Port	UDP 5060	UDP 5078
RTP Ports Range	UDP 10000-12000	UDP 10000-12000

Step2. Configure SIP NAT settings on your PBX

Configure SIP NAT settings to ensure that SIP data can be transmitted correctly between the PBX and the public Internet.

Procedure

1. Log in to the PBX web interface, go to **System > Network**, click **Public IP and Ports** tab.
2. Turn on the option **Public IP (NAT)**, and configure NAT settings.
 - a. In the **NAT Type** drop-down list, select **Public IP Address**.
 - b. In the **Public IP address** field, enter the PBX's WAN IP. In this example, enter *11.11.11.11*.
 - c. In the **Local Network Identification** section, enter the local network segment and subnet mask.
 - i. Click **+Add IP**.
 - ii. In the **Network Number** field, enter the LAN IP. In this example, enter *192.168.5.0*.
 - iii. In the **Subnet Mask** field, enter the subnet mask. In this example, enter *255.255.255.0*.
 - d. In the **NAT Mode** drop-down list, select **Yes**.

The PBX uses NAT, ignores the address information in the SIP headers or SDP headers, and replies to the sender's IP address and port.
3. Enter external ports that you have forwarded on the router 2.
 - **External SIP UDP Port**: In this example, enter *5078*.
4. Click **Save** and **Apply**.

Step3. Set up an extension for remote access

1. On the PBX web interface, go to **Extension and Trunk > Extension**, edit the desired extension.
2. Click **Security** tab, select the checkbox of **Allow Remote Registration**.
3. Click **Save** and **Apply**.

Step4. Register the extension on the phone

Log in to the phone web interface to register the desired extension on Yealink T56A.

 **Note:** Use the public IP address of the PBX and the forwarded SIP port to register the remote extension.

Account	Account 2	?
Register Status	Registered	
Line Active	Enabled	?
Label	1000	?
Display Name	1000	?
Register Name	ALVLqoWE95	?
User Name	1000	?
Password	?
SIP Server 1	?	
Server Host	11.11.11.11	Port 5078 ?
Transport	UDP	?
Server Expires	3600	?
Server Retry Counts	3	?

Public IP of Yeastar IPPBX

The forwarded SIP port

Result

Users in branch office can use Yealink T56A to make and receive calls.

Extension Presence

Extension Presence Overview

This topic describes what is extension presence and how presence benefits a user's work.

What is presence

Presence indicates a user's current status. By default, anyone in your organization using Yeastar P-Series PBX System can see if other users are available.

Yeastar P-Series PBX System supports the following status:

- **Available:** The user is online and ready for communication.
- **Away:** The user is away from desk.
- **Business Trip:** The user is on a business trip.
- **Do Not Disturb:** The user doesn't want to be disturbed, and he or she won't receive any calls.
- **Lunch Break:** The user is currently on lunch break.
- **Off Work:** The user is currently off work.

How presence benefits a user's work

Presence is associated with the following settings. You can configure the following settings for each presence. When a user's presence changes, the following settings will change accordingly.

- **Presence information:** Details about current presence.
- **Call forwarding:** Route internal and external calls to different destinations based on extension presence.
- **Ring strategy:** Adjust endpoints' ring strategy based on extension presence.
- **Ring timeout:** Adjust endpoints' ring timeout based on extension presence except **Do Not Disturb** status.
- **Ring the Mobile Number Simultaneously:** Whether to simultaneously ring mobile phone when a call reaches the extension number.
- **Accept push notifications:** Whether to receive Linkus push notifications on Linkus Mobile Client, such as missed calls, voicemails, etc.
- **Agent Status Auto Switch:** Adjust agent status automatically if the user is in a queue.
- **Voicemail greetings:** Adjust voicemail greetings based on extension presence.

For more information, see [Presence Settings](#) and [Change Voicemail Greetings](#).

Presence switch

There are two ways to switch extension presence:

- **Switch presence manually:** Extension users can switch their own presence on Linkus clients; an administrator can also switch extension presence for specific users on PBX web interface.

For more information, see [Switch Presence on Linkus Client](#) and [Switch Presence on PBX Web Interface](#).

- **Switch presence automatically:** Presence is switched based on [Business Hours and Holidays](#).

For more information, see [Auto Switch Presence Status based on Business Hours and Holidays](#).

Presence Settings

This topic describes presence settings.

Background information

Yeastar P-Series PBX System supports to configure presence settings under each presence for all the users. When a user's presence changes, presence settings will change accordingly.

Log in to the PBX web interface, go to **Extension and Trunk > Extension**, edit the desired extension in the **Presence** tab.

- [Presence Information](#)
- [Call Forwarding](#)
- [Ring Strategy](#)
- [Ring Timeout](#)
- [Options](#)

Presence Information

Table 3.

Setting	Description
Presence Information	Add a note to the current presence. The note will be displayed on Linkus clients.

Call Forwarding

Call forwarding rules help forward incoming calls to a specific destination when the user is unavailable. You can set different destinations for incoming calls based on extension presence.

Table 4.

Setting	Description
Types of incoming calls	<ul style="list-style-type: none"> • Internal Calls: Set a call forwarding rule for incoming calls from colleagues. • External Calls: Set a call forwarding rule for incoming calls from external users.
Forwarding condition	<p>Select a forwarding condition and configure a destination.</p> <ul style="list-style-type: none"> • Always: Forward all incoming calls to the designated destination. • No Answer: Only forward unanswered calls to the designated destination. • When Busy: Only forward the calls that come in while the user is talking on the phone to the designated destination.

Ring Strategy

Ring strategy allows you to decide in which order incoming calls are distributed to the endpoints where the user's extension is registered.

- **Extension Endpoint:** The IP phone, softphone, or analog phone to which the user's extension has logged in.
- **Linkus Mobile Client**

- Linkus Desktop Client (Softphone Only)
- Linkus Web Client

Table 5.

Setting	Description
Ring First	Set which endpoint will ring first.
Ring Secondly	Set which endpoint will ring secondly.

Ring Timeout

To prevent callers from waiting for a long time, you can configure ring timeout. If the call is not answered during the time period, it will be routed to the destination of **No Answer**.

Table 6.

Setting	Description
Ring Timeout	Enter a value or select a value from the drop-down list.  Note: The valid range is from 5 to 300.

Options

Ring the Mobile Number Simultaneously

To simultaneously ring both extension and the associated mobile number when anyone calls in the extension number, you can configure a simultaneous ring strategy.

 **Note:** The feature is unavailable in **Do Not Disturb** status.

Table 7.

Setting	Description
Ring the Mobile Number Simultaneously	Check the option to enable this feature, and configure the user's mobile number.
Prefix	Enter the prefix of outbound route so that PBX can successfully send calls out.

Accept Push Notifications

By default, the user can receive push notifications on Linkus Mobile Client anywhere and anytime, such as missed calls, new voicemail messages and so on. If Linkus server is set up only in local network, in case the user can not connect to calls when he or she is out of the office, you can disable push notifications for the user.

Table 8.

Setting	Description
Accept Push Notification	Enable or disable push notifications on Linkus Mobile Client.

Agent Status Auto Switch

If the user is a dynamic agent who needs to frequently log in to or out of a queue, you can associate queue status with extension presence. The user's status in a queue will automatically change along with his or her extension presence.

Table 9.

Setting	Description
Login	Log in to a queue.  Note: The option is available ONLY in Available status.
Logout	Log out of a queue.
Pause	Pause receiving queue calls.
Do Nothing	Retain current status.

Manually Switch Presence

This topic describes how to switch an extension's presence manually.

Procedure

1. Log in to the PBX web interface, go to **Extension and Trunk > Extension**.
2. On **Extension** list, find the desired extension.
3. In the **Presence** column, select a status from the drop-down list.

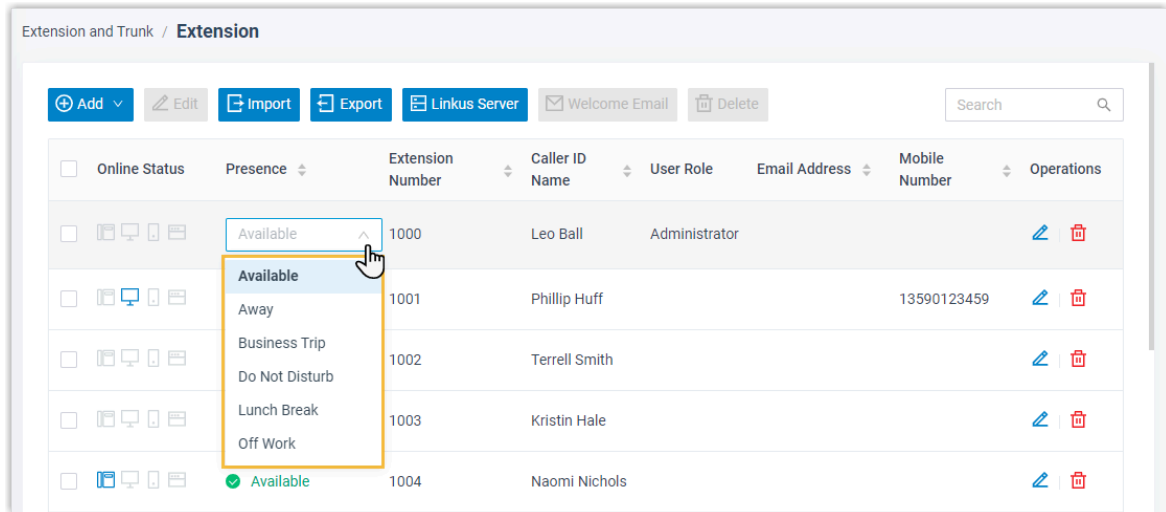

4. On the current page, click a blank space.
5. Click **Apply**.

Result

New presence is synchronized on Linkus clients; [presence settings](#) related with the status take effect.

Related information

[Automatically Switch Presence Based on Business Hours and Holidays](#)

Automatically Switch Presence Based on Business Hours and Holidays

This topic gives a configuration example to describe how to configure presence auto switch based on Business Hours and Holidays for specific extension users.

Background information

Assume that you have set Business Hours and Holidays on the PBX system, and you want the presence of extensions to be automatically switched according to the following time schedule:

Business Hours and Holidays	Time-based Presence
Business Hours: 09:00-12:00 and 14:00-18:00 from Monday to Friday.	Available
Break Hours: 12:00-14:00 from Monday to Friday.	Lunch Break
Holidays: December 25 to January 5.	Off Work
Outside Business Hours: The time periods that are not defined as Business Hours, Break Hours, or Holidays.	Off Work

Procedure

1. Log in to the PBX web interface, go to **Extension and Trunk > Extension**, edit the extensions that need to switch presence status automatically based on the time schedule.
2. Click the **Features** tab, and go to **Time-conditional Presence Auto Switch** section.
3. Configure the following presence based on the time:
 - **Business Hours**: Select a status to be displayed during office hours.
In this scenario, select **Available**.
 - **Break Hours**: Select a status to be displayed during break time.
In this scenario, select **Lunch Break**.
 - **Holidays**: Select a status to be displayed during holiday.
In this scenario, select **Off Work**.
 - **Outside Business Hours**: Select a status to be displayed during non-office hours.
In this scenario, select **Off Work**.
4. Click **Save**.

 **Note:** The priority of presence switching at different times is: **Holidays > Break Hours > Business Hours > Outside Business Hours**.

Result

Presence status will be switched automatically according to the Business Hours and Holiday status.

For example, after 18:00, the presence displayed on Linkus client will be switched to **Off Work**.

 **Note:** If someone force switches Business Hours Status, the presence will be switched according to the current Business Hours status.

For example, Business Hours status is switched from **Outside Business Hours** to **Business Hours**, the presence will be switched from **Off Work** to **Available**.

Related information

[Overview of Business Hours and Holidays](#)
[Manually Switch Presence](#)

Forward Internal and External Calls to Different Destinations

This topic describes how to forward internal and external calls to different destinations.

Scenario

A boss is in a meeting, and he or she only wants to receive calls from secretary. In this case, you can route external calls to a destination like voicemail, and internal calls to the secretary's extension.

Procedure

1. Log in to the PBX web interface, go to **Extension and Trunk > Extension**, edit the desired extension.
2. Click **Presence** tab.
3. In the status bar, select a status to which the call forwarding rule will be applied.
4. In the **Internal Calls** section, select a forwarding action and specify a destination.

In this example, select the checkbox of **Always**, set the destination to **Extension**, and select the secretary's extension.

5. In the **External Calls** section, select a forwarding action and specify a destination.

In this example, select the checkbox of **Always**, set the destination to **Voicemail**.

6. Click **Save** and **Apply**.

Result

When a call reaches the extension number, the system will check the user's presence, identify whether it originates from an internal caller or external caller, and then route the call to the specified destination.

Ring Office Phone and Mobile Phone Simultaneously

This topic describes how to achieve simultaneous ring on office phone and mobile phone.

Scenario

A user may miss important calls when he or she is away from desk or on a business trip. In this case, you can enable simultaneous ring for the user. When a call reaches the user's extension number, both mobile phone and office phone with the extension number logged in will simultaneously ring.

Prerequisites

- You have set a mobile number for the extension.
- At least one outbound route is ready for use.

Procedure

1. Log in to the PBX web interface, go to **Extension and Trunk > Extension**, edit the desired extension.

2. Click **Presence** tab.
3. In the status bar, select a status to which the strategy of simultaneous ring will be applied.
4. In the **Options** section, configure the following settings.
 - a. Select the checkbox of **Ring the Mobile Number Simultaneously**.
 - b. Click  to configure mobile number.
 - c. **Optional:** In the **Prefix** field, enter the [prefix of outbound route](#) so that PBX can successfully send calls to your phone.
 - If the **Strip** of outbound route is not set, you don't have to set the **Prefix**.
 - If the **Strip** of outbound route is set, you need to set the **Prefix** according to the **Patterns** of outbound route.
5. Click **Save** and **Apply**.

Result

If a call reaches the user's extension number when he or she is in the specified presence, both office phones and mobile phone will ring simultaneously.

Extension Voicemail

Set up Extension Voicemail

This topic introduces voicemail feature and describes how to set up voicemail for an extension.

Background information

Yeastar P-Series PBX System supports voicemail feature, which helps users receive audio messages when they are unavailable to answer calls. When you create an extension, the voicemail feature is enabled by default, and a 4-digit PIN code is randomly generated for accessing voicemail.

You can retain default settings, or change the following settings according to your needs.

- [Enable or disable voicemail feature](#)
- [Voicemail PIN Authentication](#)
- [Notification methods and play options of voicemails](#)
- [Voicemail greetings](#)

Procedure

1. Log in to the PBX web interface, go to **Extension and Trunk > Extension**, edit the desired extension.
2. Click **Voicemail** tab, turn on the option **Enable Voicemail**.

3. **Optional:** Configure voicemail PIN settings.

- **Voicemail PIN Authentication:** Set whether a PIN code is required when the user accesses voicemail.
 - # **Enabled**
 - # **Disabled**
- **Voicemail Access PIN:** Retain the default PIN code or change it according to your needs.

 **Note:** The PIN code must be number, and the length must be 3-15 digits.

4. **Optional:** Configure notification settings for new voicemails.

- **New Voicemail Notification:** Set whether to notify the user or not when receiving a new voicemail, and how to notify.
 - # **Do not Send Email Notifications:** Disable email notification.
 - # **Send Email Notifications with Attachment:** Send a notification email with the new voicemail message attached as a .wav file.
 - # **Send Email Notifications without Attachment:** Send a notification email as soon as receiving a new voicemail message in mailbox.
- **After Notification:** Set how to deal with voicemails after sending emails to inform the user.
 - # **Make as Read:** Keep the voicemail messages in mailbox as read to prevent users from repeatedly receiving reminders on their phone.
 - # **Delete Voicemail:** Delete the voicemail message to avoid mailbox being filled up.

 **Note:** We recommend that you choose this option only when the extension user has received a notification email with voicemail message attachment.

Do Nothing: Keep the voicemail messages in mailbox as unread.

5. **Optional:** Set whether to play the following messages when playing a voicemail.

- **Play Date and Time**
- **Play Caller ID**
- **Play Message Duration**

6. **Optional:** To customize voicemail greetings that will be played to callers when they reach the user's voice mailbox, see [Record or Upload Voicemail Greetings](#).

7. Click **Save** and **Apply**.

Related information

- [Forward Voicemail Messages to Email](#)
- [Check Voicemail Messages](#)

Extension Features

Handle Incoming Calls Based on Caller ID

This topic describes how to create a call handling rule for a specific user to handle incoming calls (calls from colleagues and external contacts) based on incoming Caller ID.

Procedure

1. Log in to the PBX web interface, go to **Extension and Trunk > Extension**, edit the desired extension.
2. Click **Features** tab.
3. In the **Call Handling Based on Caller ID** section, set up one or more rules according to your needs.
 - a. Click **Add**.
 - b. In the **Caller ID** field, enter a specific number or a number pattern.
 - To apply the rule to a specific number, enter a specific number.
For example, enter *10086* to handle incoming calls with Caller ID 10086 based on the rule.
 - To apply the rule to a number pattern, enter a wildcard pattern.
For example, enter *9011!* to handle incoming calls with any Caller ID starting with 9011 based on the rule.
For more information, see [Caller ID Pattern](#).
 - c. In the **Action** drop-down list, set how to deal with incoming calls with the Caller ID.
 - **Hang Up**
 - **Extension**
 - **Voicemail**
 - **IVR**
 - **Play Greeting then Hang up**
 - **Accept Call**

 **Note:** By default, all incoming calls are allowed to reach the extension. If there is a call-handling rule to prevent spam calls (eg.728373XX) from reaching the extension, but the extension user wants to accept calls from a specific number (eg.72837300), you can create another rule to accept calls from 72837300.
 - d. Click **Save**.
 - e. **Optional:** To add more rules, repeat **step a-d**.
 - f. **Optional:** In the **Move** column, adjust the rules' order. The rules take effect from the top down.

 **Note:** For example, set the rule "accept calls from 72837300" to a higher priority than the rule "reject calls from numbers starting with 728373". In this

way, when receiving calls from 72837300, the system will send calls to extension user. For incoming calls from number starting with 728373, the system will hang up directly.

4. Click **Save** and **Apply**.

Result

When incoming calls reach the extension, the system will handle the calls based on Caller IDs.

Set up Email Notifications for Missed Calls

To remind an extension user of missed calls, you can set up email notifications of missed calls for the extension user.

Prerequisites

- [System email server](#) is set up.
- An email address is associated with a desired extension.

Procedure

1. Log in to the PBX web interface, go to **Extension and Trunk > Extension**, edit the desired extension in the **Features** tab.
2. In the **Notifications** section, select the checkbox of **Send email notifications on missed calls**.
3. Click **Save** and **Apply**.

Result

If the extension user has missed calls, system will send notification emails to the user's mailbox.

Set up Email Notifications for User Password Change

To remind an extension user of user password change, you can set up email notifications of user password change for the extension user.

Prerequisites

- [System email server](#) is set up.
- An email address is associated with a desired extension.

Procedure

1. Log in to the PBX web interface, go to **Extension and Trunk > Extension**, edit the desired extension in the **Features** tab.
2. In the **Notifications** section, select the checkbox of **Send email notification when the User Password is changed**.
3. Click **Save** and **Apply**.

Result

If the extension user's user password has been changed, system will send notification emails to the user's mailbox.

Extension Advanced Settings

Advanced Settings of SIP Extension

This topic describes the advanced settings of a SIP extension.

 **Note:** The SIP configurations require professional knowledge of SIP protocol. Incorrect configurations may cause calling issues on the SIP extension.

Table 10.



Setting	Description
DTMF Mode	<p>Set the mode for sending DTMF tones.</p> <ul style="list-style-type: none"> • RFC4733 (RFC2833): DTMF will be carried in the RTP stream in different RTP packets. • Info: DTMF will be carried in the SIP info messages. • Inband: DTMF will be carried in the audio signal. • Auto: If the device supports RFC4733 (RFC2833), PBX will choose RFC4733 (RFC2833), otherwise the PBX will choose Inband.
Transport	<p>Set the transport protocol.</p> <ul style="list-style-type: none"> • UDP • TCP • TLS <p> Note: If you change the transport protocol, you must re-register the extension.</p>
Qualify	<p>Enable this option to send SIP OPTION packet to SIP device to check if the device is up.</p>
T.38 Support	<p>Enable or disable T.38 fax for the extension.</p>

Table 10. (continued)

Setting	Description
	 Note: Enabling T.38 will add performance cost. We recommend that you disable T.38.
SRTP	Enable SRTP for voice encryption.

Advanced Settings of FXS Extension



This topic describes the advanced settings of an FXS extension.

 **Note:** The FXS configurations require professional knowledge. Incorrect configurations may cause calling issues on the FXS extension.

VoIP settings

If you enable Linkus clients for an FXS extension, you may need to configure the following settings:



Table 11.

Setting	Description
DTMF Mode	Set the mode for sending DTMF tones. <ul style="list-style-type: none"> • RFC4733 (RFC2833): DTMF will be carried in the RTP stream in different RTP packets. • Info: DTMF will be carried in the SIP info messages. • Inband: DTMF will be carried in the audio signal. • Auto: If the device supports RFC4733 (RFC2833), PBX will choose RFC4733 (RFC2833), otherwise the PBX will choose Inband.
Transport	Set the transport protocol. <ul style="list-style-type: none"> • UDP • TCP • TLS  Note: If you change the transport protocol, you must re-register the extension.
Qualify	Enable this option to send SIP OPTION packet to SIP device to check if the device is up.
T.38 Support	Enable or disable T.38 fax for the extension.  Note: Enabling T.38 will add performance cost. We recommend that you disable T.38.
SRTP	Enable SRTP for voice encryption.

Hotline

Hotline feature allows a phone to automatically dial a pre-configured number when the user goes off hook and a specific time interval passes.

Table 12.

Setting	Description
Hotline	Turn on the option to enable hotline feature.
Hotline Number	Enter the hotline number.  Note: Only numbers, space, and () . - + * # are allowed.
Delay Dial (s)	Enter the waiting time (in seconds) before automatically dialing out the hotline number.  Note: Only numbers are allowed.

Flash Detection

Set an amount of time to help the PBX identify if a hook flash is a valid event.

Table 13.

Setting	Description
Min Flash Detection (ms)	Set the minimum amount of time. The default value is 300. To change the value, select a value from the drop-down list. Valid values: 100, 200, 300, 400, 500, 600, 700, 800, 900, 1000
Max Flash Detection (ms)	Set the maximum amount of time. The default value is 1000. To change the value, select a value from the drop-down list. Valid values: 100, 200, 300, 400, 500, 600, 700, 800, 900, 1000

Volume Settings

Set the transmitted and received volume of PBX.

Table 14.



Setting	Description
RX Volume	Set the volume from the analog phone to the PBX's FXS port. The default value is 40%. To change the value, select a value from the drop-down list. Valid values: 5%, 10%, 20%, 40%, 60%, 80%, 100%, 150%, Custom  Note: If you choose Custom , you must go to RX Gain (db) field to enter an integer between -30 and 12.

Table 14. (continued)

Setting	Description
TX Volume	<p>Set the volume from the PBX's FXS port to the analog phone. The default value is 40%.</p> <p>To change the value, select a value from the drop-down list.</p> <p>Valid values: 5%, 10%, 20%, 40%, 60%, 80%, 100%, 150%, Custom</p> <p> Note: If you choose Custom, you must go to TX Gain (db) field to enter an integer between -30 and 12.</p>

Options

Table 15.

Setting	Description
Call Waiting	When receiving an incoming call during an active call, the user can hear a weak beeping sound that informs the user of the new incoming call. The user can press FLASH key on the analog phone to toggle between incoming call and the current call.
DTMF Passthrough	If this option is enabled, PBX will not process the DTMF tones, and pass DTMF tones transparently to the other end.
Echo Cancellation	If this option is enabled, PBX removes extra noise and improves sound quality during a call.

Extension Security

Extension Security Overview

This topic describes security options to prevent Yeastar P-Series PBX System from unauthorized SIP registrations and abused outbound calls.

SIP security options

Yeastar P-Series PBX System provides the following options to prevent unauthorized SIP registrations.

Allow Remote Registration

Anytime you use a remote extension to access PBX, you expose your PBX to the public internet, which increases the risk of VoIP hacking and attack. The option is disabled by default.

 **Note:** We recommend that you keep the option disabled unless you need a remote extension.

SIP User Agent Identification

By default, PBX allows phones to register extensions without user agent limit. To enhance extension security, you can restrict which user agent is allowed to register an extension.

When a phone is trying to register the extension, the phone will send SIP packets containing user agent. If the prefix of the user agent does not match the specified value, the registration will fail.

SIP Registration IP Restriction

By default, PBX allows SIP registrations without the limit of IP address.

To enhance extension security, you can specify which IP address or IP section is allowed to register an extension.

Call restrictions options

Yeastar P-Series PBX System provides the following options to prevent abused outbound calls.

Disable Outbound Calls

Restrict users from making outbound calls.

Disable Outbound Calls outside Business Hours

Restrict users from making outbound calls during off-duty time and holidays.

Max Outbound Call Duration (s)

When the user is in an outbound call and the call duration reaches the limit, the system would end the call.

Restrict Outbound Calls for an Extension

This topic describes why and how to restrict outbound calls for an extension.

Background information

Toll fraud is a global problem in telecommunication industry. It happens when hackers access your PBX system and make expensive phone calls from existing accounts. To prevent toll fraud, you can restrict outbound calls for an extension.

Procedure

1. Log in to the PBX web interface, go to **Extension and Trunk > Extension**, edit the desired extension.
2. Click **Security** tab.
3. In the **Call Restrictions** section, select the checkbox of **Disable Outbound Calls**.
4. Click **Save** and **Apply**.

Result

The user can NOT make outbound calls except emergency call like 911.

On Extension list,  is displayed in front of the extension.

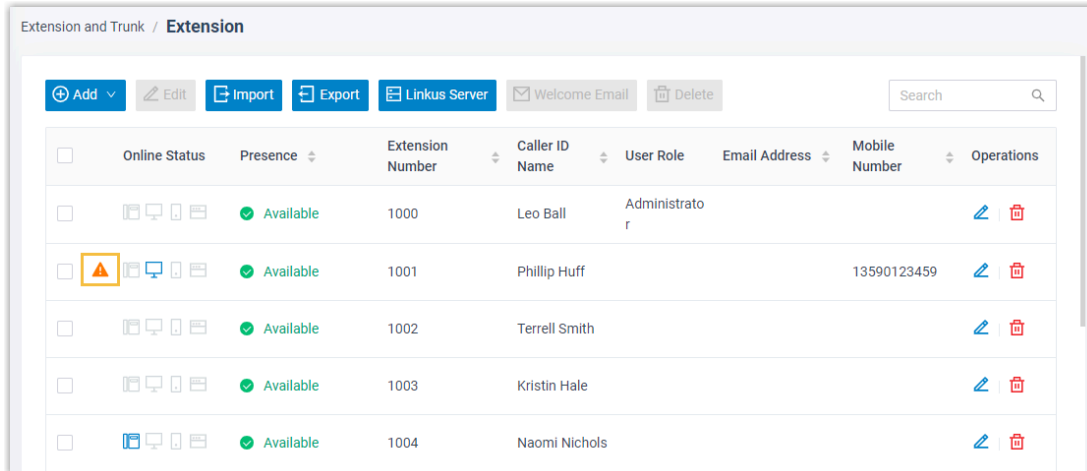

<input type="checkbox"/>	Online Status	Presence	Extension Number	Caller ID Name	User Role	Email Address	Mobile Number	Operations
<input type="checkbox"/>			1000	Leo Ball	Administrator			
<input type="checkbox"/>			1001	Phillip Huff			13590123459	
<input type="checkbox"/>			1002	Terrell Smith				
<input type="checkbox"/>			1003	Kristin Hale				
<input type="checkbox"/>			1004	Naomi Nichols				

Restrict Extension Registration Based on User Agent

This topic describes how to restrict extension registration based on user agent.

Background information

SIP is a peer-to-peer protocol. The peers in a session are called User Agents (UAs). A user agent can play one of the following roles:

- User Agent Client (UAC): A client application that initiates a SIP request, such as INVITE, ACK, OPTIONS, BYE, CANCEL, and REGISTER.
- User Agent Server (UAS): A server application that receives the SIP request from a UAC, and returns a response to the request back to the UAC.

When a SIP endpoint tries to register an extension to Yeastar P-Series PBX System, the SIP endpoint working as UAC sends packets containing user agent string to the PBX, which works as UAS. By default, Yeastar P-Series PBX System allows registration from any UAC without authenticating user agent. For security reasons, you can restrict extension registration based on user agent.

Procedure

1. Log in to the PBX web interface, go to **Extension and Trunk > Extension**, edit the desired extension.
2. Click **Security** tab.
3. In the **SIP Security** section, select the checkbox of **Enable User Agent Registration Authorization**.

4. Set the user agent.
 - a. Click **Add User Agent**.
 - b. In the **User Agent** field, enter a value.
5. Click **Save** and **Apply**.

Result

When a phone is trying to register an extension, the phone will send SIP packets containing a user agent, such as phone manufacturer, phone model, etc. If the prefix of the user agent does not match the specified value, the registration will fail.

Restrict Extension Registration Based on IP Address

This topic describes how to allow devices with a specific IP address or in a specific IP section to register extensions on Yeastar P-Series PBX System.

Background information

By default, Yeastar P-Series PBX System allows SIP registrations without the limit of IP address. In case hackers remotely register extensions and make expensive phone calls, you can restrict that only devices with a specific IP address or in a specific IP section can register extensions on Yeastar P-Series PBX System.

Procedure

1. Log in to the PBX web interface, go to **Extension and Trunk > Extension**, edit the desired extension.
2. Click **Security** tab.
3. In the **SIP Security** section, select the checkbox of **Enable IP Restriction**.
4. Set which IP address or IP section is allowed to register the extension.
 - a. Click **Add IP**.
 - b. In the **Permitted IP** and **Subnet Mask** fields, set the allowed IP address or IP section.
5. Click **Save** and **Apply**.

Result

Only device with the IP address or in the IP section can register the extension.

Block Outbound Calls Outside Business Hours

This topic describes how to restrict an extension from making outbound calls outside business hours.

Prerequisites

You have set [global business hours](#).

Procedure

1. Log in to the PBX web interface, go to **Extension and Trunk > Extension**, edit the desired extension.
2. Click **Security** tab.
3. In the **Call Restrictions** section, select the checkbox of **Disable Outbound Calls outside Business Hours**.
4. Click **Save** and **Apply**.

Result

The user can NOT make outbound calls during off-duty time and holidays.

Limit Call Duration of an Outbound Call

This topic describes how to limit call duration of an outbound call.

Procedure

1. Log in to the PBX web interface, go to **Extension and Trunk > Extension**, edit the desired extension.
2. Click **Security** tab.
3. In the **Call Restrictions** section, select a value from the drop-down list of **Max Outbound Call Duration (s)**, or enter a value according to your needs.
4. Click **Save** and **Apply**.

Result

When the user is in an outbound call and call duration reaches the **Max Outbound Call Duration (s)**, the system would end the call.

Manage Extensions

Edit Extensions

This topic describes how to edit an extension, or edit extensions in bulk.

Edit an extension

1. Log in to the PBX web interface, go to **Extension and Trunk > Extension**.
2. On **Extension** list, select the desired extension, click .
3. Change extension settings according to your needs.
4. Click **Save** and **Apply**.

Bulk edit extensions

1. Log in to the PBX web interface, go to **Extension and Trunk > Extension**.
2. On **Extension** list, select the checkboxes of the desired extensions, click **Edit**.
3. Select the checkbox of the desired feature, change extension settings according to your needs.
4. Click **Save** and **Apply**.

Export and Import SIP Extensions

The SIP extensions configured on Yeastar P-Series PBX System can be exported and saved as a template. You can fill in desired extension information in the exported file, and import the file to PBX again. This topic describes how to export and import SIP extensions.

 **Note:** Only system super administrator can import SIP extensions.

Export all extensions

You can export all the SIP extensions to a CSV file, and then make additions, removals, and changes to the file.

1. Log in to the PBX web interface, go to **Extension and Trunk > Extension**.
2. Click **Export**.

A CSV file is saved to your computer. To check and edit parameters in the CSV file, see [Extension Parameters](#).

Import SIP extensions

We recommend that you export extension data to a CSV file first, and use the file as a template to start with. In this way, you can save time and effort.

Prerequisites

Requirements of an imported file:

- **Format:** UTF-8 .CSV
- **Size:** Less than 50MB
- **File name:** Less than 127 characters
- **Import parameters:** Ensure that the import parameters meet requirements. For more information, see [Extension Parameters](#).

Procedure

1. Log in to the PBX web interface, go to **Extension and Trunk > Extension**.
2. Click **Import**.
3. In the pop-up window, click **Browse**, select your CSV file.

4. Click **Upload**.

The extension data in the CSV file will be displayed in the **Extension** list.

Delete Extensions

This topic describes how to delete an extension or delete extensions in bulk.

Delete an extension

1. Log in to the PBX web interface, go to **Extension and Trunk > Extension**.
2. On **Extension** list, select the desired extension, click .
3. In the pop-up dialog box, click **OK**.
4. Click **Apply**.

Bulk delete extensions

1. Log in to the PBX web interface, go to **Extension and Trunk > Extension**.
2. On **Extension** list, select the checkboxes of the desired extensions, click **Delete**.
3. In the pop-up dialog box, click **OK**.
4. Click **Apply**.

Contacts

Contacts Overview

Yeastar Contacts feature allows users to store external contacts outside of your organization on PBX, access and call those contacts on endpoints (IP phone and Linkus clients) where their extensions have registered. This topic describes prerequisites, types, key features, and limits of Yeastar Contacts feature.

Prerequisites

To use Contacts feature, make sure Yeastar P-Series PBX System and Linkus clients meet the following requirements:

Table 16.

Product		Requirement
Yeastar P-Series PBX System		Version 37.2.0.80 or later.
Linkus clients	Linkus iOS Client	Version 3.6.8 or later.
	Linkus Android Client	Version 3.6.9 or later.
	Linkus Windows Desktop	Version 2.4.8 or later.
	Linkus Mac Desktop	Version 2.4.8 or later.
	Linkus Web Client	No requirement.

Contacts types

Personal Contacts

Personal Contacts is a directory exclusive to each extension user, which allows users to store a number of external contacts, such as direct customers.

 **Note:** Each user's Personal Contacts is only visible to himself or herself.

Company Contacts

Company Contacts is a directory that can be shared among authorized users. Authorized users can store a number of external contacts, such as company's customers, resellers, and partners.

 **Note:** By default, only system super administrator can view and manage company contacts. System super administrator can grant permissions to users according to users' job duties. For more information about how to grant permissions, see [Allow Users to View and Manage Company Contacts](#).

Key features

Sync contacts on IP phones and Linkus clients

- On IP phones, users can view contacts.
- On Linkus clients, users can view and manage contacts.

Changes of contacts will be synchronized on each Linkus client and IP phone.

Identify incoming calls

When receiving an incoming call from a contact whose information is saved in Personal Contacts or Company Contacts, callee's phone screen will display the contact name. By knowing who is calling, users can handle calls efficiently.

For more information, see [Identify Callers from Contacts](#).

Contacts limits

The following table shows the maximum number of contacts supported on Yeastar P-Series PBX System.

Table 17.

Contacts type	P550	P560	P570
Company contacts (total)	50,000	200,000	500,000
Personal contacts (per extension)	100	200	300

Manage Company Contacts

This topic describes how to add, edit, or delete company contacts.

Prerequisites

Only system super administrator and authorized users can manage company contacts.

 **Note:** To grant Company Contacts permissions to users, see [Allow Users to View and Manage Company Contacts](#).

Add a company contact

1. Log in to the PBX web interface, go to **Contacts**.
2. Add a company contact.
 - a. On the **Contacts** page, click **Add**.

b. Enter contact information.

 **Note:** Contact name (either **First Name** or **Last Name**) and at least one number are required.

c. Click **Save**.

The contact is stored in Company Contacts and synchronized to users' endpoints (IP phones and Linkus clients).

Edit a company contact

1. Log in to the PBX web interface, go to **Contacts**.
2. Edit a company contact.
 - a. On the **Contacts** page, click  beside the desired contact.
 - b. Edit contact information.
 - c. Click **Save**.

Changes of the contact are synchronized to users' endpoints (IP phones and Linkus clients).

Delete company contacts

1. Log in to the PBX web interface, go to **Contacts**.
2. Delete company contacts according to your needs.
 - To delete a company contact, select the desired contact, click  and **OK**.
 - To delete company contacts in bulk, select the checkboxes of the desired contacts, click **Delete** and **OK**.

The contacts are removed from Company Contacts and users' endpoints (IP phones and Linkus clients).

Export and Import Company Contacts

The company contacts configured on Yeastar P-Series PBX System can be exported and saved as a template. You can fill in desired contacts in the exported file, and import the file to PBX again. This topic describes how to export and import company contacts.

 **Note:** Only system super administrator can import company contacts.

Export company contacts

You can export all company contacts to a CSV file, and then make additions, removals, and changes to the file.

1. Log in to the PBX web interface, go to **Contacts**.
2. Click **Export**.

A CSV file is saved to your computer. To check and edit parameters in the CSV file, see [Company Contacts Parameters](#).

Import company contacts

We recommend that you export company contacts data to a CSV file first, and use the file as a template to start with. In this way, you can save time and effort.

Prerequisites

Requirements of an imported file:

- **Format:** UTF-8 .CSV
- **Size:** Less than 300MB
- **File name:** Less than 127 characters
- **Import parameters:** Ensure that the import parameters meet requirements. For more information , see [Company Contacts Parameters](#).

Procedure

1. Log in to the PBX web interface, go to **Contacts**.
2. Click **Import**.
3. In the pop-up window, click **Browse**, and select your CSV file.
4. Click **Import**.

The company contacts in the CSV file will be displayed in the **Contacts** list.

Allow Users to View and Manage Company Contacts

By default, all the users have no access to Company Contacts. This topic describes how to allow users to view and manage company contacts.

Background information

You can control users' access to Company Contacts based on users' user types:

- **View Company Contacts**
- **Manage Company Contacts (Add, Edit, Delete Company Contact)**

This topic describes how to grant permissions to group managers and group members.

 **Note:** If you want to grant permissions to a specific user, you can assign a custom user type to the member, and customize permissions. For more information, see [Assign a custom user type to a group member](#).

Procedure

1. Log in to the PBX web interface, go to **Extension and Trunk > Extension Group**.
2. Select an extension group, click .
3. Click **Group Permissions** tab, configure the permissions in the **Permission Configuration** section.
 - a. Select the checkboxes of corresponding permissions for **Manager** user type in the group.

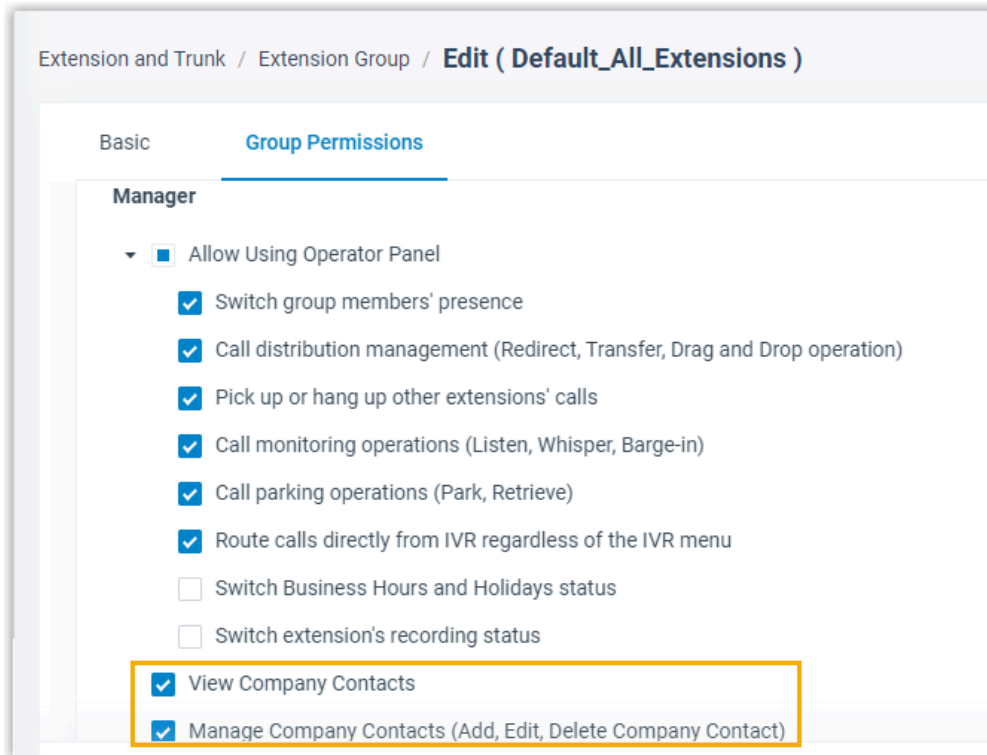

- b. Select the checkboxes of corresponding permissions for **User** user type in the group.

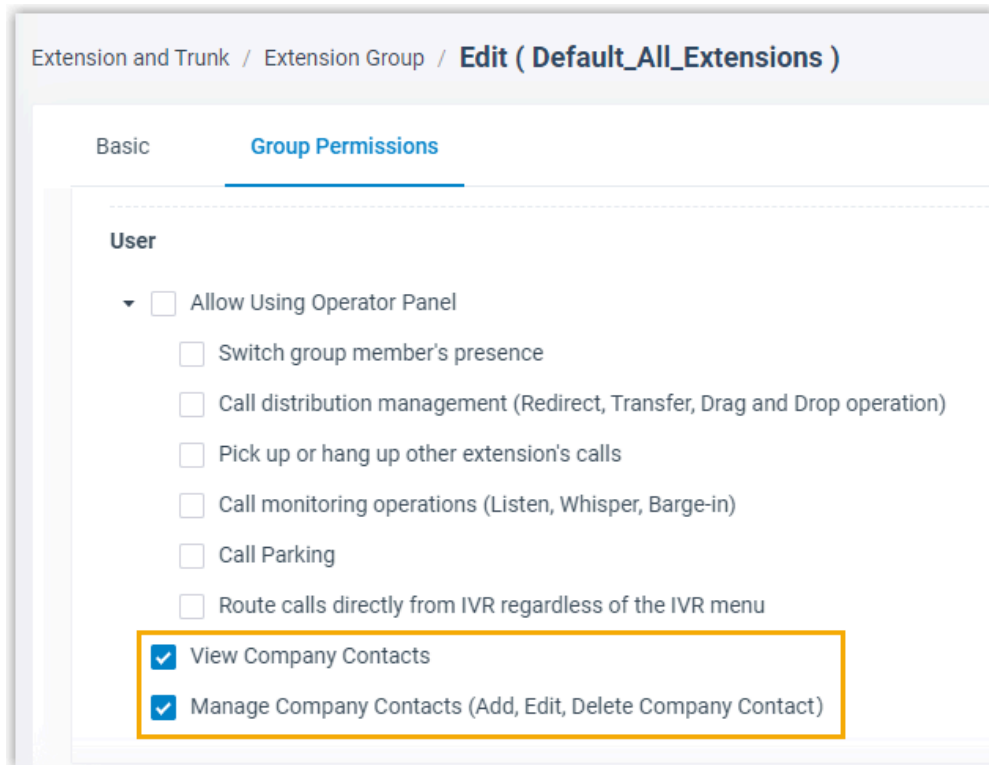

4. Click **Save**.

Result

The permissions are granted to all the managers and users in the group in a batch.

What to do next

If you want to change members' user types to **Manager** or **User** in the group, see [Assign a default user type to a group member](#).

Identify Callers from Contacts

This topic describes how to configure Caller ID match to help users identify callers whose information is stored in Company Contacts or Personal Contacts.

Background information

Caller ID match is supported on all kinds of endpoints, including Linkus clients, desk phones, or softphones. Yeastar P-Series PBX System allows users to identify callers from Company Contacts and Personal Contacts.

Identify callers from Company Contacts

Support for authorized extension users who have permissions to view or manage company contacts.

For more information about how to grant permissions to users, see [Allow Users to View and Manage Company Contacts](#).

Identify callers from Personal Contacts

Support for each extension user.

Priority of Caller ID match

If an incoming number is stored in Company Contacts, Personal Contacts, mobile phone directory, and IP phone directory at the same time, the priority of Caller ID match from high to low is as follows:

- IP phone directory
- Mobile phone directory
- Personal Contacts
- Company Contacts

Configure Caller ID match

Only the system super administrator can configure the Contacts options.

1. Log in to the PBX web interface, go to **Contacts**.
2. Configure Caller ID match.
 - a. On the **Contacts** page, click **Options**.
 - b. Choose how to match incoming Caller ID.
 - **Do Not Match**: Display original incoming Caller ID.
 - **Exact Match**: Display contact name when an incoming Caller ID exactly matches existing number.
 - **Fuzzy matching the last *{number}* digits**: Display contact name when the last few digits of an incoming Caller ID matches that of existing number.
 - c. Click **Save**.

Caller ID match example

A contact Dora whose phone number is 12345678 is stored in Company Contacts; the system receives an incoming call from Dora.

- **Do Not Match** is selected:
 - # When Dora calls in, the contact name "Dora" will not be displayed.
- **Exact Match** is selected:
 - # If the incoming Caller ID is 12345678, the contact name "Dora" will be displayed.
 - # If the incoming Caller ID is +012345678, the contact name "Dora" will NOT be displayed.
- **Fuzzy matching the last 8 digits** is configured:

- # If the incoming Caller ID is +012345678, the contact name "Dora" will be displayed.
- # If the incoming Caller ID is 62345678, the contact name "Dora" will NOT be displayed.

Allow Users to Query and Use Contacts on IP Phones

To allow users to query and use Contacts on IP phones, you need to auto provision IP phones. This topic describes how to allow users to query and use Contacts on IP phones.

Requirements

PBX Server

Version 37.2.0.80 or later.

IP Phone

Use Yealink phones of the required model and version. For more information, see [Yealink Phones](#).

Note:

- VP59, W80B, W60B, W90DM, CP960, and CP920 are not supported.
- A maximum of 1000 company contacts and 300 personal contacts can be displayed on an Yealink phone.

Procedure

1. To allow users to access Company Contacts, you need to grant Company Contacts permission to users.

 **Note:** By default, all the users have access to their own Personal Contacts, but no access to shared Company Contacts.

For more information, see [Allow Users to View and Manage Company Contacts](#).

2. Synchronize contacts data to users' IP phones via Auto Provisioning.
 - If users' extensions haven't be associated with phones, see [Auto Provision IP Phones](#) to bind phones with the extensions.
 - If users' extensions have been associated with phones, reprovision the phones to take effect.
 - a. Go to **Auto Provisioning > Phones**.
 - b. Select the checkboxes of the desired phones, click **Reprovision**.

Result

Contacts data are synchronized to IP phones' remote phonebooks. Users can query and place calls to contacts from the remote phonebook.

Example: Query contacts on Yealink T56A IP phone

1. Tap  > **Remote Phonebook**.

The directories that the user is allowed to view are displayed on the page.

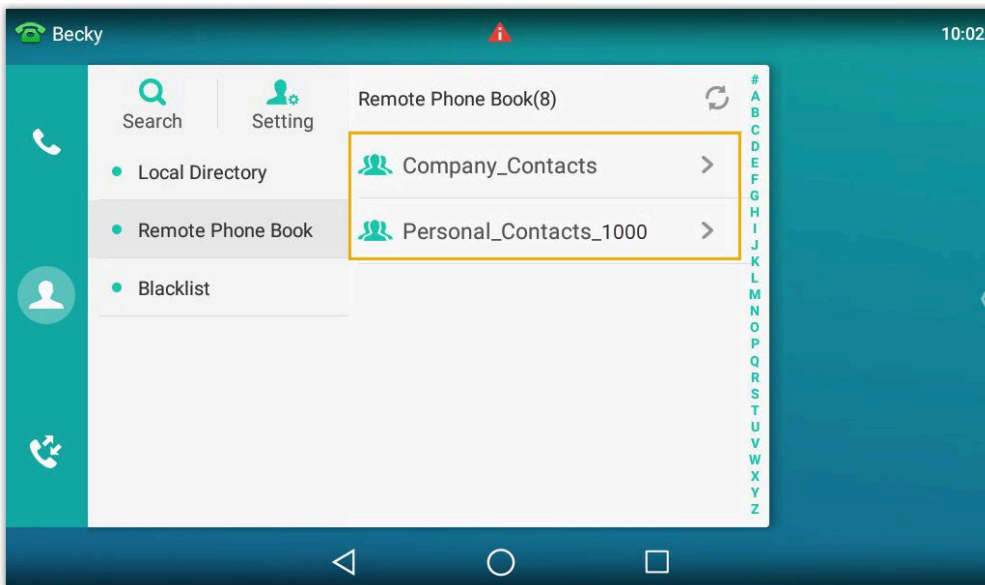

2. Tap **Search**.
3. In the search box, enter contact name or number. The system will query contact from Contacts.

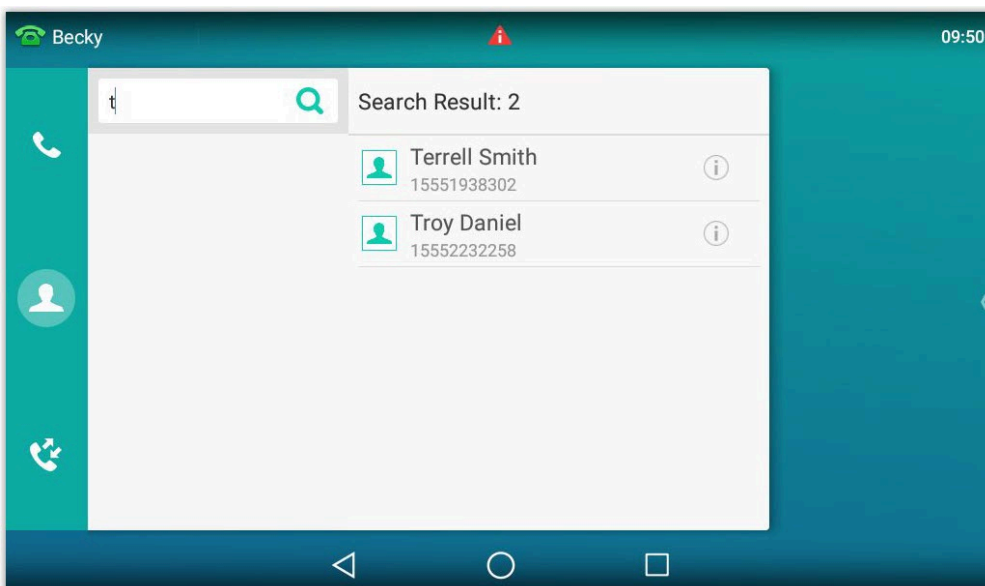

4. Select a contact, tap the contact number to quickly dial out.

Extension Group

Extension Group Overview

Yeastar P-Series PBX System supports to add specific extensions to a group, assign user types to these extensions, and grant permissions to extension users with different user types.

What is Extension Group

Extension group is a group that contains a number of extensions with a common function or purpose. Extension group is displayed on Linkus clients, which allows users to easily find a contact within a group, and makes it possible for authorized users to view or manage company contacts, or control calls of members within a specific group on Linkus Web Client.

User types in an extension group

A user type is a permission set, which allows you to control users' access to specific areas and features on Linkus Web Client. Yeastar P-Series PBX System provides 3 user types. You can assign user types to group members and grant permissions to each user type.

Default user types

- **Manager:** Assign the user type to a leader, so that he or she can manage members' calls or access organization's company contacts.
- **User:** Assign the user type to ordinary members. Any time you add members to a group, they are assigned the user type by default.

The following table displays default permissions for **Manager** and **User**, you can change the permissions according to your needs. For more information, see [View or change permissions for managers and users](#).

Module	Permission	Manager	User
Operator Panel	Switch group members' presence	#	#
	Call distribution management (Redirect, Transfer, Drag and Drop operation)	#	#
	Pick up or hang up other extensions' calls	#	#
	Call monitoring operations (Listen, Whisper, Barge-in)	#	#
	Call parking operations (Park, Retrieve)	#	#

Module	Permission	Manager	User
	Route calls directly from IVR regardless of the IVR menu	#	#
	Switch Business Hours and Holidays status	#	×
	Switch extension's recording status	#	×
Company Contacts	View Company Contacts	×	×
	Manage Company Contacts (Add, Edit, Delete Company Contact)	×	×

Custom user type

Custom: If you want to grant permissions to a specific member, you can assign the user type to a desired member, and customize permissions.

For more information, see [View or change permissions for a member with custom user type](#).

Default extension group

Yeastar P-Series PBX System has a built-in group **Default_All_Extensions** that contains all the extensions on the PBX. Any time you create an extension, the extension will be automatically added to the extension group. You can delete the group, or create one or more groups according to your needs.

For more information, see [Create an Extension Group](#).

Create an Extension Group

This topic describes how to create an extension group.

Procedure

1. Log in to the PBX web interface, go to **Extension and Trunk > Extension Group**, click **Add**.
2. Configure basic settings for the extension group.
 - a. In the **Name** field, enter a group name to help you identify it.
 - b. In the **Select Members** drop-down list, set which extensions will be added to the group.
 - **All Extensions:** If you choose the option, all the extensions will be moved to the **Selected** box.

 **Note:** ONLY one group that contains all the extensions is allowed.

- **Specific extensions:** If you choose the option, select the desired extensions from **Available** box to **Selected** box.

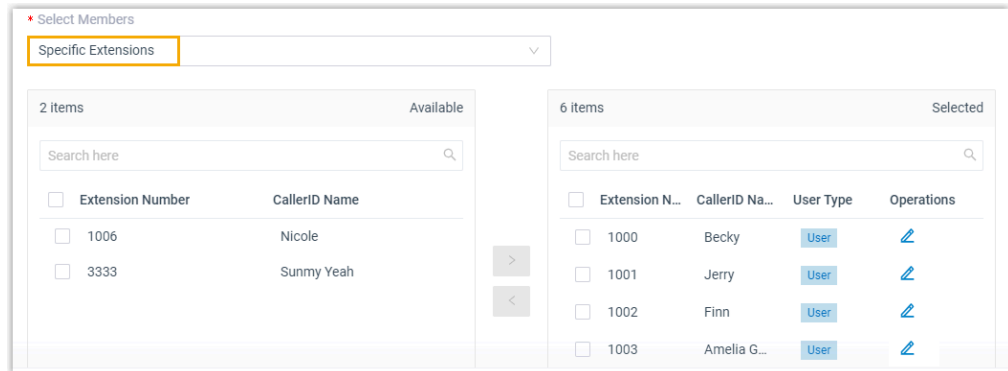

c. Assign user types for group members.

 **Note:** Users of different user types have different permissions. For more information, see [User types in an extension group](#).

- In the **Selected** box, click  beside the desired member.
- In the pop-up window, configure the **User Type** and permissions.
 - If you select **Manager** or **User**, the member has all the permissions that are granted to the user type.

 **Note:** The permissions of **Manager** and **User** are pre-defined. To change the permissions, see [View or change permissions for managers and users](#).

- If you select **Custom**, select the checkboxes of the desired permissions.

iii. Click **Save**.

- To define which users within your organization can view the group on Linkus clients, configure the group's visibility.
 - Click **Group Permissions** tab.
 - In the **Group Information Visibility** drop-down list, select a type.
 - **Visible to all Extensions:** All extension users can view the group.
 - **Visible to Extensions in this Group:** Only group members can view the group.
 - **Visible to Specific Extensions:** Only specific extension users can view the group.

If you choose the option, select the desired extensions from the drop-down list of **Specific extensions**, or enter the desired value.

4. Click **Save**.

Result

The extension group is displayed on **Extension Group** list; the authorized users can view the group on Linkus clients.

Manage Extension Groups

This topic describes how to edit or delete extension groups.

Edit an extension group

1. Log in to the PBX web interface, go to **Extension and Trunk > Extension Group**, click  beside the desired group.
2. Change group settings according to your needs.
3. Click **Save** and **Apply**.

Delete extension groups

1. Log in to the PBX web interface, go to **Extension and Trunk > Extension Group**.
2. To delete an extension group, do as follows:
 - a. Click  beside the desired group.
 - b. In the pop-up dialog box, click **OK**.
 - c. Click **Apply**.
3. To delete extension groups in bulk, do as follows:
 - a. Select the checkboxes of the desired groups, click **Delete**.
 - b. In the pop-up dialog box, click **OK**.
 - c. Click **Apply**.

The groups are removed from **Extension Group** list and are not displayed on Linkus clients.

Assign a User Type to a Group Member

Members of different user types have different permissions. You can control members' access to specific features by assigning different user types in an extension group. This topic describes how to assign a user type to a group member.

Assign a default user type to a group member

Yeastar P-Series PBX System provides two default user types: **Manager** and **User**, each of them has preset permissions. By assigning the two user types to members, you can bulk grant permissions to multiple members who share common responsibilities.

Prerequisites

Familiarize yourself with permissions of **Manager** and **User** in the desired group and change permissions according to your needs.

For more information, see [View or change permissions for managers and users](#).

Procedure

1. Log in to the PBX web interface, go to **Extension and Trunk > Extension Group**, edit the desired extension group.
2. Assign **Manager** or **User** to a group member.
 - a. In the **Members** section, click  beside the desired member.
 - b. In the **User Type** drop-down list, select **Manager** or **User** according to your needs.
 - c. Click **Save**.

Result

The member's user type and permissions in the group are updated.

Assign a custom user type to a group member

If you want a member to have different permissions from members with default user types, you can assign a custom user type to a desired member, and customize permissions.

Procedure

1. Log in to the PBX web interface, go to **Extension and Trunk > Extension Group**, edit the desired extension group.
2. Assign **Custom** to a group member, and grant permissions to the member according to your needs.
 - a. In the **Members** section, click  beside the desired member.
 - b. In the **User Type** drop-down list, select **Custom**.
 - c. Select the checkboxes of the desired permissions.
 - d. Click **Save**.
3. Click **Save** and **Apply**.

Result

The member's user type and permissions in the group are updated.

View or Change Permissions for Group Members

This topic describes how to view or change permissions for group members.

View or change permissions for managers and users

If members are assigned **Manager** or **User** in a group, all the members with the same user type have the same permissions. You can view the permissions of managers and users within a specific group, and change permissions according to your needs.

Procedure

1. Log in to the PBX web interface, go to **Extension and Trunk > Extension Group**, edit the desired extension group.
2. Click **Group Permissions** tab.
3. To view permissions, scroll down to **Permission Configuration** section.

You can view the permissions that are granted to **Manager** and **User** in the group.

4. To change permissions, do as follows:
 - a. In the **Permission Configuration** section, select or unselect the checkboxes of corresponding permissions for **Manager** and **User**.
 - b. Click **Save** and **Apply**.

Result

The permissions of all the managers and users in the group are updated in a batch.

What to do next

If you want to change members' user types to **Manager** or **User** in the group, see [Assign a default user type to a group member](#).

View or change permissions for a member with custom user type

For members with **Custom** user type assigned, permissions may vary from one member to another. You can view or change permissions for a specific member according to your needs.

Procedure

1. Log in to the PBX web interface, go to **Extension and Trunk > Extension Group**, edit the desired extension group.
2. In the **Members** section, click  beside the desired member whose user type is **Custom**.

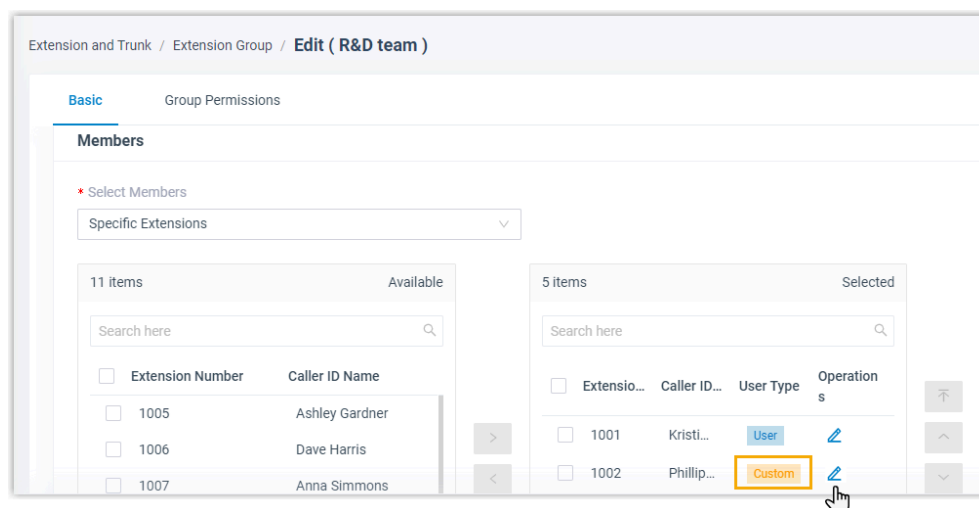

- a. In the pop-up window, select or unselect the checkboxes of the desired permissions for the user.
 - b. Click **Save**.
3. Click **Save** and **Apply**.

Result

The member's permissions are updated.

View or Change a Member's User Type in Multiple Groups

If an extension user plays different roles in different extension groups, you can quickly view or change multiple user types of the extension user without having to go to each group to view or assign the user types. This topic describes how to view or change a member's user type in multiple groups.

View a member's user type in multiple groups

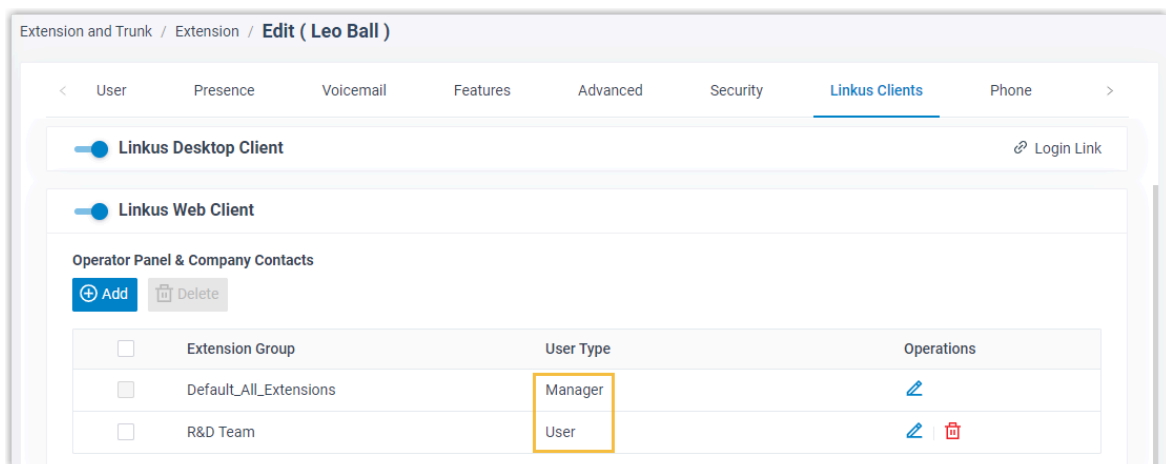

1. Log in to the PBX web interface, go to **Extension and Trunk > Extension**, click  beside desired extension.
2. Click **Linkus Clients** tab.
3. In the **Operator Panel & Company Contacts** section, you can see all the groups to which the extension user belongs. Check the user's user type in each group in **User Type** column.



Change a member's user type in multiple groups

The permissions of **Manager** and **User** vary from one group to another. Make sure you change permissions for the right group.

Procedure

1. Log in to the PBX web interface, go to **Extension and Trunk > Extension**, click  beside desired extension.
2. Click **Linkus Clients** tab.
3. In the **Operator Panel & Company Contacts** section, change the extension user's user type in a group.
 - a. Click  beside the desired extension group.
 - b. In the **User Type** drop-down list, select a user type.
 - If you select **Manager** or **User**, the user has all the permissions that are granted to the user type.
 - If you select **Custom**, select the checkboxes of the desired permissions.

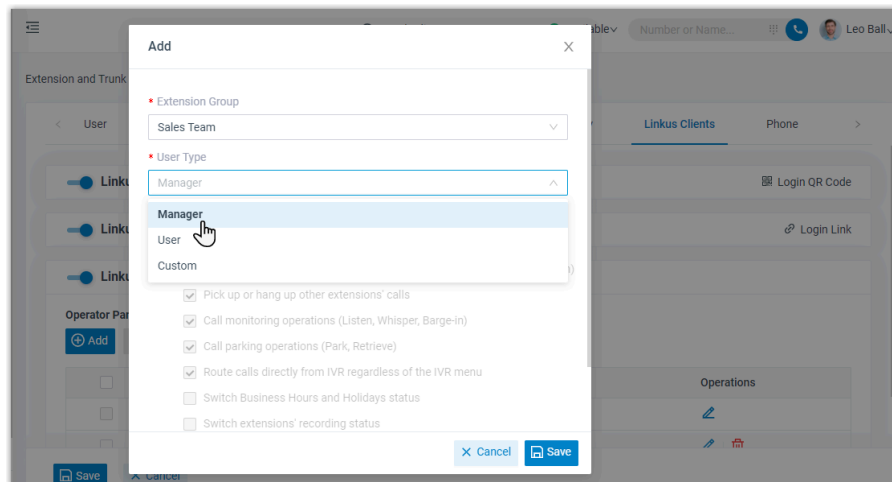

- c. Click **Save**.
4. Repeat **Step4** to assign user types for the extension in more groups.
5. Click **Save**.

Result

The user's user types and permissions in different groups are updated accordingly.

Related information

[Assign a User Type to a Group Member](#)

Auto Provisioning

Auto Provisioning Overview

This topic describes what is Auto Provisioning, provisioning supported devices, provisioning method, and which settings can be configured via Auto Provisioning.

What is Auto Provisioning

Auto Provisioning is a time-saving feature that helps you to manage and deploy devices centrally on Yeastar P-Series PBX System. The process of configuring devices, and managing firmware update is simplified to one-click provisioning, which makes deployment and management of devices fast and convenient.

Auto Provisioning supported devices

Yeastar P-Series PBX System supports various models for Auto Provisioning.

Find the [Auto Provisioning - Supported Devices](#) before you start deploying devices.

Provisioning method

Yeastar P-Series PBX System supports auto provisioning devices via Plug and Play (PnP) method.

PnP provides a proprietary method to auto provision devices from PBX server that are located in the local network.

Steps to provision devices via PnP method

1. Power on the PBX before you power on the devices (phones or gateways).
2. RESET the devices if they have been used previously.
3. Connect the devices to the same local network as PBX, and power on the devices.

 **Note:** The devices must be in the same network segment as the PBX (for example, the devices and PBX are all in the network segment 192.168.6.X), or the Auto Provisioning could not take effect.

4. Prepare a provisioning template.
5. Apply the provisioning template and assign extensions to these devices.

Which settings can be configured via Auto Provisioning

- **General settings (preferences & codecs)**

General settings provide the most common needs for extension users, such as phone language, date and time, etc. These settings can be auto provisioned by a template, so that the settings can be applied to multiple devices globally.

For more information, see [Auto Provision IP Phones](#).

- **Extension registration**

An extension will be registered on the device after auto provisioning. If you change extension registration settings (such as registration password, registration name, SIP UDP/TCP port), you need to reprovision your devices.

 **Note: Limit of extension registration**

For IP phone: Only one extension can be assigned to a phone via Auto Provisioning.

For DECT phone: Each handset registers with an extension via Auto Provisioning.

For more information, see [Auto Provision IP Phones](#), [Reassign an Extension to a Provisioned Phone](#).

- **Function Keys**

Various function keys are available for you to customize for each extension user, such as BLF, speed dial, etc. The function keys are associated to extensions, and can be applied when auto provisioning phones.

For more information about the function keys, see [Auto Provision Function Keys for Phones](#).

- **Device Firmware**

Yeastar P-Series PBX System allows you to update the device firmware in bulk by auto provisioning. For more information about firmware update, see [Update Phone Firmware via Auto Provisioning](#).

- **Additional settings**

In addition to the above settings, if you need to configure additional settings for the devices, you can also customize a template with additional parameters, and provision devices globally to apply the additional settings.

For more information, see [Create a Custom Auto Provisioning Template](#).

Manage Phones

Auto Provision IP Phones

This topic describes how to auto provision phones that are located in the same local network as Yeastar P-Series PBX System.

Prerequisites

- RESET the phones if they are previously used.
- Make sure that the phones are in the same network segment as the PBX.
- Prepare an auto provisioning template.

Procedure

1. Log in to the PBX web interface, go to **Auto Provisioning > Phones**.

The phone list displays all the discovered devices with their related information including model, MAC address, IP address, etc.

 **Note:** Restart the phones if they are not discovered and displayed on the phone provisioning list.

2. Select the desired phones to provision.

- To provision an individual phone, click  beside the desired phone.
- To provision multiple phones, select the checkboxes of the desired phones, and click **Edit**.

 **Note:** The selected phones must be of the same model.



3. In the **Options** section, select a desired template from the **Template** drop-down list.
4. In the **Assign Extension** section, assign an extension for each phone or handset.
5. Click **Save**.

Result

The configurations will be automatically applied to the phones.

What to do next

Go to **Auto Provisioning > Phones**, check extension registration status of provisioned phones.

- : The assigned extension is registered on the phone.
- : The assigned extension is unregistered on the phone.

Status	Extension	Name	Vendor	Model	IP Address	Phone Password	Template	Firmware Version
<input type="checkbox"/>	1000	Leo Ball	Yealink	SIP-T56A	192.168.6.33	-	YSDP_YealinkT56	58.83.0.15

Related information

[Modify a Provisioned Phone Settings](#)

[Auto Provision Function Keys for Phones](#)

Pre-provision IP Phones

This topic describes how to pre-provision IP phones.

Background information

Pre-provisioning is particularly useful for out-of-the-box scenarios in deployments of large number of phones.

Pre-provisioning allows you to provide general configurations for phones in advance. Instead of powering on and connecting each new phone to the same LAN as PBX, you can just add the new phones (Vendor, Model, and MAC address) to provisioning list on PBX, assign extensions to each phone and configure corresponding settings.

When users get their phones, power on and connect them to the same LAN as PBX System, the phones will be provisioned automatically.

Prerequisites

- Gather information of all phones, including Vendor, Model, and MAC address.
- Prepare an auto provisioning template.

Procedure

1. Log in to the PBX web interface, go to **Auto Provisioning > Phones**.
2. Click **Add** and select **Bulk Add**.
3. In the **IP Phone** section, configure phone information as follows:
 - **Vendor**: Select a phone vendor.
 - **Model**: Select a phone model.
 - **MAC Address**: Enter MAC address of each phone. Each on a separate line.
4. In the **Options** section, select a desired template from the **Template** field.
5. In the **Assign Extension** section, assign an extension to each phone.

 **Tip**: You can select an extension range from the **Start Extension** and **End Extension**, and click **Assign Extension** to assign an extension to each phone.
6. Click **Save**.

Result



The PBX generates a configuration file for each phone.

What to do next

1. Connect the phones to the same local network as the PBX, and power on the phones.

The phones automatically get configuration files from the PBX and apply the configurations.

 **Note:**

- If the phones are previously used, a factory reset is required.
 - The phones must be in the same network segment as the PBX (for example, the phones and PBX are all in the network segment 192.168.6.X), or the Auto Provisioning could not take effect.
2. Go to **Auto Provisioning > Phones**, check extension registration status of provisioned phones.
 - : The assigned extension is registered on the phone.
 - : The assigned extension is unregistered on the phone.

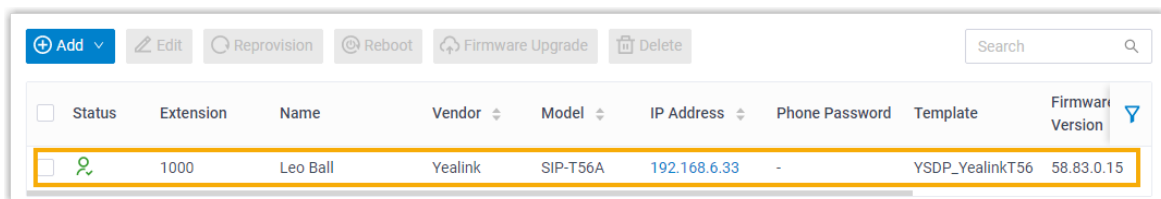

<input type="checkbox"/>	Status	Extension	Name	Vendor	Model	IP Address	Phone Password	Template	Firmware Version
<input type="checkbox"/>		1000	Leo Ball	Yealink	SIP-T56A	192.168.6.33	-	YSDP_YealinkT56	58.83.0.15

Modify a Provisioned Phone Settings

Centralized provisioning enables you to configure phones with the same settings, you can also customize settings for a specific phone after provisioning. This topic describes how to modify general settings for an IP phone and a DECT phone.

Modify settings of a provisioned IP phone

1. Log in to the PBX web interface, go to **Extension and Trunk > Extension**, edit the desired extension.
2. Modify the phone that is associated with the extension.
 - a. Click the **Phone** tab.
 - b. Modify phone settings in the **Preference** and **Codecs** sections.
 - c. Click **Save**.

 **Note:** If you want to change other settings, click the phone IP address displayed on the provisioning list to access the phone web interface, and change the configurations as your need.

3. Reprovision the phone to take effect.
 - a. Go to **Auto Provisioning > Phones**.
 - b. Click  beside the phone assigned to the extension user.

The phone automatically applies the changes.

Modify settings of a provisioned DECT phone

1. Log in to the PBX web interface, go to **Auto Provisioning > Phones**, edit a desired DECT phone.
2. Modify phone settings in the **Preference** and **Codecs** sections, and click **Save**.
3. On the phone provisioning list, click  beside the desired DECT phone to reprovise the phone.

The phone automatically applies the changes.

Auto Provision Function Keys for Phones

Each extension user can set his or her own function keys. When an extension and a phone are bound through auto provisioning, the function keys associated to the extension will be applied to the phone. This topic describes how to provision function keys for extension user.

Supported key types

The following table lists the function keys that you can assign for an extension user:

Key type	Function
Line	Monitor the registered extension.
BLF	<ul style="list-style-type: none"> • Monitor the status of a specific extension or a specific number. • Place a call to the monitored extension or number. • Pick up another user's incoming calls.
Speed Dial	Speed dial a number.
Check Voicemail	<ul style="list-style-type: none"> • Monitor the status of voicemail. • Check voicemail messages.
Park&Retrieve	<ul style="list-style-type: none"> • Monitor the status of a specific parking number. • Park a call on a specific parking number. • Retrieve a parked call from a specific parking number.
Intercom	Place an intercom call.
DTMF	Send DTMF signal.
Agent Login/Logout	<ul style="list-style-type: none"> • Log in to a specific queue. • Log out of a specific queue.
Agent Pause/unpause	<ul style="list-style-type: none"> • Pause receiving a call from a specific queue. • Unpause receiving a call from a specific queue.

Procedure

1. Assign function keys for extension users.
 - a. Log in to the PBX web interface, go to **Extension and Trunk > Extension**, edit the desired extension.

- If you want to assign function keys for a specific extension user, click  beside the desired extension.
 - If you want to assign function keys for multiple extensions, select the checkboxes of the desired extensions, and click **Edit**.
- b. Click the **Function Keys** tab.
 - c. Configure function keys.

 **Note:** The number of programmable keys varies by phone models. If the number of function keys you assign to an extension exceeds the number of programmable keys, the redundant function keys cannot take effect.

- **Type:** Select a key type.
 - **Value:** Configure a desired value based on the key type, such as parking number, queue, or extension.
 - **Label:** Optional. Enter a value, which will be displayed on the phone screen.
- d. Click **Save**.
2. If the extensions haven't be associated with phones, see [Auto Provision IP Phones](#) to bind phones with the extensions.
 3. If the extensions have been associated with phones, reprovision the phones to take effect.
 - a. Go to **Auto Provisioning > Phones**.
 - b. To reprovision a phone, click  beside the phone assigned to this extension user.
 - c. To reprovision multiple phones, select the checkboxes of the desired phones, click **Reprovision**.

Result

The phone automatically applies the changes. Check the function key status on the phone to see if the changes are applied.

Reassign an Extension to a Provisioned Phone

If you want to assign a provisioned phone to another user, you can reassign an extension to the provisioned phone. This topic describes how to reassign an extension to a provisioned phone.

Procedure

1. Log in to the PBX web interface, go to **Auto Provisioning > Phones**, edit the desired phone.
2. In the **Assign Extension** section, select a desired extension.

 **Note:** If your desired extension is not listed in the drop-down list, check if the extension has been associated with another phone. To release the previous phone, see [Release an Extension from a Provisioned Phone](#).

3. Click **Save**.

Result

The extension is automatically registered on the phone, and configurations in the selected template are applied to the phone.

 **Note:** If the selected extension has ever been configured via Auto Provisioning with the same template, the configurations in the previous phone will be inherited in the new phone.

Release an Extension from a Provisioned Phone

When an employee resigns or doesn't need the phone that is currently bound with the employee's extension, you can release the employee's extension from the phone. This topic describes how to release an extension from a provisioned phone.

Procedure

1. Release the extension from previous phone.
 - a. Log in to the PBX web interface, go to **Extension and Trunk > Extension**, edit a desired extension.
 - b. Click the **Phone** tab.
 - c. Click **Release From Phone** and **Yes**.
 - d. Click **Save**.

The extension is released from the phone.

2. Reprovision the phone to de-register the extension.

Go to **Auto Provisioning > Phones**, click  beside the phone from which you want to release extension.

Update Phone Firmware via Auto Provisioning

This topic describes how to update phone firmware via auto provisioning.

Prerequisites

Upload the desired phone firmware to PBX. For more information, see [Add a device firmware](#).

Update firmware to all applicable phones

1. Log in to the PBX web interface, go to **Auto Provisioning > Resource Repository > Device Firmware**.
2. Click  beside the desired firmware.
3. Click **Yes** to upgrade the phones.

Update firmware to specific phones

1. Log in to the PBX web interface, go to **Auto Provisioning > Phones**.
2. Select the checkboxes of the desired phones.
3. Click **Firmware Upgrade**.
4. Select the firmware that you want to upgrade, click **Upgrade Now**.

Result

The phones automatically reboot and update their firmwares to the new version.

Apply a New Template to a Provisioned Phone

If an extension user needs to customize his or her phone, you can create a custom template and apply the new template to his or her phone. This topic describes how to apply a new template to a provisioned phone.

Prerequisites

- [Create a custom auto provisioning template](#).

Procedure

1. Log in to the PBX web interface, go to **Auto Provisioning > Phones**, edit the desired phones.
2. In the **Options** section, select a desired template from the **Template** drop-down list.
3. Click **Save**.

Result

The configurations in the new template will be applied automatically to the phone.

Related information

[Update Auto Provisioning template\(s\) to all applicable devices](#)

Reboot Provisioned Phones

For some settings that need a phone reboot to take effect, you can reboot the phone remotely on PBX web interface. This topic describes how to reboot provisioned phones.

Procedure

1. Log in to the PBX web interface, go to **Auto Provisioning > Phones**.
2. Reboot phones according to your needs:
 - To reboot a phone, hover your mouse over  beside the desired phone, and click **Reboot**.
 - To reboot phones in bulk, select the checkboxes of desired phones, and click **Reboot**.

The system prompts you whether to reboot the phones.

3. Click **OK**.

Remove Phones from Provisioning List

The provisioning list always displays all the phones that are discovered. For the out-of-use phones, you can remove them from the phone provisioning list manually. This topic describes how to remove out-of-use phones from provisioning list.

Procedure

1. Log in to the PBX web interface, go to **Auto Provisioning > Phones**.
2. Remove phones according to your needs:
 - To remove a phone, hover your mouse over  beside the desired phone, and click **Delete**.
 - To remove phones in bulk, select the checkboxes of the desired phones, and click **Delete**.
3. Click **OK**.

Result

For the provisioned phones, the system erases all configuration files for the phone and releases the assigned extension.

Manage Gateways

Auto Provision Yeastar TA FXS Gateways

This topic describes how to auto provision Yeastar TA FXS gateways that are located in the same local network as Yeastar P-Series PBX System.

Prerequisites

- RESET the gateways if they are previously used.
- Make sure that the gateways are in the same network segment as the PBX, or Auto Provisioning configurations will not take effect.

 **Note:** A factory Yeastar TA FXS gateway is in DHCP network mode. You can connect an analog phone to any FXS port, dial *** and follow the voice prompt to check the IP address.

- Prepare an auto provisioning template.

Procedure

1. Log in to the PBX web interface, go to **Auto Provisioning > Gateways**.

The gateway list displays all the discovered devices with their related information including model, MAC address, IP address, etc.

 **Note:** Restart the gateways if they are not discovered and displayed on the gateway provisioning list.

2. Configure the gateway.
 - a. Click  beside the desired gateway.
 - b. In the **Options** section, select a desired template from the **Template** drop-down list.
 - c. Assign an extension for each port on gateway.
 - i. In the **Port Range** field, select the port range to assign extensions.
 - ii. In the **Start Extension** and **End Extension** field, select the extension range to assign to the specified ports.
 - iii. Click **Assign Extension**.

The ports with assigned extensions are displayed below. You can reassign an extension for a specific port.

d. In the **Preference** section, configure the settings as your need.

- **Key as Send:** Assign the pound key (“#”) or asterisk key (“*”) as the send key.
- **SIP VoIPServer IDX:** Select a VoIP server template ID to be provisioned.

Note: SIP VoIPServer IDX is not applicable for TA100 and TA200.

- **Admin Password:** Set the password for logging in to the gateway web interface.
- **LAN Settings:** Select the checkbox, and configure a static IP address for gateway to ensure that the gateway can always be accessed by the PBX system.

IP Address: Enter the IP address that is assigned to the gateway.

Subnet Mask: Enter the subnet mask.

Gateway: Enter the gateway address.

Preferred DNS Server: Enter the IP address of preferred DNS server.

Alternative DNS Server: Optional. Enter the IP address of alternative DNS server.

IP Address 2: Optional. Enter a second IP address for the gateway.

Note: According to your network environment, you may need to set another IP address to allow users in different IP segment to access the gateway.

Subnet Mask 2: Optional. Enter another subnet mask for the second IP address.

The following figure shows you an example of **Static IP** configuration.

e. In the **Codecs** section, select your preferred codec list for the gateway.

f. Click **Save**.

The PBX prompts you whether to reboot the gateway.

g. Click **OK** to reboot the gateway to apply the configurations.



Result

The configurations will be automatically applied to the gateways after reboot:

- The specified extensions will be registered on the corresponding ports of gateway.
- The gateway's IP is changed to a static IP address (192.168.6.168).

What to do next

Go to **Extension and Trunk > Extension**, check extension registration status in the **Online Status** column.

- : The assigned extension is registered on the gateway.
- : The assigned extension is unregistered on the gateway.

Related information

[Modify a Provisioned Gateway Settings](#)

Pre-provision Yeastar TA FXS Gateways

This topic describes how to pre-provision gateways.

Background information

Pre-provisioning is particularly useful for out-of-the-box scenarios.

Pre-provisioning allows you to provide general configurations for a gateway in advance. Instead of powering on and connecting a new gateway to the same LAN as PBX, you can just add the new gateway (Vendor, Model, and MAC address) to provisioning list on PBX, assign extensions to each port and configure corresponding settings.

When you power on and connect the gateway to the same LAN as PBX System, the gateways will be provisioned automatically.

Prerequisites

- Gather information of gateway, including Model, and MAC address.
- Prepare an auto provisioning template.

Procedure

1. Log in to the PBX web interface, go to **Auto Provisioning > Gateways**, click **Add**.

2. In the **Gateways** section, configure gateway information as follows:
 - **Model:** Select a gateway model.
 - **MAC Address:** Enter MAC address of gateway.
 - **Remark:** Optional. Enter a short description about the gateway.
3. In the **Options** section, select a desired template from the **Template** field.
4. Assign an extension for each port on gateway.
 - a. In the **Port Range** field, select the port range to assign extensions.
 - b. In the **Start Extension** and **End Extension** field, select the extension range to assign to the specified ports.
 - c. Click **Assign Extension**.

The ports with assigned extensions are displayed below. You can reassign an extension for a specific port.

The screenshot shows the 'Assign Extension' configuration window. At the top, there are three dropdown menus: 'Port Range' (set to 1-2), 'Start Extension' (set to 1005-Ashley Gardner), and 'End Extension' (set to 1006-Dave Harris). To the right of these is a blue button labeled 'Assign Extension'. Below the form is a table with two rows. The first row is for 'Port 1' and the second for 'Port 2'. Each row has a checked checkbox on the left and a dropdown menu on the right showing the assigned extension: '1005-Ashley Gardner' for Port 1 and '1006-Dave Harris' for Port 2.

5. In the **Preference** section, configure the settings as your need.
 - **Key as Send:** Assign the pound key (“#”) or asterisk key (“*”) as the send key.
 - **SIP VoIPServer IDX:** Select a VoIP server template ID to be provisioned.

 **Note:** SIP VoIPServer IDX is not applicable for TA100 and TA200.

- **Admin Password:** Set the password for logging in to the gateway web interface.
- **LAN Settings:** Select the checkbox, and configure static IP address for gateway.
 - # **IP Address:** Enter the IP address that is assigned to the gateway.
 - # **Subnet Mask:** Enter the subnet mask.
 - # **Gateway:** Enter the gateway address.
 - # **Preferred DNS Server:** Enter the IP address of preferred DNS server.
 - # **Alternative DNS Server:** Optional. Enter the IP address of alternative DNS server.
 - # **IP Address 2:** Optional. Enter a second IP address for the gateway.

 **Note:** According to your network environment, you may need to set another IP address to allow users in different IP segment to access the gateway.

- # **Subnet Mask 2:** Optional. Enter another subnet mask for the second IP address.

The following figure shows you an example of **Static IP** configuration.

The screenshot shows a configuration form for LAN settings. At the top, there is an 'Admin Password' field with a strength indicator. Below it, the 'LAN Settings' checkbox is checked. There are three radio buttons for network mode: 'DHCP', 'Static IP Address' (which is selected), and 'PPPoE'. The form contains several input fields: 'Hostname' (TA400), 'Subnet Mask' (255.255.255.0), 'Preferred DNS Server' (8.8.8.8), 'IP Address' (192.168.6.168), 'Gateway' (192.168.6.1), 'Alternative DNS Server' (empty), 'IP Address 2' (empty), and 'Subnet Mask 2' (empty).

6. In the **Codecs** section, select your preferred codec list for gateway.
7. Click **Save**.

Result



The PBX generates a configuration file for gateway.

What to do next

1. Connect your gateway to the same local network as the PBX, and power on your gateway.

The gateway automatically get the configuration file from the PBX and apply the configurations.

Note:

- If the gateways are previously used, a factory reset is required.
 - The gateways must be in the same network segment as the PBX (for example, the gateways and PBX are all in the network segment 192.168.6.X), or the Auto Provisioning can not take effect.
2. Go to **Extension and Trunk > Extension**, check extension registration status on **Online Status** field.
 - : The assigned extension is registered on the gateway.
 - : The assigned extension is unregistered on the gateway.

Modify a Provisioned Gateway Settings

Centralized provisioning enables you to configure gateways with the same settings, you can also customize settings for a specific gateway after provisioning. This topic describes how to modify general settings for a gateway.

Procedures

1. Log in to the PBX web interface, **Auto Provisioning > Gateways**, edit a desired gateway.
2. Modify phone settings in the **Preference** and **Codecs** sections, and click **Save**.

 **Note:** If you want to change other settings, click the gateway IP address displayed on the provisioning list to access the gateway web interface, and change the configurations as your need.

The PBX prompts you whether to reboot the gateway.

3. Click **OK** to reboot the gateway to apply the configurations.

The gateway will automatically apply the changes after reboot.

Reassign an Extension to a Provisioned Gateway

This topic describes how to reassign an extension to a provisioned gateway.

Procedure

1. Log in to the PBX web interface, go to **Auto Provisioning > Gateways**, edit the desired gateway.
2. In the **Assign Extension** section, select a desired extension for a desired port.

 **Note:** If your desired extension is not listed in the drop-down list, check if the extension has been associated with another device. To release the previous device, see [Release an Extension from a Provisioned Phone](#), or [Release an Extension from a Provisioned Gateway](#).

3. Click **Save**.

The PBX generates a configuration file for gateway, and prompts you whether to reboot the gateway.

4. Click **OK** to reboot the gateway to apply the configurations.

Result

The extension is automatically registered on the gateway port after reboot.

Release an Extension from a Provisioned Gateway

This topic describes how to release an extension from a provisioned gateway port.

Procedure

1. Release the extension from previous port.

- a. Log in to the PBX web interface, go to **Extension and Trunk > Extension**, edit a desired extension.
- b. Click the **Phone** tab.
- c. Click **Release From Phone** and **Yes**.
- d. Click **Save**.

The extension is released from the gateway.

2. Reboot the gateway to apply the configurations.

Result

The extension is automatically unregistered on the gateway port after reboot.

Apply a New Template to a Provisioned Gateway

If you want to customize a gateway, you can create a custom template and apply the new template to the gateway. This topic describes how to apply a new template to a provisioned gateway.

Prerequisites

- [Create a custom auto provisioning template](#).

Procedure

1. Log in to the PBX web interface, go to **Auto Provisioning > Gateways**, edit a desired gateway.
2. In the **Options** section, select a desired template from the **Template** drop-down list.
3. Click **Save**.

The PBX prompts you whether to reboot the gateway.

4. Click **OK** to reboot the gateway to apply the configurations.

Result

The configurations in the new template will be applied automatically to the gateway.

Related information

[Update Auto Provisioning template\(s\) to all applicable devices](#)

Reboot Provisioned Gateways

Every time you change settings for a gateway, you need to reboot the gateway to make configurations take effect. This topic describes how to reboot provisioned gateways remotely on PBX web interface.

Procedure

1. Log in to the PBX web interface, go to **Auto Provisioning > Gateways**.
2. Reboot gateways according to your needs:
 - To reboot a gateway, click  beside the desired gateway.
 - To reboot gateways in bulk, select the checkboxes of desired gateways, click **Reboot**.

The system prompts you whether to reboot the gateways.

3. Click **OK**.

Remove Gateways from Provisioning List

The provisioning list always displays all the gateways that are discovered. For the out-of-use gateways, you can remove them from the gateways provisioning list manually. This topic describes how to remove out-of-use gateways from provisioning list.

Procedure

1. Remove gateway from provisioning list.
 - a. Log in to the PBX web interface, go to **Auto Provisioning > Gateways**.
 - b. Remove phones according to your needs:
 - To remove a phone, click  beside the desired gateways.
 - To remove gateways in bulk, select the checkboxes of the desired gateways, and click **Delete**.
 - c. Click **OK**.
2. If the gateways you remove have been provisioned, reboot the provisioned gateways.

Result

For the provisioned gateways, the system erases all configuration files for the gateways and releases the assigned extension.

Manage Auto Provisioning Template

View a Default Auto Provisioning Template

The default template of different models contains different parameters, you can view what configurations are included in the default template. This topic describes how to search and view a default template.

Background information

Yeastar P-Series PBX System provides various default templates for each supported device. Devices of different models may share the same template. For example, the template YSDP_YealinkT5xS of Yealink applies to Yealink T52S and T54S.

The value of default template

The default template contains general settings that are predefined based on device model. There are two types of parameter value in the template: variables and absolute value.

- **Variables:** Variables are attributes to which various values can be assigned. A variable starts with `{{ .`, and ends with `}}`. For example, `{{ .PhoneWebLanguage }}` means a variable of Phone Web Language setting. The phone web language varies on each phone according to specific phone configuration.
- **Absolute value:** Absolute is a fixed value that applies to all devices that use this template. For example, `features.dtmf.hide_delay = 1` means setting the parameter value to 1 (Enabled).

Procedure

1. Log in to the PBX web interface, go to **Auto Provisioning > Resource Repository**.
2. Select a device vendor or enter a keyword.

You can search the template by vendor, provisioning template name, or device model. The search results are displayed automatically on the web page.

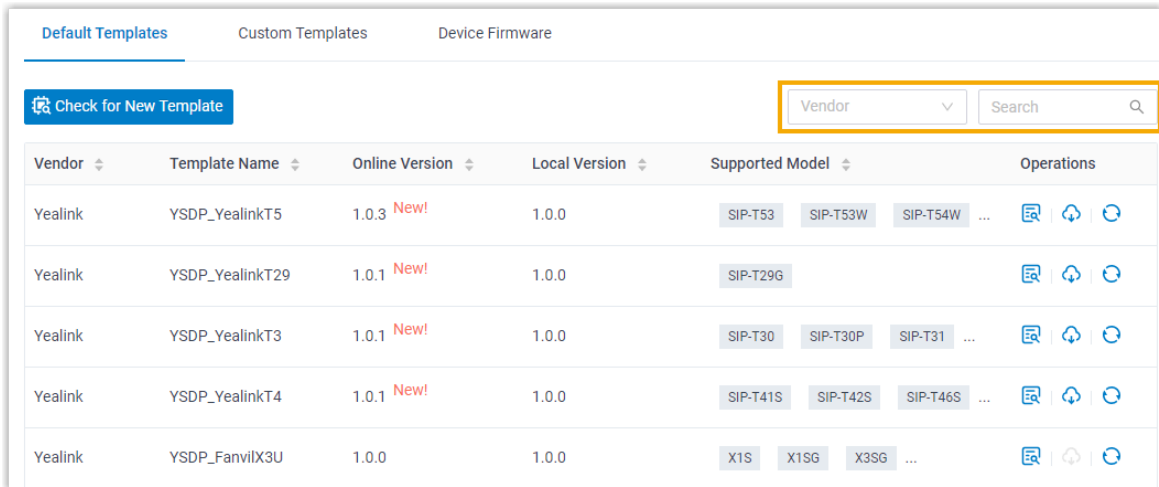

Vendor	Template Name	Online Version	Local Version	Supported Model	Operations
Yealink	YSDP_YealinkT5	1.0.3 New!	1.0.0	SIP-T53 SIP-T53W SIP-T54W ...	[Icon] [Icon] [Icon]
Yealink	YSDP_YealinkT29	1.0.1 New!	1.0.0	SIP-T29G	[Icon] [Icon] [Icon]
Yealink	YSDP_YealinkT3	1.0.1 New!	1.0.0	SIP-T30 SIP-T30P SIP-T31 ...	[Icon] [Icon] [Icon]
Yealink	YSDP_YealinkT4	1.0.1 New!	1.0.0	SIP-T41S SIP-T42S SIP-T46S ...	[Icon] [Icon] [Icon]
Yealink	YSDP_FanvilX3U	1.0.0	1.0.0	X1S X1SG X3SG ...	[Icon] [Icon] [Icon]

3. Click  beside the desired template to view the default configurations. The following figure shows a default template of Yealink T56A. The default template consists of two parts:
 - **Configuration parameters in Default Template:** The predefined configuration parameters in this template are displayed in the first text box.

- **Function keys of device model:** The predefined function keys supported by the device model are displayed in the second text box.

You can click the device model tab to view the supported keys.

Check Default Template - YSDP_YealinkT4
✕

Configuration Parameters in Default Template

```

local_time.summer_time = {{.DaylightSavingTime}}
local_time.ntp_server1 = {{.PrimaryNtpServer}}
local_time.ntp_server2 = {{.SecondaryNtpServer}}
local_time.time_format = {{.TimeFormat}}
local_time.date_format = {{.DateFormat}}
transfer.dsskey_deal_type = {{.TransferModeViaDsskey}}
features.dtmf.hide = {{.SuppressDtmfDisplay}}
features.dtmf.hide_delay = 1
features.intercom.led.enable = 1
features.intercom.subscribe.enable = 1

```

The configuration parameters below are used to configure function keys, which will define the value of the variables in the default template: {{.FunctionkeySyntax}}.

SIP-T41S
SIP-T42S
SIP-T46S
SIP-T48S
SIP-T41U
SIP-T42U
SIP-T43U

SIP-T46U
SIP-T48U

```

#FUNCTIONKEY1
linekey.1.type = {{.FunctionkeyType_1}}
linekey.1.line = {{.FunctionkeyLine_1}}
linekey.1.value = {{.FunctionkeyCodeValue_1}}{{.FunctionkeyValue_1}}
linekey.1.label = {{.FunctionkeyLabel_1}}
linekey.1.extension = {{.FunctionkeyCodeExtension_1}}
#FUNCTIONKEY2
linekey.2.type = {{.FunctionkeyType_2}}
linekey.2.line = {{.FunctionkeyLine_2}}

```

Related information

- [Create a Custom Auto Provisioning Template](#)
- [Manage Custom Auto Provisioning Template](#)

Update a Default Auto Provisioning Template

Yeastar P-Series PBX System regularly provides new template versions to release new features and fix bugs. You can check if a new template is available, and decide whether to update the default template. This topic describes how to update a default template.









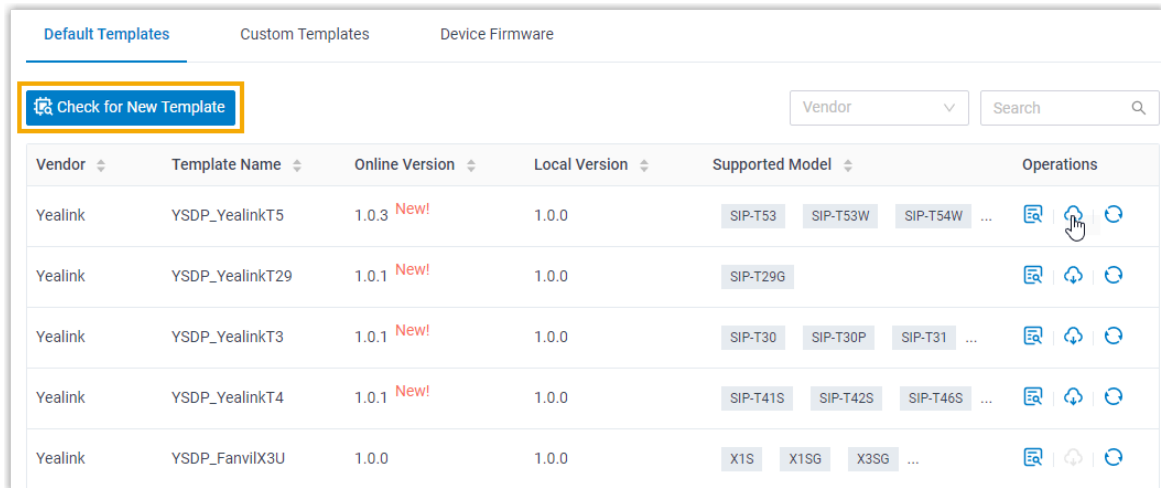





Prerequisites

Make sure that your PBX can connect to Internet, or new templates will not be detected

Procedure

1. Log in to the PBX web interface, go to **Auto Provisioning > Resource Repository**.
2. Click **Check for New Template** to obtain the new template.
3. If a new template is detected, click  to download the new template.



Vendor	Template Name	Online Version	Local Version	Supported Model	Operations
Yealink	YSDP_YealinkT5	1.0.3 New!	1.0.0	SIP-T53 SIP-T53W SIP-T54W ...	  
Yealink	YSDP_YealinkT29	1.0.1 New!	1.0.0	SIP-T29G	  
Yealink	YSDP_YealinkT3	1.0.1 New!	1.0.0	SIP-T30 SIP-T30P SIP-T31 ...	  
Yealink	YSDP_YealinkT4	1.0.1 New!	1.0.0	SIP-T41S SIP-T42S SIP-T46S ...	  
Yealink	YSDP_FanvilX3U	1.0.0	1.0.0	X1S X1SG X3SG ...	  

4. Click  beside the desired template to view the default configurations.

For more information, see [View a Default Auto Provisioning Template](#).

What to do next

To apply the new template to the devices that have been auto provisioned by the same template with previous version, click .

Create a Custom Auto Provisioning Template

If you want to customize the general settings defined in a default provisioning template, or you want to add custom parameters, you can create a custom Auto Provisioning template. This topic describes how to create a custom Auto Provisioning template.

Background information

Custom template allows you to customize device settings. You can easily modify and apply the custom template to a group of devices, or an individual device.

Yeastar P-Series PBX System provides two types of custom template:

- **Basic Custom Template:** Allow you to customize the parameters provided in the default template.

- **Advanced Custom Template:** Allow you to customize parameters provided in the default template, and add additional parameters for the desired phones.



Note: Contact your vendor to make sure that the added parameters are supported.

Create a Auto Provisioning basic template

If you want to customize the settings that are defined in a default provisioning template, you can create a basic Auto Provisioning template.

1. Log in to the PBX web interface, go to **Auto Provisioning > Resource Repository > Custom Templates**.
2. Click **Add**.
3. In the **Basic** section, set basic information.
 - **Template Name:** Enter a name to help you identify it.
 - **Source Default Template:** Select a default provisioning template to customize.
 - **Template Type:** Select **Basic**.

The general settings that the source default template provides will be displayed in the **Preference** and **Codec** sections.

 - **Remark:** Optional. Enter a short description about this template.
4. In the **Preference** section, modify the preference settings that are provided by the source default template.
5. In the **Codecs** section, select a desired codec according to your needs.
6. Click **Save**.

Create an advanced Auto Provisioning template

If the settings that you want to configure for your devices are not defined in the default provisioning template, you can create an advanced Auto Provisioning template.

1. Log in to the PBX web interface, go to **Auto Provisioning > Resource Repository > Custom Templates**.
2. Click **Add**.
3. In the **Basic** section, set the basic information.
 - **Template Name:** Enter a name to help you identify it.
 - **Source Default Template:** Select a default template to customize.
 - **Template Type:** Select **Advanced**.

The general settings that the source default template provides will be displayed in the **Preference** and **Codec** sections; And a text box containing all configuration parameters will be displayed in the **Customize Configuration Parameters In Text** section.

 - **Remark:** Optional. Enter a short description about this template.
4. In the **Preference** section, modify the preference settings that are provided by the source default template.
5. In the **Codecs** section, select a desired codec according to your needs.

6. Add additional parameters that are not provided by the source default template.

 **Note:** The general settings defined in source default template are assigned with variables. The variable that starts with `{{` and ends with `}}` is associated with the configuration that can be configured on **Preference**, **Codecs**, and **Function Keys** sections. Please don't change the variable if you want to modify the settings from PBX web interface.

a. In the **Customize Configuration Parameters In Text** section, add your configuration parameters in the first text box.

 **Note:** Contact your vendor to make sure that the parameters are supported for the device model.

b. In the second text box, select which function keys to be applied according to the phone model.

You can also add your function key parameters in the second text box.

The configuration parameters below are used to configure function keys, which will define the value of the variables in the custom template: `{{FunctionkeySyntax}}`.
If you need to provision function keys, please do not remove the variables from the custom template.

SIP-T41S SIP-T42S SIP-T46S SIP-T48S SIP-T41U SIP-T42U SIP-T43U SIP-T46U SIP-T48U

```
#FUNCTIONKEY1
linekey.1.type = {{FunctionkeyType_1}}
linekey.1.line = {{FunctionkeyLine_1}}
linekey.1.value = {{FunctionkeyCodeValue_1}}{{FunctionkeyValue_1}}
linekey.1.label = {{FunctionkeyLabel_1}}
linekey.1.extension = {{FunctionkeyCodeExtension_1}}

#FUNCTIONKEY2
linekey.2.type = {{FunctionkeyType_2}}
linekey.2.line = {{FunctionkeyLine_2}}
linekey.2.value = {{FunctionkeyCodeValue_2}}{{FunctionkeyValue_2}}
linekey.2.label = {{FunctionkeyLabel_2}}
linekey.2.extension = {{FunctionkeyCodeExtension_2}}
```

7. Click **Save**.

Related information

[Edit a custom Auto Provisioning template](#)

[Update Auto Provisioning template\(s\) to all applicable devices](#)

Manage Custom Auto Provisioning Template

This topic describes how to edit or delete custom Auto Provisioning templates.

Edit a custom Auto Provisioning template

1. Log in to the PBX web interface, go to **Auto Provisioning > Resource Repository > Custom Templates**.
2. Click  beside a desired custom template.
3. Modify the device settings.
4. Click **Save**.

The system prompts you whether to update the new configurations to devices that use this template.

- **Yes:** The system generates new configuration files and immediately triggers provisioning for all devices that use this template.
- **No:** The system saves the changes to this template, and generates new configuration files for all devices that use this template. You can trigger provisioning manually for specific devices later.

Delete custom Auto Provisioning templates

1. Log in to the PBX web interface, go to **Auto Provisioning > Resource Repository > Custom Templates**.
2. Delete custom templates according to your needs.
 - To delete a custom template, click  beside the desired template.
 - To delete custom templates in bulk, select the checkboxes of desired templates, click **Delete**.
3. In the pop-up dialog box, click **Yes**.

If the template is in use, you need to release it from the devices that use the template first.

Update Auto Provisioning template(s) to all applicable devices

1. Log in to the PBX web interface, go to **Auto Provisioning > Resource Repository > Custom Templates**.
2. Update the configurations to the devices:
 - To update the configuration of a specific template, click  beside the desired template.
 - To update the configuration of multiple templates, select the checkboxes of desired templates, click **Update to Device**.
3. Click **Yes** to trigger phone provisioning.

Manage Device Firmware

Manage Device Firmware Files

This topic describes how to manage device firmwares, including add, edit, and delete device firmware files.

Add a device firmware file

You can upload up to three device firmware files to PBX server.

1. Log in to the PBX web interface, go to **Auto Provisioning > Resource Repository > Device Firmware**, click **Add**.
2. In the **Device** section, select a firmware vendor and device model.
3. In the **Firmware** section, upload the firmware.
 - **Firmware Version**: Enter a name (firmware version) to help you identify it.
 - **Upload Firmware File**: Click **Browse** and select the corresponding firmware.
 - **Remark**: Optional. Enter a short description about the firmware.
4. Click **Save**.

The uploaded firmware is displayed on the **Device Firmware** list. When you update phone firmware, the uploaded firmware can be detected and displayed for you to choose.

Edit a device firmware file

1. Log in to the PBX web interface, go to **Auto Provisioning > Resource Repository > Device Firmware**.
2. Click  beside the desired firmware.
3. In the **Firmware** section, edit the firmware information or update the firmware file.
 - **Firmware Version**: Enter a name (firmware version) to help you identify it.
 - **Upload**: Click **Browse** and select the corresponding firmware.
 - **Remark**: Optional. Edit the note.
4. Click **Save**.

Delete device firmware files

1. Log in to the PBX web interface, go to **Auto Provisioning > Resource Repository > Device Firmware**.
2. Delete device firmware files.
 - To delete a device firmware, click  beside the desired firmware.
 - To delete device firmwares in bulk, select the checkboxes of the desired firmware, and click **Delete**.
3. Click **OK**.

Auto Provisioning - Supported Devices

This topic lists the devices that are currently supported for Auto Provisioning by Yeastar P-Series PBX System.

Yealink Phones

Table 18.

Model	Firmware
SIP-T19P_E2	53.84.0.125 or later
SIP-T21P_E2	52.84.0.125 or later
SIP-T21_E2	52.84.0.125 or later
SIP-T23P	44.84.0.125 or later
SIP-T23G	44.84.0.125 or later
SIP-T27G	69.85.0.5 or later
SIP-T29G	46.83.0.120 or later
SIP-T30	124.85.0.15 or later
SIP-T30P	124.85.0.15 or later
SIP-T31	124.85.0.15 or later
SIP-T31P	124.85.0.15 or later
SIP-T31G	124.85.0.15 or later
SIP-T33P	124.85.0.15 or later
SIP-T33G	124.85.0.15 or later
SIP-T40P	54.84.0.125 or later
SIP-T40G	76.84.0.125 or later
SIP-T41P	36.83.0.120 or later
SIP-T42G	29.83.0.120 or later
SIP-T46G	28.83.0.120 or later
SIP-T48G	35.83.0.120 or later
SIP-T41S	66.85.0.5 or later
SIP-T42S	66.85.0.5 or later
SIP-T46S	66.85.0.5 or later
SIP-T48S	66.85.0.5 or later
SIP-T41U	108.85.0.39 or later
SIP-T42U	108.85.0.39 or later
SIP-T43U	108.85.0.39 or later
SIP-T46U	108.85.0.39 or later
SIP-T48U	108.85.0.39 or later

Table 18. (continued)

Model	Firmware
SIP-T52S	70.84.0.70 or later
SIP-T54S	70.84.0.70 or later
SIP-T53	96.85.0.5 or later
SIP-T53W	96.85.0.5 or later
SIP-T54W	96.85.0.5 or later
SIP-T57W	96.85.0.5 or later
SIP-T56A	58.83.0.15 or later
SIP-T58	58.85.0.5 or later
VP59	91.85.0.5 or later
W80B	W80DM-103.83.0.30
W60B	77.83.0.85 or later
W90DM	130.85.0.15 or later
CP960	73.85.0.5 or later
CP920	78.85.0.5 or later

Fanvil phones

Model	Firmware
X1S/X1SP	2.2.12 or later
X1SG	2.2.12 or later
X3SG	2.2.12 or later
X3U	2.2.12 or later
X4U	2.2.11 or later
X5U	2.2.11 or later
X5S	2.2.1 or later
X6	2.2.1 or later
X6U	2.2.11 or later
X7	2.2.11 or later
X7C	2.2.11 or later
X7A	2.2.0.229 or later
X210	2.2.11 or later

Model	Firmware
X210i	2.2.11 or later

Yeastar gateways

Model	Firmware
TA100	44.19.86.30 or later
TA200	44.19.86.30 or later
TA400	41.19.0.32 or later
TA800	41.19.0.32 or later
TA1600	47.0.0.54 or later
TA2400	47.0.0.54 or later
TA3200	47.0.0.54 or later

Auto Provisioning - Variables in Templates

The provision templates make use of a set of variables which are replaced by the actual value when a device is provisioned. This topic shows you the variables used in the provisioning templates.

Variable	Description
Preference settings	
{{.PhoneWebLanguage}}	The language configured on phone web interface.
{{.PhoneLanguage}}	The language configured on phone interface.
{{.Tones}}	The default ringtone of the phone.
{{.CallWaiting}}	Enable or disabled call waiting feature.
{{.PhoneUser}}	The user name for logging in to the phone web interface.
{{.PhonePassword}}	The password for logging in to the phone web interface.
{{.TimeZone}}	The time zone.
{{.TimeZoneName}}	The time zone name.
{{.DaylightSavingTime}}	The daylight savings time.
{{.PrimaryNtpServer}}	The primary NTP server address.
{{.SecondaryNtpServer}}	The second NTP server address.
{{.TimeFormat}}	The time format.

Variable	Description
{{.DateFormat}}	The date format.
{{.DateSeparatorFormat}}	The date separator format.
{{.TransferModeViaDsskey}}	The transfer mode for function key.
{{.SuppressDtmfDisplay}}	Enable or disable the IP phone to suppress the display of DTMF digits.
{{.AutoProvisionServerUrl}}	The URL of provision server.
{{.ProvisioningFile}}	The name of configuration file.
{{.FirmwareUrl}}	The URL of firmware.
{{.FirmwareFile}}	The name of firmware.
{{.FirmwareVersion}}	The version of firmware.
Contact settings for Yealink phones	
 Note: Contact settings is not available for VP59, W80B, W60B, W90DM, CP960 and CP920 phones.	
{{.CompanyPbUrl}}	The URL of company contact file.
{{.CompanyPbName}}	The name of company contact.
{{.PersonalPbUrl}}	The URL of personal contact file.
{{.PersonalPbName}}	The name of personal contact.
Account settings for IP phones	
{{.EnbAccount}}	Enable or disable extension registration.
{{.AccountLabel}}	The extension label.
{{.AccountDisplayName}}	The display name of extension.
{{.AccountRegistrationName}}	The registration name of extension.
{{.AccountRegistrationExtNumber}}	The registration number of extension.
{{.AccountRegistrationPassword}}	The registration password of extension.
{{.AccountSipServerAddr}}	The URL of PBX server for extension registration.
{{.AccountSipServerPort}}	The port of PBX server for extension registration.
{{.AccountSipServerTransportType}}	The type of transport protocol for extension registration.
{{.AutoAnswer}}	Enable or disable auto answer feature.
{{.CheckVoicemail}}	The voicemail feature code.
Account settings for DECT phones (_x is the handset ID)	
{{.EnbAccount_x}}	Enable or disable extension registration.
{{.AccountLabel_x}}	The extension label.

Variable	Description
{{.AccountDisplayName_x}}	The display name of extension.
{{.AccountRegistrationName_x}}	The registration name of extension.
{{.AccountRegistrationExtNumber_x}}	The registration number of extension.
{{.AccountRegistrationPassword_x}}	The registration password of extension.
{{.AccountSipServerAddr_x}}	The URL of provisioning server for extension registration.
{{.AccountSipServerPort_x}}	The port of provisioning server for extension registration.
{{.AccountSipServerTransportType_x}}	The type of transport protocol for extension registration.
{{.CheckVoicemail_x}}	The voicemail feature code.
SIP server template for Yealink W80B (x is the template ID, X=1, 2 or 3)	
{{.TemplateNamex}}	The template name.
{{.TemplateServerAddrx}}	The URL of PBX server for extension registration.
{{.TemplateServerPortx}}	The port of PBX server for extension registration.
{{.AccountSipServerTemplate}}	The type of transport protocol for extension registration.
Audio codec (x is the codec priority, X=1, 2, 3 or 4)	
{{.AccountAudioCodec_X}}	The the priority of the audio codec.
{{.AudioCodecsPriorities}}	The the priority of the audio codec.
{{.AccountCodecPcmu}}	Enables or disables PCMU audio codec.
{{.AccountCodecPcmu_Priority}}	The the priority of the PCMU audio codec.
{{.AccountCodecPcma}}	Enables or disables PCMA audio codec.
{{.AccountCodecPcma_Priority}}	The the priority of the PCMA audio codec.
{{.AccountCodecllbc}}	Enables or disables iLBC audio codec.
{{.AccountCodecllbc_Priority}}	The the priority of the iLBC audio codec.
{{.AccountCodecllbc_15_2_Kbps}}	Enables or disables iLBC_15_2 audio codec.
{{.AccountCodecllbc_15_2_Kbps_Priority}}	The the priority of the iLBC_15_2 audio codec.
{{.AccountCodecllbc_13_33_Kbps}}	Enables or disables iLBC_13_33 audio codec.
{{.AccountCodecllbc_13_33_Kbps_Priority}}	The the priority of the iLBC_13_33 audio codec.
{{.AccountCodecG722}}	Enables or disables G722 audio codec.
{{.AccountCodecG722_Priority}}	The the priority of the G722 audio codec.
{{.AccountCodecG729}}	Enables or disables G729 audio codec.

Variable	Description
{{.AccountCodecG729_Priority}}	The the priority of the G729 audio codec.
{{.AccountCodecG726_32}}	Enables or disables G726_32 audio codec.
{{.AccountCodecG726_32_Priority}}	The the priority of the G726_32 audio codec.
{{.AccountCodecSpeex}}	Enables or disables Speex audio codec.
{{.AccountCodecSpeex_Priority}}	The the priority of the Speex audio codec.
{{.AccountAdpcmCodec}}	Enables or disables Adpcm audio codec.
{{.AccountCodecAdpcm_Priority}}	The the priority of the Adpcm audio codec.
::{{.AccountCodecMpeg4}}	Enables or disables Mpeg4 audio codec.
{{.AccountCodecMpeg4_Priority}}	The the priority of the Mpeg4 audio codec.
{{.AccountCodecGsm}}	Enables or disables GSM audio codec.
{{.AccountCodecGsm_Priority}}	The the priority of the GSM audio codec.
{{.AccountCodecOpus}}	Enables or disables Opus audio codec.
{{.AccountCodecOpus_Priority}}	The the priority of the Opus audio codec.
Video codec (<i>x</i> is the codec priority, X=1, 2, 3 or 4)	
{{.AccountVideoCodec_X}}	The the priority of the video codec.
{{.AccountCodecH264}}	Enables or disables H264 codec.
{{.AccountCodecH264_Priority}}	The the priority of the H264 codec.
{{.AccountCodecH264_Hp}}	Enables or disables H264_Hp codec.
{{.AccountCodecH264_Hp_Priority}}	The the priority of the H264_Hp codec.
{{.AccountCodecH263}}	Enables or disables H263 codec.
{{.AccountCodecH263_Priority}}	The the priority of the H263 codec.
{{.AccountCodecH263_P}}	Enables or disables H263_P codec.
{{.AccountCodecH263_P_Priority}}	The the priority of the H263_P codec.
{{.AccountCodecVp8}}	Enables or disables Vp8 codec.
{{.AccountCodecVp8_Priority}}	The the priority of the Vp8 codec.
Function key (<i>x</i> is the function key ID)	
{{.FunctionkeyType_x}}	The type of function key.
{{.FunctionkeySubtype_x}}	The subtype of function key.
{{.FunctionkeyLine_x}}	The extension that function key applies.
{{.FunctionkeyCodeValue_x}}	The feature code of function key.
{{.FunctionkeyValue_x}}	The object of function key.

Variable	Description
{{.FunctionkeyExtension_x}}	The number where the call can be picked up by function key.
{{.FunctionkeyCodeExtension_x}}	The pickup code applied for function key.
{{.FunctionkeyLabel_x}}	The label of function key which displayed on phone screen.
Gateway	
{{.KeyAsSend}}	Enable or disable Key as Send feature.
{{.SipVoipServerIdx}}	The VoIP server template ID.
{{.AdminPassword}}	The admin password.
{{.EnbLanSettings}}	Enable or disable LAN settings.
{{.Hostname}}	The host name.
{{.LanIpAddress}}	The primary IP address of LAN port.
{{.LanSubnetMask}}	The subnet mask of LAN port.
{{.LanGateway}}	The gateway of LAN Port.
{{.LanPrimaryDns}}	The primary DNS of LAN port.
{{.LanSecondaryDns}}	The secondary DNS of LAN Port.
{{.LanIpAddress2}}	The secondary IP address of LAN port.
{{.LanSubnetMask2}}	The secondary subnet mask of LAN port.
{{.PppoeUsername}}	The user name of PPPoE.
{{.PppoePassword}}	The password of PPPoE.

User Role

User Roles and Permissions

Yeastar P-Series PBX System allows super administrator to have a role-based control over the PBX features that are accessible and manageable on users' management portals. This topic describes what is a user role, and introduces the pre-defined user roles and their permissions.

What is a user role

A user role includes a set of permissions, which allows super administrator to control what PBX features users can manage on users' management portals.

Super administrator can assign user roles to employees based on their job duties, each user role has different permissions. For example, you can assign **Operator** to an employee who is responsible for security of PBX server and network; assign **Human Resource** to an employee who is responsible for dealing with employee profiles.

Pre-defined user roles

Yeastar P-Series PBX System has pre-defined user roles that cover the most common permission configurations. The pre-defined user roles and their permissions are as follows:

Table 19.

Role	Permission
Super administrator	Access and manage all the PBX features.  Note: The username of super administrator is created when you first configure the system, and the username is unchangeable.
Administrator	Access and manage all the PBX features except the followings: <ul style="list-style-type: none">• View Dashboard• Manage Role
Supervisor	No access to PBX features.
Operator	Access and manage all the features under Security and Maintenance modules. For more information, see Security and Maintenance .
Employee	No access to PBX features.
Human Resource	View and manage all the extensions.
Accounting	Access and manage Plan .

Create a User Role

If the pre-defined roles can not meet your need, you can create a user role and grant permissions to the role. This topic describes how to create a user role.

Create a new role

Based on an employee' job duty, you can create a user role and grant corresponding permissions.

1. Log in to the PBX web interface, go to **Extension and Trunk > Role**, click **Add**.
2. In the **Role Name** field, set a name to help you identify it.
3. Grant permissions to the user role.

For permission details, see [User Role Permissions](#).

4. Click **Save**.

Create a role by copying an existing role

You can create a role based on an existing user role, the new role automatically inherits permissions from the existing role. After copying permissions, you can add or remove permissions as needed.

1. Log in to the PBX web interface, go to **Extension and Trunk > Role**.
2. Create a role.
 - a. Click **Copy Role**.
 - b. In the **Choose a role to copy** drop-down list, select a role.
 - c. In the **Role Name** field, enter a name to help you identify the role.
 - d. Click **Save**.

The new role inherits permissions from the existing role.

3. Update permissions for the newly created role.
 - a. On **Role** list, click  beside the role that you have created.
 - b. Select or unselect the checkboxes of the desired permissions.

For permission details, see [User Role Permissions](#).

- c. Click **Save**.

What to do next

[Assign a Role to a User](#).

Assign a Role to a User

This topic describes how to assign a role to a user.

Prerequisites

[A user role is created.](#)

Procedure

1. Log in to the PBX web interface, go to **Extension and Trunk > Extension**.
2. On **Extension** list, select an extension, click .
3. On the **User** page, select a role from the drop-down list of **User Role**.
4. Click **Save** and **Apply**.

Result

If specific permissions are granted to the role, after the user logs in to Linkus Web Client, the user can go to management portal, and access specific system features.

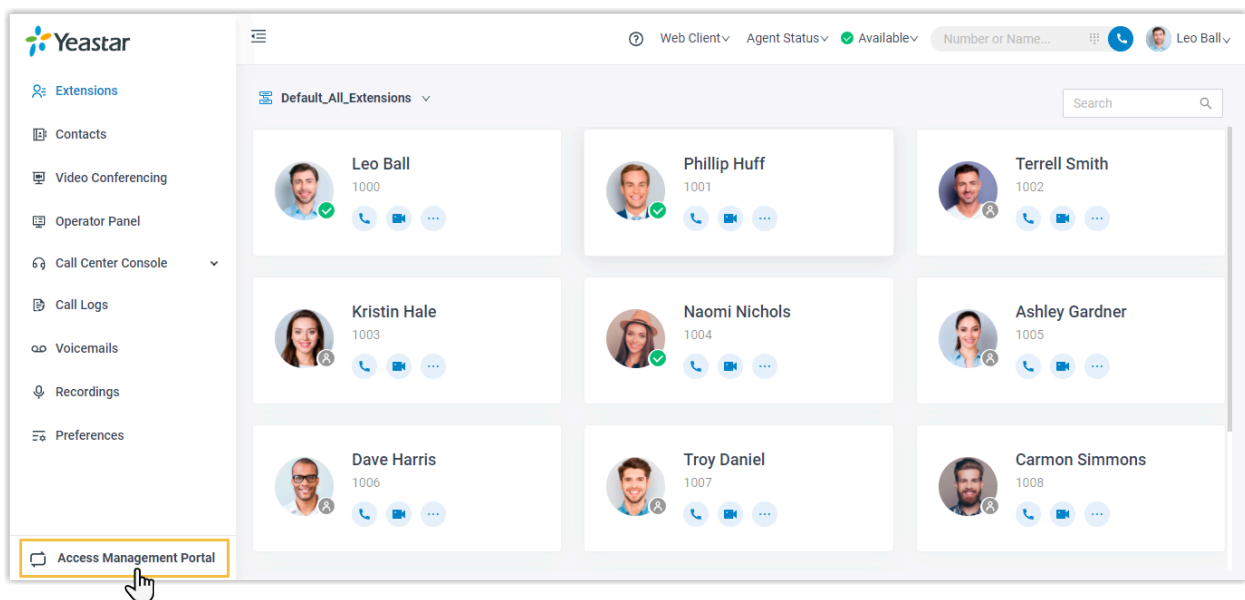

Manage User Roles

This topic describes how to edit or delete roles.

Edit a role

After creating a role, you can edit role permissions according to your needs.

1. Log in to the PBX web interface, go to **Extension and Trunk > Role**.
2. On **Role** list, select a role, click .
3. Edit the role name, or change role permissions according to your needs.

For permission details, see [User Role Permissions](#).

4. Click **Save**.

Delete roles

If you don't need roles, you can delete them. After roles are deleted, users with the roles assigned will have no role definition.

1. Log in to the PBX web interface, go to **Extension and Trunk > Role**.
2. Delete one or more roles according to your needs.
 - To delete a role, select a role, click  and **OK**.
 - To delete roles in bulk, select the checkboxes of the desired roles, click **Delete** and **OK**.

User Role Permissions

This topic describes all the available permissions that can be granted to a role.

Available permissions on Yeastar P-Series PBX System are as follows:

- [Outbound Call Permission](#)
- [Extension and Trunk](#)
- [Call Control](#)
- [Call Features](#)
- [Reports and Recordings](#)
- [Auto Provisioning](#)
- [PBX Settings](#)
- [System](#)
- [Security](#)
- [Maintenance](#)
- [Plan](#)

Outbound Call Permission

Specify users with the role assigned can use which outbound routes to make outbound calls.

Extension and Trunk

Specify the extensions that users with the role assigned can manage, and whether users can manage extension group or trunks.

Table 20.

Module	Permission
Extension	<ul style="list-style-type: none"> • All Extensions: View and manage all the extensions. For example, grant the permission to a human resource. If there are changes of employees, the human resource can update extensions timely. • All the other extensions of the same Extension Groups: Manage or send Linkus welcome emails to all the other extensions in the same extension group except the one that contains all the extensions. For example, grant the permission to a supervisor. The supervisor can view and manage his or her subordinates' extensions. • Specific Extensions: Manage or send Linkus welcome emails to specific extensions. For example, grant the permission to a leader. The leader can view and manage different departments' extensions. • Extension itself only: Manage or send Linkus welcome emails to his or her own extension.
Extension Group	Manage extension groups.
Trunks	Manage trunks.

Call Control

Specify one or more features that users with the role assigned can manage.

- **Inbound Route**
- **Outbound Route**
- **Emergency Number**
- **Business Hours and Holidays**

Call Features

Specify one or more features that users with the role assigned can manage.

- **Voicemail**
- **Feature Code**
- **IVR**
- **Ring Group**
- **Queue**
- **Conference**
- **Speed Dial**
- **Recording**

Reports and Recordings

Specify users with the role assigned can view or manage which extensions' CDR and recordings, and whether users can access call reports.

Table 21.

Module	Permission
CDR and Recording Files	Specify users with the role assigned can view which extensions' CDR and recordings. <ul style="list-style-type: none"> • All Extensions: View all extensions' CDR and recordings. • All the other extensions of the same Extension Groups: View CDR and recordings of all the other extensions of the same group except the one that contains all the extensions. • Specific Extensions: View CDR and recordings of specific extensions or extension.
	Specify how users with the role assigned can manage CDR. <ul style="list-style-type: none"> • Download • Delete
	Specify how users with the role assigned can manage recording files. <ul style="list-style-type: none"> • Play • Download • Delete
Call Reports	Specify whether users with the role assigned can access call reports.

Auto Provisioning

Specify whether users with the role assigned can manage **Auto Provisioning**.

PBX Settings

Specify whether users with the role assigned can manage the following features:

- **Preferences**
- **Voice Prompt**
- **SIP Settings**
- **Jitter Buffer**

System

Specify whether users with the role assigned can manage the following features:

- **Network**
- **Date and Time**
- **Email**

- **Storage**
- **Event Notification**

Security

Specify whether users with the role assigned can manage the following features:

- **Security Rules**
- **Security Settings**

Maintenance

Specify whether users with the role assigned can manage the following features:

- **Upgrade**
- **Backup and Restore**
- **Reboot**
- **Reset**
- **Operation Logs**
- **Troubleshooting**
- **System Logs**

Plan

Specify whether users with the role assigned can buy or enable free trial of Yeastar-provided plan.

Linkus Server

Linkus Overview

Yeastar Linkus is designed to keep you connected with colleagues and business anywhere and anytime. This topic describes Linkus server, Linkus client, Linkus client login methods, and Linkus events.

Linkus server

To get started with Linkus, you need to set up Linkus server and enable Linkus clients for users. Yeastar P-Series PBX System allows you to set up Linkus server in two ways:

- **Auto configuration by Remote Access Service**

Remote Access Service (RAS) is a subscription-based service designed for remote working. After RAS is subscribed, you can bind a Yeastar FQDN to the PBX, and the following functions will be provided:

 **Note:** RAS provides remote access, not remote control.

- # Secure connection
- # Remote access of PBX web
- # Network Address Translation (NAT) for Linkus service auto configured
- # Linkus server for remote access auto configured

For more information about Linkus auto configuration by RAS , see [Set up Linkus Server with Remote Access Service](#).

- **Manual configuration**

Manual configuration of Linkus remote server requires professional network knowledge.

 **Note:**

- # Weak network protection will cause SIP attacks.
- # Incorrect configurations may cause a one-way audio issue.

For more information about manual configuration, see [Manually Set up Linkus Server](#).

Linkus client

Yeastar P-Series PBX System supports the following Linkus clients:

- **Linkus Mobile Client**
- **Linkus Desktop Client**
- **Linkus Web Client**

For more information about **Linkus Mobile Client** and **Linkus Desktop Client**, see [Linkus Help Center](#).

For more information about **Linkus Web Client**, see [Linkus Web Client User Guide](#).

Linkus client login methods

Yeastar P-Series PBX System allows users to quickly log in to Linkus clients via a specific link or QR code, or manually log in by entering the provided credentials.

• Quick login

Login link: Provide users with login links so that they can quickly log in to Linkus clients.

Login QR code: Provide users with login QR codes so that they can quickly log in to Linkus Mobile Client.



You can copy and share login credential of a specific client with a user, or bulk send Linkus welcome emails to multiple users, which contain login credentials of all the Linkus clients.

For more information, see [Configure Linkus Welcome Email](#) and [Send Linkus Welcome Emails](#).

• Manual login

Depending on different kinds of Linkus server that you have set up, you need to provide different information for users to log in to Linkus clients.

Table 22.

Linkus Server	Mobile & Desktop Login Credentials	Web Client Login Credentials
Linkus Server (RAS)	# The FQDN that is bound with the PBX # Username Username can be extension number or email address, which depends on how you Configure Linkus Login Mode . # User password	
Linkus Server (Manual configuration)	# PBX's local IP address and local Linkus port # PBX's public IP address or domain name and external Linkus port # Username  Note: Username can be extension number or email address, which depends on how you Configure Linkus Login Mode . # User password	# PBX's local IP address and local web port # PBX's public IP address or domain name and external web port # Username  Note: Username can be extension number or email address, which depends on how you Configure Linkus Login Mode . # User password

Linkus events

Yeastar P-Series PBX System provides event notification feature, which records events in logs and notifies relevant contacts via specific notification methods when events occur.

Yeastar P-Series PBX System provides the following Linkus events:

- **Web User Login Success**
- **Web User Login Failed**
- **Linkus Client Login Failed**
- **Extension User Password Changed**
- **Web User Locked Out**
- **Linkus User Blocked Out**

For more information, see [Event Notification Overview](#) and [Configure Event Notifications](#).

Set up Linkus Server with Remote Access Service

After you subscribe Yeastar P-Series Enterprise Plan or Ultimate Plan to get Remote Access Service, users can remotely access Linkus Mobile Client and Desktop Client. To allow remote access to Linkus Web Client, you need to further configure a Yeastar-supplied Fully Qualified Domain Name (FQDN) on the system.

Background information

Remote Access Service (RAS) is included in both Yeastar P-Series Enterprise Plan and Ultimate Plan. You can subscribe either of the two plans to get RAS. With RAS, you can enjoy the following features:

- Linkus server is automatically set up for remote access with the PBX Serial Number.

 **Note:** Only remote access to Linkus Mobile Client and Desktop Client is supported. For remote access to Linkus Web Client, further network configurations are required.

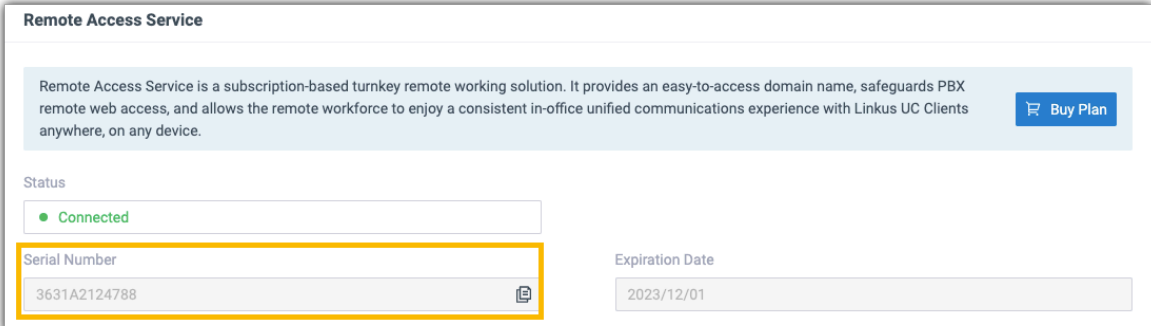

Remote Access Service

Remote Access Service is a subscription-based turnkey remote working solution. It provides an easy-to-access domain name, safeguards PBX remote web access, and allows the remote workforce to enjoy a consistent in-office unified communications experience with Linkus UC Clients anywhere, on any device. [Buy Plan](#)

Status

● Connected

Serial Number: 3631A2124788 

Expiration Date: 2023/12/01

- A Fully Qualified Domain Name (FQDN) can be quickly set up to complete the remote working solution with all Linkus clients (Mobile Client, Desktop Client, and Web Client).

Procedure

1. Log in to the PBX web interface, go to **System > Network > Public IP and Ports**.
2. Turn on **Public IP (NAT)**.
3. In the drop-down list of **NAT Type**, select **Yeastar FQDN**.
4. In the **Fully Qualified Domain Name (FQDN)** field, select a domain name then enter a hostname.

For example, select domain name *ras.yeastar.com* and enter hostname *yeastar*, you will get an FQDN *yeastar.ras.yeastar.com*

 **Note:** Think twice before you enter the hostname. The FQDN cannot be changed after you save the configurations.

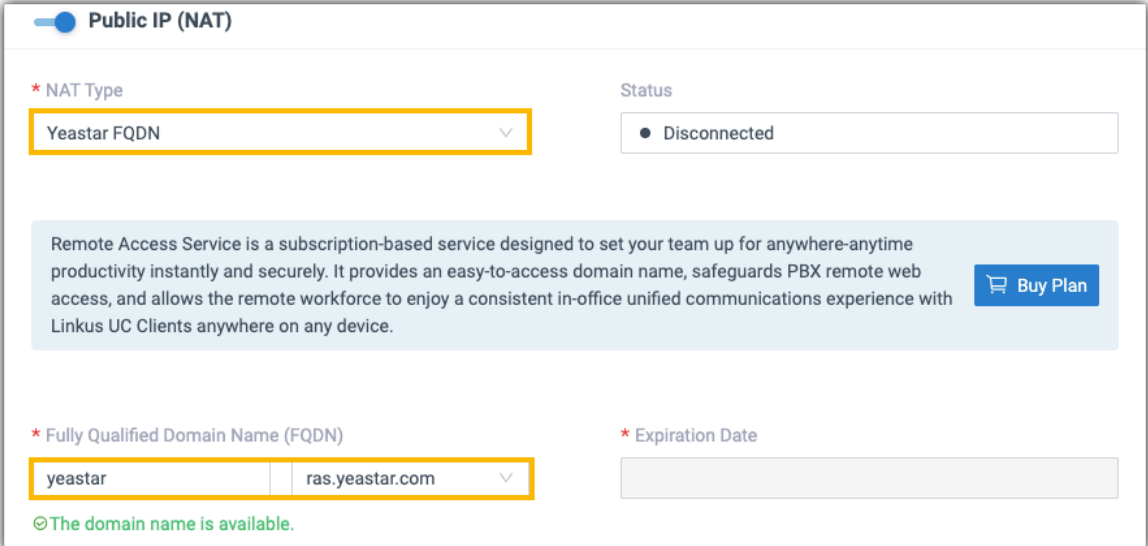

Public IP (NAT)

* NAT Type: Yeastar FQDN

Status: Disconnected

Remote Access Service is a subscription-based service designed to set your team up for anywhere-anytime productivity instantly and securely. It provides an easy-to-access domain name, safeguards PBX remote web access, and allows the remote workforce to enjoy a consistent in-office unified communications experience with Linkus UC Clients anywhere on any device. [Buy Plan](#)

* Fully Qualified Domain Name (FQDN): yeastar | ras.yeastar.com

* Expiration Date: [Empty]

☺ The domain name is available.

5. Click **Save**.

Result

- Linkus server is automatically set up for remote access with the FQDN. The following information is displayed on the **Linkus Server** page:

Remote Access Service

Remote Access Service is a subscription-based turnkey remote working solution. It provides an easy-to-access domain name, safeguards PBX remote web access, and allows the remote workforce to enjoy a consistent in-office unified communications experience with Linkus UC Clients anywhere, on any device. [Buy Plan](#)

Status

● Connected

Domain Name

yeastar.ras.yeastar.com

Expiration Date

2023/12/01

- # **Status:** Connected, which means that Linkus server is set up successfully.
- # **Domain Name:** The domain name is used as a unique identifier for Linkus remote access.
- # **Expiration Date:** When the service will expire.

- Users can use Linkus (Mobile Client, Desktop Client, and Web Client) anywhere any-time.

Note: For Linkus Mobile Client and Desktop Client, the App version should be updated:

- # Linkus Android version: 3.6.9 or later
- # Linkus iOS version: 3.6.8 or later
- # Linkus Windows version: 2.4.8 or later
- # Linkus MacOS version: 2.4.8 or later

What to do next

- [Configure Linkus Login Mode](#)
- [Enable Linkus clients for users](#)

Manually Set up Linkus Server

This topic describes how to manually set up Linkus server according to different network scenarios.

PBX is behind a router

If your PBX is behind a router and Linkus communicates with the PBX through the network interface that is configured with a private IP, you need to forward Linkus-related ports on your router and configure SIP NAT settings on your PBX.

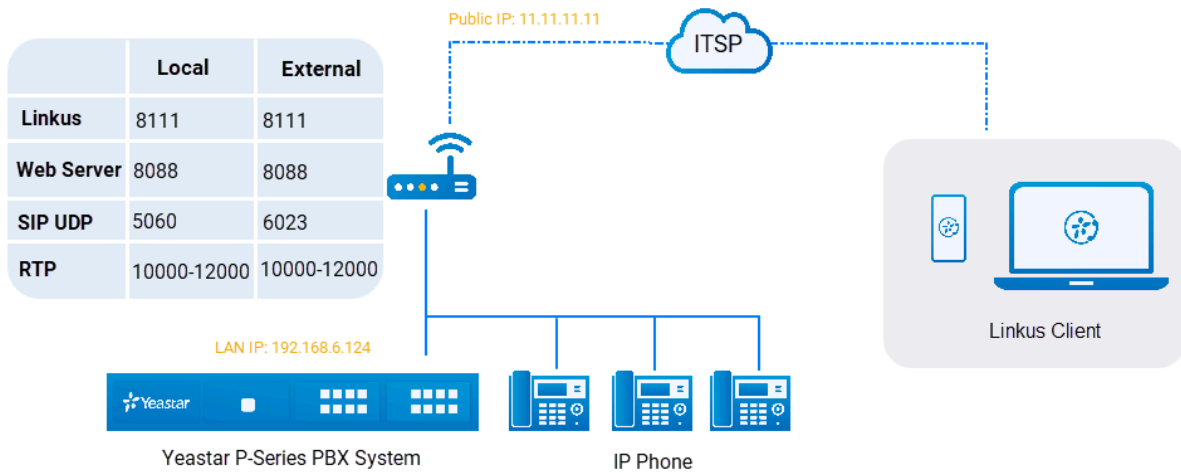

Procedure

Based on the above network topology diagram, you can configure Linkus server as follows:

1. Log in to the PBX web interface, go to **System > Network > Service Ports** to [check and manage local service ports](#) on your PBX system.
2. Forward Linkus-related ports on your router.

In this example, forward the following ports:

Service Port	Local Port	External Port
Linkus Service Port	TCP&UDP 8111	TCP&UDP 8111
Web Server Port	TCP 8088	TCP 8088
SIP Registration Port	UDP 5060	UDP 6023
RTP Ports	UDP 10000-12000	UDP 10000-12000

3. Configure SIP NAT on your PBX for remote access.

The [SIP NAT settings](#) are configured to ensure that SIP data can be transmitted correctly between the PBX and the public Internet.

Public IP (NAT)

* NAT Type
Public IP Address

* Public IP Address

Local Network Identification

Network Number	Subnet Mask	Operations
<input type="text" value="192.168.6.0"/>	<input type="text" value="255.255.255.0"/>	<input type="button" value="🗑"/>

- a. On the PBX web interface, go to **System > Network > Public IP and Ports**.
 - b. Enable **Public IP (NAT)**.
 - c. In the **NAT Type** drop-down list, select **Public IP Address**.
 - d. In the **Public IP Address** field, enter the public IP address. In this example, enter *11.11.11.11*.
 - e. In the **Local Network Identification** section, click **+ Add IP** to add all your local network. In this example, enter *192.168.6.0/255.255.255.0*.
 - f. In the **NAT Mode** drop-down list, select **Yes**.
4. Enter external SIP port, web server port, and Linkus service port, which helps the router to direct appropriate traffic from the Internet to the PBX.
 - **External SIP UDP Port:** In this example, enter *6023*.
 - **External Linkus Port:** In this example, enter *8011*.
 - **External Web Server Port:** In this example, enter *8088*.
 5. Click **Save**.

Result

Linkus server for both local access and remote access is set up.

What to do next

- [Configure Linkus Login Mode](#)
- [Enable Linkus clients for users](#)

PBX is connected to the ISP router directly

If the PBX is connected to an Internet Service Provider (ISP) router, the Linkus server is ready to be accessed remotely.

 **Note:** In this network scenario, you do NOT need to do port forwarding on your router or configure SIP NAT settings on your PBX.

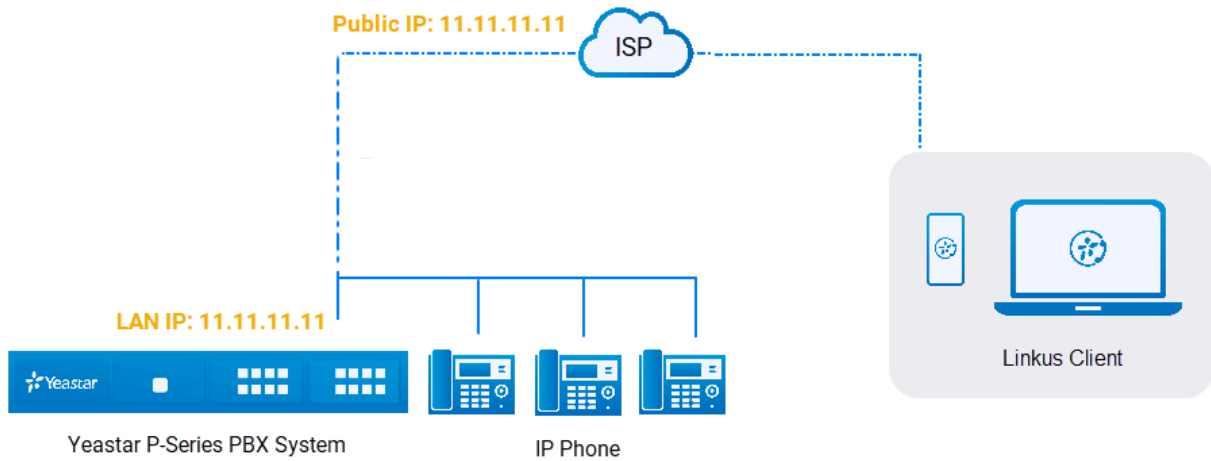

What to do next

- [Configure Linkus Login Mode](#)
- [Enable Linkus clients for users](#)

PBX is connected to a VPN network

If your PBX is connected to a VPN network, the Linkus server is ready to be accessed by the VPN network.

Note: In this network scenario, you do NOT need to do port forwarding on your router or configure SIP NAT settings on your PBX.

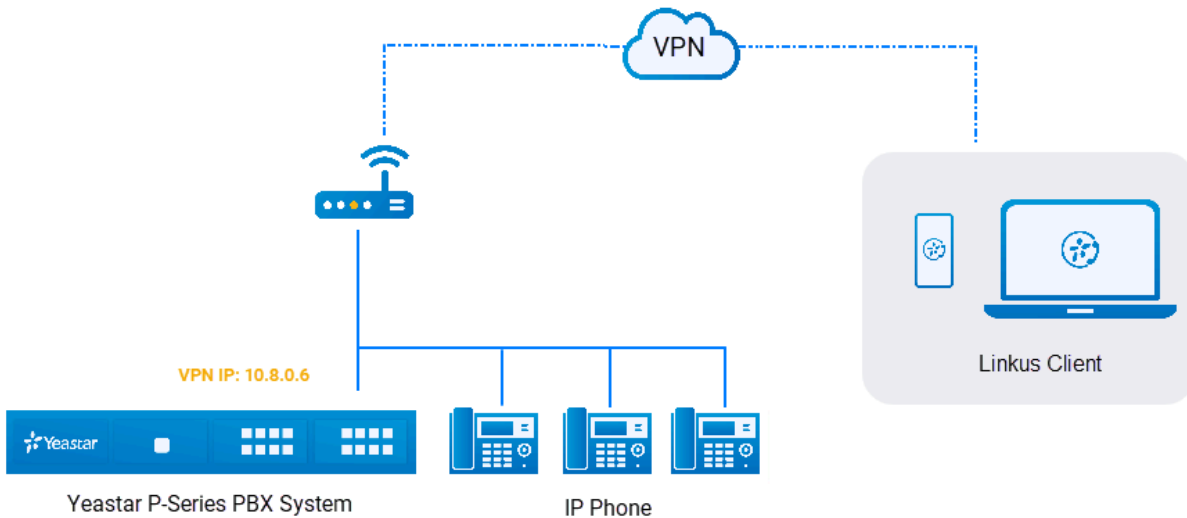

What to do next

- [Configure Linkus Login Mode](#)
- [Enable Linkus clients for users](#)

Configure Linkus Login Mode

Yeastar P-Series PBX System supports two login modes for Linkus clients. You can decide how users can manually log in to Linkus clients.

Procedure

1. Log in to the PBX web interface, go to **Extension and Trunk > Extension**.
2. Click **Linkus Server** tab.
3. In the **Linkus Client Login Mode** section, select the checkboxes of the desired login modes.
 - **Extension Number**: Use an extension number as the username.
 - **Email Address**: Use an email address as the username.
4. Click **Save**.



Note: The email address is associated with user's extension number.

Enable Linkus Clients for Users

After Linkus server is set up, you need to enable Linkus clients for users, so that users can log in to Linkus and use it. This topic describes how to enable Linkus clients for a user.

Procedure

1. Log in to the PBX web interface, go to **Extension and Trunk > Extension**.
2. Select a desired extension, click .
3. Click **Linkus Clients** tab.
4. Enable the following Linkus clients for the user.
 - **Linkus Mobile Client**
 - **Linkus Desktop Client**
 - **Linkus Web Client**

Result

- **Linkus Mobile Client**: The status shows , and a login QR code is displayed on the right.
- **Linkus Desktop Client**: The status shows , and a login link is displayed on the right.
- **Linkus Web Client**: The status shows .

What to do next

Send Linkus login credentials to users.

- To send login credentials in bulk, you can send Linkus welcome emails to users, which contain login credentials of all the Linkus clients.

For more information, see [Send Linkus Welcome Emails](#).

- To send login credential of a specific Linkus client to a user, do the followings:
 - # **Linkus Mobile Client:** Provide user with the login QR code.

 **Note:** The QR code can be used ONLY once, and is valid for 24 hours.



- # **Linkus Desktop Client:** Provide user with the login link.

 **Note:** The link can be used ONLY once, and is valid for 24 hours.



- # **Linkus Web Client:** Provide user with the following information:

- # [The FQDN that is bind with the PBX system](#)

- # Username

The username can be extension number or email address, which depends on how you configure login mode. For more information, see [Configure Linkus Login Mode](#).

- # User password

Configure Linkus Welcome Email

Before sending Linkus welcome emails to provide users with login credentials of all the Linkus clients, you may need to configure Linkus welcome email.

Background information

By default, Yeastar P-Series PBX System sends Linkus welcome emails in the language that you have set in [system email template](#). A welcome email contains the following information:

- **Extension information:** Include extension number and voicemail PIN.
- **Login instructions and credentials:** Include login instructions and credentials for all the Linkus clients.

Procedure

Yeastar P-Series PBX System provides a default email template, you can also customize your own template as follows.

1. Log in to the PBX web interface, go to **Extension and Trunk > Extension**.
2. Click **Linkus Server** tab.
3. Click **Email Templates** tab.
4. Customize email template.
 - a. In the **Template** drop-down list, select **Custom**.
 - b. Edit email subject and content according to your needs.
 - c. Click **Save**.

What to do next

[Send Linkus Welcome Emails](#)

Send Linkus Welcome Emails

To provide multiple users with Linkus login credentials, you can send Linkus welcome emails. This topic describes how to send Linkus welcome emails.

Prerequisites

- Make sure the [system email server](#) works.
- Make sure Linkus server has been set up.

For more information about the configurations, see [Set up Linkus Server with Remote Access Service](#) or [Manually Set up Linkus Server](#).

- You have configured email addresses for the desired extensions.
- You have enabled at least one Linkus client for the desired extensions.

Procedure

1. Log in to the PBX web interface, go to **Extension and Trunk > Extension**.
2. On **Extension** list, select the checkboxes of the desired extensions, click **Welcome Email**.

The system sends welcome emails to the extensions' email addresses.

Result

- If all the welcome emails are sent successfully, the web interface displays the following confirmation.

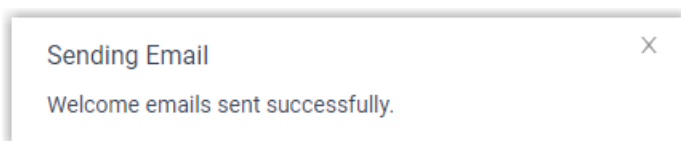

- If there are any emails failed to be sent, you will get an error prompt like the following figure. Click **Email Sent Logs** to check the error.

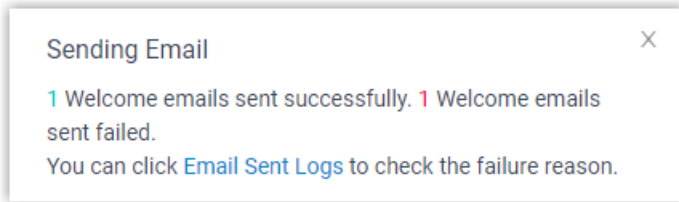

Enable or Disable Push Notifications for Linkus Mobile Client

This topic describes how to enable or disable push notifications for Linkus Mobile Client.

Background information

Push notification is an important tool for showing users alert messages and bringing them back to Linkus Mobile Client. By default, users can receive Linkus notifications anywhere and anytime, such as missed calls, new voicemail messages and so on.

Note: If Linkus server is set up only in local network, in case users can not connect to calls when they are out of the office, you can disable push notifications for them.

Procedure

1. Log in to the PBX web interface, go to **Extension and Trunk > Extension**, edit the desired extension.
2. Click **Presence** tab.
3. To configure push notifications for a specific presence, select one on the status bar.

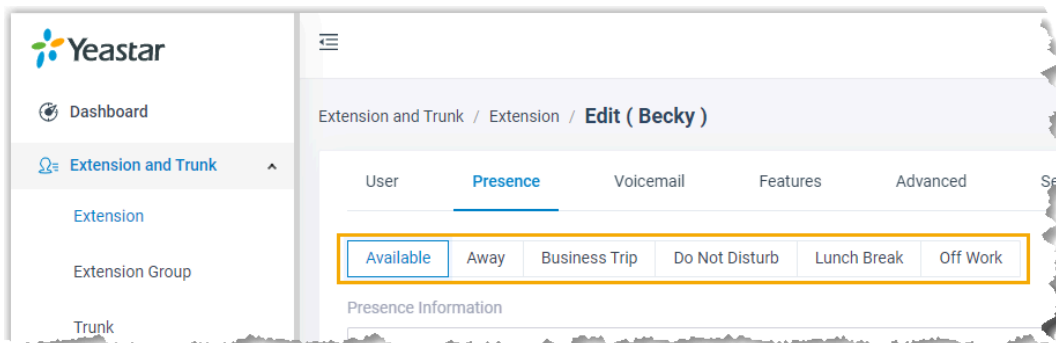

4. In the **Options** section, select or unselect the checkbox of **Accept Push Notifications**.
5. To configure push notification for other presence status, repeat **step3-4**.
6. Click **Save**.

Operator Panel

Manage Operator Panel

This topic describes instruction on setting up Operator Panel for extension user.

What is Operator Panel

Operator Panel is a web-based utility integrated with the Yeastar Linkus Web Client. It is designed for employee who needs to manage and transfer a large number of calls, such as receptionist or agent manager.

For more information of managing calls on Operator Panel, see [Operator Panel User Guide](#).

User types and permissions

There are three user types available for you to assign to an extension group member: manager, user, and custom. What they can do on Operator Panel depends on the following permission.

The following table displays the permissions available to different user types of extension group members.

 **Note:** By default, an extension group manager has all permissions to manage calls on Operator Panel, while the extension group users have no permission to access and use the Operator Panel.

Permission	Extension Group Manager	Extension Group User	Custom role of Extension Group
Switch group members' presence	#	#	#
Call distribution management (Redirect, Transfer, Drag and Drop operation)	#	#	#
Pick up or hang up other extensions' calls	#	#	#
Call monitoring operations (Listen, Whisper, Barge-in)	#	#	#
Call parking operations (Park, Retrieve)	#	#	#
Route calls directly from IVR regardless of the IVR menu	#	#	#
Switch Business Hours and Holidays status	#	×	#

Permission	Extension Group Manager	Extension Group User	Custom role of Extension Group
Switch extensions' recording status	#	x	#

Related information

[Assign a User Type to a Group Member](#)

[View or Change Permissions for Group Members](#)

[View or Change a Member's User Type in Multiple Groups](#)

Trunk

Trunk Overview

A trunk is a telephone line that connects your PBX to the users in the external world. This topic gives an overview of various trunks supported on the Yeastar P-Series PBX System and describes status of different trunks.



Trunk types





The following table shows supported trunk types on Yeastar P-Series PBX System.

Category	Trunk Type	Requirement
SIP Trunk	SIP Register	No additional telephony module is required.
	SIP Peer	
	SIP Account	
Analog Trunk	FXO	SO module or O2 module.
Cellular Trunk	GSM	GSM module.
	3G	3G module.
	4G LTE	4G LTE module.
ISDN E1/T1/J1	E1	EX30 expansion board.
	T1	 Note: E1/T1/J1 trunk is only supported on Yeastar P560 and P570.
	J1	
ISDN BRI	BRI	B2 module.





Trunk status

SIP Trunk status







Status	Description
	Disabled.
	Unreachable.
	Registration failed. <ul style="list-style-type: none">• Authentication failed.• Transport type inconsistent.



Status	Description
	• Rejected.
	Registering.
	Registered.
	Unmonitored.
	Busy. Maximum channels reached.

FXO Trunk status



Status	Description
	Failure: Malfunction in FXO interface, please examine the relevant interface and module.
	Unavailable: No PSTN line plugged in FXO interface.
	Available.
	Busy.

GSM/3G/4G LTE Trunk status



Status	Description
	Failure: Malfunction in module, please examine the relevant module.
	Unavailable: The module is powered off.
	Unavailable: No SIM card inserted.
	Unavailable: No signal.
	Unavailable: PIN/PUK error.
	Unavailable: Cellular network registration failed.  Note: Try to manually select the correct carrier setting to fix this issue.

Status	Description
	Available, the icon shows the signal strength.
	Busy, the icon shows the signal strength.

E1/T1/J1 Trunk status

Status	Description
	<p>Failure. It may caused by the following problems on Physical layer:</p> <ul style="list-style-type: none"> • Malfunction in interface/module. Check the relevant interface/module. • No trunk plugged in. • Service provider doesn't activate the trunk.
	<p>Failure. It may caused by the following problems on Data Link layer:</p> <ul style="list-style-type: none"> • Incorrect protocol layer configuration. • Service provider doesn't activate the trunk.
	Available.

BRI Trunk status

Status	Description
	<p>Failure. It may caused by the following problems on Physical layer:</p> <ul style="list-style-type: none"> • Malfunction in interface/module. Check the relevant interface/module. • No trunk plugged in. • Service provider doesn't activate the trunk.
	<p>Failure. It may caused by the following problems on Data Link layer:</p> <ul style="list-style-type: none"> • Incorrect protocol layer configuration. • Service provider doesn't activate the trunk.
	Available.

SIP Trunk

SIP Trunk Overview

A SIP trunk is a virtual telephone line offered by an Internet Telephony Service Provider (ITSP). Through a SIP trunk, users can make and receive calls over the internet.

Terminology

SIP

Session Initiation Protocol (SIP) is a multimedia communication protocol developed by the Internet Engineering Task Force (IETF), an application-layer control (signaling) protocol for creating, modifying, and terminating sessions with one or more participants.

ITSP

An Internet Telephony Service Provider (ITSP) is a provider of VoIP telephone service, also known as VoIP service provider.

SIP Trunk Types

Yeastar P-Series PBX System supports the following SIP trunk types:

SIP Register Trunk

Registration-based SIP trunk that uses username and password for registration with SIP providers.

SIP Peer Trunk

IP-based SIP trunk that uses IP address and port of PBX for authentication.

SIP Account Trunk

SIP Account Trunk is designed for connection between Yeastar P-Series PBX System and other devices. Yeastar P-Series PBX System will act as a VoIP account provider, the other device should register this account to connect to Yeastar P-Series PBX System.

SIP trunk creation methods

Create a SIP trunk by a template

Yeastar P-Series PBX System supports leading ITSP across the globe, you can use the pre-configured ITSP templates included in Yeastar P-Series PBX System to set up a SIP trunk quickly and easily. For more information, see [Create a SIP Trunk from a Template](#).

 **Note:** Check tested and supported ITSP from [ITSP partner page](#).

Create a general SIP trunk

If your ITSP has not undergone an interoperability test by Yeastar, you can set up a general SIP trunk.

For more information, see the following topics:

- [Create a SIP Register Trunk](#)
- [Create a SIP Peer Trunk](#)

Create a SIP Trunk

Create a SIP Trunk from a Template

Yeastar has tested leading ITSP across the globe and provides configuration templates for the tested and certificated ITSP. If a template is provided for your ITSP on the PBX, you can quickly create a SIP Trunk by the template.

Prerequisites

- Check if your ITSP is tested and supported by Yeastar from [ITSP partner page](#).
- Your PBX can connect to the ITSP.

Procedure

1. Log in to the PBX web interface, go to **Extension and Trunk > Trunk**, click **Add**.
2. In the **Basic** section, configure the following settings:
 - **Name:** Enter a name to help you identify it.
 - **Trunk Status:** Select **Enabled**.
 - **Select ITSP Template:** Select your country.
 - **ITSP:** Select your ITSP.

The trunk details are displayed automatically in the **Detailed Configuration** section.

- If the trunk type is displayed as **Register Trunk**, configure the following settings:
 - # **Username:** Enter the username provided by the ITSP.
 - # **Password:** Enter the password provided by the ITSP.
 - # **Authentication Name:** Optional. Authentication name is used for SIP authentication. If the ITSP provides an authentication name, enter the name.
 - If the trunk type is displayed as **Peer Trunk**, leave the settings as default.
3. **Optional:** If you have purchased DID numbers from the ITSP, click **DIDs/DDIs** tab to configure the DID numbers for the trunk.
 - a. Click **Add**.
 - b. In the pop-up window, configure the following settings:
 - **DID/DDI:** Enter the provided DID number.

- **DID/DDI Name:** Optional. Enter a name to distinguish inbound calls by DID numbers.

The name will be displayed on the called party's device when the DID number is dialed.

- c. Click **Save**.
- d. To add more DID numbers, repeat **step a - c**.

For more information of DID configurations, see [Configure DID Numbers on a Trunk](#).

4. Click **Save** and **Apply**.

Result

Go to **Extension and Trunk > Trunk** to check the trunk status on the trunk list page.

If the status shows , the trunk is registered successfully.

For more information of SIP trunk status, see [SIP Trunk status](#).

What to do next

- To receive inbound calls through the trunk, you need to select this trunk to one or more inbound routes. For more information, see [Set up an Inbound Route](#).
- To make outbound calls through the trunk, you need to select this trunk to one or more outbound routes. For more information, see [Set up an Outbound Route](#).

Create a SIP Register Trunk

This topic gives a configuration example to describe how to create a general SIP Register Trunk, which can be applied to all kinds of SIP Register Trunk.

Background information

Assume that you have bought a SIP account from the ITSP ABC, and the trunk information is displayed as below.

- **Provider domain:** abc.provider.com
- **Protocol:** SIP
- **Registration Port:** 5060
- **Transport:** UDP
- **Username:** 254258255
- **Authentication name:** 254258255
- **Password:** 05JsOmsIS54SYh

Prerequisites

- You have purchased a SIP account from an ITSP and a username and a password are offered.
- Your PBX can connect to the ITSP.

Procedure

1. Log in to the PBX web interface, go to **Extension and Trunk > Trunk**, click **Add**.
2. In the **Basic** section, configure the following settings:
 - **Name:** Enter a name to help you identify it.
 - **Trunk Status:** Select **Enabled**.
 - **Select ITSP Template:** Select **General**.
3. In the **Detailed Configuration** section, select the trunk type and enter the SIP information that is provided by the ITSP.
 - **Trunk Type:** Select **Register Trunk**.
 - **Transport:** Select the transport provided by the ITSP. In this example, select **UDP**.
 - **Hostname/IP:** Enter the domain name or IP address of the ITSP. In this example, enter *abc.provider.com*.
 - **Port:** Enter the provided registration port. In this example, enter *5060*.
 - **Domain:** Enter the domain name or IP address of the ITSP. In this example, enter *abc.provider.com*.
 - **Username:** Enter the provided user name. In this example, enter *254258255*.
 - **Password:** Enter the provided password. In this example, enter *05JsOms-IS54SYh*.
 - **Authentication Name:** Enter the provided authentication name. In this example, enter *254258255*.

 **Note:** In most cases, authentication name is the same as the user name.

 - **Enable Outbound Proxy:** Optional. If the trunk is configured to use an outbound proxy server, when users make outbound calls through this trunk, all the SIP packets will be sent to the outbound proxy server.

 **Note:** Contact your ITSP to check if outbound proxy is supported, then configure outbound proxy settings under the ITSP's guidance.
4. **Optional:** If you have purchased DID numbers from the ITSP, click **DIDs/DDIs** tab to configure the DID numbers for the trunk.
 - a. Click **Add**.
 - b. In the pop-up window, configure the following settings:
 - **DID/DDI:** Enter the provided DID number.
 - **DID/DDI Name:** Optional. Enter a name to distinguish inbound calls by DID numbers.

The name will be displayed on the called party's device when the DID number is dialed.

- c. Click **Save**.
- d. To add more DID numbers, repeat **step a - c**.

For more information of DID configurations, see [Configure DID Numbers on a Trunk](#).

5. **Optional:** Click **Advanced, Inbound Caller ID Reformatting, Outbound Caller ID, or SIP Headers** tab to configure other settings.
6. Click **Save** and **Apply**.

Result

Go to **Extension and Trunk > Trunk** to check the trunk status on the trunk list page.

If the status shows , the trunk is registered successfully.

For more information of SIP trunk status, see [SIP Trunk status](#).

What to do next

- To receive inbound calls through the trunk, you need to select this trunk to one or more inbound routes. For more information, see [Set up an Inbound Route](#).
- To make outbound calls through the trunk, you need to select this trunk to one or more outbound routes. For more information, see [Set up an Outbound Route](#).

Create a SIP Peer Trunk

This topic gives a configuration example to describe how to create a general SIP Peer Trunk, which can be applied to all kinds of SIP Peer Trunk.

Background information

Assume that you have bought a SIP account from the ITSP ABC, and the trunk information is displayed as below.

- **Provider domain:** abc.provider.com
- **Protocol:** SIP
- **Registration Port:** 5060
- **Transport:** UDP

Prerequisites

- You have purchased a SIP account from an ITSP and no username and password is offered but only a domain name or IP address.
- Your PBX can connect to the ITSP.

Procedure

1. Log in to the PBX web interface, go to **Extension and Trunk > Trunk**, click **Add**.
2. In the **Basic** section, configure the following settings:
 - **Name**: Enter a name to help you identify it.
 - **Trunk Status**: Select **Enabled**.
 - **Select ITSP Template**: Select **General**.
3. In the **Detailed Configuration** section, select the trunk type and enter the SIP information that is provided by the ITSP.
 - **Trunk Type**: Select **Peer Trunk**.
 - **Transport**: Select the transport provided by the ITSP. In this scenario, select **UDP**.
 - **Hostname/IP**: Enter the domain name or IP address of the ITSP. In this scenario, enter *abc.provider.com*.
 - **Port**: Enter the provided registration port. In this scenario, enter *5060*.
 - **Domain**: Enter the domain name or IP address of the ITSP. In this scenario, enter *abc.provider.com*.
4. **Optional**: If you have purchased DID numbers from the ITSP, click **DIDs/DDIs** tab to configure the DID numbers for the trunk.
 - a. Click **Add**.
 - b. In the pop-up window, configure the following settings:
 - **DID/DDI**: Enter the provided DID number.
 - **DID/DDI Name**: Optional. Enter a name to distinguish inbound calls by DID numbers.

The name will be displayed on the called party's device when the DID number is dialed.
 - c. Click **Save**.
 - d. To add more DID numbers, repeat **step a - c**.

For more information of DID configurations, see [Configure DID Numbers on a Trunk](#).

5. Click **Save** and **Apply**.

Result

Go to **Extension and Trunk > Trunk** to check the trunk status on the trunk list page.

If the status shows , the trunk is registered successfully.

For more information of SIP trunk status, see [SIP Trunk status](#).

What to do next

- To receive inbound calls through the trunk, you need to select this trunk to one or more inbound routes. For more information, see [Set up an Inbound Route](#).
- To make outbound calls through the trunk, you need to select this trunk to one or more outbound routes. For more information, see [Set up an Outbound Route](#).

Create a SIP Account Trunk

A SIP Account is used for the other device to register with Yeastar P-Series PBX System. In this way, Yeastar P-Series PBX System and the other device are connected. This topic describes how to create a SIP Account Trunk on Yeastar P-Series PBX System.

Prerequisites

To connect a third-party device with Yeastar P-Series PBX System by a SIP Account Trunk, you need to make sure that there is no duplicate extension numbers on both sides.

Procedure

1. Log in to the PBX web interface, go to **Extension and Trunk > Trunk**, click **Add**.
2. In the **Basic** section, configure the following settings:
 - **Name:** Enter a name to help you identify it.
 - **Trunk Status:** Select **Enabled**.
 - **Select ITSP Template:** Select **General**.
3. In the **Detailed Configuration** section, select the trunk type and define the information of the SIP account.

 **Note:** You can leave the default SIP information or edit the information according to your needs.

- **Trunk Type:** Select **Account Trunk**.
 - **Transport:** Select a transport. The following options are supported:
 - # **UDP**
 - # **TCP**
 - # **TLS**
 - **Username:** Enter a username for the SIP account.
 - **Password:** Enter a password for the SIP account.
 - **Authentication Name:** Enter an authentication name for the SIP account.
4. **Optional:** Click **Advanced**, **Inbound Caller ID Reformatting**, **Outbound Caller ID**, or **SIP Headers** to configure other settings.
 5. Click **Save** and **Apply**.

What to do next

- Register the SIP Account Trunk on the third-party software or device. Depending on the network of the third-party software or device, you need to provide different information:
 - # **Same local network as Yeastar P-Series PBX System**
 - # SIP Account Trunk details
 - # Local IP address of PBX
 - # Local SIP port of PBX
 - # **Different network from Yeastar P-Series PBX System**

- # SIP Account Trunk details
- # Public IP address or domain name of PBX
- # External SIP port of PBX

- To receive inbound calls through the trunk, you need to select this trunk to one or more inbound routes. For more information, see [Set up an Inbound Route](#).
- To make outbound calls through the trunk, you need to select this trunk to one or more outbound routes. For more information, see [Set up an Outbound Route](#).

Result

Go to **Extension and Trunk > Trunk** to check the trunk status on the trunk list page.

If the SIP Account Trunk is successfully registered on the third-party software or device, the trunk status will show , which also indicates that the two devices are connected.

For more information of SIP trunk status, see [SIP Trunk status](#).

Manage SIP Trunks

After you create SIP trunks, you can edit or delete the SIP trunks.

Edit a SIP trunk

1. Log in to the PBX web interface, go to **Extension and Trunk > Trunk**.
2. On the Trunk list page, select a trunk and click .
3. Click the desired tab to edit the relevant settings.
4. Click **Save** and **Apply**.

Delete SIP trunks

1. Log in to the PBX web interface, go to **Extension and Trunk > Trunk**.
2. To delete a SIP trunk, do the followings:
 - a. Click  beside the trunk.
 - b. Click **Yes** in the pop-up dialog box to confirm.
3. To delete multiple SIP trunks, do the followings:
 - a. Select checkboxes of the desired trunks.
 - b. Click **Delete**.
 - c. Click **Yes** in the pop-up dialog box to confirm.

Export and Import SIP Trunks

The SIP trunks configured on Yeastar P-Series PBX System can be exported and saved as a template. You can fill in desired SIP trunks in the exported file, and import the file to PBX again. This topic describes how to export and import SIP trunks.

Background information

Only Peer Trunks and Register Trunks can be imported.

Export all SIP trunks

You can export all SIP trunks to a CSV file, and then make additions, removals, and changes to the file.

1. Log in to the PBX web interface, go to **Extension and Trunk > Trunk**.
2. Click **Export**.

A CSV file is saved to your computer. To check and edit parameters in the CSV file, see [Trunk Parameters](#).

Import SIP trunks

We recommend that you export SIP trunks data to a CSV file first, and use the file as a template to start with. In this way, you can save time and effort.

Prerequisites

Requirements of an imported file:

- **Format:** UTF-8 .CSV
- **Size:** Less than 50MB
- **File name:** Less than 127 characters
- **Import parameters:** Ensure that the import parameters meet requirements. For more information , see [Trunk Parameters](#).

Procedure

1. Log in to the PBX web interface, go to **Extension and Trunk > Trunk**.
2. Click **Import**.
3. In the pop-up window, click **Browse**, and select your CSV file.
4. Click **Import**.

The trunks in the CSV file will be displayed in the **Trunk** list.

SIP Trunk Settings

This topic describes all the settings on a SIP trunk for reference.

Basic settings

Basic	
Setting	Description
Name	Give this trunk a name to help you identify it.
Trunk Status	Enable or disable the trunk.
Select ITSP Template	Select the country of your ITSP.  Note: If no SIP trunk template is provided for your ITSP, select General .
ITSP	Select your ITSP from the list of certified SIP trunk providers.

Detailed Configuration	
Setting	Description
Trunk Type	Select a trunk type: <ul style="list-style-type: none"> • Register Trunk • Peer Trunk • Account Trunk
Register Trunk	
Transport	Select the transport that is provided by the ITSP.
Hostname/IP	Enter the IP address or the domain of the ITSP.
Port	Enter the SIP port provided by the ITSP.
Domain	Enter the IP address or the domain of the ITSP.
Username	Enter the username to register to the ITSP.
Authentication Name	Enter the authentication name to register to the ITSP.
Password	Enter the password that is associated with the username.
Enable Outbound Proxy	If the trunk is configured to use an outbound proxy server, when users make outbound calls through this trunk, all the SIP packets will be sent to the outbound proxy server.  Note: Contact your ITSP to check if they supports outbound proxy, then configure outbound proxy settings under their guidance.
Peer Trunk	
Transport	Select the transport that is provided by the ITSP.
Hostname/IP	Enter the IP address or the domain of the ITSP.
Port	Enter the SIP port provided by the ITSP.
Domain	Enter the IP address or the domain of the ITSP.

Detailed Configuration	
Setting	Description
Account Trunk	
Protocol	Select the protocol for a third-party device to register with.
Transport	Select the transport for a third-party device to register with.
Username	Specify a username for the trunk.  Note: The username is regarded as the trunk number.
Authentication Name	Specify an authentication name for a third-party device to register with.
Password	Specify a password that is associated with the username.

Advanced settings

The advanced settings of VoIP trunk requires professional knowledge of SIP protocol. Incorrect configurations may cause calling issues. It is wise to leave the default settings provided on the SIP trunk page. However, for a few fields, you need to change them to suit your situation.

The following settings are included on the **Advanced** page.

- [Codec Setting](#)
- [VoIP Setting](#)
- [Call Restriction](#)

Codec Setting

Each newly created SIP trunk has a default preferred codec list. However, the default codec list may not match the codecs supported by your ITSP. To maximize the quality of calls and the amount of bandwidth used for calls, you can configure your preferred codec list to match the settings that your ITSP supports.

Yeastar P-Series PBX System supports the following codecs:

- u-law
- a-law
- G729A
- GSM
- H264
- H261
- H263
- H263P
- iLBC
- G722

- G726
- SPEEX
- ADPCM
- MPEG4

VoIP Setting

Setting	Description
DTMF Mode	<p>Set the default mode for sending DTMF tones.</p> <ul style="list-style-type: none"> • RFC4733 (RFC2833): DTMF will be carried in the RTP stream in different RTP packets rather than the audio signal. • Info: DTMF will be carried in the SIP info messages. • Inband: DTMF will be carried in the audio signal. • Auto: The PBX will detect if the device supports RFC4733(RFC2833) DTMF. If RFC4733(RFC2833) is supported, PBX will choose RFC4733(RFC2833), or the PBX will choose Inband.
Qualify	Enable this option to send SIP OPTION packet to SIP device to check if the device is up.
Enable SRTP	Enable or disable SRTP (encrypted RTP) for the trunk.
T.38 Support	<p>Enable or disable T.38 fax for this trunk. Enabling T.38 will add the performance cost.</p> <p>We suggest that you disable T.38.</p>
Inband Progress	<p>This Inband Progress setting applies to the extensions which make calls through this trunk.</p> <p> Note: To configure global Inband Progress setting, you need to contact Yeastar support to configure a custom config file.</p> <ul style="list-style-type: none"> • Check this option: PBX will send a 183 Session Progress to the extension when told to indicate ringing and will immediately start sending ringing as audio. • Uncheck this option: PBX will send a 180 Ringing to the extension when told to indicate ringing and will NOT send it as audio.

Call Restriction

Setting	Description
Call Restriction Type	<p>Specify based on which type of calls to restrict the max concurrent call number of this trunk.</p> <ul style="list-style-type: none"> • Outbound Call: Only outbound calls will be restricted.

Setting	Description
	<ul style="list-style-type: none"> • All: Both outbound calls and inbound calls will be restricted.
Maximum Concurrent Calls	Specify the maximum number of concurrent calls allowed in this trunk. The default is Unlimited.

DIDs/DDIs

Direct Inward Dialling (DID), also called Direct Dial-in (DDI), is a service offered by telephone companies. For more information of DID concepts, see [DID Number Overview](#).

- DID numbers are usually configured on inbound routes to distinguish inbound calls. For more information, see [Route Inbound Calls based on DID Numbers](#).
- When you need to configure DID numbers on a trunk and how to configure the DID numbers, see [Configure DID Numbers on a Trunk](#).

Inbound Caller ID Reformatting

When a user calls in the PBX, the trunk provider may send an caller ID that is inconvenient for you to redial directly.

In this case, you can reformat inbound caller ID based on a trunk. The caller ID will be reformatted before it is sent to the called party.

For more information, see [Reformat Inbound Caller ID based on a Trunk](#).

Outbound Caller ID

Outbound caller ID is the phone number or name that is displayed on the called party's device.

You can set up a global outbound caller ID for a trunk or assign caller IDs for extension users.

 **Note:** By default, each trunk has a default phone number that will be displayed on the called party's device. Outbound Caller ID configuration requires support from the trunk provider. Contact your trunk provider first before you configure Outbound Caller ID, or the settings won't take effect and outbound calls may fail.

If you set the caller ID number, when users make outbound calls through this trunk, the called party will see this caller ID number instead of the calling party's number.

For more information of outbound caller ID configurations, see [Customize Outbound Caller IDs](#)

SIP Headers

The SIP Headers settings require professional knowledge of SIP protocol. Incorrect configurations may cause calling issues. It is wise to leave the default settings provided on the SIP trunk page. However, for a few fields, you need to change them to suit your situation.

The following settings are included on the **SIP Headers** page.

- [Inbound Parameters](#)
- [Outbound Parameters](#)
- [Other Settings](#)

Inbound Parameters

Setting	Description
Get Caller ID From	<p>Decide from which header field will the trunk retrieve Caller ID.</p> <ul style="list-style-type: none"> • [Follow System] The trunk will follow the global Get Caller ID From setting. • From • Contact • Remote-Party-ID • P-Asserted Identify • P-Preferred-Identity
Get DID From	<p>Different devices or providers may contain DID numbers in different SIP headers. When an inbound call through a SIP trunk reaches the PBX, the PBX needs to retrieve a correct DID number, or the call will fail.</p> <p>Adjust the setting after analysis of the SIP packets sent from the trunk provider. The following SIP headers are available to select:</p> <ul style="list-style-type: none"> • [Follow System] The trunk will follow the global Get DID From setting. • To • Invite • Diversion • Remote-Party-ID <p> Note: If this option is selected, but the SIP provider doesn't support Remote Party ID, the PBX will retrieve DID from INVITE header.</p> <ul style="list-style-type: none"> • P-Asserted Identify • P-Called-Party-ID • P-Preferred-Identity

Outbound Parameters

For outbound calls, you can define the parameters included in the following SIP INVITE headers:

- **From**

A From header contains caller ID and caller ID name, which are defined as the followings in Yeastar P-Series PBX System.

From User Part: Indicates caller ID.

From Display Name Part: indicates caller ID name.

You can define which parameters will be used in these two parts of a SIP From header.

- **Diversion**
- **Remote Party ID**
- **P-Asserted Identify**
- **P-Preferred-Identity**

Each SIP header has multiple options to define the parameters. The following tables describe the options.

 **Note:** For different types of SIP trunk, the optional items are different.

Setting	Description
[Default]	The system selects a parameter by the following priority from top to bottom: <ul style="list-style-type: none"> • Outbound Route Outbound Caller ID • Extension's Outbound Caller ID in Trunk • Trunk Outbound Caller ID • Trunk Username • Extension Caller ID • The Originator Caller ID
[None]	Do not send the parameter with the SIP INVITE packet.
Outbound Route Outbound Caller ID	The outbound caller ID configured on the outbound route that is used for the outbound calls.
Extension's Outbound Caller ID in Trunk	The extension's associated outbound caller ID with the trunk.
Trunk Outbound Caller ID	The global outbound caller ID for the trunk (Trunk > Outbound Caller ID > General).
Trunk Username	The username configured on the trunk.
Extension Caller ID	The caller ID configured on the extension.
The Originator Caller ID	The Caller ID of the call originator (the first caller in the case that the call is transferred). <ul style="list-style-type: none"> • If the call originator is an external number, the external number will be taken.

Setting	Description
	<ul style="list-style-type: none"> If the call originator is an extension, the priority order will be Extension Outbound Caller ID # [Default].
Custom	Define a custom value.

Other Settings

Setting	Description
User Agent	If the ITSP requires User Agent for authentication, enter the User Agent information that is provided by the ITSP.
Send Privacy ID	Whether to send the Privacy ID in SIP header or not. The default is unchecked.
User Phone	Whether to add the parameter <code>user=phone</code> as a request line in the header field of the SIP INVITE packet.  Note: Enable this option only when the SIP provider requires.
100rel	Whether to support 100rel or not.
Maxptime	Select the value of the Maxptime used when the PBX sends the INVITE packet.
Support P-Early-Media	Set whether the P-Early-Media field is included in the INVITE packet.

Analog FXO Trunk

Analog FXO Trunk Overview

This topic describes what is analog FXO trunk and usages of analog FXO trunk.

What is analog FXO trunk

An analog FXO trunk is a telephone line that connects your PBX and the Public Switched Telephone Network (PSTN) or a traditional PBX.

- **Connect FXO port of Yeastar P-Series PBX System and a PSTN provider**
Extension users can make and receive calls with the external users through the trunk
- **Connect FXO port of Yeastar P-Series PBX System and FXS port of a traditional PBX**

A company can integrate their legacy PBX with Yeastar P-Series PBX System to utilize the benefit of VoIP easily and achieve cost-effective communication.

Set up an Analog FXO Trunk

This topic describes how to set up an analog FXO trunk on Yeastar P-Series PBX System.

Prerequisites

- Install at least one O2 module or SO module on the PBX.
 - # If the module is successfully installed and detected by the PBX, the FXO port information will be displayed on the PBX web interface.
 - # If the module is not detected by the PBX, contact Yeastar support to check the problem.

Procedure

1. Find out the FXO port on the PBX.

Log in to the PBX web interface, go to **Extension and Trunk > Trunk**, check the location of the FXO port.

As the following figure shows, an FXO port is located in Span2-Port2.

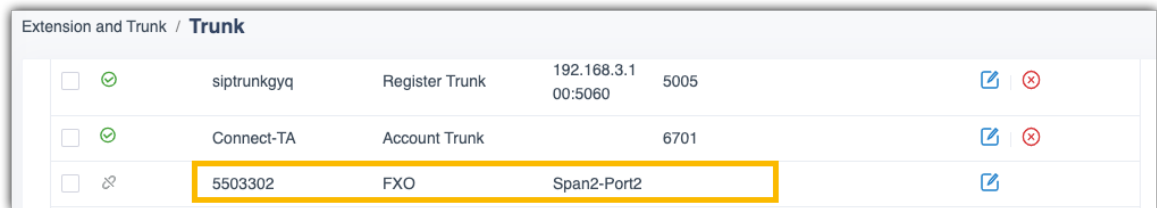

Extension and Trunk / Trunk						
<input type="checkbox"/>	✔	siptrunkgyq	Register Trunk	192.168.3.1 00:5060	5005	✎ ✖
<input type="checkbox"/>	✔	Connect-TA	Account Trunk		6701	✎ ✖
<input type="checkbox"/>	⚠	5503302	FXO	Span2-Port2		✎

2. Use a RJ11 phone line to connect the FXO port of PBX and the PSTN provider's FXS port.

In this example, connect the phone line to port 2 on span 2.

3. **Optional:** Configure the FXO trunk settings.

Go to **Extension and Trunk > Trunk**, select the FXO trunk to edit the trunk settings.

Note: The advanced settings require professional knowledge of analog telephony, carefully configure the advanced settings, or the trunk would not work.

For more information of FXO trunk settings, see [Analog FXO Trunk Settings](#).

Result

Go to **Extension and Trunk > Trunk** to check the trunk status on the trunk list page.

If the status shows , the trunk is connected successfully.

See [FXO Trunk status](#) to know more information of FXO trunk status.

What to do next

- To receive inbound calls through the trunk, you need to select this trunk to one or more inbound routes. For more information, see [Set up an Inbound Route](#).
- To make outbound calls through the trunk, you need to select this trunk to one or more outbound routes. For more information, see [Set up an Outbound Route](#).

Release an Analog FXO Trunk

If an FXO trunk keeps in Busy status after a call is hung up, you can mandatory release the trunk to make the trunk available to use.

Background information

The issue that the trunk cannot be released automatically after a call is hung up is usually caused by incorrect Hangup Detection settings.

Procedure

1. Log in to the PBX web interface, go to **Extension and Trunk > Trunk**, edit the problematic FXO trunk.
2. Click **Advanced** tab.
3. On the **Advanced** page, click **Release Trunk**.

The trunk will be released, and the trunk status shows .

What to do next

Adjust the [Hangup Detection settings](#) for the problematic FXO trunk.

 **Note:** The Hangup Detection settings require good knowledge of analog telephony, you may need to contact the trunk provider or Yeastar Support to configure the settings.

Analog FXO Trunk Settings

This topic describes all the settings on an FXO trunk for reference.

Basic settings

Setting	Description
Name	Give this trunk a name to help you identify it.
RX Volume	Set the receiving volume of the FXO port.

Setting	Description
TX Volume	Set the transmitting volume of the FXO port.

Advanced settings



The advanced settings require professional knowledge of analog telephony, carefully configure the advanced settings, or the trunk would not work. For different PSTN providers, you may need to adjust the advanced settings to suit your situation.

The following settings are included on the **Advanced** page.

- [Hangup Detection](#)
- [Answer Detection](#)
- [Caller ID Settings](#)
- [Other Settings](#)

Hangup Detection

Hangup Detection settings help the PBX to detect if a call is hung up. If you find outbound calls through the FXO trunk cannot be disconnected, adjust the Hangup Detection settings.

Setting	Description
Hangup Detection Method	<p>Select the Hangup Detection method:</p> <ul style="list-style-type: none"> • Busy Tone: The call will be disconnected if a busy tone is detected by the Yeastar P-Series PBX System. • Polarity Reversal: The call will be disconnected if a polarity reversal is detected by the Yeastar P-Series PBX System. • Loop Current Disconnect: When the remote side of FXO trunk disconnects the call and creates a loop current, Yeastar P-Series PBX System will detect the loop current and disconnect the call.
Busy Count	<p>Specify how many busy tones to wait for before disconnecting. The default value is 4.</p> <p> Note: PBX may fail to detect the busy tone if the value of Busy Count is too high.</p>
Busy Pattern	<p>Specify the cadence of busy signal.</p> <ul style="list-style-type: none"> • Format: <i>{sound},{silence}</i>. <p>For example, 500,500 means 500ms on, 500ms off.</p> <p> Note:</p>

Setting	Description
	<ul style="list-style-type: none"> • If you select [None], the system will accept any regular sound-silence pattern that repeats Busy Count times as a busy signal. • If you select a busy tone, the system will further check the length of the tone and silence, which will further reduce the chance of a false positive disconnection.
Busy Interval (s)	The busy detection interval.
Frequency Detection	Enable or disable detection of busy signal frequency.
Busy Frequency	If the Frequency Detection is enabled, you need to specify the local frequency.

Answer Detection

Setting	Description
Answer Detection Method	<p>Specify the method to detect if a call is answered. This setting affects the accuracy of call duration tracking.</p> <ul style="list-style-type: none"> • [None]: PBX will start counting call duration after you use the FXO trunk to call out, whether the call is answered or not. • Polarity Reversal: If this option is selected, PBX will start counting call duration after a polarity signal is detected. <p> Note: Before you select this option, contact the PSTN provider to check if they supports polarity.</p>

Caller ID Settings

Caller ID Settings helps the system to detect Caller ID. If an incoming PSTN call does not display Caller ID, you need to confirm with your service provider if the line has enabled Caller ID feature. If this line does support Caller ID, configure these settings to solve this problem.

Setting	Description
Caller ID Detection	Enable or disable Caller ID detection.
Caller ID Detection Mode	<p>Define the start of a Caller ID signal.</p> <ul style="list-style-type: none"> • After Ringing: Detect Caller ID after first ringing. • After Polarity: Detect Caller ID after polarity reversal. • Before Ringing: Detect Caller ID before first ringing.
Caller ID Signaling	Specify the type of caller ID signaling to use according to the direction provided by your service provider.

Setting	Description
	<ul style="list-style-type: none"> • Bell202 • V23-Japan • DTMF • ETSI-V23

Other Settings

Setting	Description
Ringing Detection Timeout (ms)	<p>FXO (FXS signalled) devices must have a timeout to determine if there was a hangup before the line was answered.</p> <ul style="list-style-type: none"> • Valid value: 1000-10000 • Default value: 5000
Echo Cancellation	Enable or disable echo cancellation.
DID Name	DID Name is used to identify which telephone number was dialed. When an inbound call reaches the trunk, the name will be displayed on the called party's device.
Inbound to Outbound Number	<p>This setting is typically for Inbound Route to Outbound Route feature.</p> <p>If you wish the inbound call through this trunk to be redirected via an outbound route, enter the destination number in this field.</p>

Inbound Caller ID Reformatting

When a user calls in the PBX, the trunk provider may send an caller ID that is inconvenient for you to redial directly.

In this case, you can reformat inbound caller ID based on a trunk. The caller ID will be reformatted before it is sent to the called party.

For more information, see [Reformat Inbound Caller ID based on a Trunk](#).

GSM/3G/4G LTE Trunk

GSM/3G/4G LTE Trunk Overview

This topic describes what is GSM/3G/4G LTE trunk and frequency bands supported on Yeastar P-Series PBX System.

What is GSM/3G/4G LTE trunk

A GSM/3G/4G LTE trunk connects the Yeastar P-Series PBX System and the relevant cellular network provider directly, and capitalizes on the cheaper mobile-to-mobile call tariffs.

To use a GSM/3G/4G LTE trunk, you need to install a relevant module on the PBX and insert a SIM card that can work in the supported frequency bands.

GSM/3G/4G LTE Module frequency bands

Module Type	Module Model	Frequency Band
GSM	SIM800	<ul style="list-style-type: none"> • EGSM-900 MHz • PGSM-900 MHz • DCS-1800 MHz • GSM850-850 MHz • PCS-1900 MHz
3G	UC15-A	<ul style="list-style-type: none"> • WCDMA: 850/1900 MHz • GSM: 850/900/1800/1900 MHz
3G	UC15-E	<ul style="list-style-type: none"> • WCDMA: 900/2100 MHz • GSM: 900/1800 MHz
3G	UC15-T	<ul style="list-style-type: none"> • WCDMA: 850/2100 MHz • GSM: 850/900/1800/1900 MHz
4G LTE	EC20-CEFAG	<ul style="list-style-type: none"> • FDD-LTE: B1/B3/B8/B5 • TDD-LTE: B38/B39/B40/B41 • WCDMA: B1/B8 • TD-SCDMA: B34/B39 • CDMA2000 1X: BC0 • CDMA2000 EVDO: BC0 • GSM: 900/1800 MHz
4G LTE	EC20-CEFD	<ul style="list-style-type: none"> • FDD-LTE: B1/B3/B8 • TDD-LTE: B38/B39/B40/B41 • WCDMA: B1/B8 • TD-SCDMA: B34/B39 • CDMA2000 1X: BC0 • CDMA2000 EVDO: BC0 • GSM: 900/1800 MHz
4G LTE	EC25-A	<ul style="list-style-type: none"> • FDD-LTE: B2/B4/B12 • WCDMA: B2/B4/B5
4G LTE	EC25-AU	<ul style="list-style-type: none"> • FDD-LTE: B1/B2/B3/B4/B5/B7/B8/B28 • TDD-LTE: B40 • WCDMA: B1/B2/B5/B8 • GSM: B2/B3/B5/B8
4G LTE	EC25-E	<ul style="list-style-type: none"> • FDD-LTE: B1/B3/B5/B7/B8/B20 • TDD-LTE: B38/B40/B41 • WCDMA: B1/B5/B8 • GSM: B3/B8

Module Type	Module Model	Frequency Band
4G LTE	EC25-J	<ul style="list-style-type: none"> • FDD-LTE: B1/B3/B8/B18/B19/B26 • TDD-LTE: B41 • WCDMA: B1/B6/B8/19
4G LTE	EC25-V	<ul style="list-style-type: none"> • FDD-LTE: B4/B13

Set up a GSM/3G/4G LTE Trunk

This topic describes how to set up a GSM/3G/4G LTE trunk on Yeastar P-Series PBX System.

Prerequisites

- Install at least one GSM module, 3G module, or 4G LTE module on the PBX.
 - # If the module is successfully installed and detected by the PBX, the trunk will be displayed on the PBX web interface.
 - # If the module is not detected by the PBX, contact Yeastar support to check the problem.

Procedure

1. Install a SIM card on the GSM/3G/4G LTE module.

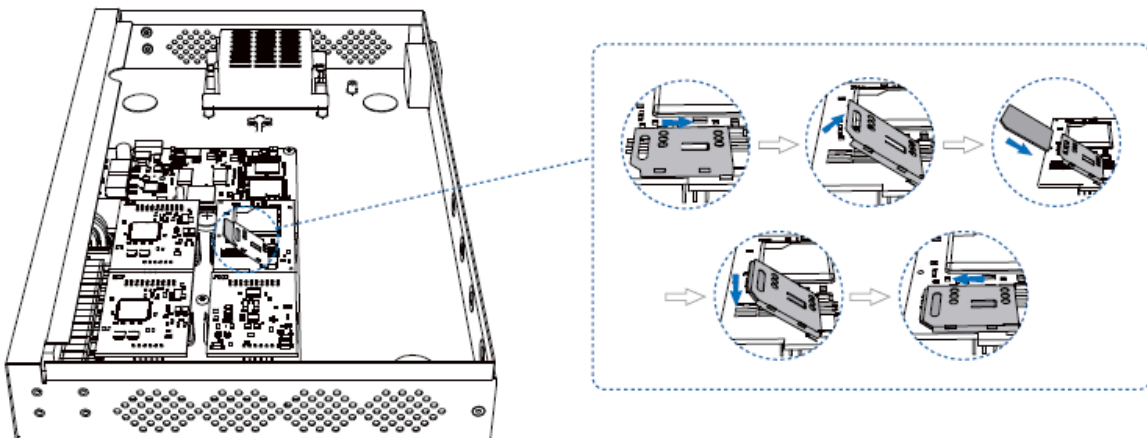

2. Rotate the antenna into the Antenna Socket.

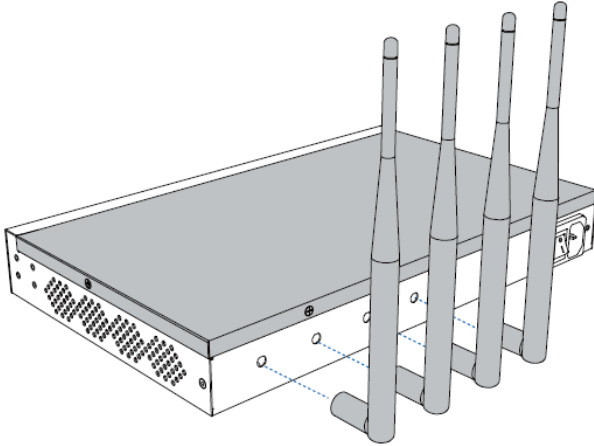



3. Optional: Configure the GSM/3G/4G LTE trunk settings.

Log in to the PBX Go to **Extension and Trunk > Trunk**, select the GSM/3G/4G LTE trunk to edit the trunk settings.

For more information of GSM/3G/4G LTE trunk settings, see [GSM/3G/4G LTE Trunk Settings](#).

Result

Go to **Extension and Trunk > Trunk** to check the trunk status on the trunk list page.

If the status shows , , or , the trunk is successfully set up, and the icon also indicates the signal strength of the trunk.

For more information of GSM/3G/4G LTE trunk status, see [GSM/3G/4G LTE Trunk Settings](#).

What to do next

- To receive inbound calls through the trunk, you need to select this trunk to one or more inbound routes. For more information, see [Set up an Inbound Route](#).
- To make outbound calls through the trunk, you need to select this trunk to one or more outbound routes. For more information, see [Set up an Outbound Route](#).

GSM/3G/4G LTE Trunk Settings

This topic describes all the settings on an GSM/3G/4G LTE trunk for reference.

Basic settings

General	
Setting	Description
Name	Give this trunk a name to help you identify it.
PIN Code	Enter the SIM card PIN code if the card has one.  Note: If you fail to enter your correct PIN code for 3 times in succession, the SIM card will be permanently locked, which means you will need a new SIM card.
RX Volume	Set the receiving volume of GSM/3G/4G LTE port or select Custom to define the RX Gain.
TX Volume	Set the transmitting volume of GSM/3G/4G LTE port or select Custom to define the TX Gain.
Echo Cancellation	Enable or disable echo cancellation.
DID Name	DID Name is used to identify which telephone number was dialed. When an inbound call reaches the trunk, the name will be displayed on the called party's device.
Inbound to Outbound Number	This setting is typically for Inbound Route to Outbound Route feature. If you wish the inbound call through this trunk to be redirected via an outbound route, enter the destination number in this field.

Carrier Settings	
Setting	Description
Carrier	Select the carrier mode.  Note: When the trunk is in unregistered status, you can try to manually select the correct carrier to fix the issue. <ul style="list-style-type: none">• Automatic: The system will detect the SIM card and select a carrier automatically.• Manual: Select a carrier from the available carrier that the system provided.

Inbound Caller ID Reformatting

When a user calls in the PBX, the trunk provider may send an caller ID that is inconvenient for you to redial directly.

In this case, you can reformat inbound caller ID based on a trunk. The caller ID will be reformatted before it is sent to the called party.

For more information, see [Reformat Inbound Caller ID based on a Trunk](#).

ISDN E1/T1 Trunk

E1/T1/J1 Trunk Overview

This topic describes what is E1/T1/J1 trunk and the differences among the three types of trunk. This topic also provides the information of E1/T1/J1 crossover cable.

What is E1/T1/J1 trunk

E1/T1/J1 is known as Primary Rate Interface (PRI), an Integrated Services Digital Network (ISDN) access method, which enables traditional phone lines to carry voice, data, and video traffic.

Note:

- E1/T1/J1 trunk is only supported on Yeastar P560 and P570.
- To extend E1/T1/J1 trunk, you need to install EX30 expansion board on the PBX. One EX30 expansion board provides an E1/T1/J1 port.

Differences between E1, T1, and J1

The PRI consists of B channels at 64 kbit/s each and D channel at 64 kbit/s each. The B channels are used for voice or user data, and the D channel is used for any combination of data, control/signalling, and X.25 packet networking.

According to the number of B-channels and D-channels, there are three types of PRI interface: E1, T1 and J1.

PRI Type	Description
E1	Contains 30 B-channel and 2 D-channel and is used in Europe, China, and most of the Asia countries.
T1	Contains 23 B-channel and one D-channel and is used in the USA, Canada, and Hong Kong.
J1	It is almost the same as T1 but used in Japan with some slight modifications, this is the Japanese standard for PRI.

E1/T1/J1 crossover cable

You can get an E1/T1/J1 crossover cable from the carrier or make a crossover cable yourself.

 **Note:** E1/T1/J1 crossover cable is different from the Ethernet cable, but you can make a crossover cable by an Ethernet cable.

The pinouts of an E1/T1/J1 crossover cable is shown as the following figure.

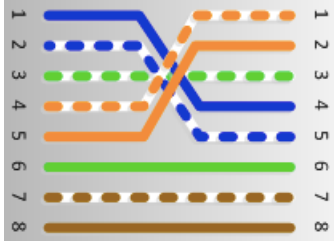

Set up an E1/T1/J1 Trunk

This topic describes how to set up an E1/T1/J1 trunk on Yeastar P-Series PBX System.

Background information

ISDN uses circuit-switching to establish a physical permanent point-to-point connection from the source to the destination. ISDN has standards defined by the ITU that encompass the OSI bottom three layers of which are Physical, Data Link, and Network.

To set up an E1/T1/J1 trunk, you need to make sure both the Physical layer and the Data Link layer run properly.



Prerequisites

- E1/T1/J1 trunk is only supported on Yeastar P560 and P570.
- Install at least one EX30 expansion board on the PBX.
- Prepare an [E1/T1/J1 crossover cable](#).
- Gather signalling information of the E1/T1/J1 trunk from the ISDN carrier, such as the following information.
 - # Carrier type
 - # Signalling type
 - # Line coding Mechanism
 - # Framing Mode
 - # D-Channel
 - # B-Channel

Procedure

1. Connect one end of E1/T1/J1 cable to the E1/T1/J1 port on the PBX, and connect the other end of the cable to the ISDN provider's equipment.
2. Check if the trunk is successfully connected to the PBX on the Physical layer.

Log in to the PBX web interface, go to **Extension and Trunk > Trunk** to check the E1/T1/J1 trunk status.

- If the trunk status shows  or , the physical layer of this trunk is correct.

- If the trunk status shows , the physical layer of this trunk is incorrect, check the cable or contact Yeastar support to solve it.
3. Configure the E1/T1/J1 trunk settings to make the Data Link layer up.
 - a. Go to **Extension and Trunk > Trunk**, edit the desired E1/T1/J1 trunk.
 - b. On the **Basic** page, configure the required settings according to the parameters that are provided by the ISDN carrier.
 - c. **Optional:** Configure other settings of the E1/T1/J1 trunk according to the carrier's requirements.

For more information of the E1/T1/J1 trunk information, see [E1/T1/J1 Trunk Settings](#).
 - d. Click **Save**.
 - e. Reboot the system to take effect.

Result

Go to **Extension and Trunk > Trunk** to check the trunk status on the trunk list page.

If the status shows , the trunk is ready for use.

For more information of E1/T1/J1 trunk status, see [E1/T1/J1 Trunk status](#).

What to do next

- To receive inbound calls through the trunk, you need to select this trunk to one or more inbound routes. For more information, see [Set up an Inbound Route](#).
- To make outbound calls through the trunk, you need to select this trunk to one or more outbound routes. For more information, see [Set up an Outbound Route](#).

E1/T1/J1 Trunk Settings

This topic describes all the settings on an E1/T1/J1 trunk for reference.



E1/T1/J1 signaling type



Yeastar P560 and P570 support the following ISDN signaling type, you can configure the trunk according to the information provided by the ISDN carrier.

- [PRI](#)
- [MFC/R2](#)
- [SS7](#)
- [E&M](#)

PRI settings

The table below shows the **Basic** settings and **Advanced** settings for the E1/T1/J1 trunk (PRI signaling type).

Setting	Description
Basic Settings	
Name	Give this trunk a name to help you identify it.
Interface Type	<p>Specify the interface type according to the trunk specification.</p> <ul style="list-style-type: none"> • E1 • T1 • J1
Signaling	Specify the Signaling type PRI .
Framing	<p>Select the frame format for this trunk according to the requirements of your country and carrier. The frame format of the PBX must be the same as that of the carrier. Otherwise, the link cannot be established.</p> <ul style="list-style-type: none"> • When the Interface Type is E1, Framing options are: <ul style="list-style-type: none"> # Enable CRC4 # Disable CRC4 <p> Note: CRC4 is a method of checking for errors in data transmitted on E1 trunk lines.</p> <ul style="list-style-type: none"> • When the Interface Type is T1 or J1, Framing options are: <ul style="list-style-type: none"> # ESF # D4
Line Code	<p>Choose the line code for this trunk according to the direction provided by carrier.</p> <ul style="list-style-type: none"> • When the Interface Type is E1, Line Code options are: <ul style="list-style-type: none"> # HDB3 # AMI • When the Interface Type is T1 or J1, Line Code options are: <ul style="list-style-type: none"> # B8ZS # AMI
Codec	<p>Choose the codec for this trunk.</p> <ul style="list-style-type: none"> • a-law • u-law
Echo Cancellation	<p>This option enables or disables echo cancellation.</p> <p> Note: If an echo occurs during a call, you can enable echo cancellation.</p>
D Channel	<p>Set the channel used to carry control information and signaling information.</p> <ul style="list-style-type: none"> • If Interface Type is set to E1, enter a channel number from 1 to 31. • If Interface Type is set to T1 or J1, enter a channel number from 1 to 24.



Setting	Description
Basic Settings	
Switch Type	<p>Configure the switch type according to the direction provided by carrier.</p> <ul style="list-style-type: none"> • If Interface Type is set to E1, Switch Type option are: <ul style="list-style-type: none"> # EuroISDN # Q.SIG • If Interface Type is set to T1 or J1, Switch Type option are: <ul style="list-style-type: none"> # EuroISDN # National 2 # National 1 # DMS100 # AT&T 4ess # Lucent 5ess # Q.SIG
Signaling Role	<p>Specify whether this interface will act as the user or the network.</p> <ul style="list-style-type: none"> • User: If the service provider acts as the network, the PBX needs to be set as the User. • Network: If the service provider acts as the user, the PBX needs to be set as the Network.
Overlap Dial	<p>Define whether the system can dial this switch using overlap digits or not. If you need Direct Dial-in, then enable this option.</p>
Advanced Settings	
Facility-based ISDN Supplementary Services	<p>Decide whether to enable transmission of facility-based ISDN supplementary services (such as caller name from CPE over facility) or not.</p>
PRI Indication	<p>Select the PRI Indication.</p> <ul style="list-style-type: none"> • Out-of-Band: Use RELEASE, DISCONNECT or other messages with CAUSE to indicate call progress (e.g., cause: unassigned number or user busy). • Inband: Use in-band tones to play busy or congestion signal to the other side. <p> Note: Inband notification is not available on all PRI/BRI subscription lines.</p>
Reset Interval (s)	<p>This sets the time in seconds between restart of unused B channels. The default is "Never".</p> <p> Note: Set the interval to "Never" if you do not wish the channel to restart.</p>
Carrier Hangup Tone Detection	<ul style="list-style-type: none"> • If this option is enabled, you will hear the hangup tone played by your carrier when the other party hangs up. (Please first check with your carrier whether they will send the prompt or not.) • If disabled, you will hear the hangup tone played by the system when the other party hangs up.

Setting	Description
Basic Settings	
Dialplan	
Calling Party Numbering Plan	Select the Calling Party Numbering Plan.
Calling Party Numbering Type	Select the Calling Party Numbering Type.
Called Party Numbering Plan	Select the Calling Party Numbering Plan.
Called Party Numbering Type	Select the Called Party Numbering Type.
Presentation Indicator	The PI provides instructions on whether the provided calling line identity is allowed to be presented, or indicates that the number is not available.
Screen Indicator	The SI provides information on the source and the quality of the provided information.
ISDN Dialplan	Enable or disable the ISDN/telephony numbering plan (Recommendation E.164)
International Prefix	Dialplan: '(Calling Party Numbering Plan:ISDN +)Calling Party Numbering Type:International'
National Prefix	Dialplan: '(Calling Party Numbering Plan:ISDN +)Calling Party Numbering Type:National'
Local Prefix	Dialplan: '(Calling Party Numbering Plan:ISDN +)Calling Party Numbering Type:Subscriber'
Private Prefix	Dialplan: 'Calling Party Numbering Plan:private + Calling Party Numbering Type:Subscriber'
Unknown Prefix	Dialplan: '(Calling Party Numbering Plan:ISDN +)Calling Party Numbering Type:Unknown'

MFC/R2 settings

The table below shows the **Basic** settings and **Advanced** settings for the E1/T1/J1 trunk (MFC/R2 signaling type).

Setting	Description
Basic Settings	
Name	Give this trunk a name to help you identify it.
Signaling	Specify the Signaling type MFC/R2 .
Framing	Select the frame format for this trunk according to the requirements of your country and carrier. The frame format of the PBX must be the same as that of the carrier. Otherwise, the link cannot be established.



Setting	Description
Basic Settings	
	<p>Framing options are:</p> <ul style="list-style-type: none"> • Enable CRC4 • Disable CRC4 <p> Note: CRC4 is a method of checking for errors in data transmitted on E1 trunk lines.</p>
Line Code	<p>Choose the line code for this trunk according to the direction provided by carrier.</p> <p>Line Code options are:</p> <ul style="list-style-type: none"> • HDB3 • AMI
Echo Cancellation	<p>This option enables or disables echo cancellation.</p> <p> Note: If an echo occurs during a call, you can enable echo cancellation.</p>
Variant	<p>Set the MFC/R2 variant.</p> <ul style="list-style-type: none"> • Argentina • Brazil • China • Czech • Colombia • Ecuador • Indonesia • ITU • Mexico • Philippines • Venezuela
Category	<p>Set the category of the calling party.</p> <ul style="list-style-type: none"> • National • National priority • International • International Priority • Collect Call
MAX DNIS	<p>Maximum amount of DNIS to ask for.</p> <p> Note: If you wish to customize the size, enter the value in the text box directly.</p>
MAX ANI	<p>Maximum amount of ANI to ask for.</p>
Advanced Settings	
Forced Release	<p>Enable or disable forced release of channel.</p>

Setting	Description
Basic Settings	
	 Note: If the call can not be hung up properly, check this option.
Immediate Accept	Most variants of MFC/R2 offer a way to go directly to the call accepted state, by passing the use of group B and II tones. This option enables or disables the use of that feature for incoming calls. The default is unchecked.
Double Answer	Block collect calls with double answer. This will cause that every answer signal is changed by answer -> clear back -> answer. The default is unchecked.
Charge Calls	Whether or not report to the other end "accept call with charge".
Allow Collect Calls	Specify whether to accept collect calls or not.
MF Back Timeout (ms)	MFC/R2 value in milliseconds for the MF timeout.
Metering Pulse Timeout (ms)	MFC/R2 value in milliseconds for the metering pulse timeout. Enter "-1" to use the value.
Incoming DTMF Mode	Specify the incoming DTMF mode.
Outgoing DTMF Mode	Specify the outgoing DTMF mode.

SS7 settings



The table below shows the **Basic** settings and **Advanced** settings for the E1/T1 trunk (SS7 signaling type).

Setting	Description
Basic Settings	
Name	Give this trunk a name to help you identify it.
Signaling	Specify the Signaling type SS7 .
Framing	<p>Select the frame format for this trunk according to the requirements of your country and carrier. The frame format of the PBX must be the same as that of the carrier. Otherwise, the link cannot be established.</p> <p>Framing options are:</p> <ul style="list-style-type: none"> • Enable CRC4 • Disable CRC4 <p> Note: CRC4 is a method of checking for errors in data transmitted on E1 trunk lines.</p>
Line Code	<p>Choose the line code for this trunk according to the direction provided by your carrier.</p> <p>Line Code options are:</p> <ul style="list-style-type: none"> • HDB3

Setting	Description
Basic Settings	
	<ul style="list-style-type: none"> • AMI
Codec	Choose the codec for this trunk.
Echo Cancellation	<p>This option enables or disables echo cancellation.</p> <p> Note: If an echo occurs during a call, you can enable echo cancellation.</p>
D Channel	Set the channel used to carry control information and signaling information. Enter a channel number from 1 to 31.
Variant	<p>Set the SS7 variant.</p> <ul style="list-style-type: none"> • ANSI: 24 bits • China: 24 bits • ITU: 14 bits
Linkset	Display SS7 linkset numbers.
Network indicator	Specify the network indicator according to the network environment.
SLC	Specify the Signal Linking Code.
OPC	Specify the Originating Point Code. This is generally assigned by your carrier.
DPC	Specify the Destination Point Code. This is generally assigned by your carrier.
Advanced Settings	
Start CIC No.	<p>Specify the Circuit Identification Code number of the first B channel of E1 line (SS7).</p> <p> Note: The suggested value is the multiples of 32 plus 1, for example: 1, 33, 65.</p>
Calling Party Number Type	<p>Specify the calling party number type.</p> <ul style="list-style-type: none"> • National • International • Subscriber • Unknown
Called Party Number Type	<p>Specify the calling party number type.</p> <ul style="list-style-type: none"> • National • International • Subscriber • Unknown

E&M settings

The table below shows the **Basic** settings and **Advanced** settings for the E1/T1/J1 trunk (E&M signaling type).

Setting	Description
Name	Give this trunk a name to help you identify it.
Interface Type	Specify the interface type according to the trunk specification. <ul style="list-style-type: none"> • E1 • T1 • J1
Signaling	Specify the Signaling type E&M .
Framing	Select the frame format for this trunk according to the requirements of your country and carrier. The frame format of the PBX must be the same as that of the carrier. Otherwise, the link cannot be established. <ul style="list-style-type: none"> • When the Interface Type is E1, Framing options are: <ul style="list-style-type: none"> # Enable CRC4 # Disable CRC4 <p> Note: CRC4 is a method of checking for errors in data transmitted on E1 trunk lines.</p> • When the Interface Type is T1 or J1, Framing options are: <ul style="list-style-type: none"> # ESF # D4
Line Code	Choose the line code for this trunk according to the direction provided by your carrier. Line Code options are: <ul style="list-style-type: none"> • HDB3 • AMI
Codec	Choose the codec for this trunk.
Echo Cancellation	This option enables or disables echo cancellation. <p> Note: If an echo occurs during a call, you can enable echo cancellation.</p>

DIDs/DDIs

Direct Inward Dialling (DID), also called Direct Dial-in (DDI), is a service offered by telephone companies. For more information of DID concepts, see [DID Number Overview](#).

- DID numbers are usually configured on inbound routes to distinguish inbound calls. For more information, see [Route Inbound Calls based on DID Numbers](#).

- When you need to configure DID numbers on a trunk and how to configure the DID numbers, see [Configure DID Numbers on a Trunk](#).

Inbound Caller ID Reformatting

When a user calls in the PBX, the trunk provider may send an caller ID that is inconvenient for you to redial directly.

In this case, you can reformat inbound caller ID based on a trunk. The caller ID will be reformatted before it is sent to the called party.

For more information, see [Reformat Inbound Caller ID based on a Trunk](#).

Outbound Caller ID

Outbound caller ID is the phone number or name that is displayed on the called party's device.

You can set up a global outbound caller ID for a trunk or assign caller IDs for extension users.

 **Note:** By default, each trunk has a default phone number that will be displayed on the called party's device. Outbound Caller ID configuration requires support from the trunk provider. Contact your trunk provider first before you configure Outbound Caller ID, or the settings won't take effect and outbound calls may fail.

If you set the caller ID number, when users make outbound calls through this trunk, the called party will see this caller ID number instead of the calling party's number.

For more information of outbound caller ID configurations, see [Customize Outbound Caller IDs](#)

ISDN BRI Trunk

BRI Trunk Overview

This topic describes what is BRI trunk and provides the information of BRI cable.

What is BRI trunk

Basic Rate Interface (BRI) is an Integrated Services Digital Network (ISDN) access method, typically used for home and small offices.

The BRI configuration provides 2 bearer channels (B channels) at 64 kbit/s each and 1 data channel (D channel) at 16 kbit/s. The B channels are used for voice or user data, and the D channel is used for any combination of data, control/signalling, and X.25 packet networking.

BRI cable

Yeastar P-Series PBX System supports for connecting an RJ11 4 pin cable or an RJ12 6 pin cable to a BRI port.

RJ11 4 pin connector



RJ12 6 pin connector

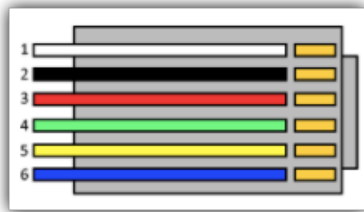

Set up a BRI Trunk

This topic describes how to set up a BRI trunk on Yeastar P-Series PBX System.

Prerequisites

- Install at least one B2 module on the PBX.
- Prepare a [BRI cable](#).
- Gather signalling information of the BRI trunk from the ISDN carrier, such as the following information.
 - # Signalling
 - # Switch Type
 - # Signalling Role

Background information



ISDN uses circuit-switching to establish a physical permanent point-to-point connection from the source to the destination. ISDN has standards defined by the ITU that encompasses the OSI bottom three layers of which are Physical, Data Link, and Network.

To set up a BRI trunk, you need to make sure both the Physical layer and the Date Link layer run properly.

Procedure

1. Connect one end of BRI cable to the BRI port on the PBX, and connect the other end of the cable to the ISDN provider's equipment.
2. Check if the trunk is successfully connected to the PBX on the Physical layer.

Log in to the PBX web interface, go to **Extension and Trunk > Trunk** to check the BRI trunk status.

- If the trunk status shows  or , the physical layer of this trunk is correct.
 - If the trunk status shows , the physical layer of this trunk is incorrect, check the cable or contact Yeastar support to solve it.
3. Configure the BRI trunk settings to make the Data Link layer up.
 - a. Go to **Extension and Trunk > Trunk**, edit the desired BRI trunk.
 - b. On the **Basic** page, configure the required settings according to the parameters that are provided by the ISDN carrier.
 - c. **Optional:** Configure other settings of the BRI trunk according to the carrier's requirements.

For more information of the BRI trunk information, see [BRI Trunk Settings](#).

 - d. Click **Save**.
 - e. Reboot the system to take effect.

Result

Go to **Extension and Trunk > Trunk** to check the trunk status on the trunk list page.

If the status shows , the trunk is ready for use.

For more information of BRI trunk status, see [BRI Trunk status](#).

What to do next

- To receive inbound calls through the trunk, you need to select this trunk to one or more inbound routes. For more information, see [Set up an Inbound Route](#).
- To make outbound calls through the trunk, you need to select this trunk to one or more outbound routes. For more information, see [Set up an Outbound Route](#).

BRI Trunk Settings

This topic describes all the settings on a BRI trunk for reference.

Basic settings

The following settings are required for a BRI trunk, which affect the connection status of the trunk.

Setting	Description
Name	Give this trunk a name to help you identify it.
Signaling	Specify the signaling type according to the direction provided by your service provider. <ul style="list-style-type: none"> • Peer to Peer • Peer to Multiple Peers
Signaling Role	Specify whether this interface will act as the user or the network. <ul style="list-style-type: none"> • User • Network <p> Note:</p> <ul style="list-style-type: none"> • If the service provider acts as the network, the PBX needs to be set as the user. • If the service provider acts as the user, the PBX needs to be set as the network.
Switch Type	Configure the switch type according to the direction provided by your service provider. <ul style="list-style-type: none"> • EuroISDN • National 2 • National 1 • DMS100 • AT&T 4ess • Lucent 5ess • Q.SIG

Advanced settings



Advanced settings affect inbound calls and outbound calls through the BRI trunk. Incorrect configuration may cause call failure.

The following settings are included on the **Advanced** page.

- [Advanced](#)
- [Dialplan](#)

Advanced

Setting	Description
Echo Cancellation	Enable or disable echo cancellation.
Facility-based ISDN Supplementary Services	Decide whether to enable transmission of facility-based ISDN supplementary services (such as caller name from CPE over facility) or not.

Setting	Description
Codec	Select the codec for this trunk.
Overlap Dial	Define whether the system can dial this switch using overlap digits or not. If you need Direct Dial-in, then enable this option.
Reset Interval	This sets the time in seconds between restart of unused B channels. Set the interval to Never if you don't like the channel to restart.
PRI Indication	Select the PRI Indication. <ul style="list-style-type: none"> • Out-of-Band: Use RELEASE, DISCONNECT or other messages with CAUSE to indicate call progress (e.g., cause: unassigned number or user busy). • Inband: Use in-band tones to play busy or congestion signal to the other side. <p> Note: Inband notification is not available on all PRI/BRI subscription lines.</p>
Carrier Hangup Tone Detection	<ul style="list-style-type: none"> • Check this option: You will hear the hangup tone played by your carrier when the other party hangs up. <p> Note: First check with your carrier whether they will send the prompt or not.</p> <ul style="list-style-type: none"> • Uncheck this option: You will hear the hangup tone played by the system when the other party hangs up.
Hide Outbound Caller ID	Whether to hide caller ID or not when calling out through this trunk.
Ignore Remote Hold Indications	If you wish to ignore remote hold indications and use PBX's Music on Hold, enable this option.

Dialplan

Setting	Description
Calling Party Numbering Plan	Select the Calling Party Numbering Plan.
Calling Party Numbering Type	Select the Calling Party Numbering Type.
Called Party Numbering Plan	Select the Called Party Numbering Plan.
Called Party Numbering Type	Select the Called Party Numbering Type.
Presentation Indicator	The PI provides instructions on whether the provided calling line identity is allowed to be presented, or indicates that the number is not available.

Setting	Description
Screen Indicator	The SI provides information on the source and the quality of the provided information.
ISDN Dialplan	ISDN/telephony numbering plan (Recommendation E.164)
International Prefix	Dialplan: '(Calling Party Numbering Plan:ISDN +)Calling Party Numbering Type:International'.
National Prefix	Dialplan: '(Calling Party Numbering Plan:ISDN +)Calling Party Numbering Type:National'.
Local Prefix	Dialplan: '(Calling Party Numbering Plan:ISDN +)Calling Party Numbering Type:Subscriber'.
Private Prefix	Dialplan: 'Calling Party Numbering Plan:private + Calling Party Numbering Type:Subscriber'.
Unknown Prefix	Dialplan: '(Calling Party Numbering Plan:ISDN +)Calling Party Numbering Type:Unknown'.

DIDs/DDIs

Direct Inward Dialling (DID), also called Direct Dial-in (DDI), is a service offered by telephone companies. For more information of DID concepts, see [DID Number Overview](#).

- DID numbers are usually configured on inbound routes to distinguish inbound calls. For more information, see [Route Inbound Calls based on DID Numbers](#).
- When you need to configure DID numbers on a trunk and how to configure the DID numbers, see [Configure DID Numbers on a Trunk](#).

Inbound Caller ID Reformatting

When a user calls in the PBX, the trunk provider may send an caller ID that is inconvenient for you to redial directly.

In this case, you can reformat inbound caller ID based on a trunk. The caller ID will be reformatted before it is sent to the called party.

For more information, see [Reformat Inbound Caller ID based on a Trunk](#).

Outbound Caller ID

Outbound caller ID is the phone number or name that is displayed on the called party's device.

You can set up a global outbound caller ID for a trunk or assign caller IDs for extension users.

 **Note:** By default, each trunk has a default phone number that will be displayed on the called party's device. Outbound Caller ID configuration requires support from the trunk

provider. Contact your trunk provider first before you configure Outbound Caller ID, or the settings won't take effect and outbound calls may fail.

If you set the caller ID number, when users make outbound calls through this trunk, the called party will see this caller ID number instead of the calling party's number.

For more information of outbound caller ID configurations, see [Customize Outbound Caller IDs](#)

Call Control

Emergency Calling

Emergency Calling Overview

This topic describes concepts that you need to know before managing emergency calling, including requirements and restrictions, basic emergency calling, and enhanced emergency calling.

Requirements

To make an emergency call, you should make sure the following requirements are met:

- IP phones or soft phones must be registered to Yeastar P-Series PBX System.
- At least one trunk should be configured for an emergency number.

Basic emergency calling

The basic emergency service only connects a caller to the local Public Safety Answering Point (PSAP), but no location is provided. Emergency callers must be ready to provide their location information for the PSAP. PSAP then arranges appropriate emergency response after communicating with the callers.

For more information, see [Set up Basic Emergency Calling](#).

Enhanced emergency calling

Enhanced emergency service is only available for specific countries and regions, such as E911 in North America, E112 in continental Europe, E999 in England, etc.

For an enhanced emergency call, PSAP can immediately pinpoint the caller's location based on the calling number.

⚠ Important: For wireless IP phones and soft phones (such as Linkus), the emergency caller's location can only be determined by the Emergency Outbound Caller ID configured on the PBX.

For more information, see [Set up Enhanced Emergency Calling](#).

Terminology

The following list defines the key terminology for enhanced emergency calling.

PSAP

A Public Safety Answering Point (PSAP) is responsible for receiving emergency calls and arranging appropriate emergency response, such as dispatching a police, fire, or ambulance team.

ERL

An Emergency Response Location (ERL) is a specific geographic location to which a emergency response team may be dispatched. To provide the PSAP with the emergency caller's precise location, you may need to set multiple ERLs.

ELIN

An Emergency Location Identification Number (ELIN) is the phone number (Caller ID), which is associated with an ERL. When an emergency call is made, the ELIN is displayed on the PSAP side so that they can match the caller ID with the ERL.

 **Note:** ELIN is also helpful for PSAP to call the emergency caller back in case the call is disconnected.

Examples of ERL/ELIN mapping:

- **One ERL for each building**

All the users in the same building are associated with the same ELIN.

ELIN	ERL
6085225672	No. 63-2 Wanghai Road, 2nd Software Park, Xiamen
6085225673	No. 63-3 Wanghai Road, 2nd Software Park, Xiamen

- **One ERL for each building floor**

All the users in the same floor of a building are associated with the same ELIN.

ELIN	ERL
6085225682	5/F, No. 63-2 Wanghai Road, 2nd Software Park, Xiamen
6085225683	4/F, No. 63-2 Wanghai Road, 2nd Software Park, Xiamen

- **One ERL for each room**

Each user of a room has a unique ELIN.

ELIN	ERL
6085225692	Room3005, No.1 Guanri Road, Software Park Siming District Xiamen
6085225693	Room3006, No.1 Guanri Road, Software Park Siming District Xiamen

Set up Basic Emergency Calling

To ensure that users can make emergency calls for help when an accident occurs, you need to set up emergency calling in Yeastar P-Series PBX System. This topic describes how to set up [basic emergency calling](#) in Yeastar P-Series PBX System.

Procedure

1. Log in to the PBX web interface, go to **Call Control > Emergency Number**, click **Add**.
2. In the **Name** field, specify a name to help you identify it.
3. In the **Emergency Number** field, enter the emergency number.
4. Leave the **Emergency Outbound Caller ID Priority** field as the default setting.

Note:

- **Emergency Outbound Caller ID Priority** setting is typically for [enhanced emergency calling](#), this setting will not affect basic emergency calling.
 - For basic emergency calling, you don't need to set Emergency Outbound Caller ID for extensions and trunks.
5. In the **Trunk's Emergency Outbound Caller ID** field, configure trunks for emergency calls.

 **Note:** Emergency calls have the highest priority. If the selected trunk is occupied, PBX will terminate the ongoing call, and place the emergency call.

- a. Click **Add**.
- b. In the drop-down list of **Trunk**, select a trunk.
- c. Leave the **Trunk's Emergency Outbound Caller ID** field blank.

 **Note:** Do not set emergency outbound caller ID for basic emergency calling, or the emergency calls may fail.

- d. Click **Add** to add another trunk and repeat **step a - step c**.

 **Note:** If the first trunk cannot work properly, the PBX will use the second trunk to make calls.

6. Click **Save** and **Apply**.

What to do next

After setting up an emergency calling, you may need to consider the following configurations:

- [Set up a Route for PSAP Callbacks](#)

Set up Enhanced Emergency Calling

To ensure that users can make emergency calls for help when an accident occurs, you need to set up emergency calling in Yeastar P-Series PBX System. This topic describes how to set up [enhanced emergency calling](#) in Yeastar P-Series PBX System.

Prerequisites

- Purchase enhanced emergency service from an Internet Telephony Service Provider (ITSP).

ITSP will provide DID numbers that are associated with your locations. DID number is also called Emergency Location Identification Number (ELIN).

Procedure

1. Log in to the PBX web interface, go to **Call Control > Emergency Number**, click **Add**.
2. In the **Name** field, specify a name to help you identify it.
3. In the **Emergency Number** field, enter the emergency number.
4. In the **Emergency Outbound Caller ID Priority** field, select which outbound caller ID will be sent to the Public Safety Answering Point (PSAP) in priority when an emergency call is made.
 - **Trunk's Emergency Outbound Caller ID:** Select this option if you want to set a common ELIN for all extension users. PSAP receives the trunk's emergency outbound caller ID no matter who makes the emergency call, which indicates PSAP receives a common location information.
 - **Extension's Emergency Outbound Caller ID:** Select this option if you want to [assign ELINs for individual users](#).
 - # Extension users with specific ELINs are associated with their respective locations.
 - # Extension users without specific ELINs share a common ELIN (the trunk's emergency outbound caller ID) and are associated with a common location.
5. In the **Trunk's Emergency Outbound Caller ID** field, configure trunks for emergency calls.
 - a. In the drop-down list of **Trunk**, select a trunk.

 **Note:** Emergency calls have the highest priority. If the selected trunk is occupied, PBX will terminate the ongoing call, and place the emergency call.

- b. In the **Trunk's Emergency Outbound Caller ID**, enter the Emergency Location Identification Number (ELIN) that you have purchased from the trunk provider.
- c. Click **Add** to add another trunk and repeat **step a - step c**.

 **Note:** If the first trunk cannot work properly, the PBX will use the second trunk to make calls.

6. Click **Save** and **Apply**.

Assign ELINs for individual users

To provide the PSAP with the emergency caller's precise location, you may need to purchase multiple ELINs and assign these ELINs to extension users.

1. Log in to the PBX web interface, go to **Extension and Trunk > Extension**, click to edit the desired extension.
2. On the extension **User** page, scroll down the page, enter the ELIN in the **Emergency Outbound Caller ID** field.
3. Click **Save** and **Apply**.

After the user dials an emergency number, the PSAP will locate the specific geographic location of the user by the extension user's ELIN.

What to do next

After setting up an emergency calling, you may need to consider the following configurations:

- [Set up a Route for PSAP Callbacks](#)

Set up a Route for PSAP Callbacks

In case that the emergency caller is not available to answer the returned call from PSAP, you can set up an inbound route to forward the call to an on-site security personnel.

Procedure

1. Log in to the PBX web interface, go to **Call Control > Inbound Routes**.
2. Click **Add** to add an inbound route for PSAP callbacks.
3. In the **Name** field, specify a name to help you identify it.
4. In the **Caller ID Match** section, add all the emergency numbers that you have set on the PBX.
 - a. Click **Add**.
 - b. In the **Patterns** field, enter the emergency number.

- c. To add another emergency number, repeat **step a - b**.
5. In the **Trunks** field, select the trunks that are used for emergency calls to the **Select-ed** box.
6. In the **Default Destination** field, select **Extension**, and select the user who is responsible for answering the returned calls from PSAP.
7. Leave other field as the default settings.
8. Click **Save** and **Apply**.

Result

When a PSAP operator calls back, the call will be forwarded to the extension user that is configured on the inbound route.

Related information

[Set up Basic Emergency Calling](#)

[Set up Enhanced Emergency Calling](#)

Manage Emergency Numbers

After you add emergency numbers, you can edit or delete them.

Edit an emergency number

1. Log in to PBX web interface, go to **Call Control > Emergency Number**, click  beside the emergency number that you want to edit.
2. Edit information of emergency number.
3. Click **Save** and **Apply**.

Delete an emergency number

1. Log in to PBX web interface, go to **Call Control > Emergency Number**, click  beside the emergency number that you want to delete.
2. In the pop-up dialog, click **OK** to confirm.
3. Click **Apply**.

Business Hours and Holidays

Overview of Business Hours and Holidays

This topic describes concepts that you need to know before managing business hours and holidays.

Time definition

The following list describes different types of time defined in the Yeastar P-Series PBX System.

Business Hours

Business Hours is the working hours during which you conduct business. A rest break that allows an employee to rest for a short period of time during working days is also considered as Business Hours.

Yeastar P-Series PBX System allows you to set a global business hours and also supports custom business hours for designated users.

- **Global Business Hours**

Global Business Hours is the main business hours for your company. Global Business Hours may apply to most of the employees who have fixed work schedules.

For more information, see [Set Global Business Hours](#).

- **Custom Business Hours**

Custom Business Hours is typically for departments with different hours from your main business hours. You need to create custom schedules that accommodate each department's unique hours and call handling needs.

For more information, see [Route Inbound Calls based on Department Hours](#).

Holidays

Holiday defines the days your business is closed due to a holiday. Holidays can be divided into two types:

- Fixed-date Holidays
- Moveable-date Holidays

You can add holidays by date, month, or week according to the holiday type. For more information, see [Create a Holiday](#).

Outside Business Hours

Outside Business Hours is the time periods that are not defined as Business Hours or Holidays.

What is the Business Hours and Holidays used for?

Business Hours and Holidays can be applied to an Inbound Route, an Outbound Route, or Presence Switch.

Apply to an Inbound Route and Outbound Route

Business Hours and Holidays is typically applied in an Inbound Route to control destination of incoming calls based on date and time; and can be also applied in an Outbound Route to limit the use of the Outbound Route based on date and time.

Apply to Extension Presence Switch

Business Hours and Holidays can be applied to automatically switch the extension presence status, regardless of the current presence status.

Global Business Hours

Set Global Business Hours

This topic gives a configuration example to introduce how to set up global business hours for your company.

Background information

Global Business Hours is the main business hours for your company. Global Business Hours may apply to most of the company employees who have fixed work schedules.

This topic assumes that your business hours is as follows:



- **Working days:** Monday to Friday
- **Working hours:** 09:00-12:00 and 14:00-18:00
- **Lunch break:** 12:00-14:00

Procedure

1. Log in to the PBX web interface, go to **Call Control > Business Hours and Holidays**.
2. On the **Business Hours** page, click **Add**.
3. In the pop-up window, configure your business hours:
 - a. In the **Business Hours** section, click **Add**, and specify the hours when your business is open.



 **Tip:** You can enter the time directly in the text field to quickly set the time.

In this scenario, set the **Start Time** to *9:00* and set the **End Time** to *18:00*.

Business Hours		
Start Time	End Time	Operations
09:00 	18:00 	
+ Add		







- b. In the **Break Hours** section, click **Add**, and specify reset breaks during the working days.

In this scenario, set the **Start Time** to 12:00 and set the **End Time** to 14:00.

Break Hours		
Start Time	End Time	Operations
12:00 	14:00 	
+ Add		

- c. In the **Days of week** section, select your working days.

In this scenario, select Monday to Friday.

Days of week					
Monday 	Tuesday 	Wednesday 	Thursday 	Friday 	

- d. Click **Save** and **Apply**.

Result

- A time group is created for Global Business Hours. In this scenario, the configured time group is defined as below:

Business Hours:

Monday to Friday, 09:00-18:00

Outside Business Hours:

Monday to Friday, 18:00 - 23:59, 00:00 - 08:59

Saturday and Sunday, 00:00 - 23:59

- You can create more time groups according to your company's business hours. All the time groups created on the **Business Hours** page are regarded as your company's global business hours.

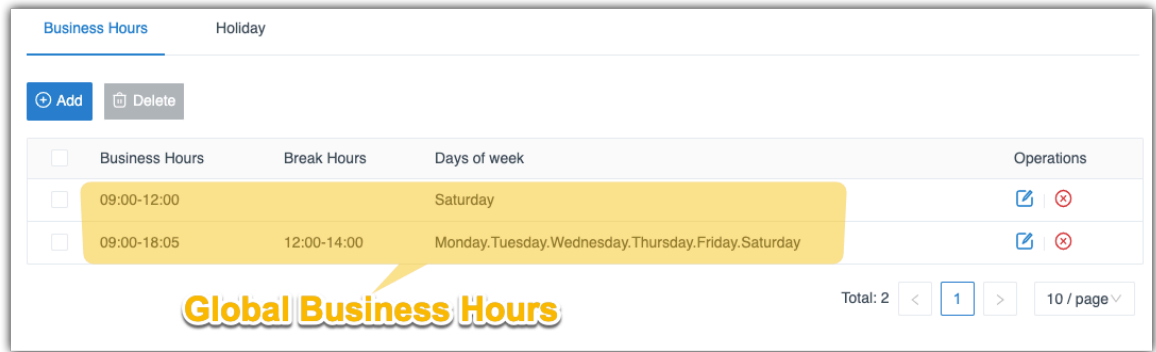

What to do next

- To create call schedules based on the Global Business Hours, see [Route Inbound Calls based on Global Business Hours](#).
- To limit users to make outbound calls based on the Global Business Hours, see [Set up an Outbound Route](#).

Manage Global Business Hours

This topic describes how to edit and delete the time groups that you've defined as your Global Business Hours.

Edit a time group of Global Business Hours

1. Log in to the PBX web interface, go to **Call Control > Business Hours and Holidays**.
2. On the **Business Hours** page, select a desired time group, click .
3. In the pop-up window, change the time settings.
4. Click **Save** and **Apply**.

The Global Business Hours is updated.

Delete a time group of Global Business Hours

1. Log in to the PBX web interface, go to **Call Control > Business Hours and Holidays**.
2. On the **Business Hours** page, select a desired time group, click **Delete**.
3. In the pop-up dialog box, click **Yes** to confirm.

The time group is deleted from the Global Business Hours.

Allow Users to Switch Business Hours Status

If you have configured a time-based inbound route, the system will automatically route calls to different destinations based on the time. However, users may need to force open or close business occasionally. This topic describes how to allow users to switch Business Hours status.

Background information

Scenarios

Users may need to override time condition in the following scenarios:

- **Temporary night shift**

After business hours, the employee who needs to work in the night can force open the business hours to provide communication services for customers.

- **Occasionally leaving**

Your company may close the business earlier than usual on a special day. For example, your company will close the business one hour in advance on the Christmas day and you can force close business before you leave.

 **Note:** If [presence auto switch based on Business Hours](#) and Holidays is enabled for extension users, their presence status will be switched when Business Hours Status is switched.

Methods

Yeastar P-Series PBX System provides two methods to switch Business Hours status. The permission configurations are different for different methods:

- [Allow users to switch Business Hours status by feature code](#)
- [Allow users to switch Business Hours status on Operator Panel](#)

Allow users to switch Business Hours status by feature code

Procedure

1. Log in to the PBX web interface, go to **Call Features > Feature Code**.
2. Check the feature code of **Switch Business Hours Status**.
The default feature code is *99. You can use the default one or change it according to your needs.
3. In the **Permission** field, select the extension users.
4. Click **Save** and **Apply**.

Result

The allowed users can dial feature code (default *99) on their phones to switch the current Business Hours status to another one.

 **Note:** The Business Hours status will automatically return to a normal status based on the system time.

- If the status is Business Hours, dial *99 to force switch the status to Outside Business Hours.
- If the status is Outside Business Hours, dial *99 to force switch the status to Business Hours.
- If the status is Holiday, dial *99 to force switch the status to Business Hours, dial *99 again to switch the status back to Holiday.

Allow users to switch Business Hours status on Operator Panel

You can assign the permission of switching Business Hours status to an extension group manager or a specific user with custom permissions.

Allow an extension group manager to switch Business Hours status

1. Log in to the PBX web interface, go to **Extension and Trunk > Extension Group**.
2. Select an extension group, and click .
3. On the **Extension Group** page, click **Group Permissions** tab.
4. In **Permission Configuration** section, select the checkbox of **Switch Business Hours and Holidays status**.

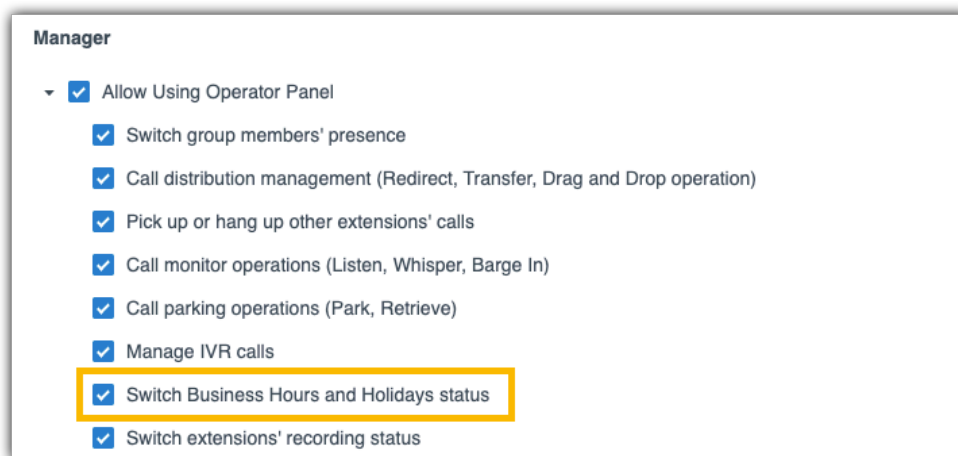

5. Click **Save** and **Apply**.

The user whose user type is Manager can switch Business Hours status on Operator Panel.

For more information of the operations, see [Operator Panel User Guide](#).

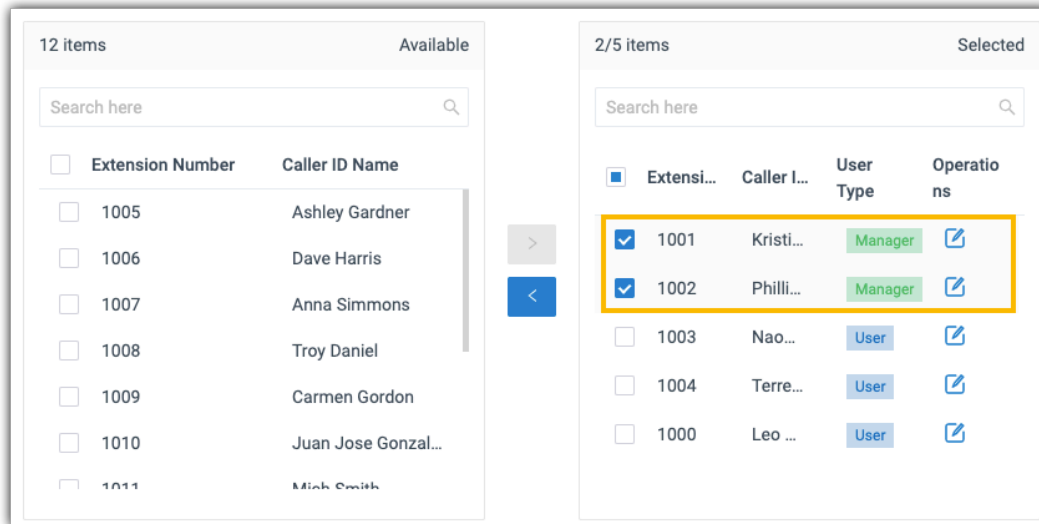

Allow a specific user to switch Business Hours status

1. Log in to the PBX web interface, go to **Extension and Trunk > Extension Group**.
2. Select an extension group, and click
3. In the **Members** section, edit an extension in the **Selected** box.
 - a. Select **User Type** to **Custom**.
 - b. Select the checkbox of **Switch Business Hours and Holidays status**.
 - c. Click **Save**.

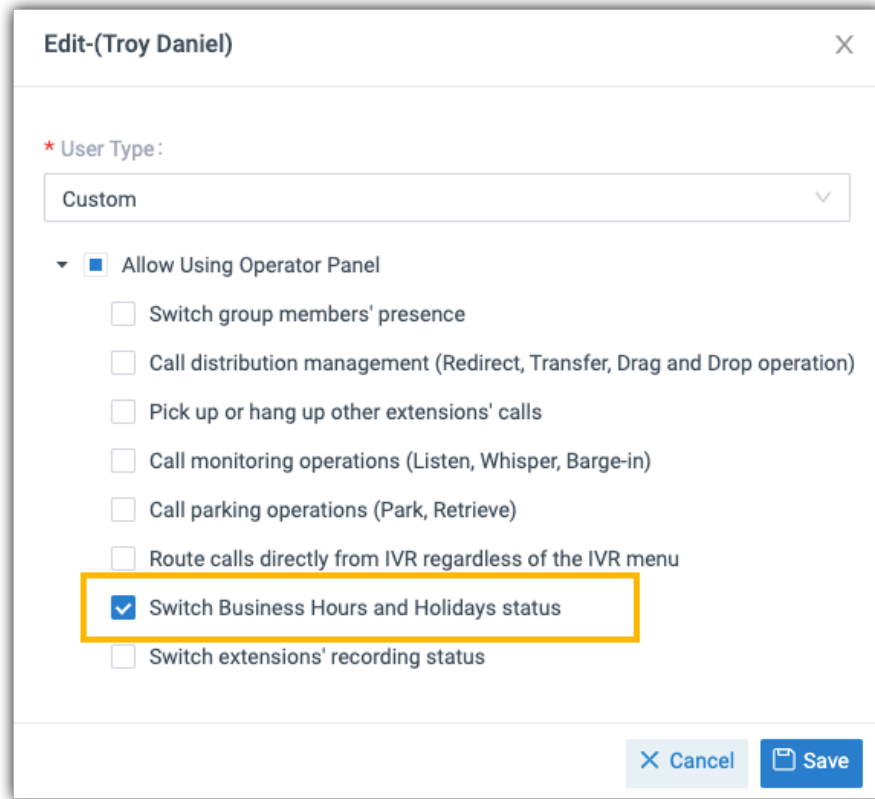

The permitted the user can switch Business Hours status on Operator Panel. For more information of the operations, see [Operator Panel User Guide](#).

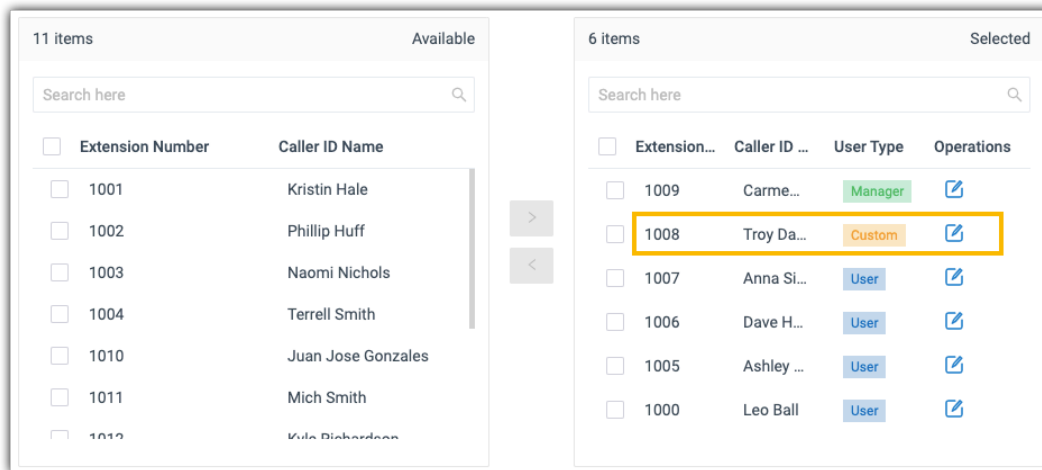

What to do next

To monitor the Business Hours status, see [Monitor Business Hours Status](#).

Monitor Business Hours Status

You can monitor Business Hours status to ensure that the system is working based on the desired time periods. This topic describes how to monitor Business Hours status by a BLF key on a IP phone.

Background information

For the users that want to monitor Business Hours Status on their phones, you can set a BLF key for each user by [auto provisioning](#).

 **Note:** Users can also set function keys on their own IP phones. For more information, contact the phone manufacturer.

The users who have [permission to access the Operator Panel](#) can monitor Business Hours Status on the web page directly. For more information, see [Yeastar Operator Panel User Guide](#).

Prerequisites

- Only the permitted extension user can monitor and switch Business Hours status by a BLF key. For more information, see [Allow users to switch Business Hours status by feature code](#).

Procedure

1. Assign function keys for extension users to monitor agent status.
 - a. Log in to the PBX web interface, go to **Extension and Trunk > Extension**, edit the desired extension.
 - If you want to assign function keys for a specific extension user, click  beside the desired extension.
 - If you want to assign function keys for multiple extensions, select the checkboxes of the desired extensions, and click **Edit**.
 - b. Click the **Function Keys** tab.
 - c. Configure function keys.

 **Note:** The number of programmable keys varies by phone models. If the number of function keys you assign to an extension exceeds the number of programmable keys, the redundant function keys cannot take effect.

- **Type:** Select **BLF**.
 - **Value:** Enter the feature code of **Switch Business Hours** (*99).
 - **Label:** Optional. Enter a value, which will be displayed on the phone screen.
- d. Click **Save**.
2. If the extension haven't be associated with a phone, see [Auto Provision IP Phones](#) to bind a phone with the extension.

3. If the extension have been associated with a phone, reprovision the phone to take effect.
 - a. Go to **Auto Provisioning > Phones**.
 - b. Click  beside the phone assigned to this extension.

Result

Different status of BLF LED indicates different status.

- **Red:** The system is in the status of **Outside Business Hours** or **Holiday**.
- **Green:** The system is in the status of **Business Hours**.
- **Off:** The BLF configurations are incorrect.

Holidays

Create a Holiday

This topic describes how to create holidays by date, week, and month.

Create a holiday by date

If the holiday date varies every year, you can create a holiday by date.

Example

Chinese Spring Festival varies every year, and 2020 Chinese Spring Festival falls on Jan. 24 to Feb. 8. You can set the holiday as follows.

Configuration Example

1. Log in to the PBX web interface, go to **Call Control > Business Hours and Holidays > Holidays**.
2. On the **Holidays** page, click **Add**.
3. In the pop-up window, configure the holiday by date.

- **Name:** Enter the holiday name *2020 Chinese Spring Festival*.
- **Holiday Type:** Select **By Date**.
- **Date:** Select the holiday start date and end date.

4. Click **Save** and **Apply**.

Create a holiday by month

If the holiday always falls on the same date, you can set a holiday by month.

Example

The Christmas falls on Dec. 25 every year. You can set the holiday as follows.

Configuration Example

1. Log in to the PBX web interface, go to **Call Control > Business Hours and Holidays > Holidays**.
2. On the **Holidays** page, click **Add**.
3. In the pop-up window, configure the holiday by month.

The screenshot shows a dialog box titled "Edit Holiday" with a close button (X) in the top right corner. The dialog contains three required fields, each marked with a red asterisk (*):

- Name:** A text input field containing the text "Christmas".
- Holiday Type:** A dropdown menu with "By Month" selected and a downward arrow on the right.
- Date:** A date range input field showing "12/25" followed by a tilde (~) and another "12/25", with a calendar icon on the right.

At the bottom right of the dialog, there are two buttons: a light blue "Cancel" button with an 'X' icon and a dark blue "Save" button with a floppy disk icon.

- **Name:** Enter the holiday name *Christmas*.
- **Type:** Select **By Month**.
- **Date:** Select the holiday start date and end date.

4. Click **Save** and **Apply**.

Create a holiday by week

If a holiday always falls on the same week, you can set a holiday by week.

Example

Thanksgiving Day falls on the fourth Thursday of November. You can set the holiday as follows.

Configuration Example

1. Log in to the PBX web interface, go to **Call Control > Business Hours and Holidays > Holidays**.
2. On the **Holiday** page, click **Add**.
3. In the pop-up window, configure the holiday by week.

- **Name:** Enter the holiday name *Thanksgiving Day*.
 - **Holiday Type:** Select **By Week**.
 - **Date:** Select the month and the day of a specific week.
4. Click **Save** and **Apply**.

What to do next

- To set up holiday schedules for inbound calls, see [Set up an Inbound Route](#).
- To limit users to make outbound calls during holidays, see [Set up an Outbound Route](#).

Manage Holidays

This topic describes how to edit and delete a holiday.

Edit a holiday

1. Log in to the PBX web interface, go to **Call Control > Business Hours and Holidays > Holidays**.
2. On the **Holidays** page, select a desired holiday, click .
3. In the pop-up window, change the holiday settings.
4. Click **Save** and **Apply**.

The holiday list is updated.

Delete a holiday

1. Log in to the PBX web interface, go to **Call Control > Business Hours and Holidays > Holidays**.
2. On the **Holidays** page, select a desired holiday, click **Delete**.
3. In the pop-up dialog box, click **Yes** to confirm.

The holiday is deleted from the holiday list.

Inbound Route

Inbound Route Overview

An inbound route allows external callers to reach your system and routes the inbound calls to a specific destination based on the pre-configured rules and criteria.

Types of inbound call routing

Yeastar P-Series PBX System has the following types of inbound call routing based on different criteria, such as time, DID numbers, and Caller IDs.

Note:

- If you don't specify any criteria on an inbound route, there will be no restriction on the inbound route. The system will route all inbound calls to the inbound route destination.
- You can set up multiple criteria on an inbound route. For example, route inbound calls based on time and DID number, or route inbound calls based on DID number and Caller ID number.

Time-based call routing

Time-based call routing connects callers to a destination based on the time that they call. The inbound calls are handled differently according to your company's time schedules.

For more information, see the following topics:

- [Route Inbound Calls based on Global Business Hours](#)
- [Route Inbound Calls based on Department Hours](#)
- [Route Inbound Calls based on Employee Hours](#)

DID-based call routing

DID-based call routing connects callers to a destination based on the phone numbers (also known as DID) that the callers dial. Only when the dialed DID

numbers match the DID rules on the inbound route will the calls be routed to the destination.

For more information, see [Route Inbound Calls based on DID Numbers](#).

Caller-ID-based call routing

Caller-ID-based call routing allows you to accept or reject calls based on the caller's phone number. Inbound calls that match the Caller ID pattern on PBX will be routed to the pre-configured destination. For those unmatched, calls can not be established.

For more information, see [Route Inbound Calls based on Caller ID](#).

Inbound route destinations

Yeastar P-Series PBX System provides various inbound destinations to meet your business needs.

The following options are available to help you decide the inbound route destinations:

- **Extension**
- **Extension Voicemail**
- **Match Selected Extensions**
- **DID Range to Extension Range**
- **DID Pattern to Selected Extensions**
- **IVR**
- **Ring Group**
- **Queue**
- **Conference**
- **External Number**
- **Outbound Route**
- **Fax to Email**
- **Hang up**
- **Play Greeting then Hang up**

Set up an Inbound Route

To receive inbound calls from external users, you need to set up at least one inbound route.

Background information

Yeastar P-Series PBX System has a default inbound route that will route all the inbound calls to an IVR. You can delete the default inbound route, and add a new one to configure settings according to your needs.

Prerequisites

Ensure that you have set up at least one trunk for external users to call in.

Procedure

1. Log in to the PBX web interface, go to **Call Control > Inbound Route**, click **Add**.
2. In the **Name** field, enter a name to help you identify it.
3. **Optional:** If you want to route inbound calls based on DID numbers, configure **DID Pattern**.

The PBX will route inbound calls only when the callers dial the matched DID numbers.

 **Note:** Leave this field blank to match calls with any or no DID information.

For more information, see [Route Inbound Calls based on DID Numbers](#).

4. **Optional:** If you want to route inbound calls based on Caller IDs, configure **Caller ID Pattern**.

The PBX will route inbound calls only when the Caller IDs match the Caller ID pattern.

 **Note:** Leave this field blank to match calls with any or no Caller ID info.

For more information, see [Route Inbound Calls based on Caller ID](#).

5. In the **Trunk** field, select the desired trunks from **Available** box to **Selected** box.

The PBX will route inbound calls through this inbound route when external users call the selected trunk number.

6. Configure the inbound route destination.
 - If you want to route inbound calls to one destination whenever the calls reach the system, perform the following operations:
 - a. Keep the **Time Condition** unselected.
 - b. Configure the **Default Destination**.
 - If you want to route inbound calls to different destinations based on the time, perform the following operations:
 - a. Select the checkbox of **Time Condition**.
 - b. Select an option from the drop-down list of **Time-based Routing Mode**.
 - c. Configure the destinations based on the time.

If an inbound call reaches the PBX during the time period, PBX will route the call to the selected destination.

For more information of inbound call routing based on time, see the following topics:

- # [Route Inbound Calls based on Global Business Hours](#)
- # [Route Inbound Calls based on Department Hours](#)
- # [Route Inbound Calls based on Employee Hours](#)

7. **Optional:** To receive faxes through this inbound route, enable **Fax Detection** and configure the fax destination.

- **Extension:** The faxes will be sent to the selected extension.
 - # For an FXS extension, you need to connect a fax machine to the relevant FXS port to receive faxes.
 - # For a SIP extension, you need to register the extension on a SIP compatible fax machine.

 **Note:** If the selected extension is deleted, the fax destination will automatically jump to **Hang up**, and faxes cannot be received through this inbound route.

- **Fax to Email:** The faxes will be converted to email attachments and be sent to an extension's email address.

 **Note:** Make sure the system email is configured correctly, or **Fax to Email** will fail to work.

For more information of fax setting, see [Fax Overview](#).

8. Click **Save** and **Apply**.

Inbound Route Examples

Route Inbound Calls based on Global Business Hours

This topic gives a configuration example to describe how to configure inbound route to control inbound calls based on Global Business Hours, which can be applied to most of the employees.

Background information

Assume that your company's business hours are as follows:

- **Working days:** Monday to Friday
- **Business hours:** 09:00-12:00 and 14:00-18:00

When customers call in the trunk FXO-5503301, you want to route the calls based on the time as follows:

- During business hours, route inbound calls to an IVR for business.
- During a holiday, route inbound calls to another IVR for holiday.
- For other time periods, route inbound calls to a voicemail.

Prerequisites

- The trunk for inbound calling has been set up and is ready for use.
- [Global Business Hours is configured](#) according to your company's business hours.
- The desired destination of the inbound route has been configured on the system.

In this scenario, an IVR for business hours, an IVR for holiday should be preconfigured.

For more information of IVR, see [Set up an IVR](#).

- If you want to set up multiple inbound routes for different time schedules, each inbound route should be associated with a different trunk or a trunk with different DID numbers. In this way, the inbound calls can be always be directed to your desired destination.

How to configure inbound route based on DID numbers, see [Route Inbound Calls based on DID Numbers](#).

Procedure

1. Log in to the PBX web interface, go to **Call Control > Inbound Route**, click **Add**.
2. In the **Name** field, enter a name to help you identify it.
3. In the **Trunk** section, select the desired trunks from **Available** box to **Selected** box.

In this scenario, select the trunk **FXO-5503301**.

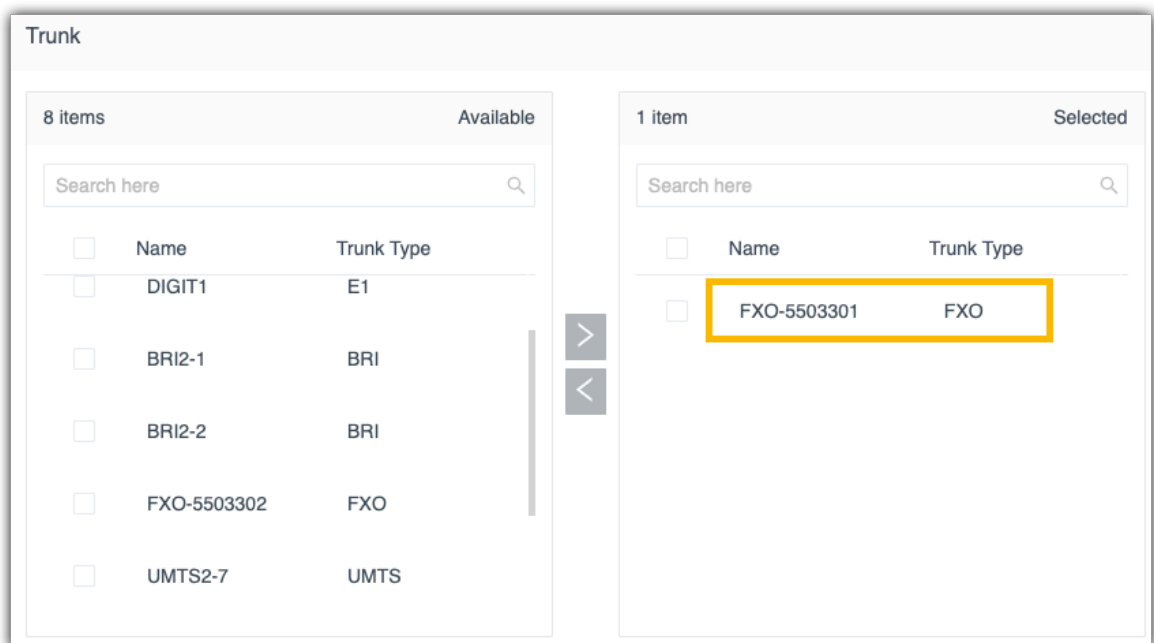

4. In the **Default Destination** section, complete the following operations:
 - a. Select the checkbox of **Time Condition**.
 - b. In the drop-down list of **Time-based Routing Mode**, select **Based on Global Business Hours**.
 - c. Configure the following destinations based on the time.
 - **Business Hours Destination**: Select the destination for inbound calls during [global business hours](#).

In this scenario, select **IVR**, and select the IVR for business hours.

- **Outside Business Hours Destination:** Outside Business Hours is the time periods that are not defined as Business Hours or Holidays.

In this scenario, select **Extension Voicemail** then select an extension number.

- **Holidays Destination:** Select the destination for inbound calls during [holidays](#).

In this scenario, select **IVR**, and select the IVR for holidays.

Default Destination

Time Condition

* Time-based Routing Mode

Based on Global Business Hours

Business Hours Destination *

IVR InBusiness

Outside Business Hours Destination *

Extension Voicemail 1002-Helen

Holidays Destination *

IVR Holidays

5. Click **Save** and **Apply**.

Result

When customers make calls to the phone number of the selected trunk (FXO-5503301), the calls will be routed to different destinations based on the time.

Route Inbound Calls based on Department Hours

This topic gives a configuration example to describe how to configure inbound route to control inbound calls for the departments that maintain different hours from the company's global business hours.

Scenarios

The employees in the branch office's support department have different business hours from the head office. The department hours is listed as below:

- **Working days:** Monday to Friday
- **Business hours:** 21:00 - 23:00 and 00:00 - 05:00

When customers call in the trunk FXO-5503302, you want to route the calls based on the time as follows:

- During business hours, route inbound calls to the support team's queue.
- During a holiday, route inbound calls to another IVR for holiday.
- For other time periods, route inbound calls to a voicemail.

Prerequisites

- The trunk for inbound calling has been set up and is ready for use.
- The desired destination of the inbound route should be configured on the system.

In this scenario, a queue and an IVR for holiday should be preconfigured.

For more information of the configurations of queue and IVR, see [Create a Queue](#) and [Set up an IVR](#).

- If you want to set up multiple inbound routes for different time schedules, each inbound route should be associated with a different trunk or a trunk with different DID numbers. In this way, the inbound calls can be always be directed to your desired destination.

How to configure inbound route based on DID numbers, see [Route Inbound Calls based on DID Numbers](#).

Procedure

1. Log in to the PBX web interface, go to **Call Control > Inbound Route**, click **Add**.
2. In the **Name** field, enter a name to help you identify it.
3. In the **Trunk** section, select the desired trunks from **Available** box to **Selected** box.

In this scenario, select the trunk **FXO-5503302**.

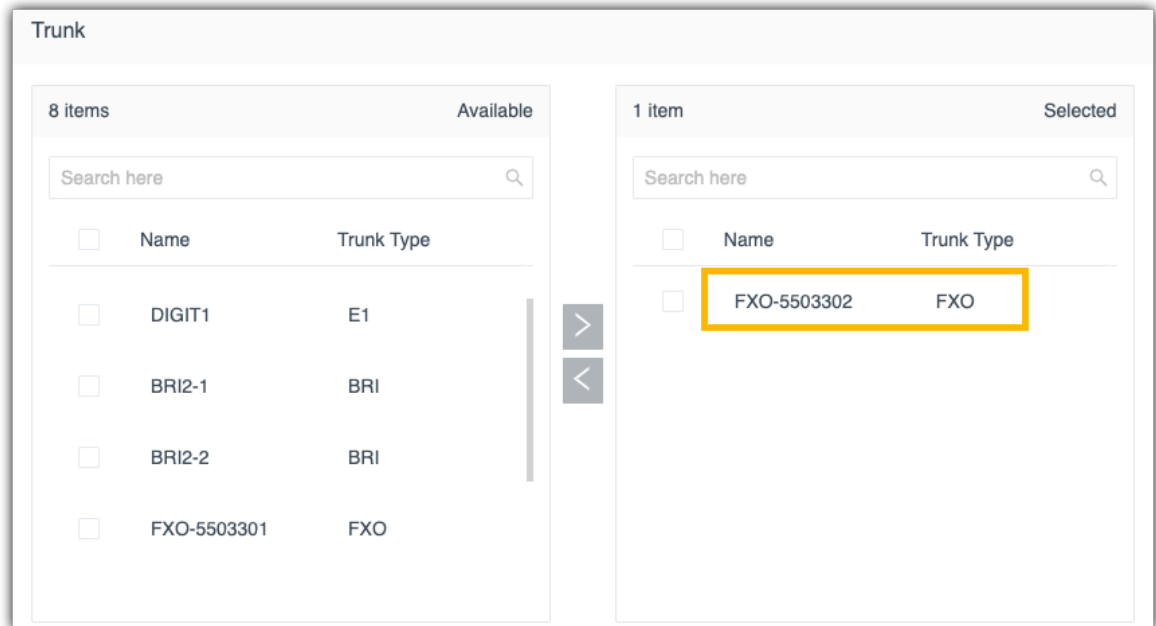

4. In the **Default Destination** section, complete the following operations:
- Select the checkbox of **Time Condition**.
 - In the drop-down list of **Time-based Routing Mode**, select **Based on Custom Business Hours**.

- Configure custom business hours.
 - Click **Add Custom Business Hours**.
 - In the pop-up window, click **Add** to add time periods and select days of week.

In this scenario, add two time periods, 21:00 - 23:00 and 00:00 - 05:00; select days from Monday to Friday.

- Click **Save**.
- Configure the following destinations based on the time.
 - **Business Hours Destination:** Select the destination for inbound calls during [global business hours](#).

In this scenario, select **Queue**, and select the Queue "Support Team".

 - **Outside Business Hours Destination:** Outside Business Hours is the time periods that are not defined as Business Hours or Holidays.

In this scenario, select **Extension Voicemail** then select an extension number.

- **Holidays Destination:** Select the destination for inbound calls during [holidays](#).

In this scenario, select **IVR**, and select the IVR for holidays.

Default Destination

Time Condition

* Time-based Routing Mode

Based on Custom Business Hours

[+ Add Custom Business Hours](#) [Delete](#)

<input type="checkbox"/> Custom Business Hours	Days of Week	Operations
<input type="checkbox"/> 21:00-23:00;00:00-05:00	Monday.Tuesday.Wednesday.Thursday.Friday	✎ ✖

Business Hours Destination *

Queue 6400-Support Team

Outside Business Hours Destination *

Extension Voicemail 1000-Leo Ball

Holidays Destination *

IVR 6201-Holidays

5. Click **Save** and **Apply**.

Result

When customers make calls to the phone number of the selected trunk (FXO-5503302), the calls will be routed to different destinations based on time.

Route Inbound Calls based on Employee Hours

This topic gives a configuration example to describe how to configure inbound route to control inbound calls for individual employees who have their own work schedules.

Scenarios

Duty doctors in a hospital are responsible for supporting emergency patient needs or arranging appointments for patients over phone calls.

- Each duty doctor has a different time schedule and will provide services based on the time schedule.
- During the time periods that no doctors are on duty or when it comes to a holiday, the incoming calls from patients will be routed to an IVR.

The following shows time schedule for the duty doctors.

Doctor Name	Time Schedule
Dr. Tommy Tse	Monday 07:00 -12:00 Friday 12:00 - 18:00
Dr. Eric Chan	Monday 00:00 - 07:00 Thursday 07:00 - 12:00

Prerequisites

- The trunk for inbound calling has been set up and is ready for use.
- The desired destination of the inbound route should be configured on the system.

In this scenario, an IVR should be configured to ensure that patients can reach their desired services.

For more information of IVR, see [Set up an IVR](#).

- If you want to set up multiple inbound routes for different time schedules, each inbound route should be associated with a different trunk or a trunk with different DID numbers. In this way, the inbound calls can be always be directed to your desired destination.

How to configure inbound route based on DID numbers, see [Route Inbound Calls based on DID Numbers](#).

Procedure

1. Log in to the PBX web interface, go to **Call Control > Inbound Route**, click **Add**.
2. In the **Name** field, enter a name to help you identify it.
3. In the **Trunk** section, select the desired trunks from **Available** box to **Selected** box.

In this scenario, select the trunk **FXO-5503303**.

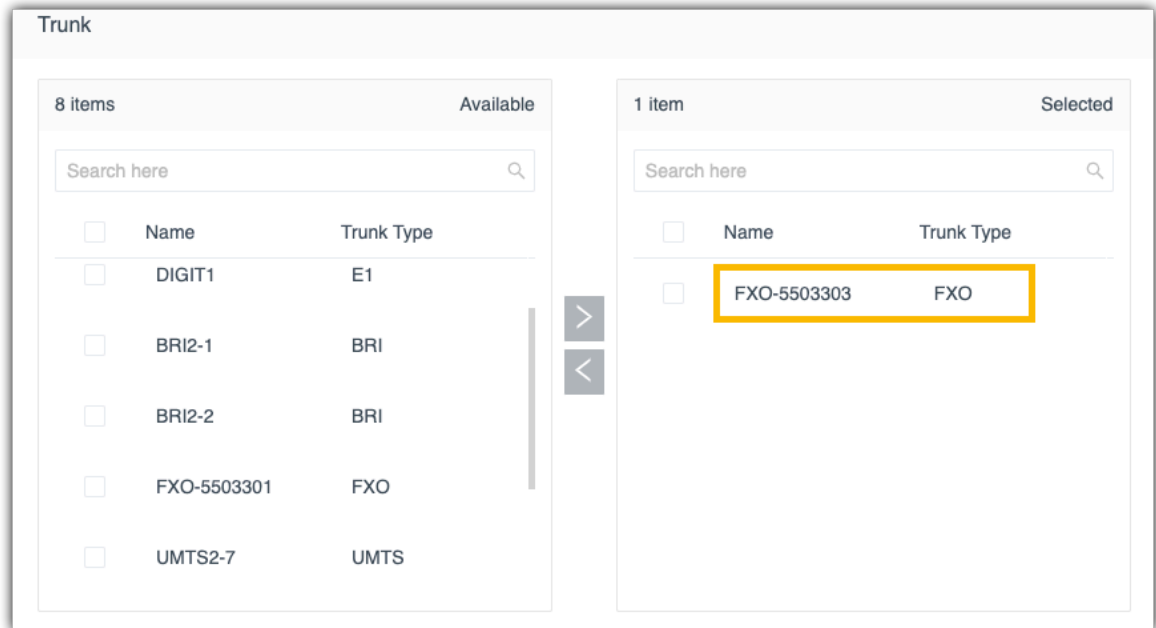

4. In the **Default Destination** section, complete the following operations:
 - a. Select the checkbox of **Time Condition**.
 - b. In the drop-down list of **Time-based Routing Mode**, select **Based on Custom Time Periods**.
 - c. Add time schedule for the duty doctors.
 - i. Click **Add Custom Time Periods**.
 - ii. In the pop-up window, click **Add** to add time periods, select days of week and set the relevant destination.
 - iii. Click **Save**.
 - iv. Repeat **step i - iii** to add another time schedule.

In this scenario, add four time schedules as below.

Start Time	End Time	Days of Week	Destination
07:00	12:00	Monday	Tommy's extension
12:00	18:00	Friday	Tommy's extension
00:00	07:00	Monday	Eric's extension
07:00	12:00	Thursday	Eric's extension

- d. Configure the **Holiday Destination**.

In this scenario, select **IVR**, and select an IVR to guide patients.
- e. Configure the **Default Destination**.

In this scenario, select **IVR**, and select an IVR to guide patients.

Time Condition

* Time-based Routing Mode

Based on Custom Time Periods

[+ Add Custom Time Periods](#) [Delete](#)

<input type="checkbox"/>	Custom Time Periods	Days of Week	Destination	Move
<input type="checkbox"/>	07:00-12:00	Monday	Extension	↑ ^ v ↓
<input type="checkbox"/>	12:00-18:00	Friday	Extension	↑ ^ v ↓
<input type="checkbox"/>	00:00-07:00	Monday	Extension	↑ ^ v ↓
<input type="checkbox"/>	07:00-12:00	Thursday	Extension	↑ ^ v ↓

Holidays Destination *

IVR 24-Hours-Services

Default Destination *

IVR 24-Hours-Services

5. Click **Save** and **Apply**.

Result

When external users make calls to the phone number of the selected trunk (FXO-5503303), the calls will be routed to different destinations based on time:

- During the custom time periods, inbound calls go to the specified destination.
- During the rest of time that is not defined, inbound calls go to the **Default Destination**.
- When it comes to holiday, inbound calls go to the **Holiday Destination**.

Route Inbound Calls based on DID Numbers

This topic gives configuration examples to describe how to route inbound calls based on the dialed numbers (also called DID numbers).

DID routing modes

Yeastar P-Series PBX System provides three DID matching modes to help you route inbound calls based on DID numbers.

- **Match DID Range to Extension Range**

Match DID Range and Extension Range in one-to-one correspondence.

See configuration example [Route calls to extension users by matching DID range.](#)

- **Match DID Pattern to Extensions**

Use the variable `{{ .Ext }}` to match extension number in the DID pattern.

See configuration example [Route calls to extension users by matching specific DIDs.](#)

- **DID Pattern**

The calls match the defined DID(s) will be routed to a defined destination.

See configuration example [Route calls to a specific destination by matching DID patterns.](#)

Route calls to extension users by matching DID range

Background information

Company ABC purchases a SIP trunk, and gets 10 DID numbers that are in order: 8823201-8823210.

The company wants to redirect inbound calls to specific extensions based on the provided DID numbers as follows:

Table 23.

DID Number	Extension Number
8823201	1001
8823202	1002
8823203	1003
8823204	1004
8823205	1005
8823206	1006
8823207	1007
8823208	1008
8823209	1009
8823210	1010

Prerequisites

- You have purchased DID numbers from the trunk provider.
- The trunk for inbound calling has been set up and is ready for use.

 **Note:** PSTN trunk and GSM trunk have no DID numbers, this solution is not suitable for these kinds of trunks.

Configuration example

According to this scenario, configure an inbound route based on DIDs as follows:

- **Name:** Enter a name to help you identify it.
- **DID Pattern:**
 - # **DID Matching Mode:** Select **Match DID Range to Extension Range**.
 - # **DID Range:** Enter the start number and the end number of the DID range.

In this scenario, enter *8823201* and *8823210*.

DID Pattern

* DID Matching Mode: Match DID Range to Extension Range

* DID Range: 8823201 - 8823210

- **Caller ID Pattern:** Leave it blank, which means no limit on the inbound caller ID.
- **Trunk:** Select the trunk that binds the DID numbers.
- **Default Destination:** Decide whether to route inbound calls to different destinations based on time and configure the destinations.

In this scenario, route inbound calls to the default destination whenever the calls reach the system.

- # **Default Destination:** Select **Match Extension Range**, and enter the extension range *1001 - 1010*.

 **Note:** The DID range and extension range should have the same size (for example, DID range 991000-991003 and the extension range 1000-1003 have the same size).

- # **Time Condition:** Unselected.

Default Destination

Default Destination: Match Extension Range

1001 - 1010

Time Condition

- **Fax Detection:** Leave the settings as default.

Result

When an external user dials a number that is in the DID range, the user can reach a corresponding extension user directly.

For example, if an external user dials 8823201, the call goes to the extension 1001 directly.

Route calls to extension users by matching specific DIDs

Scenarios

Company ABC purchases a SIP trunk, and gets 3 DID numbers as follows.

- 8821001, 8821006, 8821016

The company wants to redirect inbound calls to specific extensions based on the provided DID numbers as follows:

 **Note:** The provided DIDs have the following characteristics:

- Not consecutive
- Each DID number consists of a string of fixed digits and a specific extension number.

Table 24.

DID Number	Extension Number
8821001	1001
8821006	1006
8821016	1016

Prerequisites

- You have purchased DID numbers from the trunk provider.
- The trunk for inbound calling has been set up and is ready for use.

 **Note:** PSTN trunk and GSM trunk have no DID numbers, this solution is not suitable for these kinds of trunks.

Configuration example

According to this scenario, configure an inbound route based on DIDs as follows:

- **Name:** Enter a name to help you identify it.
- **DID Pattern:**
 - # **DID Matching Mode:** Select **Match DID Pattern to Extensions**.
 - # **DID Pattern:** Enter the DID pattern according to the provided DIDs.

In this scenario, enter `882{{.Ext}}` .

 **Note:**

- # `{{.Ext}}` is a variable that will match the destination extension.
- # The wildcard `*` and `!` are not allowed.
- # Only one DID pattern is allowed.

DID Pattern

* DID Matching Mode: Match DID Pattern to Extensions

* DID Pattern: 882{{.Ext}}

- **Caller ID Pattern:** Leave it blank, which means no limit of inbound caller ID.
- **Trunk:** Select the trunk that binds the DID numbers.

In this scenario, select **siptrunk**.

- **Default Destination:** Decide whether to route inbound calls to different destinations based on time and configure the destinations.

In this scenario, route inbound calls to the default destination whenever the calls reach the system.

Default Destination: Select **Match Selected Extensions**, and select extensions.

In this scenario, select extension 1001, 1006, and 1016.

Time Condition: Unselected.

Default Destination

Default Destination: Match Selected Extensions

Time Condition:

Selected Extensions: 1001-Becky Lai ×, 1016-Jenny ×, 1006-Candy ×

- **Fax Detection:** Leave the settings as default.

Result

When an external user dials a number that matches the DID pattern, the user can reach a specific extension user directly.

For example, if the external user dials 8821001, the call goes to the extension 1001 directly.

Route calls to a specific destination by matching DID patterns

Scenario

Company ABC purchases a SIP trunk, and gets 2 DID numbers as follows.

- 88866608
- 88866609

The company wants to assign the two DID numbers to support team and sales team.

- When external users call 88866609, the calls go directly to support team.
- When external users call 88866608, the calls go directly to sales team.

Prerequisites

- You have purchased DID numbers from the trunk provider.
- The trunk for inbound calling has been set up and is ready for use.

 **Note:** PSTN trunk and GSM trunk have no DID numbers, this solution is not suitable for these kinds of trunks.

Configuration example

Set up two inbound routes to route calls to different destinations based on DID numbers.

Inbound Route for sales team

- **Name:** Enter a name to help you identify it.
- **DID Pattern:**
 - # **DID Matching Mode:** Select **DID Pattern**.
 - # **DID Patterns:** Click **Add** and enter a DID pattern or a DID number.

In this scenario, enter *88866608*.

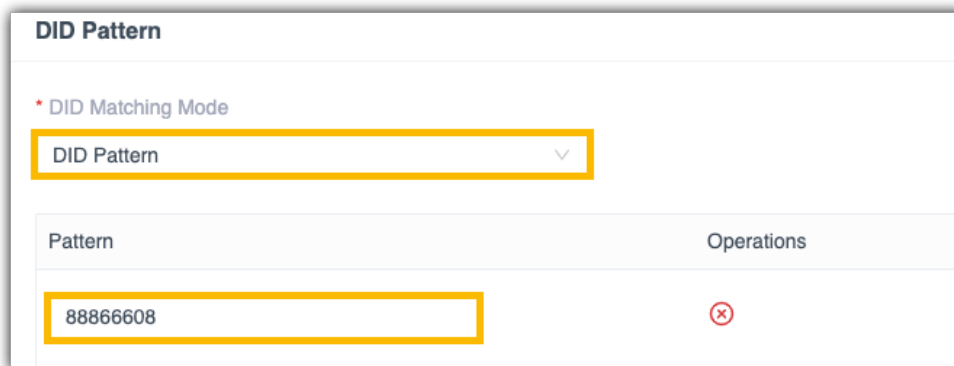

Pattern	Operations
88866608	

- **Caller ID Pattern:** Leave it blank, which means no limit of inbound caller ID.
- **Trunk:** Select the trunk that binds the DID numbers.
- **Default Destination:** Decide whether to route inbound calls to different destinations based on time and configure the destinations.

In this example, route inbound calls to the default destination whenever the calls reach the system.

- # **Default Destination:** Select the destination to the queue of sales team.

Time Condition: Unselected.

Default Destination

Default Destination *

Queue | 6404-Sales

Time Condition

- **Fax Detection:** Leave the settings as default.

Inbound Route for support team

- **Name:** Enter a name to help you identify it.
- **DID Pattern:**
 - # **DID Matching Mode:** Select **DID Pattern**.
 - # **DID Patterns:** Click **Add** and enter a DID pattern or a DID number.

In this scenario, enter *88866609*.

DID Pattern

* DID Matching Mode

DID Pattern

Pattern	Operations
88866609	⊗

- **Caller ID Match Patterns:** Leave it blank, which means no limit of inbound caller ID.
- **Trunk:** Select the trunk that binds the DID numbers.
- **Default Destination:** Decide whether to route inbound calls to different destinations based on time and configure the destinations.

In this example, route inbound calls to the default destination whenever the calls reach the system.

- # **Default Destination:** Select the destination to the queue of support team.
- # **Time Condition:** Unselected.

- **Fax Detection:** Leave the settings as default.

Result

External users will reach different teams according to the DID numbers they dial.

Route Inbound Calls based on Caller ID

Caller ID routing connects external callers with the appropriate party quickly. This topic gives a configuration example to describe how to route calls by [a caller-ID-based inbound route](#).

Scenarios

Company ABC is a Chinese company that provides consulting services around multiple cities.

For better customer experience, the company has a countrywide toll-free number 400-661-8815 and has multiple teams to provide professional services for customers from different regions.

For example, the following two teams will handle inbound calls based on different caller IDs.

Table 25.

Team	Responsible Region	Area Code
Team-A	Fujian	<ul style="list-style-type: none"> • 0591 • 0592 • 0593 • 0594 • 0595 • 0596 • 0597 • 0598 • 0599
Team-B	Guangdong	<ul style="list-style-type: none"> • 0662 • 0663 • 0668 • 0660

Configuration Example

Set up two inbound routes to route calls to different destinations based on caller IDs.

Inbound Route for Team-A

- **Name:** Enter a name to help you identify it.
- **DID Pattern:** Leave it blank, which means no limit of DID numbers.
- **Caller ID Pattern:** Click **Add** and enter a Caller ID pattern or a full Caller ID.

In this scenario, enter `059.`, which matches all inbound caller IDs that start with digit 059. For more information of Caller ID pattern, see [DID Pattern and Caller ID Pattern](#).

Pattern	Operations
059.	⊗

- **Trunk:** Select the trunk that users will call in.
- **Default Destination:** Decide whether to route inbound calls to different destinations based on time and configure the destinations.

In this example, route inbound calls to the default destination whenever the calls reach the system.

Default Destination: Select the destination to the queue of Team-A.

Time Condition: Unselected.

Default Destination

Default Destination

Queue

6402-Team-A

Time Condition

- **Fax Detection:** Leave the settings as default.

Inbound Route for Team-B

- **Name:** Enter a name to help you identify it.
- **DID Pattern:** Leave it blank, which means no limit of DID numbers.
- **Caller ID Pattern:** Click **Add** and enter a Caller ID pattern or a full Caller ID.

In this scenario, enter `066.`, which matches all inbound Caller IDs that start with digit 066. For more information of Caller ID pattern, see [DID Pattern and Caller ID Pattern](#).

Pattern	Operations
066.	✘

- **Trunk:** Select the trunk that users will call in.

In this example, select **siptrunk**, whose phone number is 400-661-8815.

- **Default Destination:** Decide whether to route inbound calls to different destinations based on time and configure the destinations.

In this example, route inbound calls to the default destination whenever the calls reach the system.

Default Destination: Select the destination to the queue of Team-B.

Time Condition: Unselected.

Default Destination

Queue ▼ 6403-Team-B ▼

Time Condition

- **Fax Detection:** Leave the settings as default.

Result

- When users from Fujian dial the number 400-661-8815, agents in Team-A will handle the calls.
- When users from Guangdong dial the number 400-661-8815, agents in Team-B will handle the calls.

Manage Inbound Routes

After you create inbound routes, you can adjust the priority of the inbound routes. You can also edit or delete the inbound routes.

Adjust priority of inbound routes

A trunk can be selected to multiple inbound routes. When users call to a trunk that is selected in multiple inbound routes, the system will route inbound calls through the route with higher priority. You can adjust the priority of inbound routes according to your needs.

1. Log in to the PBX web interface, go to **Call Control > Inbound Route**.
2. In the Inbound Route list, click     to adjust the priority of your inbound routes.

Edit an inbound route

1. Log in to the PBX web interface, go to **Call Control > Inbound Route**.
2. Click  beside the inbound route that you want to edit.
3. Edit the inbound route.
4. Click **Save** and **Apply**.

Delete an inbound route

1. Log in to the PBX web interface, go to **Call Control > Inbound Route**.
2. Click  beside the inbound route that you want to delete.
3. On the pop-up window, click **Yes** to confirm.
4. Click **Apply**.

Export and Import Inbound Routes

The inbound routes configured on Yeastar P-Series PBX System can be exported and saved as a template. You can fill in desired inbound routes in the exported file, and import the file to PBX again. This topic describes how to export and import inbound routes.

Export inbound routes

You can export all inbound routes to a CSV file, and then make additions, removals, and changes to the file.

1. Log in to the PBX web interface, go to **Extension and Trunk > Call Control > Inbound Route**.
2. Click **Export**.

A CSV file is saved to your computer. To check and edit parameters in the CSV file, see [Inbound Route Parameters](#).

Import inbound routes

We recommend that you export inbound route data to a CSV file first, and use the file as a template to start with. In this way, you can save time and effort.

Prerequisites

Requirements of an imported file:

- **Format:** UTF-8 .CSV
- **Size:** Less than 50MB
- **File name:** Less than 127 characters
- **Import parameters:** Ensure that the import parameters meet requirements. For more information, see [Inbound Route Parameters](#).

Procedures

1. Log in to the PBX web interface, go to **Extension and Trunk > Call Control > Inbound Route**.
2. Click **Import**.
3. In the pop-up window, click **Browse**, and select your CSV file.
4. Click **Import**.

The inbound routes in the CSV file will be displayed in the **Inbound Route** list.

DID Pattern and Caller ID Pattern

This topic describes special characters that can be defined in a DID pattern or a Caller ID pattern, and provides examples to help you understand and configure the pattern.

Pattern

A **Pattern** field appears when you are configuring DID numbers or Caller IDs. The **Pattern** field allows you to enter a full number or special characters that will match specific numbers.

The following table shows descriptions of the allowed characters in the Pattern field.

Table 26.

Pattern	Description
x	Matches any digit from 0 -9.
z	Matches any digit from 1- 9.
N	Matches any digit from 2 - 9.
[###]	Matches any digit in the bracket. Example: [123] matches the numbers 1, 2, or 3.

Table 26. (continued)

Pattern	Description
	 Note: Range of numbers can be specified with a dash, example [136-8] matches the numbers 1, 3, 6, 7, or 8.
.	Matches one or more numbers. Example: 9011. matches any numbers starting with digits 9011 (excluding 9011 itself).
!	Matches none or more than one characters. Example: 9011! matches any numbers starting with 9011 (including 9011 itself).

Pattern examples

The following table gives several patterns and list examples of matched numbers and mismatched numbers.

Table 27.

Pattern	Matched Number	Mismatched Number
0591.	<ul style="list-style-type: none"> • 05910 • 0591012345 	<ul style="list-style-type: none"> • 0591 • 0592229929
+ [13-5]XZN!	<ul style="list-style-type: none"> • +4021 • +1136282882 	<ul style="list-style-type: none"> • +0136282882 • +1106282882
0591ZXXXX	<ul style="list-style-type: none"> • 059123456 • 059133456 	<ul style="list-style-type: none"> • 05912345 • 059103456

Outbound Route

Outbound Route Overview

An outbound route tells the Yeastar P-Series PBX System how to handle outbound calls based on preconfigured rules and criteria. When a user makes an outbound call, the system analyses the user's extension number and the dialed number, then routes the call through a matched outbound route.

Outbound Route matching criteria

Yeastar P-Series PBX System provides the following criteria for you to configure outbound routes.

Dial Pattern

A dial pattern matches the dialed number and reformats the dialed number before sending the number out to the carrier.

For more information of dial patterns, see [Outbound Dial Pattern](#).

Outbound Route Password

Users need to enter the PIN number before they can make calls through the outbound route.

Time Condition

A Time Condition defines when the outbound route is available.

Outbound Route priority

When a user makes an outbound call, the system compares the dialed number with the dial patterns in each outbound route (from highest to lowest priority) until a match is found.

- If the first outbound route is matched, the system will place the call through the outbound route.
- If the first outbound route is not matched, the system will check the second outbound route, and so on.

For more information, see [Adjust priority of outbound routes](#).

Set up an Outbound Route

To allow users to make outbound calls through trunks, you need to set up at least one outbound route on the Yeastar P-Series PBX System.

Background information

Yeastar P-Series PBX System has a default outbound route with dial pattern `x.` that allows users to dial any outgoing numbers. You can delete the default outbound route, then add a new one to configure settings according to your needs.

Prerequisites

- Ensure that you have set up at least one trunk for outbound calls.

Procedure





1. Log in to the PBX web interface, go to **Call Control > Outbound Route**, click **Add**.
2. In the **General** section, complete the following configurations:
 - **Name:** Enter a name to help you identify it.
 - **Outbound Caller ID:** Optional. By default, each trunk is associated with a main caller ID. When users make outbound calls through a trunk, the main caller ID is displayed on the called party's device. If this option is configured, the system will override the main caller ID with the Outbound Caller ID.

For more information of caller ID, see [Caller ID Overview](#).

Note:

- # Only configure this setting when the trunk provider supports Caller ID override, or the following errors may happen:
 - # Outbound calls failed to be established.
 - # Caller ID doesn't be overridden.

3. In the **Dial Pattern** section, configure dial rules for the outbound route.
 - a. Click **Add**.
 - b. Configure the dial pattern to match dialed numbers and reformat dialed numbers.
 - **Pattern**: Enter a pattern to match dialed numbers. Only when the dialed number is matched will the call go through this outbound route.
 - **Strip**: Optional. To strip digits from the beginning of the dialed numbers, enter a value in this field to define how many digits will be removed.
 - **Prepend**: Optional. To add digits at the beginning of the dialed number, enter the digits that you want to prepend in this field.
 - c. To add more dial patterns, repeat **step a-b**.
4. In the **Trunk** section, configure the followings:
 - a. Select one or more trunks from the **Available** box to **Selected** box.
 - b. **Optional**: If multiple trunks are selected, configure the trunk sequence.
 - **Default trunk sequence**

Click the buttons     beside the **Selected** box to specify the default trunk sequence. By default, the system always selects an idle trunk from top to bottom, and uses the trunk to call out.
 - **Rrmemory Hunt**

If the option **Rrmemory Hunt** is selected, the system will remember which trunk was used last time, and use the next idle trunk to call out.
 - c. To enhance the outbound route security, configure the **Outbound Route Password**.
 - **Disable**: No password is required to call out through this outbound route.
 - **Single PIN**: Set a single PIN. All the users need to enter the same PIN to make outbound calls through this outbound route.
5. Select which users are allowed to make calls through this outbound route.

You can select extension users with specific roles or select desired extensions or extension groups directly.

 - In the **General** section, select user roles in the drop-down list of **Role**.
 - In the **Extension/Extension Group** section, select extensions or extension groups from **Available** box to **Selected** box.
6. **Optional**: In the **Time Condition** section, select an option from **Available Time** drop-down list to specify when this outbound route is available to use.
 - **Always**: This outbound route is available at any time for allowed extension users.
 - **Based on Global Business Hours**: Set up whether to allow this route in the following time separately:

- # **Business Hours:** [Global Business Hours](#) specified in the system.
 - # **Holidays:** [Holidays](#) specified in the system.
 - # **Outside Business Hours:** The time periods that are not defined as Business Hours or Holidays)
 - **Based on Custom Business Hours:** Set up custom business hours and configure whether to allow this route in the following time:
 - # **Business Hours:** The custom business hours.
 - # **Holidays:** [Holidays](#) specified in the system.
 - # **Outside Business Hours:** The time periods that are not defined as Business Hours or Holidays)
 - **Based on Custom Time Periods:** Set up multiple time periods for this route. You can also specify whether to allow this route in the [Holidays](#).
7. Click **Save** and **Apply**.

What to do next

After you finish the outbound route configurations, you need to check and adjust the priority of your outbound routes, so that the system can match and route the call out through the proper outbound route.

For more information, see [Adjust priority of outbound routes](#).

Manage Outbound Routes

After you create outbound routes, you can adjust the priority of the outbound routes. You can also edit or delete the outbound routes.

Adjust priority of outbound routes

When a user places a call, if the dialed number matches multiple dial patterns, the outbound route with the highest priority will be used. You can adjust the priority of outbound routes to route calls through proper outbound routes.





 **Note:** The route priority is important, especially if there is some overlap. For example, the number 5503305 matches both dial patterns of `zxxxxxxx` and `x.`, the PBX will send the call through the outbound route with the highest priority.

Example:

When users dial 05503301, both of the two outbound routes match 05503301:

- Outbound Route-Long-distance call: The dial pattern is `0xxxxxxx` and uses trunk 1.
- Outbound Route-Local call: The dial pattern is `x.` and uses trunk 2.

To call 5503301 through trunk 1, you need to prioritize the outbound route of "Long-distance call"; or PBX will match the outbound route of "Local call" and route the call out using trunk 2.

1. Log in to the PBX web interface, go to **Call Control > Outbound Route**.
2. Click the buttons     to adjust the priority of your outbound routes.

 **Note:** PBX will match outbound route from top to bottom.

Edit an outbound route

1. Log in to the PBX web interface, go to **Call Control > Outbound Route**.
2. Click  beside the inbound route that you want to edit.
3. On the outbound route configuration page, edit the outbound route.
4. Click **Save** and **Apply**.

Delete an outbound route

1. Log in to the PBX web interface, go to **Call Control > Outbound Route**.
2. Click  beside the outbound route that you want to delete.
3. On the pop-up dialog box, click **Yes** to confirm.
4. Click **Apply**.

Export and Import Outbound Routes

The outbound routes configured on Yeastar P-Series PBX System can be exported and saved as a template. You can fill in desired outbound routes in the exported file, and import the file to PBX again. This topic describes how to export and import outbound routes.

Export outbound routes

You can export all outbound routes to a CSV file, and then make additions, removals, and changes to the file.

1. Log in to the PBX web interface, go to **Extension and Trunk > Call Control > Outbound Route**.
2. Click **Export**.

A CSV file is saved to your computer. To check and edit parameters in the CSV file, see [Outbound Route Parameters](#).

Import outbound routes

We recommend that you export outbound route data to a CSV file first, and use the file as a template to start with. In this way, you can save time and effort.

Prerequisites

Requirements of an imported file:

- **Format:** UTF-8 .CSV
- **Size:** Less than 50MB
- **File name:** Less than 127 characters
- **Import parameters:** Ensure that the import parameters meet requirements. For more information , see [Outbound Route Parameters](#).

Procedure

1. Log in to the PBX web interface, go to **Extension and Trunk > Call Control > Outbound Route**.
2. Click **Import**.
3. In the pop-up window, click **Browse**, and select your CSV file.
4. Click **Import**.

The outbound routes in the CSV file will be displayed in the **Outbound Route** list.

Outbound Dial Pattern

This topic describes dial pattern settings of Outbound Route.

Dial Pattern components

A dial pattern comprises **Pattern**, **Strip**, and **Prepend**.

Pattern

Required.

Defines which dialed numbers will be matched.

The Pattern field allows a full number or special characters that will match specific numbers. The following table shows descriptions of the allowed characters in the Pattern field.

Pattern	Description
x	Matches any digit from 0 -9.
z	Matches any digit from 1- 9.
N	Matches any digit from 2 - 9.
[###]	Matches any digit in the bracket. Example: [123] matches the numbers 1, 2, or 3.  Note: Range of numbers can be specified with a dash, example [136-8] matches the numbers 1, 3, 6, 7, or 8.
.	Matches one or more numbers.

Pattern	Description
	Example: 9011. matches any numbers starting with digits 9011 (excluding 9011 itself).
!	<p>Wildcard ! has different meanings for SIP extensions and FXS extensions.</p> <ul style="list-style-type: none"> • If the call is made by a SIP extension, ! matches one or more characters. Example: 9011! matches any numbers starting with 9011 (including 9011 itself). • If the call is made by an FXS extension, ! limits the digit and number that users dial. Example: 9011! only matches the dial number 9011.

Strip

Optional.

Defines how many digits will be stripped from the beginning of a dialed number when the dialed number successfully matches a **Pattern**.

Example:

If you set **Pattern** as 9. and set **Strip** as 1.

If a user wants to call number 1588902923, he/she should dial 91588902923. The PBX will strip digit 9 from the dialed number, and call the number 1588902923.

Note:

- The system strips leading digits before sending the number to the carrier.
- If both **Strip** and **Prepend** are configured, the system first strips leading digits from the dialed number then prepends digits to the dialed number.

Prepend

Optional.

Defines which digits will be added at the beginning of a dialed number when the dialed number successfully matches a **Pattern**.

Example:

If a trunk requires 10-digit dialing, but users are more comfortable with 7-digit dialing, you can prepend a 3-digit area code to all 7-digit phone numbers before the calls are placed.

Note:

- The system prepends the digits before sending the number to the carrier.
- If both **Strip** and **Prepend** are configured, the system first strips leading digits from the dialed number then prepends digits to the dialed number.

Prefix and Dial Pattern

A prefix is the digit that will be removed from the dialed number before sending to the carrier.

Scenarios

Prefix setting appears when you are configuring the following settings:

- Mobile phone number for notification contacts.

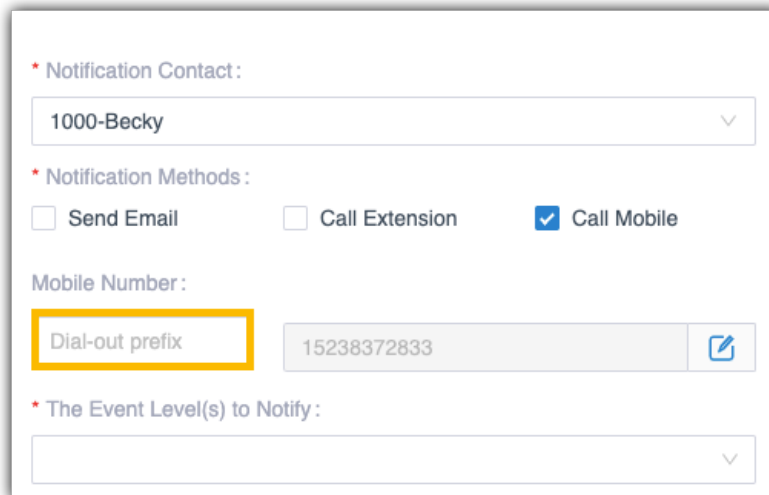

* Notification Contact:

1000-Becky

* Notification Methods:

Send Email Call Extension Call Mobile

Mobile Number:

Dial-out prefix 15238372833

* The Event Level(s) to Notify:

- External number for IVR keypress.

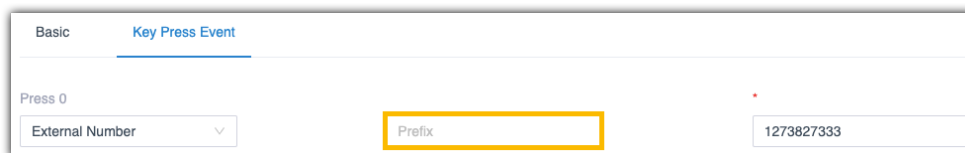

Basic Key Press Event

Press 0

External Number Prefix 1273827333

How to configure Prefix

You need to configure prefix according to the dial pattern settings on your outbound route. If the prefix is not configured correctly, the PBX cannot call to the external number successfully.

- **Leave Prefix setting blank**

If the **Strip** of outbound route is not set, you don't have to add a prefix before the phone number.

As the following figure shows, only the destination number that starts with digit *1* can be called out through this outbound route.

For example, to call number 125451, you should dial the number 125451 directly.

Pattern	Strip	Prepend
1.		

- **Add prefix before a number**

If **Strip** is set on an outbound route, you need to set the prefix according to the **Pattern**.

As the following figure shows, to make calls through the outbound route, you need to add prefix *9* before the number, and the destination number should start with digit *1*.

For example, to call number 125451, you should add prefix *9* before the number 125451.

Pattern	Strip	Prepend
91.	1	

Dial Pattern Examples

This topic provides sample dial patterns to help you understand dial patterns of outbound route.

Local calls

In Xiamen, China, local numbers are all 7-digit numbers and the numbers do not start with 0, such as 5503305.

For the local calls, set dial pattern as the following table shows.

Pattern	Strip	Prepend
zxxxxxxx	Leave it blank.	Leave it blank.

Long distance calls

In Xiamen, China, users need to dial 4-digit area code and 7-digit local number to make a long distance call, such as 0595-7588123.

- Area code format: 0ZXX, the first digit is 0, and the second digit cannot be 0.
- Local number format: 7-digit number that does not start with 0.

For the long distance calls, set dial pattern as the following table shows.

Pattern	Strip	Prepend
0ZXXZXXXXXX	Leave it blank.	Leave it blank.

Mobile calls

All mobile phone numbers in China are 11-digit numbers and start with digit 1, such as 15880260666.

For mobile calls, set dial pattern as the following table shows.

Pattern	Strip	Prepend
1XXXXXXXXXX	Leave it blank.	Leave it blank.

International calls

All international numbers start with digits 00.

For international calls, set dial pattern as the following table shows.

Pattern	Strip	Prepend
00.	Leave it blank.	Leave it blank.

DID Number

DID Number Overview

This topic describes what is DID number and DID usages on Yeastar P-Series PBX System.

What is a DID number?

Direct Inward Dialling (DID), also called Direct Dial-in (DDI), is a service offered by telephone companies. A telephone company usually assigns a range of numbers to a trunk.

There is an extra charge for the DID numbers, you need to contact the trunk provider to purchase DID numbers. The following types of trunks support DID numbers:

- SIP
- BRI
- E1/T1/J1

 **Note:** FXO trunk and GSM/UMTS/LTE trunk have no DID numbers.

DID usages

Yeastar P-Series PBX System allows you to configure DID numbers on an inbound route or a trunk to achieve different functions.

DID configuration on an inbound route

- A company can use DID numbers to identify incoming calls of different purposes, such as incoming calls for customer service, sales, etc.
- DID numbers can also be assigned to individual employees. In this way, callers can dial directly into extension users on the Yeastar P-Series PBX System.

For more information, see [Route Inbound Calls based on DID Numbers](#).

DID configuration on a trunk

- **For SIP Register Trunk**

For a SIP Register Trunk, if ITSP provides DID numbers that are different from SIP authentication name, you need to add the provided DID numbers on the trunk, or inbound calls through this trunk would fail.

- **Identify inbound calls**

To identify which DID number is dialed, you can bind each DID number with a DID name.

For more information, see [Configure DID Numbers on a Trunk](#).

Configure DID Numbers on a Trunk

This topic describes when and how to configure DID numbers on a trunk.

Background information

DID numbers are usually configured on inbound routes to distinguish inbound calls. For more information, see [Route Inbound Calls based on DID Numbers](#).

In the following scenarios, you need to configure DID numbers on a trunk:

- **For SIP Register Trunk**

For a SIP Register Trunk, if ITSP provides DID numbers that are different from SIP authentication name, you need to add the provided DID numbers on the trunk, or inbound calls through this trunk would fail.

- **Identify inbound calls**

To identify which DID number is dialed, you can bind each DID number with a DID name.

Prerequisites

- Purchase DID numbers from the trunk provider.

 **Note:** DID number is only supported on SIP trunk, BRI trunk, and E1/T1/J1 trunk.

Add a DID number

1. Log in to the PBX web interface, go to **Extension and Trunk > Trunk**, edit the desired trunk.
2. Click **DIDs/DDIs** tab.
3. In the pop-up window, configure the DID.
 - **DID/DDI:** Enter the provided DID number.
 - **DID/DDI Name:** Bind a name with the DID number.

When the DID number is dialed, the name will be displayed on the called party's device.

4. Click **Save** and **Apply**.

Import DID numbers

Prerequisites

Before you start to import DID numbers, prepare a file that meet the following requirements:

- **File format:** CSV file with UTF-8 encoding.
- **Import parameters:** The parameters meet the requirement described in XXXX.

Procedure

1. Log in to the PBX web interface, go to **Extension and Trunk > Trunk**, edit the desired trunk.
2. Click **DIDs/DDIs** tab.
3. Click **Import**.
4. In the pop-up window, click **Browse** to upload your file.

i Tip: You can click **Download the Template** to get a template file, and edit your parameters in the template file.

5. Click **Import**.

Export DID numbers

1. Log in to the PBX web interface, go to **Extension and Trunk > Trunk**, edit the desired trunk.
2. Click **DIDs/DDIs** tab.
3. On the **DIDs/DDIs** page, click **Export**.

The DID numbers are exported to a CSV file.

Delete DID numbers

1. Log in to the PBX web interface, go to **Extension and Trunk > Trunk**, edit the desired trunk.
2. Click **DIDs/DDIs** tab.
3. On the **DIDs/DDIs** page, click  to delete a DID number.
4. To bulk delete DID numbers, select the checkboxes of DID numbers, click **Delete**.
5. Click **Save**.

Caller ID

Caller ID Overview

This topic describes what is caller ID, differences between all the types of caller ID defined in Yeastar P-Series PBX System.

What is Caller ID?

Caller ID is a telephone service that transmits a caller's telephone number and name to the called party's device when a call is established.

Caller ID types

Yeastar P-Series PBX System supports the following types of Caller ID:

Outbound caller ID

Outbound caller ID is the phone number that will be displayed on the called party's phone when an extension user makes an outbound call. Each trunk has a main number, the number appears when an outbound call is received by a recipient.

To customize the outbound caller ID, you need to purchase the service from the trunk provider, and set the custom outbound caller ID on the PBX. In Yeastar P-Series PBX System, you can configure outbound caller ID based on the following features:

- Emergency Numbers
- Outbound Route
- Trunk
- Extension

For more information, see [Customize Outbound Caller IDs](#).

Inbound caller ID

Inbound caller ID is an external user's phone number that will be displayed on an extension user's phone when the external user calls in Yeastar P-Series PBX System.

Inbound Caller IDs can be reformatted before they are sent to the destination users. For more information, see [Reformat Inbound Caller ID based on a Trunk](#).

Priority of outbound caller ID

When an extension user makes an outbound call, the system first identifies if the call is an emergency call, then sends an outbound caller ID by the following priority (from the highest to the lowest).

1. Extensions' emergency outbound caller ID
2. Trunk's emergency outbound caller ID
3. Outbound Route caller ID
4. Trunk's outbound caller IDs that are associated with extension users
5. Trunk's general outbound caller ID
6. Trunk's default phone number that is provided by the carrier
7. Extension's caller ID

Reformat Inbound Caller ID based on a Trunk

This topic describes how to reformat inbound caller ID and gives configuration examples to help you understand the reformatting rule.

Background information

If an inbound caller ID is in the format that is inconvenient for users to redial directly, you can reformat the inbound caller ID.

Reformatting inbound caller ID is supported on all types of trunk. Based on different trunk providers, you may need to set up different rules to reformat inbound caller IDs.

Add a rule to reformat inbound Caller ID

1. Log in to the PBX web interface, go to **Extension and Trunk > Trunk**, edit the desired trunk.
 2. Click **Inbound Caller ID Reformatting** tab.
 3. On the **Inbound Caller ID Reformatting** page, click **Add**.
 4. In the pop-up window, configure the reformatting rule:
 - **Patterns:** Specify which Caller IDs will be reformatted. The inbound caller ID that matches this pattern will be reformatted.
 - **Strip:** Specify how many digits will be stripped from the beginning of the inbound caller ID.
 - **Prepend:** Specify the digits that will be prepended to the inbound caller ID.
-  **Note:** If both **Strip** and **Prepend** are configured, the system will first strip the leading digits then add the prepend digits to the inbound caller ID.
5. Click **Save** and **Apply**.

Example 1

Company A wants to add a digit 0 to the 11-digit inbound caller ID number that begins with digit 1 for quick redial purpose.

For example, company A wants to display 012345678910 instead of 12345678910.

In this case, you can configure the reformatting rule as below:

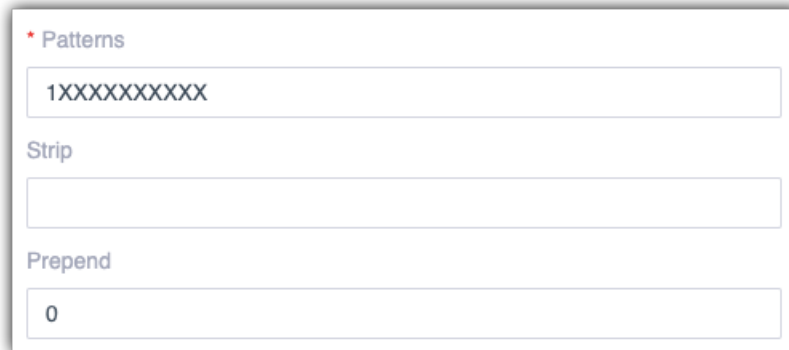

* Patterns

1XXXXXXXXXX

Strip

Prepend

0

- **Patterns:** 1XXXXXXXXXX
- **Strip:** Leave it blank.
- **Prepend:** 0

Example 2

Company B wants all local numbers to be displayed without area code (0592).

For example, company B wants to display number 5503301 instead of 05925503301.

In this case, you can configure the reformatting rule as below:

* Patterns

0592XXXXXXXX

Strip

4

Prepend

- **Patterns:** 0592XXXXXXXX
- **Strip:** 4
- **Prepend:** Leave it blank.

Customize Outbound Caller IDs

This topic describes different ways to customize outbound caller IDs, which help customers recognize who's calling.

Background information

Before you start to customize outbound caller IDs, you may need to know the following concepts:

- [Caller ID types](#)
- [Priority of outbound caller ID](#)

Prerequisites

- Customizing outbound caller ID should be supported by the trunk provider.

Customize outbound caller ID for a trunk

1. Log in to the PBX web interface, go to **Extension and Trunk**, edit the desired trunk.
2. Click **Outbound Caller ID** tab.
3. In the **General** section, configure a general **Outbound Caller ID** and **Outbound Caller ID Name** for the trunk.
4. Click **Save** and **Apply**.

The general outbound caller ID and caller ID name will be displayed on the called party's device when users make outbound calls through this trunk.

Customize outbound caller IDs for extensions

You can set up an outbound caller ID for a specific extension based on a trunk, so that an associated caller ID is sent out when the user calls out.

1. Log in to the PBX web interface, go to **Extension and Trunk**, edit the desired trunk.
2. Click **Outbound Caller ID** tab.
3. In the **Outbound Caller ID List** section, click **Add**, and configure outbound caller IDs for extensions by different methods.
4. To associate one outbound caller ID with multiple extensions, select **Shared Outbound Caller ID** and configure the following settings:
 - **Outbound Caller ID**
 - **Outbound Caller ID Name**
 - **Associated Extensions**
5. To bind consecutive outbound caller IDs to consecutive extensions with one-to-one correspondence, select **Outbound Caller ID Range** and configure the following settings:
 - **Outbound Caller ID Range**
 - **Extension Range**
 - **Outbound Caller ID Name**
6. Click **Save** and **Apply**.

When extension users make outbound calls through the configured trunk, the associated outbound caller IDs will be displayed on the called party's device.

Customize outbound caller IDs based on dialed numbers

When calling to multiple areas, you may need to display pre-defined local number for the area code you are dialling. In this case, you can configure outbound caller IDs based on the dialed numbers.

The following instruction describes how to display a custom outbound caller ID 05925503301 when users call to local numbers that have area code 0592.

1. Log in to the PBX web interface, go to **Call Control > Outbound Route**, edit the outbound route that is for local calls with area code 0592.
2. In the **General** section, enter the custom caller ID in the **Outbound Caller ID** field.

General

* Name Outbound Caller ID

Role

Dial Pattern

Dial Matching Settings

Pattern	Strip	Prepend
<input type="text" value="0592XXXXXXX"/>	<input type="text" value=""/>	<input type="text" value=""/>

3. Click **Save** and **Apply**.

Call Center

Call Center Overview

This topic describes what is Yeastar Call Center service, highlight, and the steps to set up a Call Center.

Prerequisites

Yeastar Call Center is a service that is only available on Yeastar Enterprise Plan and Ultimate Plan.

What is Yeastar Call Center service

Yeastar P-Series PBX System introduces an inbound call center solution to improve agent efficiency, responsiveness, and ultimate customer satisfaction for SMEs running service centers.

Yeastar Call Center provides a powerful console for manager and agents to handle [queue](#) calls. Call Center Console is a web-based utility integrated with Linkus Web Client, including a customizable Wallboard for proactive tracking of 16 key performance metrics, and a switchboard-type Queue Panel for real-time monitoring & control of queue activities.

For more information of monitoring queue performance and managing queue calls on Call Center Console, see [Yeastar Call Center Console User Guide](#).

Highlight

- **Real-time metrics on Wallboard:** Displays a range of call center metrics and KPIs that allow queue managers to monitor and optimize performance, and spot emerging trends in a central location.
- **Switchboard-type Queue Panel:** Show the call metrics and agents' performance in real time, and offer a comprehensive view on activity of call that allows manager and agents to handle queue calls.
- **SLA for performance measurement:** Consistent delivering service that meet or exceed the expectations set out in the SLA.
- **Insightful Call Center reports:** Real-time and historical reports that help the system administrator to track queue performance indicators, and assess agent performance.

Steps to set up Call Center

1. [Create a queue](#).
2. Set up Call Center.
 - a. **Manage queue managers:** Set one or more extension users as queue managers.

The queue managers can receive queue notifications by email.

- b. **Customize queue notification:** Send email notifications to queue manager when a queue call is missed or abandoned, or the service level agreement reaches the alarm threshold.
 - c. **Grant queue panel permissions:** Grant the permissions respectively for queue manager and agents.
 - d. **Set up Service Level Agreement (SLA):** Define a certain level of service for a queue.
3. **Manage Call Center report:** View and schedule Call Center reports.

Call Center Setup

Set up Queue Managers

With call center service activated, you can set any extension as queue manager. A queue manager does not need to be a queue agent. This topic describes how to set queue managers.

Procedure

1. Log in to the PBX web interface, go to **Call Features > Queue**, edit the desired queue.
2. Click **Members** tab.
3. In the **Queue Managers** section, manage the queue managers:
 - **To add queue managers:** Select the desired extensions from the **Available** box to the **Selected** box.
 - **To delete queue managers:** Select the desired extensions from the **Selected** box to the **Available** box.
4. Click **Save** and **Apply**.

Customize Queue Notification

With call center service activated, the system sends email notifications to queue managers when a queue call is missed or abandoned, or when the service level agreement reaches the alarm threshold. This topic describes how to customize these notifications.

Prerequisites

- Make sure there is a valid email address assigned to queue manager's extension.
- Make sure [system email](#) works.

Procedure

1. Log in to the PBX web interface, go to **Call Features > Queue**, edit the desired queue.
2. Click **Members** tab.
3. Select the checkbox of notification option according your need.
 - **Notify Manager when a queue call is missed:** Send an email to manager when a queue call is missed.
 - **Notify Manager when a queue call is abandoned:** Send an email to manager when a queue call is abandoned.
 - **Notify Manager when the SLA is lower than its alarm threshold:** Send an email to manager when the SLA alarm threshold is reached.
4. Click **Save** and **Apply**.

Grant Queue Panel Permissions

With call center service activated, you can decide what the queue managers and agents can do on Queue Panel, and grant the Queue Panel permissions for queue manager and agents respectively. This topic describes how to grant permissions for queue manager and agents.

Queue Panel permissions

Permission	Manager	Agents
Switch Agents' Status	#	×
Call monitor operations (Listen, Whisper, Barge In)	#	×
Switch agent's recording status	#	×
Call distribution management (Redirect, Transfer, Drag and Drop operation)	#	#
Allow for picking up or hanging up agents' calls	#	#
Call parking operation	#	#

Grant permissions for queue managers

1. Log in to the PBX web interface, go to **Call Features > Queue**, edit the desired queue.
2. Click **Queue Panel Permissions** tab.
3. In the **Manager** section, select the checkboxes of permissions according to your needs.
4. Click **Save** and **Apply**.

Grant permissions for agents

1. Log in to the PBX web interface, go to **Call Features > Queue**, edit the desired queue.
2. Click **Queue Panel Permissions** tab.
3. In the **Agents** section, select the checkboxes of permissions according to your needs.
4. Click **Save** and **Apply**.

Set up Service Level Agreement (SLA)

With call center service activated, you can set up service level agreement for a queue. This topic describes what is service level agreement and how to set up service level agreement.

What is Service Level Agreement (SLA)

Service Level Agreement is a call center performance statistic. It is the goal for how quickly the agent should answer a portion of the customers, and makes sure everyone is working to the same objectives.

SLA is expressed as the percentage of conversations answered within a predefined amount of time. Let us suppose that the goal is to answer 80% of calls within 20 seconds. If the measurement is less than 80%, the manager knows they are outside their target Service Level.

The calculated formula shows as below:

$$\text{SLA} = \frac{\text{total calls} - (\text{calls answered after SLA time} + \text{calls abandoned after SLA time})}{\text{total calls}} \times 100\%$$

How to set up Service Level Agreement

You can set a target service level and SLA threshold for each queue, and evaluate the service level periodically.

1. Log in to PBX web interface, go to **Call Features > Queue**, edit the desired queue.
2. Click **Preferences** tab.
3. In the **Service Level Agreement** section, edit the SLA according to your needs.
 - **SLA Time(s)**: Enter the maximum amount of time (in seconds) that an agent needs to answer an incoming call.
If a caller waits for a duration of time shorter than the SLA Time, the SLA is met.
 - **Evaluation Interval(min)**: Enter the time interval to compare the queue's SLA performance against the alarm threshold so that the system can send a notification email timely.
 - **Alarm Threshold(%)**: Enter the service level threshold for the queue.
4. Click **Save** and **Apply**.

Call Center Report

Call Center Reports Overview

Yeastar P-Series PBX System provides a set of predefined reports concerning detailed information about call center performance. This topic describes what you can do with call center report, and the report types.

What you can do with call center reports

The system automatically generates reports in the format of graphs or charts, and helps you to simplify analysis and extract invaluable data with ease. These reports can be historical and real-time. You can view and schedule reports on demand to evaluate past activities and plan future actions.

Reports types

We divide reports into two categories: queue performance and agent performance.

- **Queue performance reports:** The queue performance reports give you insight into the work efficiency of one or more queues over a period of time, and help you evaluate the performance of each queue.
 - # **Queue Performance**
 - # **Queue AVG Waiting & Talking Time**
 - # **Satisfaction Survey Report**
- **Agent performance reports:** The agent performance reports give you insight into the performance of one or more agents, and help you evaluate if every agent meets the expectations of your call center over a period of time.
 - # **Agent Login Activity**
 - # **Agent Pause Activity**
 - # **Agent Missed Call Activity**
 - # **Agent Call Summary**

Queue Performance reports

'Queue Performance' Report

Queue Performance provides information about how calls are handled by queues. This topic describes the report details, and shows you a report example.

Report details

The following table lists the related parameters for Queue Performance report.

Parameter	Description
Total Calls	The total number of calls that queue received.
Answered	The total number of calls that queue answered.
Missed	The total number of calls that queue missed.
Abandoned	The total number of calls that callers abandoned before connecting to an agent.
Max Waiting Time	The longest time a caller waited in the queue before an agent answered the call.
Average Waiting Time	The average amount of time that it takes for an incoming call to be distributed to an agent.
Answered Rate	The percentage of answered calls in relation to the total received calls.
Missed Rate	The percentage of missed calls in relation to the total received calls.
Abandoned Rate	The percentage of abandoned calls in relation to the total received calls.
SLA	The Service Level Agreement (SLA) for the queue. SLA is the percentage of conversations answered within a predefined amount of time.

Report example

The following report shows the performance of the Service department in the past 30 days. Calls abandoned within 10 seconds are not included in the report.

Report Type: Queue Performan... | Time: 08/26/2020 00:00:00 ~ 09/24/2020 23:59:59 | * Queue: 6400-Service x | Short Abandoned Calls: 10

[Refresh](#)

Queue	Total Calls	Answered	Missed	Abandoned	Average Waiting Time	Max Wait Time	Answered Rate	Missed Rate	Abandon Rate	SLA
Service	20	13	4	3	00:00:17	00:01:42	65%	20%	15%	55%
Total	20	13	4	3						

'Queue AVG Waiting & Talking Time' Report

Queue AVG Waiting & Talking Time report provides information about the average amount of time that callers are waiting in a queue, and the average amount of time that an agent spends in handling calls. The report helps you to identify the peak times of queue calls, and allocate your agent accordingly. This topic describes the report details, and shows you a report example.

Report details

The Queue AVG Waiting & Talking Time includes a graph and a table that shows the following information for each queue:

Parameter	Description
Average Waiting Time	The average amount of time that it takes for an incoming call to be distributed to an agent.
Average Talking Time	The average amount of time that a caller talks to an agent.

Report example

The following report shows the daily average waiting & talking time of Service department during 09/2020.

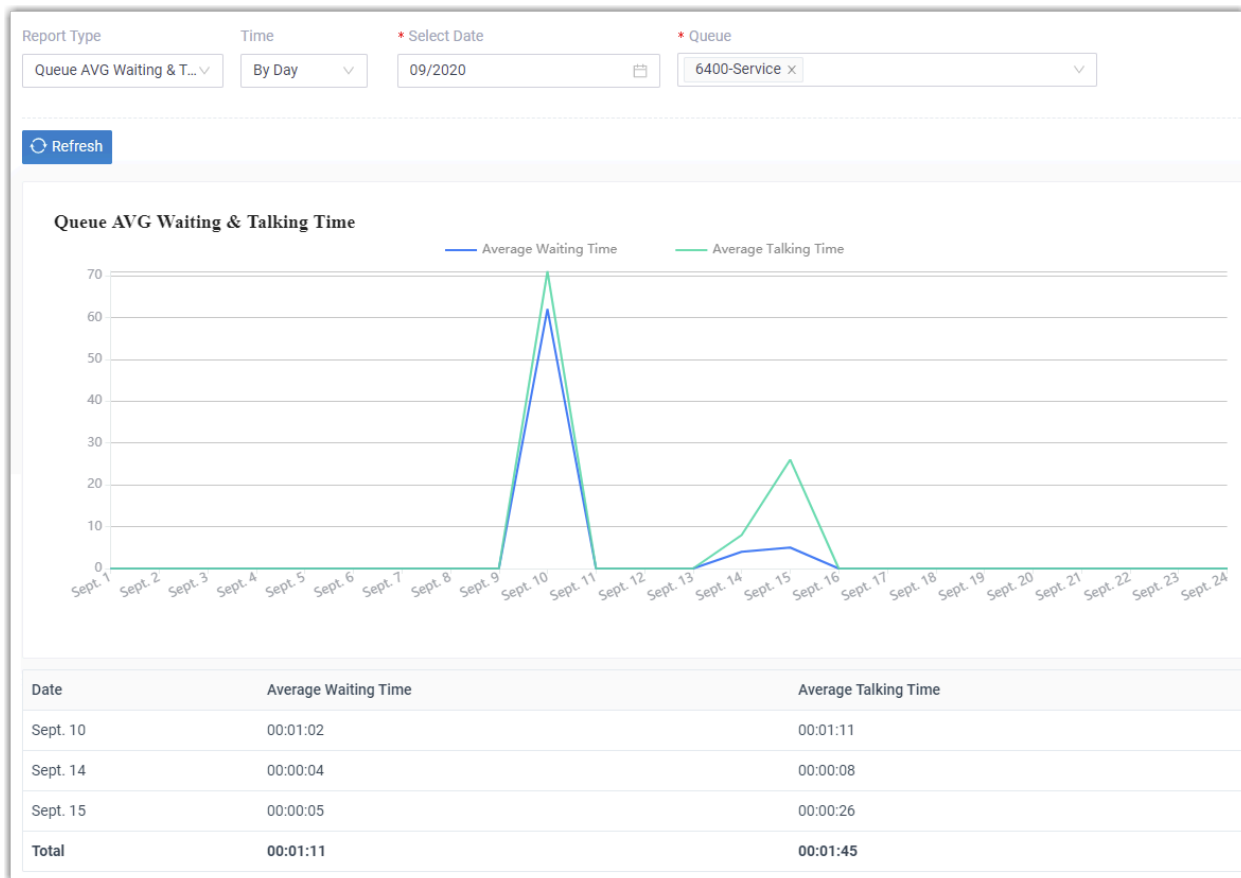

'Satisfaction Survey' Report

Satisfaction Survey report provides statistic about the key pressed collected from callers. The report helps you measure customer satisfaction and improve service. This topic describes the report details, and shows you a report example.

Report details

After the agent hangs up a call, the system plays a pre-defined prompt to ask callers to rate their satisfaction scale. For example, "Please rate your satisfaction with our service, press 1 for satisfied, press 2 for dissatisfied. Thank you.". The Satisfaction Survey report displays how many times that a key is pressed by callers.

Report example

The following report shows the satisfaction survey of Service department and its agents in the last 7 days.

Queue	KEY:1	KEY:2	KEY:4
6400-Service	4	2	1
3333-Sunny Yeah	1	1	0
3334-John Snow	3	1	1

Agent Performance Report

'Agent Login Activity' Report

Agent Login Activity report provides information about the login and logout activities of each agent. The report helps you count the working hours of the agents working in shifts. This topic describes the report details, and shows you a report example.

Report details

The Agent Login Activity includes a table that shows the following information for each agent:

Parameter	Description
Logged in	The date and time that an agent logged in to a queue.
Logged out	The date and time that an agent logged out of a queue.
Total Login Time	The elapsed time between the login time and the logout time.

Report example

The following report shows the login activities of all agents in Service department in the past 7 days.

Agent	Logged In	Logged Out	Total Login Time
1000-Becky	09/21/2020 10:54:20	09/21/2020 10:58:36	00:04:16
	09/21/2020 11:01:39	09/21/2020 11:02:22	00:00:43
Total			00:04:59
3333-Sunny Yeah	09/21/2020 10:54:24	09/21/2020 10:58:49	00:04:25
Total			00:04:25
3334-John Snow	09/21/2020 10:54:27	09/21/2020 11:01:29	00:07:02
	09/21/2020 11:02:11	09/21/2020 11:02:56	00:00:45
Total			00:07:47
3335-Jim	09/21/2020 10:54:29	09/21/2020 11:01:32	00:07:03
	09/21/2020 11:02:13	09/21/2020 11:02:58	00:00:45
Total			00:07:48

'Agent Pause Activity' Report

Agent Pause Activity provides information about the pause and unpause activities of each agent. The report helps you count the pause time of each agents. This topic describes the report details, and shows you a report example.

Report details

The Agent Pause Activity shows the following information for each agent:

Parameter	Description
Pause	The date and time that an agent changed status to pause.
Unpause	The date and time that the agent changed status to unpause.
Total Pause Time	The elapsed time between the paused time and the unpaused time.

Report example

The following report shows the pause activities of all agents in Service department in the past 7 days.

Report Type	Time	Queue	Agent
Agent Pause Activity	09/14/2020 00:00:00 ~ 09/21/2020 23:59:59	6400-Service	
Refresh			
Agent	Pause	Unpause	Total Pause Time
3333-Sunny Yeah	09/14/2020 15:16:03	09/14/2020 15:16:31	00:00:28
Total			00:00:28
3334-John Snow	09/21/2020 10:55:06	09/21/2020 10:58:28	00:03:22
Total			00:03:22
1000-Becky	09/21/2020 10:55:04	09/21/2020 10:58:33	00:03:29
Total			00:03:29
3335-Jim	09/21/2020 10:55:09	09/21/2020 10:58:40	00:03:31
Total			00:03:31

'Agent Missed Call Activity' Report

Agent Missed Call Activity report provides the missed call information for each agent. The report helps you assess an agent's efficiency. This topic describes the report details, and shows you a report example.

Report details

Parameter	Description
Time	The date and time that an agent missed a call.
Waiting Time	The amount of time that the caller waited for the assigned agent to answer the call.
Call From	The caller's caller ID.
Agent Status	The final status of missed calls, indicating whether the missed calls were answered by other agents.
Polling Attempts	The number of polling attempts to call an agent.

Report example

The following report shows the missed call activities of all agents in Service department in the past 30 days. Calls abandoned within 10 seconds are not included in the report.

Report Type	Time	Queue	Agent	Short Abandoned Calls	
Agent Missed Cal... ▾	08/26/2020 00:00:00 ~ 09/24/2020 23:59:59 📅	6400-Service ▾	▾	10	
Refresh					
Agent	Time	Waiting Time	Call From	Agent Status	Polling Attempts
3333-Summy Yeah	09/10/2020 17:16:31	00:02:28	3337	NO ANSWER	5
	09/10/2020 17:31:44	00:00:30	4444	NO ANSWER	1
Total		00:02:58			6
3334-John Snow	09/10/2020 17:45:07	00:00:10	3337	NO ANSWER	1
Total		00:00:10			1

'Agent Call Summary' Report

Agent Call Summary provides information about the number of incoming and outgoing calls that were received and placed by each agent. This topic describes the report details, and shows you a report example.

Report details

Parameter	Description
Inbound	The number of incoming calls received by an agent.
Outbound	The number of outgoing calls placed by an agent.
Talk Duration	The amount of time an agent spent in incoming calls or outgoing calls.
Total calls	The total number of incoming calls and outgoing calls handled by an agent.
Total Talk Duration	The total amount of time an agent spent in incoming calls and outgoing calls.

Report example

The following report shows the call summary of all agents in Service department in the last 30 days.

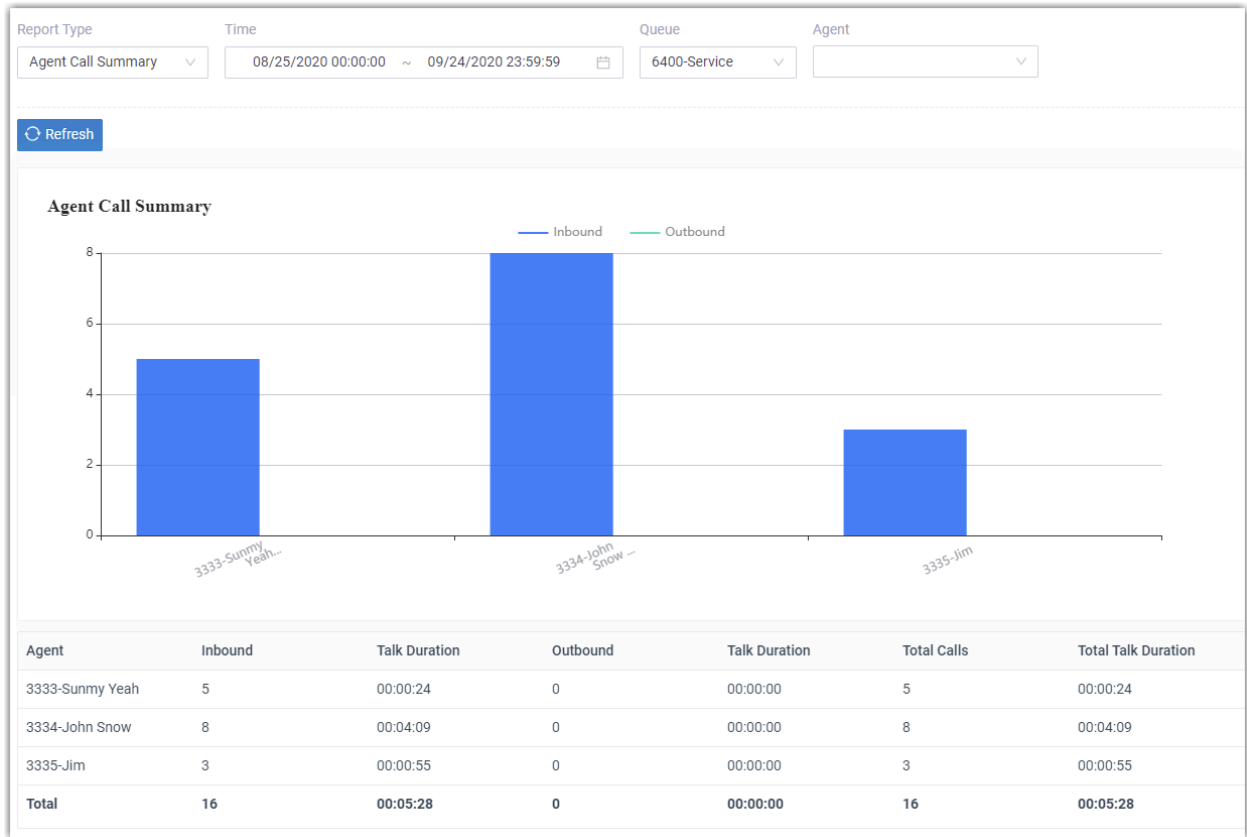

Call Features

Voicemail

Voicemail Overview

PBX integrates a free voicemail system. This topic describes the usage of voicemail, voicemail personalization, and the adjustable voicemail capacity and limitations.

Voicemail usage

A flexible call route system for forwarding calls to voicemail:

- **Extension:** Allow the caller to leave a message when the extension user is unavailable to take a call.
- **Ring Group/Queue:** Failover to voicemail if no agents are available or timeout is reached.
- **IVR:** Give the customers an option to leave a voicemail message. When the customers cannot get the information from IVR, they can leave a message.
- **Any inbound calls:** Provide a dedicated line to collect user feedback if immediate phone support is not required.

Voicemail personalization

Various options are available for personalizing voicemail:

- **Voicemail greeting:** Custom greeting is available for global or a specific extension. The extension users can also customize their greeting based on presence.
- **Voicemail notification:** Various ways to get notified of new voicemail messages, including on IP phones, emails, or Linkus clients.
- **Envelope playback:** Play optional envelope information before listening to voicemail message, including date and time, caller ID, and message duration.
- **Caller experience:** User-friendly experience in leaving a message, such as allow the caller to review message, send a message without ringing extensions, break out of voicemail to operator, etc.

Adjustable Voicemail capacity and limitations

You can change the voicemail capacity and limitations for each extension.

- Length for a message: 1 to 15 minutes.
- Mailbox capacity: 1 to 500.

- Storage time: Unlimited time.

Send and Receive Voicemail Messages

Forward Calls to Voicemail

Never miss a lead by allowing your customers to leave voicemail messages. This topic describes how to forward various kinds of calls to voicemail.

Background information

A growing business cannot afford to miss incoming calls. A missed call may make your customers impatient. Forwarding calls to voicemail automatically helps you to stay connected with customers and enhance the service.

In the following scenarios, you can consider a destination as voicemail, which helps the system to forward calls to voicemail:

- **For extension users:** The extension user is unavailable to answer a call.
- **For Ring Group/Queue:** No agents are available to take a call or the call reaches the timeout.
- **For IVR:** Give the customers an option to leave a voicemail message. When the customers cannot get the information from IVR, they can leave a message.
- **For inbound calls:** Immediate phone support is not required.

Forward extension users' calls to voicemail

You can set call forwarding rules for each presence status as users need, the system will forward extension users' calls to voicemail according to the presence.

1. Log in to the PBX web interface, go to **Extension and Trunk > Extension**, edit the desired extension.
2. Click **Presence** tab, select a presence status to configure.
3. In the **Call Forwarding** section, check the call conditions, and select **Voicemail**.
4. Click **Save** and **Apply**.

Set failover destination to voicemail for a ring group or queue

1. Log in to the PBX web interface, go to **Call Features > Ring Group/Queue**, edit the desired ring group or queue.
2. In the **Failover Destination** drop-down list, select **Extension Voicemail**.
3. Select an extension to receive voicemail message.
4. Click **Save** and **Apply**.

Allow users to leave voicemail messages by IVR

Prerequisites

Update your IVR prompt that would instruct callers to press a key to access voicemail.

Procedure

1. Log in to the PBX web interface, go to **Call Features > IVR**, edit the desired IVR.
2. Click **Key Press Event** tab, select **Extension Voicemail** for specific key.
3. Select an extension to receive voicemail message.
4. Click **Save** and **Apply**.

Forward inbound calls to voicemail

On non-working days, you can forward inbound calls to voicemail according to your [business hours and holiday](#).

1. Log in to the PBX web interface, go to **Call Control > Inbound Route**, edit the desired inbound route.
2. In the **Default Destination** section, select **Extension Voicemail**.
3. Select an extension to receive voicemail message.
4. Click **Save** and **Apply**.

Leave a Voicemail Message without Calling the User

This topic describes how to send a voicemail message without ringing extensions.

Background information

Although you can send a message by email or text, sometimes there is no replacement for the emotion, inflection, and sincerity of your voice. When you do not want to disturb someone or when you do not have time for a phone conversation, you can send a voicemail message without calling extension.

It is useful in a team work. When your partners are busy in a meeting or after work, but you have some information that need to share with them, you can send a voicemail message without calling them. It allows your partner to reflect prior to responding.

Prerequisites

This feature is only for internal extension users.

Procedure

1. Dial feature code (*12) followed by extension number (for example, *121001).

2. Follow the voice prompt to leave your message.
3. Hang up or press # after done.

i Tip: The default feature code for sending voicemail messages is *12. You can change, enable, or disable the code on PBX web interface: **Call Features > Feature Code > Voicemail > Leave a Voicemail for an Extension.**

Forward Voicemail Messages to Email

Email is one of the most popular communication tools for business. Forwarding voicemail messages to email is an efficient business feature that allows employees to receive voicemail audio files as email attachments. This topic describes what you can do with voicemail to email and how to forward voicemail message to email for specific extension users.

Background information

Scenario

For employees who travel frequently and require an efficient way to keep up with voicemail and provide a quick response to the customers, it is an efficient way to get alert timely, listen to voicemails anywhere, and handle business over email.

Benefit

Each time the employees receive a voicemail message, they can receive an email with the new voicemail message attached as a .wav file, including caller ID, time of the call and callback number.

- **Easy to identify:** In emails, the employees can quickly identify the person who left the message, and listen to voicemail message as they need.
- **Easy to listen:** The employees can check and listen to their voicemail messages via computer, smart phone or mobile device at convenience, instead of calling to voicemail box and navigating through the maze of voice prompts. They can also fast-forward or rewind to reach and repeat the important portion.
- **Easy to share:** The employees can forward emails to share voice messages with teammates to improve collaboration efficiency.
- **Easy to manage:** Managing the communications is easier since all the voicemail messages are in the email box. It is faster to sort, prioritize, scan, delete, and save voicemail message.

Prerequisites

- Make sure there is a valid email address assigned to each extension.

- Make sure the PBX [system email](#) works, or the PBX cannot forward the received voicemail to an extension user's email.

Procedure

1. Log in to the PBX web interface, go to **Extension and trunk > Extension**, edit the desired extension.
2. Click **Voicemail** tab.
3. In the **New Voicemail Notification** drop-down list, select **Send Email Notifications with Attachment**.
4. In the **After Notification** drop-down list, set how to handle the voicemail message after the system has successfully notified the extension user by email.
5. Click **Save** and **Apply**.

Manage Voicemail Messages

Check Voicemail Messages

This topic describes how to check voicemail messages.

Background information

Methods

There are multiple ways to check voicemail messages anytime and anywhere.

- On IP phone
- On Linkus client
- Via Email
- Via IVR

Feature code

The default feature code for checking voicemail messages is *2. You can change, enable, or disable the code on PBX web interface: **Call Features > Feature Code > Voicemail > Check Voicemail/Subscribe Voicemail Status**.

Check voicemail messages on IP phone

From your phone

1. Dial feature code *2.
2. Follow the voice prompt to enter your PIN number followed by #.
3. Navigate through the [voicemail menu](#) to check your voicemail message.

From another phone

1. Dial feature code *2 followed by your extension number (for example, *121001).
2. Follow the voice prompt to enter your PIN number followed by #.
3. Navigate through the [voicemail menu](#) to check your voicemail message.

Check voicemail messages on Linkus client

If you have enabled **Linkus Clients** for extension users, the extension users can check voicemail messages on their Linkus clients.

Check voicemail messages via Email

If you have set up the feature of [forwarding voicemail messages to email](#) for extensions, the extension users can check voicemail messages in their email box.

Check voicemail messages via IVR

If you have allowed the extension users to [dial in an IVR to check voicemail messages](#), the extension users can also check voicemail messages when out of office.

1. Dial the IVR number, follow the voice prompt.
2. Dial feature code *2 followed by extension number (for example, *121001), enter the PIN number.
3. Navigate through the [voicemail menu](#) to check voicemail message.

Configure Message Envelope

This topic describes how to enable or disable message envelope.

Background information

Message envelope is given before a voicemail message is played. Message envelope includes the following information:

- Date and Time that the message was received.
- Caller ID information.
- Duration of the message.

You can enable or disable envelope information separately as the user needs.

Procedure

1. Log in to the PBX web interface, go to **Extension and Trunk > Extension**, edit the desired extension.
2. Click **Voicemail** tab.

3. Select the checkbox of **Play Date and Time**.
4. Select the checkbox of **Play Caller ID**.
5. Select the checkbox of **Play Message Duration**.
6. Click **Save** and **Apply**.

Limit Voicemail Message Length

Limiting voicemail message length is a good way to reduce invalid or lengthy voicemails. This topic describes how to specify the message length (max and min) for a caller to leave a voicemail message.

Procedure

1. Log in to the PBX web interface, go to **Call Features > Voicemail > Message Options**.
2. In the **Max Message Time(s)** drop-down list, select a number of seconds.
Messages exceeding the maximum duration will be automatically cut off.
3. In the **Min Message Time(s)** drop-down list, select a number of seconds.
Messages less than the minimal duration will be automatically discarded.
4. Click **Save** and **Apply**.

 **Tip:** You may need to inform the callers in the greeting to keep their messages brief or under the maximum duration.

Set up a Storage Location for Voicemail Messages

The voicemail messages are stored in Yeastar P-Series PBX System by default, you can specify other storage locations for voicemail messages. This topic describes how to set up a storage location for voicemail messages.

Prerequisites

Set up a [storage device](#).

Procedure

1. Log in to the PBX web interface, go to **System > Storage > Storage Locations**.
2. In the **Voicemail** drop-down list, select a storage device.
3. Click **Save** and **Apply**.

Result

The voicemail messages are stored in the specified storage device.

Auto Cleanup Voicemail Messages

Clean up old messages to free up space for new voicemail messages. You can determine how many and how long that the system retains voicemail messages of an extension. The system automatically deletes the old voicemail messages when the threshold is reached. This topic describes how to set up auto cleanup of voicemail messages for each extension.

Procedure

1. Log in to the PBX web interface, go to **System > Storage > Auto Cleanup > Voicemail Auto Cleanup**.
2. In the **Max Number of Voicemail** field, enter the maximum number of voicemail messages that should be retained for each extension.
3. In the **Voicemail Preservation Days** field, enter the maximum number of days that voicemail messages should be retained.

 **Note:** The value 0 indicates no limit.

4. Click **Save**.

Result

If [Auto Clean up Reminder is enabled](#), and the retained voicemail messages reach 90% of the threshold, the system sends you a notification email.

Voicemail Security

Change Voicemail Access PIN

This topic describes how to change voicemail access PIN for extension users.

Background information

By default, the extension users need to enter the voicemail access PIN for authentication when checking their voicemail messages. The default voicemail access PIN is randomly generated.

There are two ways to change voicemail access PIN:

- On web interface
- Via voicemail mailbox

 **Note:** The PIN can be numerics only, and a minimum of 3 digits is required.

Change voicemail access PIN on web interface

1. Log in to the PBX web interface, go to **Extension and Trunk > Extension**, edit the desired extension.
2. Click **Voicemail** tab.
3. In the **Voicemail Access PIN** field, enter a PIN number.
4. Click **Save** and **Apply**.

Change voicemail access PIN via voicemail mailbox

1. Dial *2 to enter mailbox, enter the access PIN.
2. Press 4 to change the voicemail access PIN.
3. Follow the voice prompt, and enter the new PIN followed by # key.

The call ends automatically after saving the new PIN.

 **Important:** For security reasons, we recommend that you change the voicemail access PIN regularly.

Enable or Disable Voicemail Access PIN

A voicemail access PIN is helpful to prevent unauthorized access. This topic describes how to enable or disable voicemail access PIN for specific extension user.

 **Note:** For security reasons, we recommend that you enable voicemail access PIN for all extension users.

Procedure

1. Log in to the PBX web interface, go to **Extension and Trunk > Extensions**, edit the desired extension.
2. Click **Voicemail** tab.
3. To enable voicemail access PIN, select **Enabled** from the **Voicemail PIN Authentication** drop-down list.
4. To disable voicemail access PIN, select **Disabled** from the **Voicemail PIN Authentication** drop-down list.
5. Click **Save** and **Apply**.

 **Important:** For security reasons, we recommend that you [change the voicemail access PIN](#) periodically.

Voicemail Greetings

Voicemail Greeting Overview

Voicemail greeting is a short message that is played before a caller records a message. Via the greeting, you can inform the callers your information, like when you will be available, other methods to contact you, or other options that the caller can use to receive assistance.

Greeting types

There are two types of voicemail greetings that you can set up for extension users:

- **System Global Greeting:** A greeting that is applied to extension users who don't have personal greetings.
- **Personal Greeting:** A greeting that is personalized by extension user.

Personal greeting based on presence

The extension user can choose how to play greetings in different presence:

- **Default greeting:** Play a greeting for any presence that doesn't have a personal greeting.
- **Presence greetings:** Play a personal greeting for each presence status (available, away, do not disturb, lunch break, business trip, and off work).

For example, the extension user can choose to play one greeting when she/he changes presence to **Lunch Break** (such as, "I'm currently on a lunch and unable to take your call") and a different one when they change presence to **Away** (such as, "I'm currently away from my desk").

Record or Upload Voicemail Greetings

This topic describes how to record or upload voicemail greetings for specific extension user.

Background information

The personalized greetings can delight the callers, and let them know why you're unavailable and how they to contact you. The extension users may want to make their voicemails more personalized and professional depending on presence status, you can set personalized voicemail greetings for each user.

Up to ten individual greetings are customizable for each extension user. It is easy to customize personal greeting in two ways:

- **Upload an audio file:** Prepare an audio file in WAV.



Note: The uploaded file should meet the [audio file requirements](#).

- **Record a voicemail greeting from phone:** Place a call from system, the extension users can answer the call and record their voice as voicemail greetings.

Upload a voicemail greeting

1. Log in to the PBX web interface, go to **Extension and Trunk > Extension**, edit the desired extension.
2. Click **Voicemail** tab.
3. In the **Voicemail Greeting** section, click **Greeting Management**.
4. In the pop-up window, click **Upload**.
5. Select an audio file to upload.

You can view and manage the greeting in **Greeting Management**.

Record a voicemail greeting from phone

1. Log in to the PBX web interface, go to **Extension and Trunk > Extension**, edit the desired extension.
2. Click **Voicemail** tab.
3. In **Voicemail Greeting** section, click **Greeting Management**.
4. In the pop-up window, click **Record New Greeting** tab.
5. In the **Audio File Name** field, enter a name to help you identify it.
6. In the **Extension** drop-down list, select an extension to record a greeting.
7. Click **Save**.

The system places a call to the selected extension.

8. Answer the call, and record greeting on the phone.

Press **#** key or hang up after recording greeting, you can view and manage the greeting in **Greeting Management** tab.

Manage Personal Voicemail Greetings

This topic describes how you can manage an extension user's personal greeting, including playing, downloading, and deleting greetings.

Play a personal greeting

To check the uploaded greetings or recorded greetings, you can play the greeting on a phone or on web.

1. Log in to the PBX web interface, go to **Extension and Trunk > Extension**, edit the desired extension.
2. Click **Voicemail** tab.
3. In the **Voicemail Greeting** section, click **Greeting Management**.
4. Select a greeting that you want to play, click .
5. In the pop-up window, choose how to play the greeting:

- **Play on Web:** Click  to play the greeting on the web directly.
- **Play to Extension:** Play the greeting on a phone.
 - a. Select an extension, and click **Play**.
The system places a call to the extension.
 - b. Pick up the call to listen to the greeting on the phone.

Download a personal greeting

1. Log in to the PBX web interface, go to **Extension and Trunk > Extension**, edit the desired extension.
2. Click **Voicemail** tab.
3. In the **Voicemail Greeting** section, click **Greeting Management**.
4. Select a greeting that you want to download, click .

Delete personal greetings

1. Log in to the PBX web interface, go to **Extension and Trunk > Extension**, edit the desired extension.
2. Click **Voicemail** tab.
3. In the **Voicemail Greeting** section, click **Greeting Management**.
4. To delete a greeting, do the following:
 - a. Click  beside the greeting.
 - b. Click **OK** and **Apply**.
5. To delete greetings in bulk, do the following:
 - a. Select the checkboxes of the greetings, click **Delete**.
 - b. Click **OK** and **Apply**.

Change Voicemail Greetings

Both the global and personal voicemail greeting are changeable. This topic describes how to change voicemail greetings for specific extension user.

Change global voicemail greetings for all extensions

Prerequisites

[Upload a custom greeting](#) or [record a custom greeting](#).

Procedure

1. Log in to the PBX web interface, go to **Call Features > Voicemail > Greeting Options**.
2. In the **Global Voicemail Greeting** drop-down list, select an audio prompt.
3. Click **Save** and **Apply**.

Change voicemail greetings for a specific extension

Prerequisites

[Record or upload voicemail greeting](#) for the specific extension.

Procedure

1. Log in to the PBX web interface, go to **Extension and Trunk > Extension**, edit the desired extension.
2. Click **Voicemail** tab.
3. In the **Voicemail Greeting** section, select a greeting:

- **Default Greeting:** Select a greeting from **Default Greeting** drop-down list.

Default greeting is played when the **Presence Greetings** is set to **None**.

- **Presence Greetings (Available, Away, Do Not Disturb, Lunch Break, Business Trip, and Off Work):** Select a greeting from the corresponding presence drop-down list.

The presence greeting is played based on presence status .

 **Tip:** You can also select **Record New** to add a new greeting and apply.

4. Click **Save** and **Apply**.

Voicemail Notifications

Voicemail Notification Overview

Extension users can get an instant notification when receiving a new voicemail message. This topic describes various ways to get notified of new voicemail messages.

Notification on IP phones

There are two methods that you can use to monitor voicemail status on IP phone.

Monitor voicemail status by function keys

You can use a function key to monitor changes of voicemail status, including monitor your voicemail or other user's voicemail. It is useful when sharing a single voicemail in a team. The team members can monitor and access the voicemail in time. Once someone reads or deletes the message, no one else should have to deal with it.

Monitor voicemail status by MWI

Message Waiting Indicator (MWI) is a commonly supported phone feature that alerts you when receiving a new voicemail message. MWI typically involves a flashing light and optional audio alert. This can differ from device to device.

Notification by email

You can set up email notification for extension users. When receiving a voicemail message, users can get alert timely, read the message at a glance to see the caller and when the message is left, and listen to voicemails. This improves work efficiency.

- For employees who do not use the phone frequently, they don't need to pay attention to keep checking voicemail on the phone at all time.
- For employees who travel frequently, they can process voice messages in real time and respond to customers' promptly.

Monitor Voicemail Status on an IP Phone

This topic describes how to monitor voicemail status on an IP phone by function keys and MWI.

Monitor voicemail status by function keys

For extension users who want to monitor voicemail status on their phone, you can set a function key for each extension user by [auto provisioning](#).

 **Note:** Users can also set function keys on their own IP phones. For more information, contact the phone manufacturer.

Procedure

1. Assign function keys for extension users to monitor voicemail status.
 - a. Log in to the PBX web interface, go to **Extension and Trunk > Extension**, edit the desired extension.
 - If you want to assign function keys for a specific extension user, click  beside the desired extension.
 - If you want to assign function keys for multiple extensions, select the checkboxes of the desired extensions, and click **Edit**.
 - b. Click the **Function Keys** tab.
 - c. Configure function keys.

 **Note:** The number of programmable keys varies by phone models. If the number of function keys you assign to an extension exceeds the number of programmable keys, the redundant function keys cannot take effect.

- **Type:** Select **Check Voicemail**.

- **Value:** Select the extension that you want to monitor.
 - **Label:** Optional. Enter a value, which will be displayed on the phone screen.
- d. Click **Save**.
2. If the extension haven't be associated with a phone, see [Auto Provision IP Phones](#) to bind a phone with the extension.
 3. If the extension have been associated with a phone, reprovision the phone to take effect.
 - a. Go to **Auto Provisioning > Phones**.
 - b. Click  beside the phone assigned to this extension.

Result

The function key shows the real-time status of voicemail.

- **Green:** The monitored extension has no unread voicemail messages.
- **Red:** The monitored extension has unread voicemail messages.

To check the voicemail message, press the function key to access the voicemail box and operate following by the prompt instructions.

 **Note:** The key LED status may vary by phone models.

Set up Email Notifications for Voicemail

This topic describes how to set up email notifications for new voicemail messages.

Prerequisites

- Make sure there is a valid email address assigned to each extension user.
- Make sure the PBX [system email](#) works, or the PBX cannot send voicemail messages to an extension user's email.

Procedure

1. Log in to PBX web interface, go to **Extension and Trunk > Extension**, edit the desired extension.
2. Click **Voicemail** tab.
3. In the **New Voicemail Notification** drop-down list, select a voicemail notification method or disable email notification.
 - **Do not Send Email Notifications:** Disable email notification.
 - **Send Email Notifications without Attachment:** Send a notification email as soon as receiving a new voicemail message in mailbox.
 - **Send Email Notifications with Attachment:** Send a notification email with the new voicemail message attached as a .wav file.

 **Note:** It is easy to read the subject or .wav file name at a glance to see who called, when the message was left, and the callback number.

4. In the **After Notification** drop-down list, select a desired option from the drop-down list.

- **Do Nothing:** Keep the voicemail messages in mailbox as unread.
- **Make as Read:** Keep the voicemail messages in mailbox as read to prevent users from repeatedly receiving reminders on their phone.
- **Delete Voicemail:** Delete the voicemail message to avoid mailbox being filled up.

 **Note:** We recommend that you choose this option only when the extension user has received a notification email with voicemail message attachment.

5. Click **Save** and **Apply**.

Customer Voicemail Experience

Allow Callers to Press a Key to Leave Messages

This topic describes how to allow callers to press a key to leave messages.

Background information

By default, when the caller accesses a user's voicemail, PBX starts to record message automatically. It may make callers embarrassed when they are not ready to leave a message or they don't need to leave a message. Even if the caller hangs up directly, the voice mailbox still generates a lot of invalid information.

Procedure

1. Log in to the PBX web interface, go to **Call Features > Voicemail**.
2. In the **Caller Options** section, select the checkbox of **Allow callers to press 5 for leaving a message**.
3. Click **Save**.

Result

The caller can choose whether to leave a message after listening to the greeting, and press 5 to leave a message after he/she is ready.

Allow Callers to Dial Extension from Voicemail

This topic describes how to allow callers to dial extension from voicemail.

Background information

For the employees working in multiple places, they can record a greeting to prompt the caller to dial another extension to reach them. Instead of hanging up and calling again, you can allow the caller to dial extensions directly from voicemail.

It is also useful when the boss is unavailable to answer a call, instead of leaving a message in emergency, the caller can dial the secretary's extension, .

Procedure

1. Log in to the PBX web interface, go to **Call Features > Voicemail**.
2. In the **Caller Options** section, select the checkbox of **Allow callers to dial extension**.
3. Select the extensions that can be dialed from the **Available** box to the **Selected** box.
4. Click **Save** and **Apply**.

Allow Callers to Break out from Voicemail

This topic describes how to allow callers to break out from voicemail, and access the operator.

Background information

For technical support, doctor office or sales manager, they do need someone available in case of any emergencies after hours. When callers access the voicemail, it would be nice to allow the callers to press 0 to get to the operator directly in emergency. Otherwise, they have to hang up and redial.

Procedure

You can specify an IVR or an extension for answering such emergency calls.

1. Log in to the PBX web interface, go to **Call Features > Voicemail**.
2. In the **Caller Options** section, select the checkbox of **Allow callers to press 0 to break out from voicemail**.
3. In the **Destination** drop-down list, select a destination.
 - **IVR**: Forward the call to an [IVR](#).
 - **Extension**: Forward the call to the specific extension.
4. Click **Save** and **Apply**.

Allow Callers to Review Voicemail Messages

The callers can review their voicemail messages after recording. This is important for callers to confirm whether the content of the message is appropriate. This topic describes how to allow callers to review voicemail messages.

Procedure

1. Log in to the PBX web interface, go to **Call Features > Voicemail**.
2. In the **Caller Options** section, select the checkbox of **Allow callers to review message**.
3. Click **Save** and **Apply**.

Global Voicemail Settings

The topic describes the global voicemail message settings, including caller options, message options, and greeting options.

Caller options

Setting	Description
Allow callers to press 0 to break out from voicemail	Allow the caller to press 0 to exit the voicemail, and reach a specific IVR or an extension.
Allow callers to dial extension	Allow the caller to dial other extensions.
Allow callers to press 5 for leaving a message	Allow the caller to press 5 to leave a voicemail message after greeting, instead of auto starting recording immediately.
Allow callers to review message	Allow the caller to review his/her voicemail message after recording.

Message options

Settings	Description
Max Message Time(s)	Set the maximum duration of one voicemail message. The default maximum voicemail duration that callers can leave is 600 seconds (10 minutes).
Min Message Time(s)	Set the minimum duration of one voicemail message. The default minimum voicemail duration that callers must leave is 2 seconds.

Greeting Options

Settings	Description
Max Greeting Time(s)	Set the maximum greeting duration that is played to caller. The default maximum greeting duration is 60 seconds (1 minute).
Global Voicemail Greeting	Select the greeting that is applied to all extensions.

Voicemail Menu Options

This topic shows the quick reference of voicemail menu.

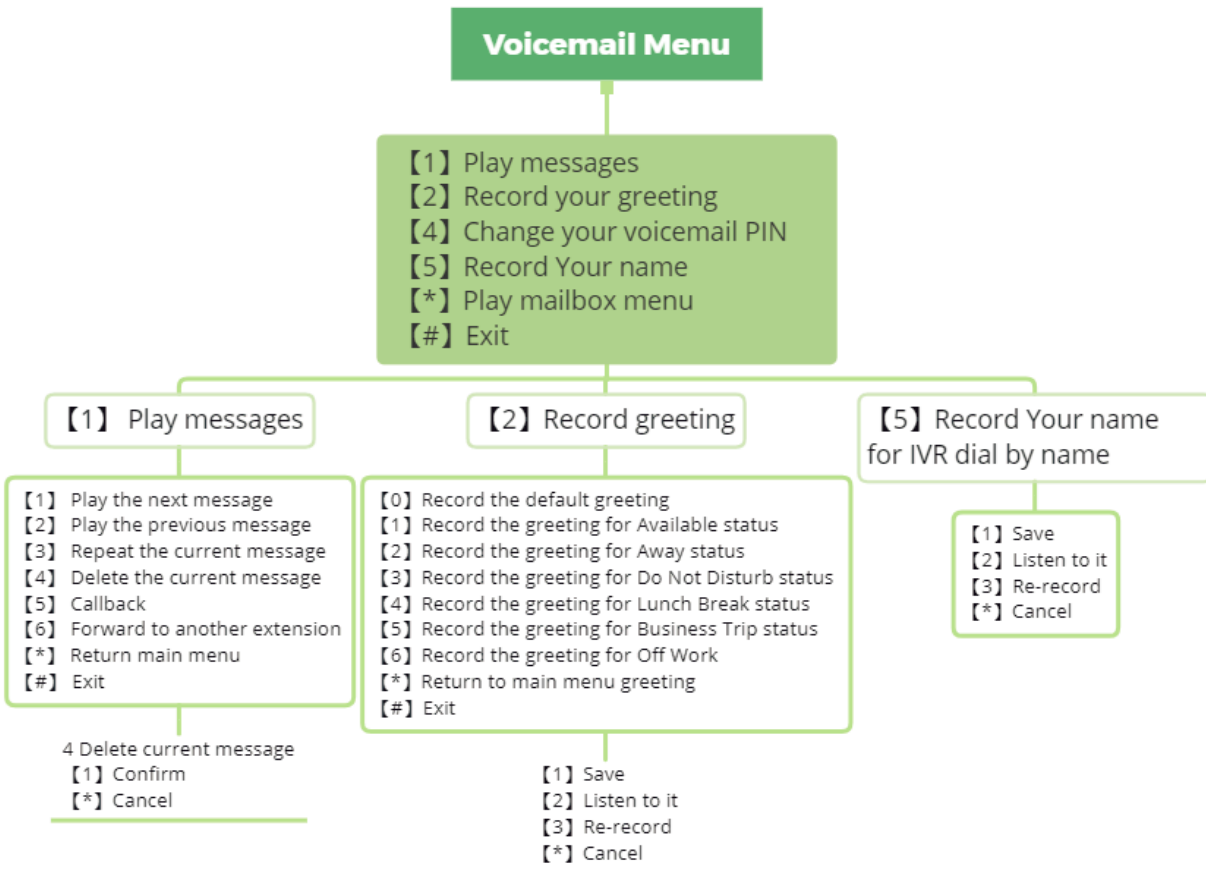

Voicemail Capacity and Limitations

This topic describes the voicemail capacity and limitation for an extension.

Default capacity and limitations for each extension

Voicemail box capacity has a limit of 100 messages with maximum 10 minutes for each message . Once they hit that limit, the system auto deletes the old voicemail messages.

There is no limit of the time to keep the voicemail on PBX.

Adjust the capacity and limitations for each extension

- To get more capacity of voicemail box, see [Auto Cleanup Voicemail Messages](#).
- To increase the limitation of maximum message time, see [Limit Voicemail Message Length](#).

IVR

Interactive Voice Response (IVR) Overview

Yeastar P-Series PBX System integrates a free IVR system. This topic describes what is IVR, what you can do with IVR, and what is multi-level IVR.

What is IVR?

Interactive Voice Response (IVR) is an automated telephony technology that interacts with callers, gathers information, and routes calls to the appropriate destinations. IVR can act as a virtual receptionist to handle large volumes of calls. It means that you don't need a dedicated person to redirect calls to appropriate departments. With IVR, customers can get quick response or access appropriate service on their own.

What you can do with IVR?

Yeastar IVR uses customizable voice prompts to provide callers with instructions and directions for accessing information via phone, such as "press 1 for sales, and press 2 to leave a message.". IVR connects callers to individuals, departments, call queues, etc, based on the customers' selections from voice menus.

Multi-level IVR is an alternative that allows you to assign a new IVR to an IVR option, and provides more powerful options to route incoming calls. Multi-level IVR gives you the flexibility to classify the menu of an interaction, such as divides a sales department into regions, and routes calls more precisely.

You can customize your IVR to provide a seamless experience.

For customer

- Play personal greeting to make the customer feel welcome.
- Allow customer to leave a voicemail.
- Allow customer to call employees directly by dialing extension or by name.

For employee

- Allow employees to dial an outbound call via an IVR.
- Allow employees to check voicemail via an IVR.

IVR keypress events

There are three types of keypress events:

- **Menu options:** The number keys, # key and * key for users to access a desired destination.

- **Timeout:** If no input is detected after the configured timeout, the PBX will forward the call based on the configuration.
- **Invalid:** When an invalid key is pressed, route the call to a desired destination.

Keypress destination

The following options are available for you to assign to the keypress events:

- **Hang up:** End the current call.
- **Extension:** Route the call to the specified extension.
- **Extension Voicemail:** Leave a message for the specified extension.
- **IVR:** Enter another IVR menu.
- **Ring Group:** Route the call to the specified ring group.
- **Queue:** Route the call to the specified queue.
- **Dial by Name:** Place a call by extension's name.

For more information, see [Allow Callers to Dial by Name via IVR](#).

- **External Number:** Route the call to an external number.
- **Play Prompt and Exit:** Play a custom prompt, and then hang up the call.

Set up an IVR

Yeastar P-Series PBX System provides easy-to-create menus that allow you to set up an IVR and keep up with changing requirements. This topic describes how to set up an IVR.

Prerequisites

Before you set up an IVR, [record a custom prompt](#) or [upload a custom prompt](#) to provide callers with the IVR menu.

Procedure

1. Log in to PBX web interface, go to **Call Features > IVR**, click **Add**.
2. In the **Basic** tab, set the basic settings of IVR.
 - **Number:** Specify a virtual number for callers to access the IVR.

The default [IVR number range](#) is from 6200 to 6299.
 - **Name:** Enter an IVR name to help you identify it.
 - **Prompt:** Set the IVR prompt that plays greeting and explains the IVR menu options to callers.

The default prompt is "Dial the extension number or press 0 for operator".

You can select up to 5 audio files, and the system plays the audio files in order.
 - **Prompt Repeat Count:** Set how many times to play the prompt when the caller remains inactive during the **Response Timeout(s)**.
 - **Response Timeout(s):** Set how long (in seconds) to wait for the caller to operate.

- **Digit Timeout(s):** Set how long (in seconds) to wait for the caller to enter the next digit.
 - **Dial Extensions:** Whether to allow callers to dial specific extension numbers via IVR.
 - # **Disable:** Disable to dial extensions via IVR.
 - # **All Extensions:** Allow the callers to dial all the extension numbers.
 - # **Allowed Extensions:** Select the extensions that the callers can dial.
 - # **Restricted Extensions:** Select the extensions that the callers can NOT dial.
 - **Dial Outbound Routes:** Whether to allow callers to dial outbound calls via IVR.
 - **Dial to Check Voicemail:** Whether to allow users to check voicemail via IVR.
3. Click the **Key Press Event** tab, set up an IVR menu.
- In the **Key Press** drop-down list, select a key event for each key: 0-9, *, and #.
 - In the **Response Timeout** drop-down list, select a call routing destination if the caller remains inactive within the **Prompt Repeat Count**.
 - In the **Invalid Input Destination** drop-down list, select a call routing destination if the caller enters a digit that is not defined in the IVR.
 - Optional. Select the checkbox of **Allow Opt-out of Call Recording**.
- When the call is routed to the key press destination, the call would not be recorded even [Call Recording](#) is enabled.
4. Click **Save** and **Apply**.

What to do next

[Set up an inbound route](#), and specify the destination to the IVR.

Set up IVR Prompts

A custom greeting and prompt allow you to provide a more personalized experience for your customers. This topic describes how to set up IVR prompts according to your IVR menu.

IVR prompt types

Generally, an IVR prompt consists of several pieces of information:

- **Welcome greeting:** Welcome greeting is the first message that callers hear when they call in an IVR.
For example, "Thank you for calling Yeastar".
- **Menu prompt:** Present callers with a series of options.
For example, "If you got something urgent, please press 1 to contact our support. To leave a voicemail, please press 2".
- **Goodbye greeting:** Play the greeting before ending a call.

Prepare audio files for IVR prompt

The PBX system has a default IVR prompt. You can customize IVR prompt using a single audio file or multiple audio clips.

Customize IVR prompt by a single audio file

You can record greeting, IVR menu or any messages in a single audio file. It is easy to manage and reduce the number of prompts.

Customize IVR prompt by multiple audio clips

Yeastar IVR also allows you to specify up to 5 different audio files as IVR prompt. The system plays the audio files in order when a customer calls in IVR.

It is better to divide your IVR prompt into multiple audio clips in the following scenarios:

- Modify the IVR prompt frequently.

Every time you modify the IVR menu, you need to update IVR prompt to. Divide your IVR prompt into multiple audio clips according to the content, such as clip 1 for Welcome greeting, clip 2 for menu prompt, and so on. Next time, when you need to change the IVR prompt, just replace the specific clip.

- A single audio file exceeds the limit.

The uploaded file should meet the [audio file requirements](#). You can not upload an audio file larger than 8MB. Divide the audio file into multiple audio clips to solve this issue.

Update the IVR prompts

1. Log in to PBX web interface, go to **PBX Settings > Voice Prompt > Custom Prompt**, [upload a custom prompt](#) or [record a custom prompt](#).

 **Note:** The uploaded file should meet the [audio file requirements](#).

2. Go to **Call Features > IVR**, edit the desired IVR.
3. In the **Prompt** drop-down list, select your custom prompts.

You can select up to 5 audio files, and the system plays the audio files in order.

The screenshot shows the 'Key Press Event' configuration page. The 'Prompt' field is highlighted with a yellow box, indicating the step to select a prompt. The 'Prompt Repeat Count' field is set to 3, which is the step mentioned in the instructions.

4. In the **Prompt Repeat Count** drop-down list, select prompt repeat times.
5. Click **Save** and **Apply**.

Allow Callers to Dial Extensions via IVR

This topic describes how to allow callers to dial extensions directly via an IVR.

Background information

For new customers, IVR can help them reach the desired employee or department. But for old customers, it is inconvenient for them to listen to audio prompts and make selections to reach the right employee or department, even they know the extension number.

For the callers who know the extension number, it is better to allow them to dial an extension number directly.

Prerequisites

Before you set up dial extension directly via an IVR, update your IVR prompt that would instruct callers to dial an extension number.

Procedure

1. Log in to the PBX web interface, go to **Call Features > IVR**, edit the desired IVR.
2. In the **Prompt** drop-down list, select the updated IVR prompt.
3. In the **Dial Extensions** drop-down list, select which extension as available or available for callers to dial.
 - **All Extensions:** The callers can dial all the extensions.
 - **Allow Extensions:** The callers can dial the selected extensions.
 - **Restricted Extensions:** The callers can dial any extensions except the restricted extensions.
4. Click **Save** and **Apply**.

Allow Callers to Dial by Name via IVR

This topic describes how to allow customers to reach an employee just by typing his/her name in an IVR.

Background information

For the customers who don't remember the employee's extension number, you can allow them to call an employee by entering the first three letters of the first name or last name. For example, press 2-4-5 (B-I-L) to call "Bill Johnson".

It is easier for customers to get to the right person.

Add an option for Dial by Name

Prerequisites

Before you set up dial by name, perform the following tasks:

- Specify the first name or last name for employee's extension.
- [Updated your IVR prompt](#) that would instruct callers to dial by first name or last name.

Procedure

1. Log in to the PBX web interface, go to **Call Features > IVR**, edit the desired IVR.
2. In the **Prompt** drop-down list, select the updated IVR prompt.
3. Click **Key Press Event** tab.
4. In the drop-down list of a key press, select **Dial by Name**.
5. Click **Save** and **Apply**.

Default announcement

Yeastar provides the default announcements when the caller selects the **Dial by Name** option. An announcement is played in the following scenarios:

Announcement	scenario
Welcome to the directory. Please enter the first three letters of your party's first name,using your touch tone keypad, use the 7 key for Q, and the 9 key for Z.	Play when the caller presses a key to dial by name.
No directory entries match your search.	Play when there is no matching directory entries after the caller enters three letters.
[Name] extension [Number] If this is the person you are looking for, press 1 now, otherwise please press star now.	Play when there are matching directory entries after the caller enters three letters.

Announcement	scenario
There are no more compatible entries in the directory.	Play when there are no more compatible entries in the directory after the caller presses * key to search.

Allow Callers to Dial Outbound Calls via IVR

This topic describes how to allow callers to dial outbound calls in an IVR.

Background information

Dialing outbound calls via an IVR is useful when you interconnect two PBXs between head-quarter and branch, and only set an IVR on headquarters PBX. You can allow the customers to dial the headquarter's extension number to contact the employees or departments in branch directly.

Prerequisites

- Set up the appropriate [outbound route](#) and [inbound route](#) on the two interconnected PBXs.
- [Upload or record IVR prompt](#) that would instruct customers to dial an outbound call.

Procedure

1. Log in to the PBX web interface, go to **Call Features > IVR**, edit the desired IVR.
2. In the **Prompt** drop-down list, select the updated IVR prompt.
3. Select the checkbox of **Dial Outbound Routes**.
4. Select the desired outbound route from the **Available** box to the **Selected** box.
5. Click **Save** and **Apply**.

Forward Incoming Calls to an External Number via IVR

This topic describes how to allow callers to reach a specific external number in an IVR.

Background information

Forward Incoming Calls to an External Number with IVR is typical and important for 24x7 services, such as Doctor Answering Services and IT Support Services.

For Doctor Answering Services

When a patient calls in an hospital IVR, the patient can press a key to reach the external Doctor Answering Service to schedule an appointment or ask health questions and medical questions.

For IT Support Services

When your customers call in your office IVR after hours, you can give them an option to connect to an emergency support line. This emergency support line can be a Maintenance Engineer's mobile phone number.

Prerequisites

Before you allow callers to reach a specific external number in an IVR, [update your IVR prompt](#) that would instruct callers to press a key to reach the external number.

Procedure

1. Log in to the PBX web interface, go to **Call Features > IVR**, edit the desired IVR.
2. In the **Prompt** drop-down list, select the updated IVR prompt.
3. Click **Key Press Event** tab.
4. Select a key to set key press event to **External Number**.
5. Optional. In the **Prefix** field, enter the [prefix of outbound route](#) so that PBX can successfully route incoming calls to external number.
 - If the **Strip** of outbound route is not set, you don't have to set the **Prefix**.
 - If the **Strip** of outbound route is set, you need to set the **Prefix** according to the **Patterns** of outbound route.
6. Enter the external number, such as a Doctor Answering Service number or a mobile phone number.
7. Click **Save** and **Apply**.

IVR Configuration Example

This topic shows the examples of single IVR configuration and multi-level IVR configuration.

A Single IVR Configuration

Background information

A company needs an IVR to redirect calls to Pre-sales, Support, After-sales, and personal manager.

We assume that all ring groups, call queues, audio prompts, and inbound routes used in this example are previously configured.

Step1. Design an IVR

When the customers dial in IVR (6200), they can access different service based on their business.

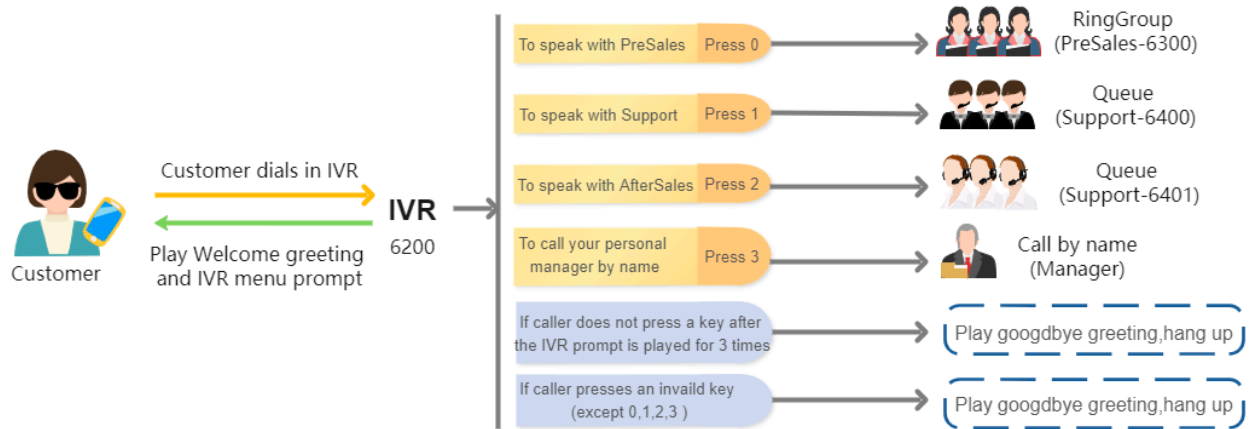

Step2. Upload IVR Prompts

1. Go to **PBX Settings > Voice Prompt > Custom Prompts**, click **Upload**.
2. Select the audio files to upload.

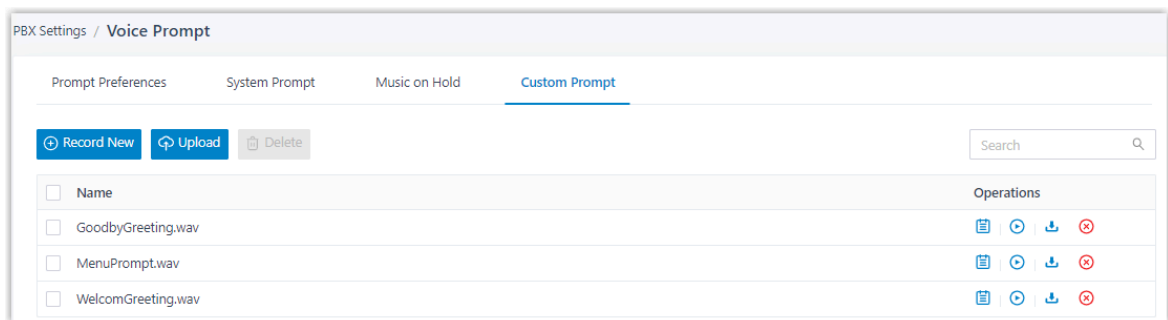

3. Click **Save** and **Apply**.

Step3. Set up an IVR

1. Go to **Call Features > IVR**, click **Add**.
2. In the **Basic** tab, set the basic settings of IVR.

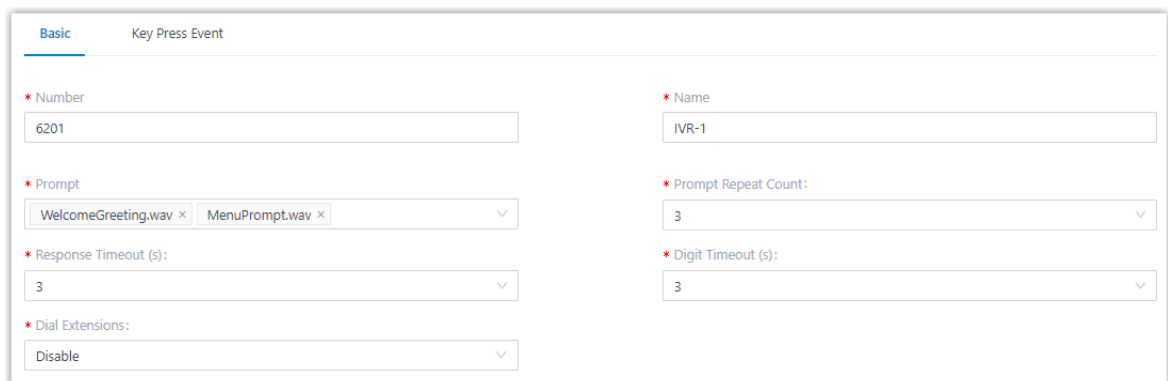

3. In the **Key Press Event** tab, set up an IVR menu.

Basic **Key Press Event**

Press 0 *
 Ring Group 6300 Opt out of being recorded

Press 1 *
 Queue 6400 Opt out of being recorded

Press 2 *
 Queue 6401 Opt out of being recorded

Press 3 *
 Extension 1007-Jason Liang Opt out of being recorded

Response Timeout * *
 Play Prompt and Exit GoodbyGreeting.wav 1

Invalid Input Destination * *
 Play Prompt and Exit GoodbyGreeting.wav 1

4. Click **Save** and **Apply**.

Multi-level IVR Configuration

Background information

As business expands, the company needs to offer callers a bilingual auto-attendant feature based on their language selection. When the customer dials in to IVR, they can select a specific language to be used when playing prompts.

To achieve this, company needs to upgrade its IVR system allowing support of multi-language. We assume that all ring groups, call queues, extensions, audio prompts, and inbound routes used in this example are previously configured.

Step 1. Design IVRs

When the customers dial in to IVR-Main (6200), they can select a specific language to use.

- If customers select Chinese, the call will be redirected to IVR-Chinese (6201).
- If customers select English, the call will be redirected to IVR-English (6202).

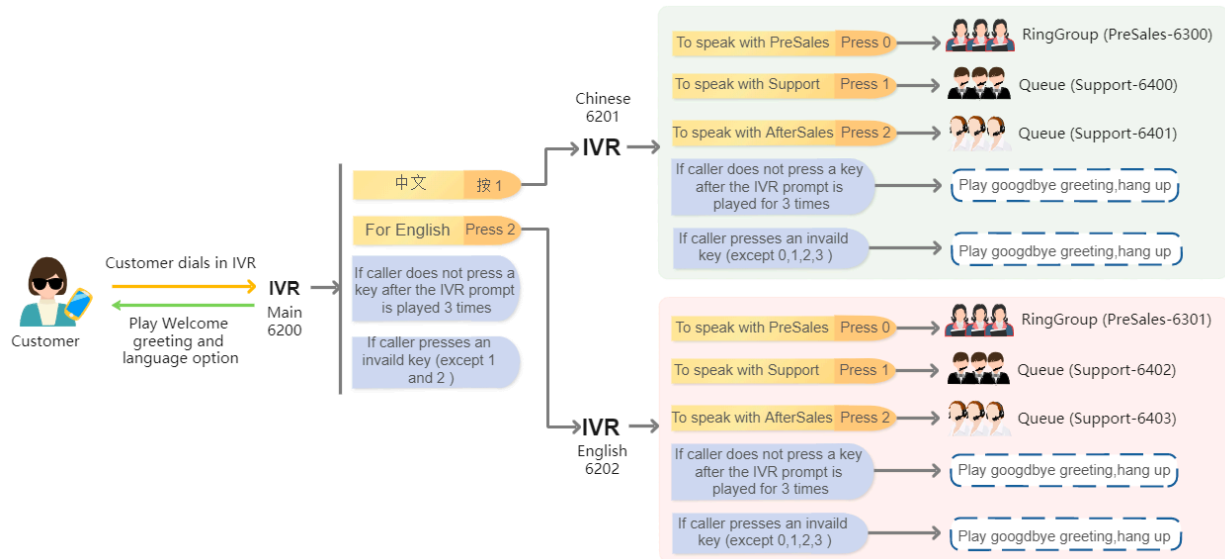

Step 2. Set up IVRs

1. Set up the different IVRs with the same configuration for different language as shown in [a single IVR configuration](#).
 - IVR-1 (6201)
 - IVR-2 (6202)
2. Set up main IVR-Main (6200).
 - a. In the **Basic** tab, set the basic settings of IVR.

The screenshot shows the 'Basic' configuration tab for a 'Key Press Event'. The fields are as follows:

- Number:** 6200
- Name:** Main
- Prompt:** WelcomeGreeting.wav, LanguagePrompt.wav
- Prompt Repeat Count:** 3
- Response Timeout (s):** 3
- Digit Timeout (s):** 3
- Dial Extensions:** 0

- b. In the **Key Press Event** tab, set up an IVR menu.
 - Specify IVR-Chinese (6201) for key 1.
 - Specify IVR-English (6202) for key 2.

3. Click **Save** and **Apply**.

The following figure displays the different IVRs created.

Number	Name	Dial Extensions	Dial Outbound Routes	Operations
<input type="checkbox"/> 6200	Main	Disable	No	Edit Delete
<input type="checkbox"/> 6201	Chinese	All Extensions	No	Edit Delete
<input type="checkbox"/> 6202	English	Disable	No	Edit Delete

Call Recording

Call Recording Overview

Call recording is valuable to keep important conversations, help train employees, evaluate their performance, and provide them with feedback. This topic describes how does call recording work, recording types, recording prompt, and recording management.

How does call recording work

The system records the conversation automatically when a call is established. During call recording, the user can pause and resume recording to avoid the sensitive information being recorded. After the call ends, the system converts the conversation into audio files (.wav) with a digital signature.

 **Note:** The digital signature ensures a recording is not altered in any way.

Recording types

You can set up call recording for extensions, trunks, conferences, and queues respectively.

- **Extensions:** Record all the calls of the specified extensions, including the internal calls and external calls.

 **Note:** Paging/Intercom call and voicemail on the specified extension would not be recorded.

- **Trunks:** Record all the calls on the specified trunks, including inbound calls and outbound calls.

For example, for employees who use a dedicated trunk to deal with customer issues, the system only records all the calls on this trunk.

- **Conferences:** Record the conversation of all members who join in the specified conference rooms.
- **Queues:** Record the calls based on the specified queues.

For example, an agent logs in to two queues(Service and Support), and call recording is enabled for Service. The system can record all the calls from Service, but not record the calls from Support.

 **Note:** The system automatically records a queue call or a conference call only when you activate recording for a queue or conference. For example, extension 1000 is an agent of a queue, you activate recording for extension 1000, but not activate recording for the queue. When extension 1000 answers a queue call, the call is not recorded.

Recording prompts

By default, the system does not play any prompts when a call is being recorded.

To ensure that recordings are lawful and callers have given their consent, you can customize recording prompt for internal calls, inbound calls, and outbound calls respectively. The system plays the recording prompt before call recording begins.

Recording management

- **For users:** The users can monitor call recording status on IP phones, pause and resume recording during a call.
- **For administrator:** The administrator can set up a storage location for recording files, manage the recording files, and grant permission to other users.

Set up Call Recording

This topic describes how to set up call recording for extensions, trunks, conferences, and queues.

Prerequisites

Only when the storage location for recording files is configured will the recording function take effect. For more information, see [manage storage locations](#).

Set up call recording for extensions

The system records the internal calls and external calls on the selected extensions.

1. Log in to the PBX web interface, go to **Call Features > Recording**.
2. **Optional:** Select the checkbox of **Enable Recordings of Internal Calls** to automatically record the internal calls.
3. In the **Record Extensions** section, select the desired extensions from the **Available** box to the **Selected** box.
4. Click **Save** and **Apply**.

Set up call recording for trunks

The system automatically records the external calls on the selected trunks.

1. Log in to the PBX web interface, go to **Call Features > Recording**.
2. In the **Record Trunks** section, select the desired trunks from the **Available** box to the **Selected** box.
3. Click **Save** and **Apply**.

Set up call recording for conferences

The system automatically records the calls on the selected conferences.

1. Log in to the PBX web interface, go to **Call Features > Recording**.
2. In the **Record Conferences** section, select the desired conferences from the **Available** box to the **Selected** box.
3. Click **Save** and **Apply**.

Set up call recording for queues

The system automatically records the calls on the selected queues.

1. Log in to the PBX web interface, go to **Call Features > Recording**.
2. In the **Record Queues** section, select the desired queues from the **Available** box to the **Selected** box.
3. Click **Save** and **Apply**.

Set up Recording Prompts

This topic describes how to set up recording prompts for internal calls, inbound calls, and outbound calls respectively.

Set up recording prompt for internal calls

1. Log in to the PBX web interface, go to **PBX Settings > Voice Prompt > Custom Prompt**, upload a custom prompt or record a custom prompt for internal calls.

 **Note:** The uploaded file should meet the [audio file requirements](#).

2. Go to **Call Features > Recording**.
3. In the **Internal Call Being Recorded Prompt** drop-down list, select a prompt for internal calls.
4. Click **Save** and **Apply**.

Set up recording prompt for inbound calls

1. Log in to the PBX web interface, go to **PBX Settings > Voice Prompt > Custom Prompt**, upload a custom prompt or record a custom prompt for inbound calls.

 **Note:** The uploaded file should meet the [audio file requirements](#).

2. Go to **Call Features > Recording**.
3. In the **Inbound Call Being Recorded Prompt** drop-down list, select a prompt for inbound calls.
4. Click **Save** and **Apply**.

Set up recording prompt for outbound calls

1. Log in to the PBX web interface, go to **PBX Settings > Voice Prompt > Custom Prompt**, upload a custom prompt or record a custom prompt for outbound calls.

 **Note:** The uploaded file should meet the [audio file requirements](#).

2. Go to **Call Features > Recording**.
3. In the **Outbound Call Being Recorded Prompt** drop-down list, select a prompt for outbound calls.
4. Click **Save** and **Apply**.

Pause or Resume Call Recording

To avoid sensitive personal information such as credit card details being recorded, you can pause the recording by a feature code. This topic describes how to pause or resume recording.

Background information

The default feature code for pausing or resuming recording is *1. You can change, enable, or disable the code on PBX web interface: **Call Features > Feature Code > Recording > Pause/Resume Recording**.

Allow extension user to pause or resume call recording

1. Log in to the PBX web interface, go to **Extension and Trunk > Extension**, edit a desired extension.
2. Click **Features** tab.
3. In the **Call Recording** section, select the checkbox of **Allow the extension to stop or restart call recording during a call**.
4. Click **Save** and **Apply**.

Result

During a call, do the following to pause or resume call recording:

- **To pause call recording:** Press the feature code (*1) to pause the call recording. When you play the recording files, the paused part is absent.
- **To resume call recording:** Press the feature code (*1) again to resume the call recording.

Monitor Call Recording Status on an IP phone

This topic describes how to set up a BLF key on an IP phone to monitor the call recording status.

Background information

For the users that want to know whether the call recording state is switched successfully or not, you can set a BLF key for each user by [auto provisioning](#).

 **Note:** Users can also set function keys on their own IP phones. For more information, contact the phone manufacturer.

Procedure

1. Assign function keys for extension users to monitor agent status.
 - a. Log in to the PBX web interface, go to **Extension and Trunk > Extension**, edit the desired extension.
 - If you want to assign function keys for a specific extension user, click  beside the desired extension.
 - If you want to assign function keys for multiple extensions, select the checkboxes of the desired extensions, and click **Edit**.
 - b. Click the **Function Keys** tab.
 - c. Configure function keys.

 **Note:** The number of programmable keys varies by phone models. If the number of function keys you assign to an extension exceeds the number of programmable keys, the redundant function keys cannot take effect.

- **Type:** Select **BLF**.
 - **Value:** Enter the code (*1) followed by extension number (for example *11000).
 - **Label:** Optional. Enter a value, which will be displayed on the phone screen.
- d. Click **Save**.
2. If the extension haven't be associated with a phone, see [Auto Provision IP Phones](#) to bind a phone with the extension.
 3. If the extension have been associated with a phone, reprovision the phone to take effect.
 - a. Go to **Auto Provisioning > Phones**.
 - b. Click  beside the phone assigned to this extension.

Result

The BLF key shows the real-time status of call recording.

- **Red:** An active call of the monitored extension is being recorded.
- **Green:** An active call of the monitored extension is not in a call or the call recording is paused.
- **Off:** The BLF key does not subscribe the recording status of this extension. Check if your configurations are correct.

 **Note:** The key LED status may vary by phone models.



Manage Call Recording Files

This topic describes how to manage call recording files, including searching, playing, downloading, or deleting the recording files.

Search recording files

You can search the recording files by time, caller number, callee number, or call ID.



1. Log in to the PBX web interface, go to **Reports and Recordings > Recording Files**.
2. Set the search criteria.
 - **Time:** Set the start date and the end date.
To specify a time period, click **select time** to set the start time and the end time.
 - **Call From:** Set the caller's number or name.
 - **Call To:** Set the callee's number or name.

 **Tip:** To swap the callee for the caller, click .

 - **ID:** Enter the unique identifier for the recording file.

The search results are displayed in the list.

Play recording files

1. Log in to the PBX web interface, go to **Reports and Recordings > Recording Files**.
2. Click  beside the recording that you want to listen to.
 - **Play on Web:** Click  to play the call recording on the web directly.
 - **Play to Extension:** Play the call recording on the phone.
 - a. Select an extension, and click **Play**.
The system places a call to the extension.
 - b. Pick up the call to listen to the call recording on the phone.

Download recording files

 **Note:** You can download a maximum of 600MB recording files or a maximum of 100 recording files at a time. The recordings that exceed the limit will not be downloaded.

1. Log in to the PBX web interface, go to **Reports and Recordings > Recording Files**.
2. To download a recording file, click  beside a recording log.
3. To download multiple recording files, do the following:
 - a. Select the checkboxes of recording files that you want to download.
 - b. Click **Download Recording(s)**.

Delete recording files

1. Log in to the PBX web interface, go to **Reports and Recordings > Recording Files**.
2. Delete a recording file, or delete recording files in bulk.
 - **Delete a recording:** Select the recording file that you want to delete, click  and **OK**.
 - **Delete recordings in bulk:** Select the checkboxes of the recording files that you want to delete, click **Delete** and **OK**.

Auto Clean up Recording Files

Clean up old recording files to free up space. This topic describes how to set up auto cleanup of recording files.

Background information

By default, when the storage device reaches 80% of its [maximum storage capacity](#), the PBX automatically deletes the oldest recording files.

Procedure

1. Log in to the PBX web interface, go to **System > Storage > Auto Cleanup > Recording Auto Cleanup**.
2. In the **Max Usage of Device (%)** drop-down list, select the maximum storage percentage of the device that is allowed to store recording files.
3. In the **Recordings Preservation Days**, enter the maximum number of days that the recording files should be retained.

The value 0 indicates no limit.

4. Click **Save** and **Apply**.

 **Note:** If [Auto Clean up Reminder](#) is enabled, and the retained recording files reach 90% of threshold, the system sends you a notification email. If the old recording files have continuing retention value, you can backup recording files or expand the retain limit in time.

Grant Manage Permission of Recording Files

By default, only the super administrator has permission to manage the call recording files. This topic describes how to grant manage permission to extension users.

Background information

As a super administrator, you can grant manage permission to a role, and assign the role to extension users. When the user logs in to the web client, he/she can manage recording files.

Procedure

1. Set up a user role.
 - a. Log in to the PBX web interface, go to **Extension and Trunk > Role**, edit a role.
 - b. In the **Reports and Recordings** section, specify the manageable extensions and accessible permissions of recordings files for the role.
 - **Manage Extensions:** Specify the manageable extension range.
 - **Recording Files Operation Permission:** Specify the accessible permission, including **Play**, **Download**, and **Delete**.
 - c. click **Save**.
2. Assign a role to a user.
 - a. Go to **Extension**, edit the extension to which you want to grant recording permission.
 - b. In the **User Information** section, select the role from the **User Role** drop-down list.
 - c. Click **Save** and **Apply**.

Ring Group

Ring Group Overview

Ring group is a feature to share the distribution of incoming calls among employees. This topic describes what is ring group, ring strategy and failover destination.

What is ring group

Ring group allows you to merge multiple extension numbers into a virtual number. The customers can dial the virtual number, and the calls ring through all the members to make sure that no call goes unanswered. It is often used to efficiently distribute calls to specific departments such as Sales, Support, and Accounting.

Ring strategy

Ring group can ring members in two ways:

- **Ring all simultaneously:** When receiving an incoming call, the system rings all the available members at the same time and stops ringing when any member in the group picks up the call. If no one answers the call within the ring time, the system routes the call to the failover destination.

You can set this option for teams such as Support or Customer Service, where all members are equally responsible for answering incoming calls.

- **Ring sequentially:** When receiving an incoming call, the system rings the first available member in the list firstly. If no answer within the ring time, the system rings the next available member until the last one. If no one answers the call, the system routes the call to the failover destination.

You can set this option for receptionist who holds the primary responsibility for answering the phone while other individuals acting as backups.

Failover destination

When a call comes in to the ring group, and no one is available to answer the call, you can end the call or route the call to the following destinations:

- Hang Up
- Extension
- Extension Voicemail
- IVR
- Ring Group
- Queue
- External Number
- Play Prompt and Exit

Create a Ring Group

This topic describes how to create a ring group.

Procedure

1. Log in to the PBX web interface, go to **Call Features > Ring Group**, click **Add**.
2. Configure the ring group.
 - **Number:** Enter a virtual number for callers to access the group.

The default ring group [number range](#) is from 6300 to 6399.
 - **Name:** Enter a group name to help you identify it.
 - **Ring Strategy:** Select a ring method to distribute calls to members.
 - # Ring All: ring all available extensions simultaneously.
 - # Ring Sequentially: ring all available extensions sequentially.
 - **Ring Timeout (s):** Set a number of seconds that the system waits before ringing next member or routing the call to **Failover Destination**.
 - **Members:** Select the desired extensions from the **Available** box to the **Selected** box.
 - **Failover Destination:** Select a destination to route the call when no member answers the call within ring time.
 - # **Hang up:** End the current call.
 - # **Extension:** Route the call to the specified extension.
 - # **Extension Voicemail:** Route the call to voicemail box of the specified extension.
 - # **IVR:** Route the call to the specified IVR.
 - # **Ring Group:** Route the call to another ring group.
 - # **Queue:** Route the call to the specified queue.
 - # **External Number:** Route the call to an external number.
 - # **Play Prompt and Exit:** Play a custom prompt, and then hang up the call.
3. Click **Save** and **Apply**.

What to do next

[Set up an inbound route](#), and specify the destination to the queue.

Manage Ring Groups

This topic describes how to edit a ring group, delete ring groups.

Edit a ring group

You can edit the group settings, including adding or removing a member, or change the ring strategy.

1. Log in to the PBX web interface, go to **Call Features > Ring Group**.
2. Click  beside the ring group that you want to edit.

3. Change the ring group settings according to your needs.
4. Click **Save** and **Apply**.

Delete ring groups

1. Log in to the PBX web interface, go to **Call Features > Ring Group**.
2. To delete a ring group, click  beside the ring group that you want to delete.
3. To delete ring groups in bulk, select the checkboxes of the ring groups that you want to delete, click **Delete**.
4. Click **OK** and **Apply**.

Call Queue

Call Queue Overview

Call queue is a method of handling large calls and provides callers with engaging holding experiences. This topic describes what is call queue, queue compositions, queue preference, and call center service.

What is call queue

A queue is like a virtual waiting room, in which callers wait in line to talk with the available agent. When the customer calls in PBX and reaches the queue, he/she can hear the hold music and announcement while the queue distributing the call to the available agents.

Queue components

A queue call consists of the following parts:

- **Callers:** Customers who place calls to the queue.
- **Agents:** Members who answer the queue calls (extensions or users that log in as agents)
 - # **Static agent:** The agent is always a member of the queue and cannot log out.
 - # **Dynamic agent:** The agent can log in to or log out of a queue at any time.
- **Announcement:** Announcements played to callers and agents, including agent ID announcement, position announcement, and periodic announcement.
- **Music on Hold:** Music or advertisements played to callers while waiting in the queue.
- **Ring Strategy:** A strategy for how to distribute calls to agents.
- **Failover destination:** A destination to which calls will be routed in the following scenarios.
 - # The number of callers that wait in a queue reaches the **Maximum Callers In Queue**.
 - # The time that callers wait reaches the **Maximum Waiting Time**.
 - # No agents in queue and the caller is pulled out of a queue.

Call Center service

Call Center service is an additional service that drives faster call resolution and real-time call center monitoring, reporting and management. It provides a powerful call center console, including a customizable Wallboard for proactive tracking of 16 key performance metrics, and a switchboard-type Queue Panel for real-time monitoring & control of queue activities, insightful call center reports, SLA and more.

For more information on call center service, see [Call Center Console User Guide](#).

 **Note:** For call center service, contact Yeastar support.

Queue preference

Queue preference settings are available, including queue capacity, service level agreement, announcement, and satisfaction survey.

- Queue capacity
 - # Define the maximum number of calls to wait in the queue.
 - # Whether to pull the caller out of queue when no agents available in the queue.
 - # Whether to allow the caller to join in when no agents in the queue.

- Service Level Agreement (SLA)

With call center service activated, you can use SLA to define a certain level of service in a call center scenario, such as answering 80% of calls within 20 seconds.

- Announcement
 - # Caller announcement, including the agent ID announcement and position announcement.
 - # Periodic announcement

- Satisfaction survey

In a call center scenario, you can make a satisfaction survey to collect customer feedback.

Create a Queue

You can create and design queues to allow callers to talk with agents according to your business. This topic describes how to create a queue.

Prerequisites

- Customize a [voice prompt](#) as agent announcement.
- Configure the [Music on Hold](#) for the queue.

Procedure

1. Log in to the PBX web interface, go to **Call Features > Queue**, click **Add**.

2. In the **Basic** page, configure the basic settings for the queue and agent settings.

a. In the **Basic** section, configure the following settings:

- **Number:** Enter a virtual number for callers to access the queue.

The default queue [number range](#) is from 6400 to 6499.

- **Name:** Enter a queue name to help you identify it.
- **Ring Strategy:** Select a ring method to distribute calls to agents.
 - # **Ring All:** Ring all available agents simultaneously until someone answers.
 - # **Least Recent:** Ring the available agent that was least recently called.
 - # **Fewest Calls:** Ring the available agent with the fewest completed calls.
 - # **Random:** Ring the agents randomly.
 - # **Rmemory:** Round robin with memory.

The system remembers the last agent it tried and rings the next agent.

Linear: Rings agents in the order specified in the agents list.

- **Music On Hold:** Select a prompt to play to callers waiting for an available agent.
- **Maximum Waiting Time(s):** Set a number of seconds that the caller can wait for an available agent.
- **Failover Destination:** Select a destination to route the call when the call is not answered by any agent.
 - # **Hang up:** End the current call.
 - # **Extension:** Route the call to the specified extension.
 - # **Extension Voicemail:** Route the call to voicemail box of the specified extension.
 - # **IVR:** Route the call to the specified IVR.
 - # **Ring Group:** Route the call to another ring group.
 - # **Queue:** Route the call to the specified queue.
 - # **External Number:** Route the call to an external number.
 - # **Play Prompt and Exit:** Play a custom prompt, and then hang up the call.

b. In the **Agent Options** section, configure the following settings.

- **Agent Timeout(s):** Set a number of seconds that the system rings an agent's phone.
- **Retry Interval(s):** Set a number of seconds to wait before trying all the agents again.
- **Wrap-up Time(s):** Set a number of seconds for agents to complete post-call processing after finishing a call.

The next call will come after this period following the ring strategy.

- **Agent Announcement:** Select a prompt to play to agent prior to bridging in the caller.
- **Ring In Use:** Set whether to distribute additional queue calls to the agents who are already in calls.

3. Click the **Members** tab, set agents for the queue.
 - **Dynamic Agents:** Select the dynamic agents that can log in to or log out of a queue at any time.

 **Note:** The queue distributes calls to the dynamic agents only when they log in to the queue and unpause the queue calls.

- **Static Agents:** Select the static agents that are always stay in the queue.

 **Note:** Static agents do not need to “log in” to the queue, and cannot “log out” of the queue.

4. Click **Preferences** tab to customize the queue according to your needs.

For more information of the preference settings, see [Queue Preferences](#).

5. Click **Save** and **Apply**.

What to do next

[Set up an inbound route](#), and specify a destination to the queue.

Manage Call Queues

You can not change the queue number after setting up a queue. This topic describes how to edit a queue, and delete queues.

Edit a queue

You can manage the agents, change the ring strategy or other queue settings.

1. Log in to the PBX web interface, go to **Call Features > Queue**.
2. Click  beside the queue that you want to edit.
3. Change the queue settings according to your needs.
4. Click **Save** and **Apply**.

Delete queues

1. Log in to the PBX web interface, go to **Call Features > Queue**.
2. To delete a queue, do the followings:
 - a. Click  beside the queue that you want to delete.
 - b. Click **OK** and **Apply**.
3. To delete queues in bulk, do the followings:
 - a. Select the checkboxes of the queues that you want to delete, click **Delete**.
 - b. Click **OK** and **Apply**.

Manage Agent Status by Dialing a Feature Code

This topic describes how to manage agent status by dialing a feature code.

Background information

The PBX defines feature codes that allow the agents to switch their status. You can change, enable, or disable the feature code on PBX web interface: **Call Features > Feature Code > Queue**.

The default feature codes for switching agent:

- **Login/Logout:** *7
- **Pause/unpause:** *07

Log in a queue

Only dynamic agents can log in to a queue; static agents are always in the queue.

For example, a dynamic agent dials *76400 to log in to queue 6400.

Log out of a queue

Only dynamic agents can log out of a queue; static agents are always in the queue.

For example, a dynamic agent 1000 dials *76400 to log out of queue 6400.

Pause receiving queue calls

Both static agents and dynamic agents can pause the queue calls when they are away from desk. The system will not distribute queue calls to the agents in "Paused" status.

For example, an agent 1000 dials *076400 to pause calls from queue 6400.

Unpause receiving queue calls

Both static agents and dynamic agents can unpause queue calls when they are ready to take calls.

For example, an agent 1000 dials *076400 to unpause calls from queue 6400.

Related information

[Monitor and Switch Agent Status on an IP Phone](#)

Monitor and Switch Agent Status on an IP Phone

This topic describes how to set up function keys on agents' phones to monitor and switch agent status.

Background information

There are two ways to monitor and switch agent status:

- **Function key:** For agents who want to monitor their own status in a specific queue on their phones, you can set a function key for each agent by [auto provisioning](#).

Note: Agents can also set function keys on their own IP phones. For more information, contact the phone manufacturer.

- **Queue Panel:** If you have activated Call Center service, agents can monitor and switch their status on queue panel. For more information, see [Call Center Console User Guide](#).

Procedure

Assume that an agent Sunny wants to monitor and switch her status in the "Support" queue on IP phone.

You can set two function keys for the agent Sunny as follows:

1. Assign function keys for the agent.
 - a. Log in to the PBX web interface, go to **Extension and Trunk > Extension**, edit the agent's extension.
 - b. Click the **Function Keys** tab.

Note: Function Key feature is only supported on SIP extensions.

- c. Configure function keys.

Note: The number of programmable keys varies by phone models. If the number of function keys you assign to an agent exceeds the number of programmable keys, the redundant function keys cannot take effect.

- **Type:** Select a key type.
 - # Select **Agent Login/Logout** for logging in to or logging out of a queue.
 - # Select **Agent Pause/Unpause** for pausing or unpausing receiving queue calls.
- **Value:** Select the "Support" queue that the agent sits in.
- **Label:** Optional. Enter a value, which will be displayed on the phone screen.

- d. Click **Save**.

Function Key	Type	Value	Label	Operations	Sort
Key 1	Agent Login/Logout	Support	Login/Logout		
Key 2	Agent Pause/Unpause	Support	Pause/Unpause		
Key 3	N/A				

2. If the agent hasn't be associated with a phone, see [Auto Provision IP Phones](#) to bind a phone with the agent.

3. If the agent has been associated with a phone, reprovision the phone to take effect.
 - a. Go to **Auto Provisioning > Phones**.
 - b. Click  beside the phone assigned to the agent.

Result

The LED status of function keys shows the agent's status in real time.

 **Note:** The key LED status may vary by phone models.

Function key	LED status	Description
Login/Logout	Green	The monitored agent has logged in to the queue and unpaused queue calls. The agent can press the Login/Logout function key to log out of the queue.
	Red	The monitored agent has logged out of the queue. The agent can press the Login/Logout function key to log in to the queue.
	Off	The function key does not subscribe the agent's status. Check if your configurations are correct or if the agent's extension is registered.
Pause/unpause	Green	The monitored agent has logged in to the queue and unpaused queue calls. The agent can press the Pause/Unpause function key to pause receiving queue calls.
	Flashing Red	The monitored agent has paused receiving queue calls. The agent can press the Pause/Unpause function key to resume receiving queue calls.
	Off	The function key does not subscribe the agent's status. Check if your configurations are correct or if the agent's extension is registered.

Queue Preferences

This topic describes the queue preference settings, including queue capacity, service level agreement, announcement, and satisfaction survey.

Queue capacity

Setting	Description
Maximum Callers in Queue	The maximum number of callers that can wait in the queue. The default value is 0 (unlimited).

Setting	Description
	 Note: When the number of callers waiting in queue reaches the Maximum Callers In Queue , the system routes the additional calls to Failover Destination .
Leave Empty	Pull the caller out of a queue when no agents in the queue, and forward the call to the Failover Destination .
Join Empty	Allow callers to join a queue when there is no agent in the queue.

Service level agreement

Setting	Description
SLA Time(s)	The maximum amount of time (in seconds) that an agent need to answer an incoming call. The default SLA time is 60 seconds.
Evaluation Interval(min)	The time interval to compare the queue's SLA performance against the alarm threshold so the system can send a notification email accordingly.
Alarm Threshold(%)	The service level threshold for the queue. The default alarm threshold is 80%.

Announcement

Setting	Description
Announcement	
Join Announcement	The announcement played to callers before they join the queue.
Agent ID Announcement	The announcement played to callers to prompt the agent ID. <ul style="list-style-type: none"> • Default: The system plays the prompt “<i>{extension_number}</i> will be connected. Please wait”. • Custom prompt: If you choose your custom prompt, the system will play <i>{extension_number}</i> + your custom prompt.
Call Position Announcement	
Announce Position	Announce position of caller in the queue.
Announcement Hold Time	Announce the hold time to the caller periodically based on Frequency .
Frequency(s)	The time interval to announce queue position and estimated hold time to the caller.

Setting	Description
Queue Announcements	
Prompt	The announcement played to callers periodically.
Frequency(s)	The time interval to play the announcements.

Satisfaction survey

Setting	Description
Satisfaction Survey Prompt	<p>The prompt played to caller to ask the caller to rate their satisfaction scale after the agent hangs up.</p> <p>The default prompt is "Please rate your satisfaction with our service, press 1 for satisfied, press 2 for dissatisfied. Thank you.". "Thanks for your calling, goodbye." is prompted after the caller presses a key.</p>

Key Press Event

Setting	Description
Key	<p>The caller can press the key to enter the specific destination when waiting in queue.</p> <p>Generally, set a Periodic Announcements to guide the callers to press the key.</p>
Key Destination	<p>The destination to route the call when the caller presses a key.</p> <ul style="list-style-type: none"> • Hang up: End the current call. • Extension: Route the call to the specified extension. • Extension Voicemail: Route the call to voicemail box of the specified extension. • IVR: Route the call to the specified IVR. • Ring Group: Route the call to another ring group. • Queue: Route the call to the specified ring group. • External Number: Route the call to an external number. • Play Prompt and Exit: Play a custom prompt, and then hang up the call.

Feature Code

Configure feature codes

Feature codes are a set of digits that the extension user can dial to activate a specific feature. This topic describes how to configure feature codes.

Background information

Yeastar P-Series PBX System provides various feature codes for users to activate or deactivate a specific feature. You can change, enable, or disable the code, and change the digit timeout for entering the feature code.

For more information on feature code, see [Feature Code Reference](#).

Procedure

1. Log in to the PBX web interface, go to **Call Features > Feature Code**.
2. In the **Feature Code Digit Timeout (ms)** field, enter a number of seconds for inputting next digit.

The digit timeout is the time between consecutive key presses on the phone's keypad.

3. Decide whether to enable or disable a feature code.
 - **Enable a feature code:** Select the checkbox of the specific feature code.
 - **Disable a feature code:** Unselect the checkbox of the specific feature code.
4. **Optional:** Change the code according to your needs.
5. Click **Save** and **Apply**.

Feature Code Reference

This topic describes the list of default feature codes.

Recording

Name	Default Code	Usage
Pause/Resume Recording	*1	Press *1 during a call to pause recording; Press *1 again to resume recording.

Voicemail

Name	Default code	Usage
Check Voicemail/Subscribe Voicemail Status	*2	Dial *21000 to check the voicemail of extension 1000.

Name	Default code	Usage
Leave a Voicemail for an Extension	*12	Dial *121000 to leave a voicemail message for extension 1000.

Call Transfer

Name	Default code	Usage
Attended Transfer	*3	Press *31000 to attended transfer a call to extension 1000.
Blind Transfer	*03	Press *031000 to blind transfer a call to extension 1000.

Call Pickup

Name	Default code	Usage
Group Call Pickup	*4	Dial *4 to pick up the ringing call for a group member.
Extension Pickup	*04	Dial *041000 to pick up the ringing call for extension 1000.

Call Parking

Name	Default code	Usage
Call Parking	*5	Dial *5 during a call to park a call.
Directed Call Parking	*05	Dial *056000 during a call to park a call to parking number 6000.

Intercom

Name	Default code	Usage
Intercom	*6	<ul style="list-style-type: none"> Dial *61001 to place an intercom call to extension 1001.

Queue

Name	Default code	Usage
Login/Logout	*7	<ul style="list-style-type: none"> A dynamic agent dials *7 to log in to or log out of all assigned queues. A dynamic agent dials *76400 to log in to or log out of queue 6400.
Pause/Unpause	*07	<ul style="list-style-type: none"> A dynamic agent dials *07 to pause or unpause calls from all assigned queues.

Name	Default code	Usage
		<ul style="list-style-type: none"> A dynamic agent dials *076400 to pause or unpause calls from queue 6400.

Speed Dial

Name	Default code	Usage
Speed Dial Prefix	*89	Specify a number to speed dial code 1, dial *891 to dial the specified number.

Switch Business Hours Status

Name	Default code	Usage
Switch Business Hours Status	*99	Dial *99 to switch the system in or outside business hours.

Conference

Conference Overview

Conference calls increase employee efficiency and productivity, and provide a more cost-effective way to hold meetings. This topic describes what is conference call, and conference member.

What is conference call

Yeastar P-Series PBX System supports dial-in conference that allows multiple participants, including internal users and external users, to start a conference call, and talk to each other anywhere and anytime.

Conference member

- **Moderator:** The conference moderator is a participant who can lock the conference call and manage the participants in a conference call.
- **Participant:** The conference member who can talk with each other and adjust the volume.

Create a Conference Room

To make a conference call, you should create a conference room on Yeastar P-Series PBX System first. This topic describes how to create a conference room.

Procedure

1. Log in to the PBX web interface, go to **Call Features > Conference**, click **Add**.
2. Set up the conference room.
 - **Number**: Enter a room number for callers to dial into the conference call.
 - **Name**: Enter a room name to help you identify it.
 - **Participant Password**: Optional. The participants need to enter the password to join conference call.
 - **Moderator Password**: Optional. The participants can enter the password to join conference call as moderators.
 - **Voice Prompt**: Select a prompt to announce to the participants when someone joins or exits from the conference call.
 - # **Default**: Prompt a tone when participant joins or exits from conference call.
 - # **Extension**: Prompt the extension number of the participant when the participant joins or exits from conference call.
 - **Wait for Moderator**: Whether to forbid the participants to talk with each other till the moderator joins the conference call.
 - **Allow Participants to Invite**: Whether to allow the participants to invite users to join the conference.
 - **Moderator(s)**: Select the moderators.

The moderators can join the conference calls without any password.
3. Click **Save** and **Apply**.

What to do next

If the external participants want to join conference, you need to set an [inbound route](#) and specify the **Destination** to **Conference**.

Join a Conference Call

Both the PBX extension users and the external users can join the conference. This topic describes how to join a conference call.

Join as a conference participant

1. Dial the conference room number.
2. If participant password is required, enter the participant password.

If you are the first participant in the conference call, the system plays a [hold music](#) to you.

Join as a conference moderator

For moderators

If you are a moderator specified by administrator, you can dial the conference room number to join the conference call.

If you are the first participant in the conference call, the system plays a [hold music](#) to you.

For participants who want to join conference as moderators

If you are not a moderator, and the moderator password is set for the conference room, you can also join conference call as a moderator

1. Dial the conference room number.
2. Enter the moderator password.

If you are the first participant in the conference call, the system plays a [hold music](#) to you.

Invite Users to a Conference Call

By default, only the conference moderators can invite users to the conference. This topic describes how to allow participants to invite users and how to invite users to a conference call.

Allow participants to invite users

1. Log in to the PBX web interface, go to **Call Features > Conference**, edit the desired conference.
2. Select the checkbox of **Allow Participants to Invite**.
3. Click **Save** and **Apply**.

Invite users to a conference call

1. During a conference call, press the # key.

You are forced out of the conference call temporarily.

2. Dial the number that you want to invite.

After the invited user joins or rejects the conference call, you will return to the conference call.

Manage Conference Rooms

This topic describes how to edit conference room settings and delete conference rooms.

Edit a conference room

 **Note:** You can not change the conference room number after setting up a conference room.

1. Log in to the PBX web interface, go to **Call Features > Conference**.
2. Click  beside the conference room that you want to edit.
3. Change the conference room settings according to your needs.
4. Click **Save** and **Apply**.

Delete conference rooms

You can delete a conference room, or delete conference rooms in bulk.

1. Log in to the PBX web interface, go to **Call Features > Conference**.
2. To delete a conference room, do the following:
 - a. Click  beside the conference room that you want to delete.
 - b. Click **OK** and **Apply**.
3. Delete conference rooms in bulk, do the following:
 - a. Select the checkboxes of the conference rooms that you want to delete, click **Delete**.
 - b. Click **OK** and **Apply**.

Conference Voice Menu

This topic describes the conference voice menu.

During the conference call, the participants can manage the conference by pressing * key on their phones to access voice menu for conference room.

The following table shows the conference voice menu.

Key	Description	Moderator	Participant
1	Mute or unmute yourself.	#	#
2	Lock or unlock the conference.	#	×
3	Eject the last user.	#	×
4	Decrease the conference volume.	#	#
6	Increase the conference volume.	#	#
7	Decrease your volume.	#	#
8	Exit the voice menu.	#	#
9	Increase your volume.	#	#

Speed Dial

Speed Dial Overview

Speed dial is often the easiest way to quickly connect with people and extensions that you dial frequently. This topic describes what is speed dial, and how to use speed dial.

What is speed dial

Speed dial is a feature that allows you to assign a speed dial code to a number that the users frequently dial. When dialing long strings of overseas numbers, the users do not have to remember or enter long telephone numbers on their phones.

How to use speed dial

You can create speed dial with a **Prefix** in front of the **Speed Dial Number** to avoid interference with your extensions.

- **Speed Dial Number:** The shorter number you assign to the phone number.
- **Prefix:** The code to access the speed dial feature. The default prefix is *89.

The users can dial `{prefix}+{speed_dial_number}` to call an assigned phone number. For example, assign 1 to phone number 5503302, dial *891 to place a call to 5503302.

Set up Speed Dial Prefix

You need to dial the speed dial code with a prefix. The prefix is used to access the speed dial feature, and avoid interference with the extensions. This topic describes how to set up speed dial prefix.

Procedure

1. Log in to the PBX web interface, go to **Call Features > Speed Dial**.
2. Click **Prefix**.
3. In the **Speed Dial Prefix** field, enter a prefix according to your needs..
The default speed dial prefix is *89.
4. Click **Save** and **Apply**.

i Tip: To disable the speed dial prefix, go to **Call Features > Feature code > Speed Dial > Speed Dial Prefix**.

Add a Speed Dial Number

This topic describes how to add a speed dial number.

Background information

- Assume that you have an outbound route that allows you to dial an external number 15990234988, and you want to dial speed number 111 to reach an external number 15990234988 through the route.
- The [speed dial prefix](#) is enabled and set to *89.

Procedure

1. Log in to the PBX web interface, go to **Call Features > Speed Dial**, click **Add**.
2. In the **Speed Dial Number** field, enter 111.
3. In the **Phone Number** field, enter 15990234988.
4. Click **Save** and **Apply**.

Result

Dial *89111 on your phone to call the external number 15990234988.

Manage Speed Dial Numbers

This topic describes how to edit a speed dial number, or delete speed dial numbers.

Edit a speed dial number

1. Log in to the PBX web interface, go to **Call Features > Speed Dial**.
2. Click  beside the speed dial entry that you want to edit.
3. Change the **Speed Dial Number** or **Phone Number** according to your needs.
4. Click **Save** and **Apply**.

Delete speed dial numbers

You can delete a speed dial entry, or delete speed dial entries in bulk.

1. Log in to the PBX web interface, go to **Call Features > Speed Dial**.
2. To delete a speed dial number, do the following:
 - a. Click  beside the speed dial entry that you want to delete.
 - b. Click **OK** and **Apply**.
3. To delete speed dial numbers in bulk, do the following:
 - a. Select the checkboxes of the speed dial entries that you want to delete, click **Delete**.
 - b. Click **OK** and **Apply**.

Call Transfer

Call Transfer Overview

Call transfer is an in-call feature that allows the users to transfer current calls from their phones to another phone number or extension. This topic describes the call transfer types, and call transfer options.

Call transfer types

There are two scenarios to transfer a call:

- **Attended Transfer:** An attended transfer, also called consult transfer or warm transfer, allows the transferor to consult with the transfer recipient before transferring a call, such as the assistant can confirm with the executive whether he is free to answer the call before transferring the call.
- **Blind Transfer:** A blind transfer, also called cold transfer, allows the transferor to transfer a call to transfer recipient immediately without consultative communication, such as transfer a call to ring group.

Call transfer options

The following options are available for you to set up call transfer:

- **Feature code:** Extension users can use the call transfer code to transfer a call.

The default call transfer code:

Attended Transfer: *3

Blind Transfer: *03

- **Digit Timeout(s):** The timeout for transferor to enter the transfer recipient's number after dialing the feature code. The time interval between each digit should be within the digit timeout.
- **Attended Transfer Timeout(s):** The ring timeout for transfer recipient to take the transferring call.

If the transfer recipient does not answer the transferring call within the timeout, the system sends the call back to transferor.

Set up Call Transfer

This topic describes how to set up call transfer.

Set up attended transfer

1. Log in to the PBX web interface, go to **Call Features > Feature code > Call Transfer**.

2. Select the checkbox of **Attended Transfer** to enable the attended transfer feature.
If unselected, the extension users can not perform attended transfer by dialing the feature code.
3. Enter a code number according to your needs.
4. In the **Digit Timeout(s)** drop-down list, select a timeout for entering transfer recipient's number after you hear a dial tone.
5. In the **Attended Transfer Timeout(s)** field, enter a number of seconds for transfer recipient to take the transferring call.
6. Click **Save** and **Apply**.

Set up blind transfer

1. Log in to the PBX web interface, go to **Call Features > Feature code > Call Transfer**.
2. Select the checkbox of **Blind Transfer** to enable the blind transfer feature.
If unselected, the extension users can not perform blind transfer by dialing the feature code.
3. Enter a code number according to your needs.
4. In the **Digit Timeout(s)** drop-down list, select a timeout for entering transfer recipient's number after you hear a dial tone.
5. Click **Save** and **Apply**.

Perform an Attended Transfer

If you want to make sure someone is ready to take a transferred call or you need to explain something to the transfer recipient, you can perform an attended transfer. This topic describes how to perform an attended transfer.

Procedure

1. During a call, press the feature code of attended transfer (default *3).
The original call is placed on hold, and the system prompts "transfer" and the dial tone.
2. Dial the phone number of the contact where you want the call to be transferred.
3. Wait for the call to be answered.
When the call is answered, talk to the transfer recipient.
4. Hang up the call directly to complete the call transfer.
The original caller and the transfer recipient are connected.

Perform a Blind Transfer

If you do not need any interaction with the user who receives the call, you can perform a blind transfer. This topic describes how to perform a blind transfer.

Procedure

1. During a call, press the feature code of blind transfer (default *03).

The original call is placed on hold, and the system prompts "transfer" and the dial tone.

2. Dial the phone number of the contact where you want the call to be transferred.

The call ends automatically, and the transfer recipient's phone rings.

A new call between original caller and transfer recipient is established after transfer recipient answers.

Call Pickup

Call Pickup Overview

Call Pickup is a feature that allows employees to pick up colleagues' calls remotely, without having to walk to the his/her telephone. This topic describes the two pickup types including extension call pickup, group call pickup, and pickup code.

Extension call pickup

Extension call pickup, also known as directed call pickup, allows employees to pick up a call for a specific extension.

For example, the executive's phone is ringing, and the assistant knows the executive is in a meeting and is unavailable to answer the call, the assistant can pick up the executive's call from his/her phone.

Group call pickup

Group call pickup allows the [extension group](#) members to share their incoming calls. For a group of employees working on the same subject, when a member receives an incoming call and is unavailable to take the call, other members can pick up the call from their phones.

Pickup feature code

Extension users can use the pickup code to pick up a call.

The default pickup code:

- **Group Call Pickup:** *4
- **Extension Pickup:** *04

 **Tip:** You can change, enable, or disable the code on PBX web interface: **Call Features > Feature Code > Call Pickup.**

Pick up a Call for a Group Member

This topic describes how to pick up a call for a group member by feature code or by a programmable key.

Background information

The default feature code for picking up a group member's call is *4. You can change, enable, or disable the code on PBX web interface: **Call Features > Feature Code > Call Pickup > Group Call Pickup**.

Pick up a group call by feature code

When your extension group member receives a call, dial the Group Call Pickup feature code (default *4).

The called extension stops ringing and you are connected to the caller.

Pick up a group call by a programmable key

You can set a programmable key for users.

The following takes Yealink phone as an example to set a programmable key for group pickup.

Procedure

1. Log in to phone web interface, go to **DSSKey > Line Key**.
2. Set the programmable key as below:
 - **Type:** Select **Group Pickup**.
 - **Value:** Enter the feature code (*4).
 - **Label:** Optional. Set a label that you want to display on the phone screen.
 - **Line:** Select the line where your extension is registered.

Key	Type	Value	Label	Line	Extension
Line Key1	Group Pickup	*4		Line1	
Line Key2	Line			Line2	

3. Click **Confirm**.

Result

When an extension group member receives a call, the user can press the programmable key directly to answer the call.

Pick up a Call for a Specific Extension

This topic describes how to pick up a call for a specific extension.

Background information

The default feature code for picking up an extension call is *04. You can change, enable, or disable the code on PBX web interface: **Call Features > Feature Code > Call Pickup > Extension Pickup.**

Pick up a call by feature code

When there is an incoming call to a specific extension, dial the feature code (*04) followed by the extension number to pick up the call.

For example, extension 1001 receives an incoming call, dial *041001 to pick up the call.

Pick up a call by a BLF key

For the users who want to monitor call status changes of a specific extension, and pick up the call on their phone, you can set a BLF key for them by [auto provisioning](#).

Procedure

1. Log in to the phone web interface, go to **DSSKey > Line Key**.
2. Set the BLF key as below:
 - **Type:** Select **BLF**.
 - **Value:** Enter the monitored extension number.
 - **Label:** Optional. Set a label that you want to display on the phone screen.
 - **Line:** Select the line where your extension is registered.
 - **Extension:** Enter the extension pickup code (*04).

Key	Type	Value	Label	Line	Extension
Line Key1	BLF	1000		Line1	*04
Line Key2	Line			Line2	

3. Click **Confirm**.

Result

When the monitored extension receives an incoming call, the BLF key fast flashes red. The user can press the BLF key directly to answer the call.

Call Parking

Call Parking Overview

Call parking is a method of holding a call on a phone, anyone can retrieve the call on another phone. This topic describes what is call parking, parking number, parking types, parking recall, and parking code.

What is call parking

Traditionally, you can only retrieve the call on the same phone when you hold a call. Call parking allows you to hold a call on a parking number, and allows you to dial the parking number on any phone to retrieve the call.

Parking number

Parking number, also known as slot or orbit, is a 4-digit virtual extension number that the system assigns to the parked call. One parked call occupies one parking number.

The maximum number of simultaneous parking number is 100.

Parking types

Yeastar P-Series PBX System supports two parking types.

- **Call parking:** Park a call randomly on the first available parking number.
- **Directed call parking:** Park a call on the specified parking number.

Parking timeout destination

The parked call remains on the parking number for a specified period of time (default 60 seconds). If no one retrieves the parked call within the timeout period, the system routes the call to a designated destination (default initiator).

Parking feature code

Extension users can use the parking code to park a call.

The default parking code:

- **Call Parking:** *5
- **Directed Call Parking:** *05

 **Tip:** You can change, enable, or disable the code on PBX web interface: **Call Features > Feature Code > Call Parking.**

Directed Call Parking

This topic describes how to park a call on a specific parking number, and retrieve the parked call.

Background information

For sales or support, it probably doesn't matter exactly who picks up the call. You can allocate different parking numbers to different departments. For example, 6099 for salesmen, 6098 for support, and so on. The receptionist can park the call directly on the parking number based on business. Any one in the department can retrieve the call by the parking number.

 **Note:** The default range of parking number is from 6000 to 6099. The randomly call parking occupies parking number from 6000. To avoid that the allocated parking number is occupied by randomly call parking, we recommend that you allocate the parking number backwards from 6099.

Prerequisites

Make sure that the parking number is vacant. If the specified parking number is occupied, the system parks the call to the next available parking number.

 **Tip:** [Set up a function key for users to monitor the status of parking number.](#)

- For receptionist, he/she can press the function key to park the call to the parking number.
- For users in different departments, a parked call is visible on the function key, so that they can press the function key to retrieve the parked call easily.

Procedure

Parking number 6099 is assigned to salesmen. The receptionist receives a call, and the customer wants to consult business information.

1. The receptionist dials *056099 to park the call to parking number 6099.
2. The receptionist tells the salesmen there is a parked call for business.

If function keys are configured on the salesmen's IP phones, they will be notified.

3. The salesman who is available can dial 6099 or press the function key to retrieve the call.

 **Tip:** The default feature code for directed call park is *05. You can change, enable, or disable the code on PBX web interface: **Call Features > Feature Code > Call Parking > Directed Call Parking.**

Call Parking

This topic describes how to park a call randomly on the available parking number, and retrieve the parked call.

Background information

During a conversation, the employee may need to go to another office for retrieving an important file or for security, he/she can park the call, and to continue the conversation after arriving at the other office.

Procedure

1. Dial the feature code (*5) to park a call.

The system prompts you the parking number (6000) where the call is parked on.

2. Go to another office, dial the parking number (6000) to retrieve the parked call.

 **Tip:** The default feature code for call park is *5. You can change, enable, or disable the code on PBX web interface: **Call Features > Feature Code > Call Parking > Call Parking.**

Set up Parking Timeout Destination

By default, if a parked call is not retrieved after 60 seconds, the call will be transferred back to the originator. You can set up the parking timeout and timeout destination. This topic describes how to set up parking timeout and timeout destination for an unretrieved call.

Procedure

1. Log in to the PBX web interface, go to **Call Features > Feature Code > Call Parking.**
2. In the **Parking Timeout (s)** field, enter the number of seconds for the parked call.
3. In the **Timeout Destination** drop-down list, select a destination to receive the unretrieved call.

A parked call will be routed to the designated destination when the call parking times out.

- **Call Parking Initiator:** Route the call to the user who parks this call.
- **Extension:** Route the call to the designated extension number.
- **Extension Voicemail:** Route the call to the designated extension's voicemail.
- **External Number:** Route the call to the designated external number.

 **Note:** Set the **Prefix** according to your outbound route so that PBX can successfully route incoming calls to external number.

- # If the **Strip** of outbound route is not set, you don't have to set the **Prefix**.
- # If the **Strip** of outbound route is set, you need to set the **Prefix** according to the **Patterns** of outbound route.

4. Click **Save** and **Apply**.

Set up Parking Number

The default range of parking number is from 6000 to 6099. This topic describes how to define the range of parking numbers for parked call.

Procedure

1. Log in to PBX web interface, go to **Call Features > Feature code > Call Parking**.
2. In the **Parking Number Range** field, enter a number range for parked call.
3. Click **Save** and **Apply**.

 **Tip:** You can also change the parking number range at **PBX Settings > Preferences > Extension Preference > Parking Extension**.

Monitor a Parking Number on an IP Phone

This topic describes how to set up a function key on a user's phone to monitor a parking number.

Background information

For users who use directed call parking and want to monitor a specific parking number, you can set a function key for each user by [auto provisioning](#).

 **Note:** Users can also set function keys on their own IP phones. For more information, contact the phone manufacturer.

 **Tip:** Agents can also press the function keys to park or retrieve a call.

Procedure

1. Assign function keys for extension users to monitor parking number.
 - a. Log in to the PBX web interface, go to **Extension and Trunk > Extension**, edit the desired extension.
 - If you want to assign function keys for a specific extension user, click  beside the desired extension.
 - If you want to assign function keys for multiple extensions, select the checkboxes of the desired extensions, and click **Edit**.
 - b. Click the **Function Keys** tab.
 - c. Configure function keys.

 **Note:** The number of programmable keys varies by phone models. If the number of function keys you assign to an extension exceeds the number of programmable keys, the redundant function keys cannot take effect.

- **Type:** Select **Park & Retrieve**.

- **Value:** Select a parking number.
 - **Label:** Optional. Enter a value, which will be displayed on the phone screen.
- d. Click **Save**.
2. If the extension haven't be associated with a phone, see [Auto Provision IP Phones](#) to bind a phone with the extension.
 3. If the extension have been associated with a phone, reprovision the phone to take effect.
 - a. Go to **Auto Provisioning > Phones**.
 - b. Click  beside the phone assigned to this extension.

Result

The function key shows the real-time status of the parking number.

- **Green:** The parking number is idle.
The user can press the function key to park an active call to the idle parking number.
- **Red:** The parking number is occupied.
The user can press the function key to retrieve a parked call from the monitored parking number.

 **Note:** The key LED status may vary by phone models.

Fax

Fax Overview

Yeastar P-Series PBX System allows you to connect your fax machine to PBX system. Then you can send or receive faxes on a fax machine, and receive faxes by email. This topic describes how fax works with Yeastar P-Series PBX System, and introduces fax to email, fax detection, and Fax over VoIP settings.

How does fax work with PBX

The fax machines traditionally use the T.30 protocol to transmit analog data over Public Switched Telephone Network (PSTN). However, the analog data cannot be sent over an Voice over Internet Protocol (VoIP) network. Thus the T.38 protocol is created to provide reliable real-time faxing over IP (FoIP).

Yeastar P-Series PBX System supports both T.30 and T.38 protocols. With Yeastar P-Series PBX System, you can send or receive fax over PSTN or VoIP network in real time.

Faxing over PSTN (T.30)

T.30 protocol defines the procedures for transmitting data between two fax machines over the Public Switched Telephone Network (PSTN).

With S2 module or SO module installed on the PBX, you can connect the analog fax machine directly to the FXS port, and then send and receive fax on your fax machine.

Faxing over IP (T.38)

T.38 is a protocol for sending and receiving faxes over a VoIP network. Yeastar P-Series PBX System supports T.38.

The diagram below explains how to send fax over VoIP network.

1. A fax machine (T.30) sends a fax over PSTN to PBX (T.38).
2. The PBX (T.38) converts or encapsulates the T.30 protocol into T.38 data stream, and then sends the T.38 data stream to terminal PBX (T.38).
3. The terminal PBX (T.38) converts the T.38 data stream back to analog signal, and sends to terminal fax machine (T.30).

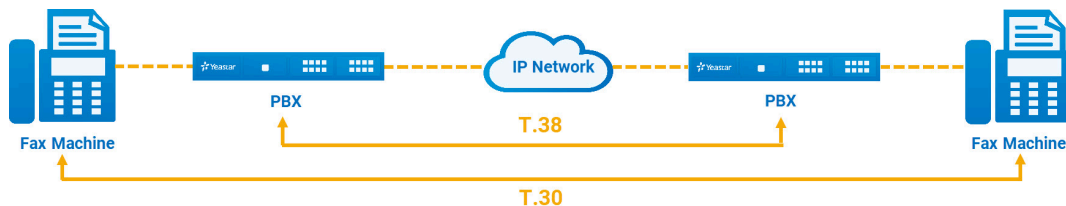

Fax to email

Faxes traditionally are sent directly to a fax machine; the recipient receives a printed copy. Yeastar P-Series PBX System provides fax to email feature that allows you to receive faxes as PDF by email.

The benefits of fax to email:

- Keep your faxes private without paper trail.
- Access faxes in real-time from anywhere.
- No need to pay for expensive hardware, printer paper, ongoing maintenance or a dedicated fax line.

Fax detection

Fax detection is used to detect automatically whether an incoming call is voice or fax. It is useful when you have fax call and voice call on the same line.

- If the PBX detects a fax signal, the PBX immediately routes the call to the designated fax destination.

- If the PBX does not detect a fax signal, the PBX handles the call as a regular voice call.

Fax over IP (FoIP) settings

The following settings are available when you want to improve the Fax transmission over VoIP network.

- **T.38 Support:** Enable or disable T.38 protocol for extension and trunk according to your needs.
- **T.38 Max BitRate:** The maximum bit rate of the fax transmission.
The default value is **14400**.
- **No T.38 Attributes in re-INVITE SDP:** Whether to contain T.38 attributes in SDP re-invite packet.
- **Error Correction Mode:** Error Correction Mode (ECM) is an optional transmission mode. ECM automatically detects and corrects errors in the fax transmission process that are sometimes caused by telephone line noise.

Send Faxes from an Analog Fax Machine

To send faxes from Yeastar P-Series PBX System, you need to set up an FXS extension for the fax machine and set up an outbound route for outgoing faxes. This topic describes the configurations for outgoing faxes on the PBX.

Prerequisites

Before you send faxes from an analog fax machine, perform the following tasks:

1. [Install S2 module or SO module on the PBX.](#)
2. Connect fax machine to FXS port of the PBX.

In this topic, we connect fax machine to FXS port located in Span2-Port3.

Step1. Assign an extension to the analog fax machine

1. Log in to the PBX web interface, go to **Extension and Trunk > Extension**, click **Add**.
2. In the **Basic** section, select **FXS Extension** from the **Extension Type** drop-down list.
3. In the **FXS Port** drop-down list, select the FXS port to which the fax machine is connected.

As the following figure shows, select fax port **Span2-Port3**.

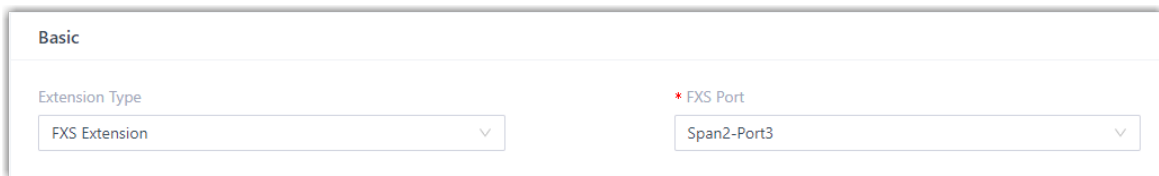

The screenshot shows a configuration form titled "Basic". It contains two dropdown menus. The first dropdown, labeled "Extension Type", has "FXS Extension" selected. The second dropdown, labeled "FXS Port" with a red asterisk, has "Span2-Port3" selected.

4. Leave other settings as default or change the settings according to your needs.

5. Click **Save** and **Apply**.

Step2. Set up an outbound route for sending faxes

1. Log in to the PBX web interface, go to **Call Control > Outbound Route**, click **Add**.
2. In the **Name** field, enter an outbound route name to help you identify it.
3. Set the [Dial Patterns](#) for the outbound route.

As the following figure shows, set **88.** for **Pattern**, and **2** for **Strip**.

Pattern	Strip	Prepend	Operations
88.	2		

+ Add

4. Select a trunk that supports to send faxes.

Note: If you choose a SIP trunk to send faxes, you need to [enable T.38 Support for this trunk](#).

As the following figure shows, select a trunk to send faxes.

20 items Available		1 item Selected	
Name	Trunk Type	Name	Trunk Type
<input type="checkbox"/> FXO2-4	FXO	<input type="checkbox"/> 5503301	FXO
<input type="checkbox"/> FXO2-6	FXO		
<input type="checkbox"/> FXO2-8	FXO		
<input type="checkbox"/> testsipdomain1	Register Trunk		
<input type="checkbox"/> testrealm11	Register Trunk		
<input type="checkbox"/> testiptables	Register Trunk		

5. Select the extension that you have assigned to fax machine.
6. Click **Save** and **Apply**.

Result

In the example shown above, you can dial 885503304 to send faxes to 5503304. After you hear a fax tone, you can start to send fax.

Receive Faxes through a Dedicated Trunk

Having an dedicated trunk for faxing is the best way to prevent interruptions and other problems that arise from using a shared trunk. This topic describes how to receive faxes on an analog fax machine through a dedicated trunk .

Prerequisites

Before you receive faxes by an analog fax machine, perform the following tasks:

1. [Install S2 module or SO module on the PBX.](#)
2. Connect fax machine to FXS port of the PBX.

In this topic, we connect fax machine to FXS port located in Span2-Port3.

Step1. Assign an extension to the fax machine

1. Log in to the PBX web interface, go to **Extension and Trunk > Extension**, click **Add**.
2. In the **Basic** section, select **FXS Extension** from the **Extension Type** drop-down list.
3. In the **FXS Port** drop-down list, select the FXS port to which the fax machine is connected.

As the following figure shows, select fax port **Span2-Port3**.

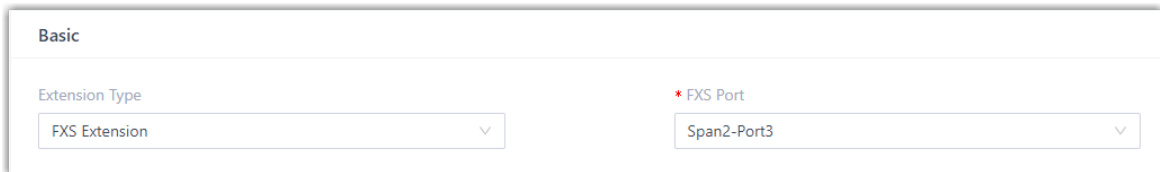

The screenshot shows a configuration form titled 'Basic'. It contains two dropdown menus. The first is labeled 'Extension Type' and has 'FXS Extension' selected. The second is labeled '* FXS Port' and has 'Span2-Port3' selected.

4. Click **Save** and **Apply**.

Step2. Set up an inbound route for receiving faxes

1. Go to **Call Control > Inbound Route**, click **Add**.
2. In the **Name** field, enter an inbound route name to help you identify it.
3. Set the **DID Pattern** that this route pass the incoming call through.

As the following figure shows, set the trunk number as DID pattern.

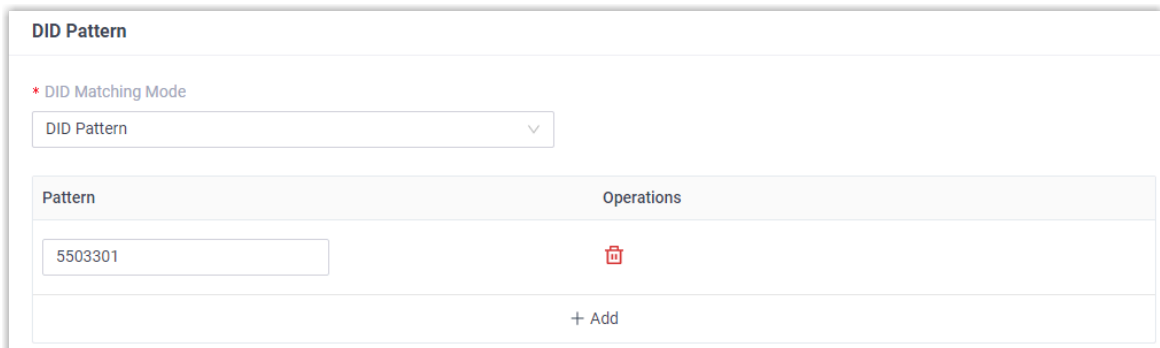

The screenshot shows a configuration form titled 'DID Pattern'. It contains a dropdown menu labeled '* DID Matching Mode' with 'DID Pattern' selected. Below this is a table with two columns: 'Pattern' and 'Operations'. The 'Pattern' column contains the value '5503301'. The 'Operations' column contains a trash icon. At the bottom of the table is a '+ Add' button.

4. Select the trunk that supports to receive faxes.

Note: If you choose a SIP trunk to receive faxes, you need to [enable T.38 Support for this trunk](#).

As the following figure shows, select a trunk to receive faxes.

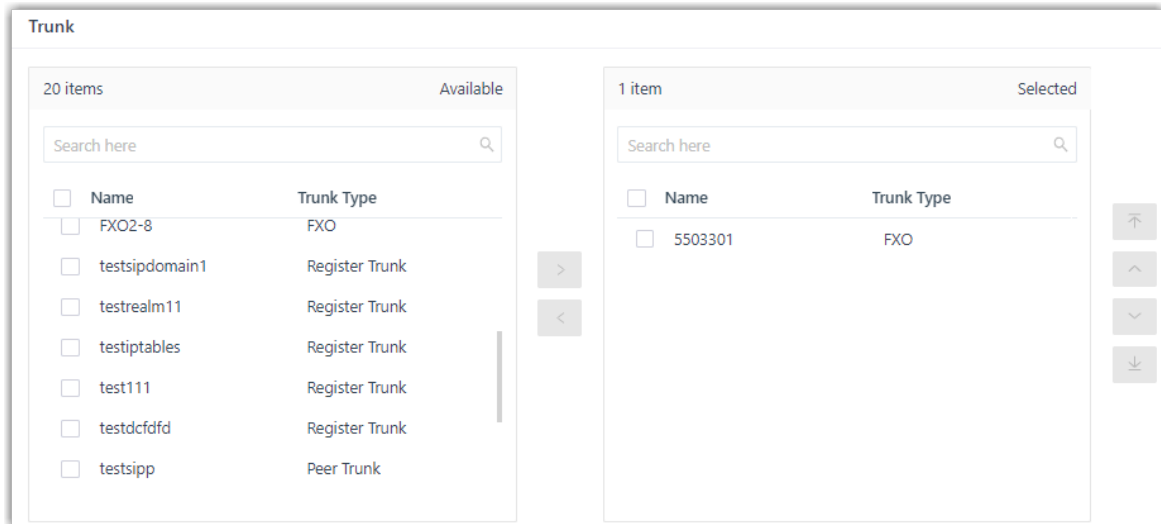

5. In the **Default Destination** drop-down list, select **Extension**.

6. Select the extension that you have assigned to fax machine.

7. Click **Save and Apply**.

Result

In the example shown above, when a customer sends faxes to trunk 5503301, you can receive the faxes on your analog fax machine.

Receive Faxes and Calls through the Same Line

If your company only has a single telephone line, you can have fax and voice call on the same line. This topic describes how to receive faxes on an analog fax machine through a shared line.

Background information

Generally, we use an IVR to receive fax and voice on the same line. When the call is answered, the PBX detects fax signal throughout the duration of the call.

Prerequisites

Before you receive faxes from an analog fax machine, perform the following tasks:

1. [Install S2 module or SO module on the PBX.](#)
2. Connect fax machine to FXS port of the PBX.

In this topic, we connect fax machine to FXS port located in Span2-Port3.

Step1. Assign an extension to the analog fax machine

1. Log in to the PBX web interface, go to **Extension and Trunk > Extension**.
2. Click **Add**.
3. In the **Basic** section, select **FXS Extension** from the **Extension Type** drop-down list.
4. In the **FXS Port** drop-down list, select the FXS port to which the fax machine is connected.

As the following figure shows, select fax port **Span2-Port3**.

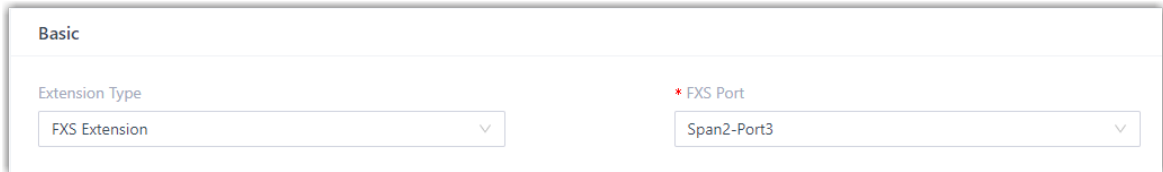

The screenshot shows the 'Basic' configuration section. It contains two dropdown menus: 'Extension Type' which is set to 'FXS Extension', and '* FXS Port' which is set to 'Span2-Port3'.

5. Click **Save** and **Apply**.

Step2. Set up an inbound route for receiving faxes

1. Go to **Call Control > Inbound Route**, click **Add**.
2. In the **Name** field, enter an inbound route name to help you identify it.
3. Set the **DID Pattern** that this route pass the incoming call through.

As the following image shows, set the trunk number as DID pattern.

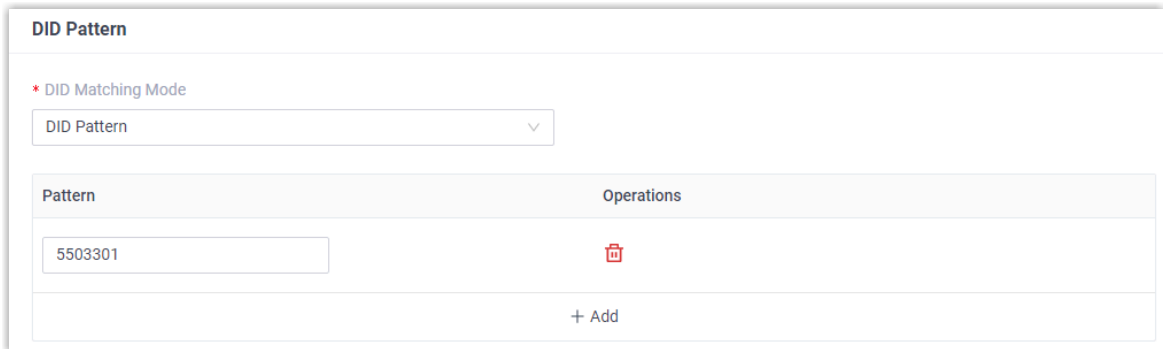

The screenshot shows the 'DID Pattern' configuration section. It includes a dropdown for '* DID Matching Mode' set to 'DID Pattern'. Below this is a table with two columns: 'Pattern' and 'Operations'. The 'Pattern' column contains the value '5503301', and the 'Operations' column contains a trash icon. At the bottom of the table is a '+ Add' button.

4. Select the trunk that supports to receive faxes.

Note: If you choose a SIP trunk to receive faxes, you need to [enable T.38 Support for this trunk](#).

5. In the **Default Destination** drop-down list, select **IVR**.
6. Set the destination for receiving the faxes.
 - a. Turn on **Fax Detection**.
 - b. In the **Fax Destination** drop-down list, select **Extension**.
 - c. Select the extension that you have assigned for fax machine.

As the following figure shows, set the assign extension 2185 to the fax machine.

7. Click **Save and Apply**.

Result

When the customer places a call to your company, the call is automatically answered by IVR. The customer can follow the voice menu to access the desired department, send fax after negotiation or send the fax directly.

1. The customer sends a fax to your company (5503301).
The originating fax machine sends a fax signal to system to indicate that this is a fax call.
2. The PBX detects the fax signal, automatically forwards the call to the extension (2185) you have assigned to your fax machine.
3. Receive fax on your fax machine.

Receive Faxes by Email

Yeastar P-Series PBX System provides fax to email feature that allows you to receive faxes as PDF by email. This topic describes how to receive faxes by email.

Prerequisites

- Make sure the PBX [system email](#) works, or the PBX cannot forward the received faxes to an extension user's email.
- Make sure there is a valid email address assigned to extension.
- **Optional:** Customize the fax [email template](#).

Procedure

1. Log in to the PBX web interface, go to **Call Control > Inbound Route**, edit the inbound route for incoming faxes.
2. If you receive faxes through a dedicated line, go to **Default Destination** section.
 - a. In the **Default Destination** drop-down list, select **Fax To Email**.
 - b. Select an extension user to receive faxes by email.

Default Destination

Default Destination *

Fax To Email 2171-2171

Time Condition

3. If you receive faxes through a shared line, go to **Fax Detection** section.
 - a. In the **Fax Destination** drop-down list, select **Fax To Email**.
 - b. In the **Extension's Email** drop-down list, select an extension user to receive faxes by email.

Default Destination

Default Destination *

IVR 6202-6202

Time Condition

Fax Detection

* Fax Destination * Extension's Email

Fax To Email 2185-2185

4. Click **Save** and **Apply**.

Result

When receiving a fax, PBX converts the received fax and simply forwards it to the email address as an PDF attachment.

Set up Fax over IP (FoIP)

Fax over IP (FoIP) is the process of using T.38 protocol to send a fax from a fax machine to another fax machine over the Internet. This topic describes how to enable T.38 for extension and trunk respectively, and how to change T.38 settings to improve the Fax transmission over VoIP network.

Enable T.38 protocol for SIP extension

If you want to register a SIP extension on a SIP compatible fax machine, you need to enable **T.38 Support** for this extension.

1. Log in to the PBX web interface, go to **Extension and Trunk > Extension**, edit the desired extension.
2. Go to **Advanced > VoIP Settings**.
3. Select the checkbox of **T.38 Support**.
4. Click **Save** and **Apply**.

Enable T.38 protocol for SIP trunk

If you want to use a SIP trunk to send or receive faxes, you need to enable **T.38 Support** for this trunk.

1. Log in to the PBX web interface, go to **Extension and Trunk > Trunk**, edit the desired trunk.
2. Go to **Advanced > VoIP Settings**.
3. Select the checkbox of **T.38 Support**.
4. Click **Save** and **Apply**.

Change T.38 settings

If the Fax over IP doesn't work, you can change the T.38 settings.

1. Log in to the PBX web interface, go to **PBX Settings > SIP Settings > T.38**.
2. Change the T.38 settings.
 - **T.38 Max BitRate**: Set the maximum bit rate of the fax transmission.
 - **No T.38 Attributes in re-INVITE SDP**: If enabled, SDP re-invite packet does not contain T.38 attributes.
 - **Error Correction Mode**: If enabled, after receiving the packet for a complete fax page, PBX notifies the transmitting fax machine of the frames with errors. The transmitting fax machine then retransmits the specified frames.

This process is repeated until all frames are received without errors.
3. Click **Save** and **Apply**.

Intercom

Intercom Call

Intercom is an instant inter-office communication with speakerphone mode enabled. This topic describes what is intercom, and shows you how to place an intercom call.

What is intercom

Intercom is a useful feature in an office environment to quickly connect with the operator or the secretary. With the Intercom feature you can create an instant connection to another user with the speakerphone enabled. There is no ringing on the side of the recipient, but his phone beeps to alert him about the connection. Schools, hospitals, offices, and more all frequently use intercom systems for efficient communication.

Background information

The default feature code for place an intercom call is *6. You can change, enable, or disable the code on PBX web interface: **Call Features > Feature Code > Intercom > Intercom**.

Place an intercom call

Dial the intercom feature code followed by the extension number to place an intercom call to this extension user.

For example, dial *61001 to place an intercom call to 1001.

The callee's phone plays a warning tone and automatically answers the call in speakerphone (hands-free) mode.

PBX System

System Preferences

This topic describes the preference settings that will be applied globally to Yeastar P-Series PBX System.

Go to **PBX Settings > Preferences** to configure preferences settings.

Basic preferences

Table 28.

Setting	Description
Device Name	Set a name for the PBX. The name will be used as the sender name when PBX sends emails out.
Name Display Format	Set display format for extension user's name and contact's name. <ul style="list-style-type: none">• First Name Last Name with Space Inbetween• Last Name First Name with Space Inbetween• Last Name First Name without Space Inbetween
Max Call Duration (s)	Set the global maximum call duration for an active call. When the call duration reaches the limit, the call will be ended. The default value is 10800 .  Note: For outbound calls, the Max Call Duration (s) setting of the caller's extension takes precedence.
FXO Mode	Select a mode to set the On Hook Speed, Ringer Impedance, Ringer Threshold, Current Limiting, TIP/RING voltage, adjustment, Minimum Operational Loop Current, and AC Impedance as pre-defined for your country's analog line characteristics.
Tone Region	Select your country or the nearest neighboring country to enable the default dial tone, busy tone, and ring tone.
Flash-Hook Event	Set which event will be triggered by pressing the hook flash. <ul style="list-style-type: none">• 3-Way Calling• Call Transfer
Virtual Ring Back Tone	If enabled, when the caller calls out via cellular trunk, the caller will hear the virtual ring back tone generated by the system before the callee answers the call.

DTMF preferences

Table 29.

Setting	Description
DTMF Passthrough	If enabled, PBX will pass DTMF tones directly to the other end without processing the DTMF tones.
DTMF Duration (ms)	Set the duration (in millisecond) of a DTMF tone on the FXO trunk. The default value is 120 .
DTMF Gap (ms)	Set the interval (in millisecond) between each DTMF tone on the FXO trunk. The default value is 120 .

Extension preferences

Below are default extension ranges. You can change the extension range according to your needs.

 **Note:** PBX treats IVR, Ring Group, Queue, and Conference as extensions. Extension users can dial extension numbers to reach them directly.

Table 30.

Setting	Description
User Extension	1000 - 5999
Parking Extension	6000 - 6099
IVR Extension	6200 - 6299
Ring Group Extension	6300 - 6399
Queue Extension	6400 - 6499
Conference Extension	6500 - 6599
Account Trunk	6700 - 6799

Voice Prompt

Voice Prompt Overview

This topic describes the definition, types, and preference settings of voice prompt on Yeastar P-Series PBX System.

What is a voice prompt

A voice prompt is a recorded audio message that is played to callers. The voice prompt can be a request that requires callers to input data through DTMF, or an intermediary that provides instructions and directions to help callers obtain information.

Voice prompt types

Yeastar P-Series PBX System supports 3 types of voice prompt:

- **System Prompt:** System prompt is Yeastar-provided prompt to provide instructions for callers. For example, if a password is required for a meeting, users will be prompted to enter password before they successfully join the meeting.

You can use pre-defined system prompt, or change system prompt by downloading online prompts or uploading custom system prompts.

For more information, see [Change System Prompt](#) and [Customize System Prompt](#).

- **Custom Prompt:** Custom prompt can be company-specific prompt, which is used in specific call scenario. For example, when a call is forwarded to another destination, the caller will be prompted that the call is forwarded.

You can record new prompt on your phone, or upload pre-recorded prompt to the PBX.

For more information, see [Record a Custom Prompt](#) and [Upload a Custom Prompt](#).

- **Music on Hold:** Music on Hold (MoH) is the business practice of playing recorded music to fill the silence that would be heard by callers who have been placed on hold.

You can use pre-defined music on hold, or create a playlist and upload audio files to the PBX.

For more information, see [Set up a Custom MoH Playlist](#).

Voice prompt preference settings

Navigation path: **PBX Settings > Voice Prompt > Prompt Preferences.**

Table 31.





Setting	Description
Music on Hold	The playlist to be played when a call is on hold.  Note: The available playlists are synchronized with playlists in Music on Hold .
Music on Hold for Call Forwarding	The music to be played when the caller is put on hold during call forwarding. <ul style="list-style-type: none">• Music on Hold: Play Music on Hold to the caller.• Ringing Tone: Play ringing tone to the caller.
Invalid Phone Number Prompt	The prompt to be played when a callee number is invalid.

Table 31. (continued)

Setting	Description
	 Note: The available prompts are synchronized with Custom Prompt .
Busy Line Prompt	The prompt to be played when a trunk is in use.  Note: The available prompts are synchronized with Custom Prompt .
Call Failure Prompt	The prompt to be played when a call is failed to be sent out.  Note: The available prompts are synchronized with Custom Prompt .
Event Notification Prompt	The prompt to be played when PBX places a call to notify callee that a specific event occurs.  Note: The available prompts are synchronized with Custom Prompt .
Play Call Forwarding Prompt	Whether to inform the user that the current call will be forwarded.

System Prompt



Change System Prompt

This topic describes how to download an online prompt and change it to the default system prompt.

Prerequisites

Make sure that Yeastar P-Series PBX System can access the Internet.

Procedure

1. Log in to the PBX web interface, go to **PBX Settings > Voice Prompt > System Prompt**.
2. Download the desired system prompt.
 - a. Click **Download Online Prompts**.
All the supported system prompts are displayed on **Download Online Prompts** page.
 - b. Select a prompt, click .
 - c. Click  to close the window.
The downloaded prompt is displayed on **System Prompt** list.
3. In the **Default** column, set the desired system prompt to default.
4. Click **Save** and **Apply**.

Result

The prompt is applied to the system.

Customize System Prompt

This topic describes how to customize system prompt and change it to the default prompt.

Background information

Yeastar P-Series PBX System provides [multiple online prompts](#) for your choice. If you want to use custom system prompt, you need to contact Yeastar Support to record your own prompt, and upload it to your PBX.

Prerequisites

- Contact Yeastar Support to record your own prompt.
- The prompt file must meet the following requirements:
 - # **File Type:** `.tar`
 - # **File Name:** Special characters are NOT allowed.
 - # **File Size:** Up to 100 MB

Procedure

1. Log in to the PBX web interface, go to **PBX Settings > Voice Prompt > System Prompt**.
2. Upload the custom system prompt.
 - a. Click **Upload System Prompts**.
 - b. In the pop-up window, select a `.tar` file from your local PC, click **Open**.

The uploaded prompt file is displayed on **System Prompt** list.
3. In the **Default** column, set the desired system prompt to default.
4. Click **Save** and **Apply**.

Result

The prompt is applied to the system.

Music on Hold

Set up a Custom MoH Playlist

Yeastar P-Series PBX System has a default playlist with built-in MoH files. This topic describes how to set up and use a custom MoH playlist.

Prerequisites

The audio files to be uploaded must meet the following requirements:

- **File format:** .wav Or .WAV



 **Tip:** If file format does not meet the requirement, you can [convert audio files via WavePad or G711 File Converter online](#).

- **File size:** Up to 8MB.
- **Supported wav format:**
 - # PCM 8K 16bit 128kbps
 - # A-law(g.711) 8k 8bit 64kbps
 - # u-law(g.711) 8k 8bit 64kbps

Step1. Add a custom MoH playlist

1. Log in to the PBX web interface, go to **PBX Settings > Voice Prompt > Music on Hold**.
2. Create a new playlist.
 - a. Click **Create New Playlist**.
 - b. In the pop-up window, configure the playlist.
 - **Playlist Name:** Enter a name to help you identify it.
 - **Play Order:** Decide whether to play the playlist alphabetically or randomly.
 - c. Click **Save**.
3. Add one or more audio files to the playlist.
 - a. Select the created playlist, click .
 - b. In the pop-up window, click **Upload**.
 - c. Choose the desired audio file, click **Open**.
 - d. **Optional:** To add more audio files, repeat **step b-c**.

The uploaded audio files are displayed on the **MoH Files** list.

4. **Optional:** Check sound quality and completeness of the audio files.
 - a. On **MoH Files** page, select the desired audio file, click .
 - b. In the pop-up window, set where to play the audio file.
 - In the **Play on Web** section, click  to play the audio file.
 - In the **Extension** drop-down list, select an extension and click **Play**.

PBX will call and play the audio file to the extension.
 - c. Click **OK**.
5. Click **Apply**.

Step2. Change the system MoH playlist

1. Click **Prompt Preferences** tab.
2. In the **Music on Hold** drop-down list, select the desired playlist.

3. Click **Save** and **Apply**.



Result

When a call is on held, the system will play audio files in the playlist to the waiting party.

Manage MoH Playlist and Audio Files





This topic describes how to edit or delete a MoH playlist, and manage MoH audio files.

Manage a MoH playlist

1. Log in to the PBX web interface, go to **PBX Settings > Voice Prompt > Music on Hold**.
2. Manage a MoH playlist.
 - To edit a MoH playlist, do as follows:
 - a. Select the desired playlist, click .
 - b. Edit the playlist according to your needs.
 - # **Playlist Name**: Change the playlist name.
 - # **Play Order**: Decide whether to play the playlist alphabetically or randomly.
 - c. Click **Save** and **Apply**.
 - To delete a MoH playlist, do as follows:
 - a. Select the desired playlist, click .
 - b. In the pop-up dialog box, click **OK**.
 - c. Click **Apply**.

If the deleted playlist is used for [Music on Hold](#) or [Music on Hold for Call Forwarding](#), the system will not play audio file to the waiting party who is put on hold during a call or call forwarding.

Manage MoH audio files

1. Log in to the PBX web interface, go to **PBX Settings > Voice Prompt > Music on Hold**.
2. Manage MoH audio files.
 - a. In the **Operations** column, click  beside the desired MoH playlist.
 - b. In the pop-up window, manage MoH audio files according to your needs.
 - To upload an audio file, click **Upload** and select the desired file.
 - To listen to an audio file, click , decide whether to play the audio file to an extension or on web.
 - To download an audio file, click .
 - To delete an audio file, click .

- c. Click **OK**.

Configure Call Forwarding Prompt

This topic describes how to configure call forwarding prompt.

Background information

Call forwarding prompt is used to prompt a caller that the call is forwarded to another destination. By default, when PBX is forwarding an incoming call to another number, the PBX will play the call forwarding prompt "please hold when I try to locate the person you are calling", and then play the MoH music. If you do not want the caller to find out that the call is being forwarded, you can disable **Play Call Forwarding Prompt**.

Procedure

1. Log in to the PBX web interface, go to **PBX Settings > Voice Prompt > Prompt Preferences**.
2. Unselect the checkbox of **Play Call Forwarding Prompt**.
3. **Optional:** To change MoH music, select **Music on Hold** or **Ringling Tone** from the drop-down list of **Music on Hold for Call Forwarding**.

 **Note:** The **Music on Hold** is the playlist that you have defined in **Music on Hold (PBX Settings > Voice Prompt > Prompt Preferences > Music on Hold)**.

4. Click **Save** and **Apply**.

Custom Prompt

Record a Custom Prompt

This topic describes how to record a custom prompt on a phone.

Prerequisites

At least one extension is ready for use.

Procedure

1. Log in to the PBX web interface, go to **PBX Settings > Voice Prompt > Custom Prompt**.
2. Record a custom prompt.
 - a. Click **Record New**.
A window pops up.
 - b. In the **Name** field, enter a name to help you identify the prompt.
 - c. In the **Extension** drop-down list, select an extension to record the prompt.

d. Click **Record**.

The system places a call to the selected extension. After you answer the call, you will hear a prompt for the recording.



e. Record your prompt on the phone.

When done, hang up or press the # key.

Result

Refresh the web page and click **Custom Prompt** tab.

The recorded prompt is displayed on the **Custom Prompt** page.

- To listen to the prompt, click .
- To change the voice content, click  to record again.

Upload a Custom Prompt

This topic describes how to upload a custom prompt.

Prerequisites

Prepare an audio file that meets the following requirements:

- **File format:** `.wav` or `.WAV`

 **Tip:** If the audio file does not meet the requirements, you can [convert the audio file via WavePad or G711 File Converter online](#).

- **File size:** Up to 8MB.
- **Supported wav format:**
 - # PCM 8K 16bit 128kbps
 - # A-law(g.711) 8k 8bit 64kbps
 - # u-law(g.711) 8k 8bit 64kbps

Procedure

1. Log in to the PBX web interface, go to **PBX Settings > Voice Prompt > Custom Prompt**.
2. Click **Upload**.
3. In the pop-up window, select an audio file from your local PC and click **Open**.





Result

The uploaded file is displayed on **Custom Prompt** page.

Manage Custom Prompts

This topic describes how to manage custom prompts, such as re-record, play, download, and delete a prompt.

Procedure

1. Log in to the PBX web interface, go to **PBX Settings > Voice Prompt > Custom Prompt**.
2. In the **Operations** column, manage custom prompts according to your needs.
 - To re-record a prompt, click , select an extension to record.
 - To listen to a prompt, click , decide whether to play the audio file to an extension or on web.
 - To download a prompt, click .
 - To delete a prompt, click , click **OK** and **Apply**.

Convert Audio Files

This topic describes how to convert audio files via WavePad or G711 File Converter online.

Background information

Audio files to be uploaded as MoH files or custom prompts must [meet the requirements](#). If your audio file does not meet the requirement, you can use audio editor to convert file format.

In this topic, we take the followings as examples to show you how to convert file format.

- [Convert Audio Files via WavePad](#)
- [Convert Audio Files Online](#)

Convert audio files via WavePad

To use WavePad to convert audio files to new formats, download [WavePad](#) to your local PC, and proceed as follows.

1. Launch WavePad, open your audio file.
2. Click **File > Save File As**.
3. Set the **Save as type** to `wave (*.wav)`, click **Save**.
4. Configure the encoder options according to the requirements of custom audio files and click **OK**.

Convert audio files online

If you don't want to download an app, you can quickly convert your audio files via G711 File Converter online.

1. Go to g711.org.
2. Click **Browse** to upload your audio file.
3. Set the **Output Format**.

 **Note:** We recommend that you choose **u-law** or **Standard Definition WAV**.

4. Click **Submit** to start converting the file.

Audio Files Requirements

This topic describes the requirements for audio files to be uploaded to Yeastar P-Series PBX System.

Applications of audio files

You may need to upload a custom audio file in the following scenarios:

- Voicemail greetings
- Custom prompt
- Music on hold

Audio file requirements

Audio files to be uploaded to the PBX must meet the following requirements:

Option	Requirement
File Name	Should NOT contain special characters.
File Size	Up to 8MB.
File Format	<p><code>.WAV</code> OR <code>.wav</code> file.</p> <ul style="list-style-type: none"> • PCM, 8K, 16bit, 128kbps • A-law (g.711), 8k, 8bit, 64kbps • u-law (g.711), 8k, 8bit, 64kbps

SIP Settings

This topic describes the SIP settings on the Yeastar P-Series PBX System for reference.

The SIP configurations require professional knowledge of SIP protocol, incorrect configuration may cause calling issues on the SIP extensions and SIP trunks.

Go to **PBX Settings > SIP Settings** to configure SIP settings.

SIP general settings

Table 32.





Setting	Description
Basic Settings	
SIP UDP Port	<p>UDP Port used for SIP registration. The default value is 5060.</p> <p> Note: If you change the port, the extensions that use UDP protocol must re-register to the new port.</p>
SIP TCP Port	<p>TCP Port used for SIP registration. The default value is 5060.</p> <p>To change the port, select the checkbox of SIP TCP Port and set the port.</p> <p> Note: If you change the port, the extensions that use TCP protocol must re-register to the new port.</p>
RTP Port Range	<p>RTP port for transmitting data. The default range is 10000-12000.</p> <p> Note:</p> <ul style="list-style-type: none"> • The From-port value should be greater than 10000. • The From-port and the To-port should have a difference value between 100 and 10000.
Outbound SIP Port Range	<p>To prevent from being blocked by carrier due to overloaded calls and subscriptions, you can specify an outbound SIP port range. PBX will select a port from the range to register to the carrier. The default range is 5062-5082.</p> <p>To change the port, select the checkbox of Outbound SIP Port Range and set the port.</p>
SIP Endpoint Registration Timer	
Max Registration Time (s)	Maximum duration (in seconds) of incoming registrations and subscriptions.
Min Registration Time (s)	Minimum duration (in seconds) of incoming registrations and subscriptions.
Qualify Frequency (s)	How often to send SIP OPTIONS packet to SIP device to check if the device is up.
Outbound SIP Registration Timer	
Registration Attempts	The number of registration attempts before giving up (0 indicates no limit).
Default Registration Time(s)	<p>Default registration duration (in seconds).</p> <p> Note: The actual duration needs to subtract 10 seconds from the value you fill in.</p>
SIP Endpoint Subscription Timer	

Table 32. (continued)

Setting	Description
Max Subscription Time(s)	Maximum duration (in seconds) of incoming subscriptions.
Min Subscription Time(s)	Minimum duration (in seconds) of incoming subscriptions.

SIP codec

A codec is a compression or decompression algorithm used in the transmission of voice packets over a network or the Internet.

Table 33.

Setting	Description
iLBC Mode	<p>The iLBC codec supports the following modes:</p> <ul style="list-style-type: none"> • 20 ms • 30 ms <p>To get better voice quality, you need to set the iLBC mode according to your SIP endpoints.</p>
Codec Selection	<p>Select the codec.</p> <p>Available values: u-law, a-law, GSM, H264, VP8, H263, H263P, iLBC, G722, G726, SPEEX, ADPCM, G729A, MPEG4</p> <p> Note:</p> <ul style="list-style-type: none"> • To ensure that users can have audio calls on Linkus Web Client, you must enable at least any one of u-law, a-law, or G722. • To ensure that users can have video calls on Linkus Web Client after you subscribe Yeastar P-Series Ultimate Plan, you must enable either VP8 or H264. We recommend that you enable VP8 or set VP8 to a higher priority.

TLS settings

Setting	Description
TLS	Enable or disable TLS.
SIP TLS Port	TLS port used for SIP registration. The default value is 5061 .
When PBX acting as a Sever	
TLS Certificate	Upload a server certificate when PBX acts as a server.
TLS Verify Client	<p>Verify client certificate when PBX acts as a server.</p> <p> Note: If enabled, you need to upload a client certificate to the PBX and TLS client.</p>

Setting	Description
When PBX acting as a Client	
TLS Connection Method	Specify a protocol for outbound client connections. <ul style="list-style-type: none"> • TLS V1.0 • TLS V1.2
TLS Verify Server	Verify server certificate when PBX acts as a client. <p> Note: If enabled, you need to upload a server certificate to the PBX.</p>

Session Timer

A periodic refreshing of a SIP session that allows both user agent and proxy to determine if the SIP session is still active.

Setting	Description
Session Timer	Select a session timer mode. <ul style="list-style-type: none"> • No: Do not include “timer” value in any field. • Supported: Include “timer” value in Supported header. • Required: Include “timer” value in Required header. • Forced: Include “timer” value in both Supported and Required header.
Session-Expires (s)	The max refresh interval in seconds.
Min-SE (s)	The min refresh interval in seconds. The value should not be smaller than 90.

QoS

Quality of Service (QoS) is a major issue in VoIP implementations. The issue is how to guarantee that packet traffic for a voice or other media connection will not be delayed or dropped due to interference from other traffic of lower priority.

When the network capacity is insufficient, QoS can provide users with priority by setting the value.

Setting	Description
ToS (Type of Service)	
ToS SIP	Type of Service for SIP packets.
ToS Audio	Type of Service for RTP audio packets.
ToS Video	Type of Service for RTP video packets.
CoS (Class of Service)	
Cos SIP	Class of Service for SIP packets.
Cos Audio	Class of Service for RTP audio packets.

Setting	Description
Cos Video	Class of Service for RTP video packets.

T.38

Adjust T.38 settings if T.38 Fax doesn't work.

Setting	Description
T.38 Max BitRate	Adjust the max BitRate for T.38 fax.
No T.38 Attributes in re-INVITE SDP	If enabled, SDP re-invite packet will not contain T.38 attributes.
Error Correction Mode	Enable or disable Error Correction for the fax.

Advanced SIP settings

Setting	Description
Incoming Caller ID/DID Retrieval	
Get Caller ID From	Decide the system will retrieve Caller ID from which header field. <ul style="list-style-type: none"> • From • Contact • Remote-Party-ID • P-Asserted-Identity • P-Preferred-Identity
Get DID From	Decide the system will retrieve DID from which header field. <ul style="list-style-type: none"> • To • Invite • Diversion • Remote-Party-ID • P-Asserted-Identity • P-Preferred-Identity • P-Called-Party-ID <p> Note: If Remote-Party-ID is selected but the SIP trunk doesn't support this, the system will retrieve DID from Invite header.</p>
SIP Request Header	
User Agent	Set the user agent that will be included when sending SIP packages out.
Other Options	
Allow Guest	If enabled, PBX will accept unknown calls.
Support Message Request	Whether to support SIP Message Request or not.

Setting	Description
Inband Progress	<p>Whether to enable inband progress or not. The Inband Progress setting applies to all the extensions.</p> <p> Note: To configure global Inband Progress setting, you need to contact Yeastar support to configure a custom configuration file.</p> <ul style="list-style-type: none"> • Check this option: PBX will send a 183 Session Progress to the extension when told to indicate ringing and immediately start sending ringing as audio. • Uncheck this option: PBX will send a 180 Ringing to the extension when told to indicate ringing, but will NOT send it as audio.

Jitter Buffer

Jitter Buffer Overview

This topic describes what is and when to use jitter buffer, and introduces two jitter buffer types supported on Yeastar P-Series PBX System.

What is jitter buffer

Jitter is a variation between the time that voice packets are sent and received. For example, two packets may arrive at the same time, or out of order due to network congestion, which can cause the problem of audio quality. In this case, jitter buffer can be used to arrange packets according to their expected timing values.

Jitter buffer types

Yeastar P-Series PBX System supports two types of jitter buffer:

- **Fixed jitter buffer:** The fixed jitter buffer has a fixed size and the packets leaving the jitter buffer have a constant delay.
- **Adaptive jitter buffer:** Adapting to network's delay, the adaptive jitter buffer has a variable size and the packets leaving the jitter buffer have a variable delay.

When to use jitter buffer

If you have networking issues like packet loss or packets arriving out of order, you can enable jitter buffer to improve call quality.

Packets loss

If the packets are partially lost, the jitter buffer inserts the lost frame and passes them on in an evenly spaced continuous stream.

Packets arriving out of order

If the arriving packets are out of order, the jitter buffer inserts the packets into the buffer in the correct order, and passes them on in the expected order.

For more information of jitter buffer configuration, see [Configure Jitter Buffer](#).

Configure Jitter Buffer

This topic describes how to configure jitter buffer on Yeastar P-Series PBX System.

Background information

If you have networking issues like [packet loss](#) or [packets arriving out of order](#), you can enable jitter buffer to improve call quality.

Procedure

1. Log in to the PBX web interface, go to **PBX Settings > Jitter Buffer**.
2. Enable **Jitter Buffer**.
3. To enable jitter buffer for trunks, select the desired trunks from **Available** box to **Selected** box.

The outbound audio through the selected trunk will be dejittered on the other side.

4. To enable jitter buffer for extensions, select the desired extensions from **Available** box to **Selected** box.

The received audio on the selected extensions will be dejittered.



Note: Jitter buffer doesn't work in the following situations:

- In an internal call, the audio is received from an analog phone.
 - In an external call, the other side sends audio through a non-SIP trunk, and jitter buffer is not enabled for the trunk.
5. In the **Implementation** drop-down list, select the implementation of jitter buffer.
 - **Adaptive:** Adapting to network's delay, the adaptive jitter buffer has a variable size and the packets leaving the jitter buffer have a variable delay. If you choose the option, specify the adjustment size and the max jitter buffer size as follows.
 - # **Adaptive Adjustment Size (ms):** The size of each adaptive adjustment of jitter buffer. The default value is 50. If you retain the default value, the jitter buffer size will be adjusted dynamically based on current network condition. It will start from 0 ms and grow at a size of 50 ms each time.
 - # **Max Jitter Buffer Size (ms):** The maximum value of adaptive jitter buffer. The default value is 200.
 - **Fixed:** The fixed jitter buffer has a fixed size and the packets leaving the jitter buffer have a constant delay.

If you choose the option, enter a value in the **Jitter Buffer Size (ms)** field. The default value is 200.
 6. Click **Save** and **Apply**.

Network

Basic Network

Basic Network Overview

This topic describes the network modes in Yeastar P-Series PBX System.

Ethernet modes

Yeastar P-Series PBX System provides LAN interface and WAN interface. By default, the LAN interface is enabled, and the WAN interface is disabled. You can configure the following Ethernet modes for the system:

- **Single:** Only LAN port is used for connection, WAN port is disabled.
- **Bridge:** LAN port is used for connection. WAN port will be used as bridge for PC connection.
- **Dual:** Both LAN port and WAN port are used for connection.
If you use **Dual** mode, you need to specify a default network interface for the PBX.

 **Note:** The traffic will be routed to the default interface, you need to [add a static route](#) to override the default route entries, routing the traffic from a specific IP address to the specified destination.

IP address assignment

Yeastar P-Series PBX System supports three types of IP address assignment:

- **Assign a static IP address**

Contact your network administrator to assign an IP address to the PBX. Then you need to manually configure settings such as the IP address, subnet mask, default gateway, and DNS servers on the PBX.

- **Obtain an IP address from a DHCP server**

You can configure the PBX to automatically obtain an IP address when it starts up from a DHCP server running in your network.

 **Note:** The IP address assigned to the PBX may vary every time the PBX is started up.

- **Obtain an IP address from a PPPoE client**

You can connect the PBX to a PPPoE client, and set up a PPPoE connection on the PBX to get an IP address.

 **Note:** The IP address assigned to the PBX may vary every time the PPPoE is started up.

Configure a Static IP Address

This topic describes how to a static IP address to Yeastar P-Series PBX System.

Background information

The default IP address of Yeastar P-Series PBX System is 192.168.5.150. According to your network environment, you may need to change the IP address to the same network segment of your local network.

The following instructions assume that you need to use LAN port of Yeastar P-Series PBX System to send and receive network traffic. The IP information is as below:

- IP address: 192.168.6.124
- Subnet mask: 255.255.255.0
- Gateway address: 192.168.6.1
- DNS server: 192.168.1.1

Prerequisites

- PBX and PC are connected to the same local network.
- Your PC has ability to access the default network segment 192.168.5.X of the PBX.

 **Tip:** To access the PBX, you need to change your PC to the same network segment of the PBX.

Procedure

1. Log in to the PBX web interface, go to **System > Network > Basic Settings**.
2. In the **Basic** section, configure the following settings:

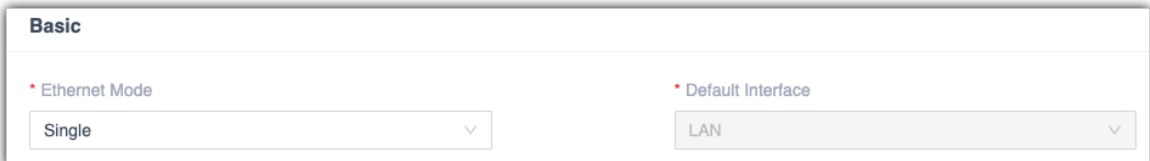

The screenshot shows the 'Basic' configuration page. It features two dropdown menus: 'Ethernet Mode' with 'Single' selected, and 'Default Interface' with 'LAN' selected. Both dropdowns have a downward arrow on the right side.

- **Ethernet Mode:** Select the Ethernet mode. In this scenario, select **Single**.
 - # **Single:** Only the LAN port is used for up-link connection.
 - # **Dual:** Both LAN and WAN are used for up-link connection.

 **Note:** The traffic will be routed to the default interface; you may need to [add a static route](#) to override the default route entries, routing the traffic from a specific IP address to the specified destination.

- # **Bridge:** LAN port is used for up-link connection. WAN port can be used as a bridge to connect other device.
- **Default Interface:** Optional. Select a default interface if you select **Dual** mode.

3. In the **LAN** section, select **Static IP Address**, and enter the network information for LAN port.

The screenshot shows the LAN configuration interface. At the top, there are three radio buttons: DHCP, Static IP Address (which is selected and highlighted with a yellow box), and PPPoE. Below this, there are several input fields arranged in two columns. The left column contains fields for IP Address (192.168.6.124), Gateway (192.168.6.1), Preferred DNS Server (192.168.1.1), and IP Address 2. The right column contains fields for Subnet Mask (255.255.255.0), Alternative DNS Server, and Subnet Mask 2.

- **IP Address:** Enter the IP address that is assigned to the PBX.
- **Subnet Mask:** Enter the subnet mask.
- **Gateway:** Enter the gateway address.
- **Preferred DNS Server:** Enter the IP address of preferred DNS server.
- **Alternative DNS Server:** Optional. Enter the IP address of alternative DNS server.
- **IP Address 2:** Optional. Enter a second IP address for the PBX.

 **Note:** According to your network environment, you may need to set another IP address to allow users in different IP segment to access the PBX.

- **Subnet Mask 2:** Optional. Enter another subnet mask for the second IP address.

4. Click **Save** and reboot the PBX to take effect.

Result

After the PBX reboots, the PBX's IP is changed to 192.168.6.124.

What to do next

To access the PBX, change your PC's IP to the same network segment of the PBX, for example, 192.168.6.110.

Obtain an IP Address from a DHCP Server

This topic describes how to can configure Yeastar P-Series PBX System to automatically obtain an IP address from a DHCP server running in your network.

Background information

If you choose this method to configure IP address for the PBX, the IP address assigned to the PBX may vary every time the PBX is started up. We suggest that you configure a static IP address for the PBX. For more information, see [Configure a Static IP Address](#).

The following instructions assume that you connect an Ethernet cable to LAN port of Yeastar P-Series PBX System and need to obtain an IP address from the local DHCP server.

Prerequisites

- DHCP feature is enabled on your router.
- Only one DHCP server in the local network, or the PBX cannot get the IP address.

Procedure

1. Log in to the PBX web interface, go to **System > Network > Basic Settings**.
2. In the **Basic** section, configure the following settings:

The screenshot shows the 'Basic' configuration section. It contains two dropdown menus: 'Ethernet Mode' with 'Single' selected, and 'Default Interface' with 'LAN' selected.

- **Ethernet Mode:** Select the Ethernet mode. In this scenario, select **Single**.
 - # **Single:** Only the LAN port will be used for up-link connection.
 - # **Dual:** Both LAN and WAN can be used for up-link connection.

Note: The traffic will be routed to the default interface; you may need to [add a static route](#) to override the default route entries, routing the traffic from a specific IP address to the specified destination.

- # **Bridge:** LAN port will be used for up-link connection. WAN port can be used as a bridge to connect other device.

- **Default Interface:** Select a default interface if you select **Dual** mode.

3. In the **LAN** section, select **DHCP**.

The screenshot shows the 'LAN' configuration section. At the top, there are three radio buttons: 'DHCP' (selected and highlighted with a yellow box), 'Static IP Address', and 'PPPoE'. Below these are three checkboxes: 'Enable VLAN', 'Enable VLAN Subinterface 1', and 'Enable VLAN Subinterface 2', all of which are currently unchecked.

4. Click **Save** and reboot the PBX to take effect.

Result

The PBX's IP address will obtain a new IP address from the DHCP server in your local network.

You need to log in to the web interface of your router, and check which IP address is assigned to the PBX.

Configure a PPPoE Connection

This topic describes how to configure a PPPoE connection on Yeastar P-Series PBX System to obtain an IP address when the PBX is in Dual network mode.

Background information

A PPPoE client assigns a dynamic IP address to the PBX, the IP address of the PBX may vary every time the PBX is started up. In this case, you need to configure dual network, and configure a static IP address on the PBX to ensure that you can always access the PBX.

The following instructions assume that you need to connect LAN port to local network, connect WAN port to PPPoE. The network information is as the following:

LAN	WAN
Static IP <ul style="list-style-type: none"> • IP address: 192.168.6.124 • Gateway address: 192.168.6.1 • Subnet mask: 255.255.255.0 • DNS: 192.168.1.1 	PPPoE <ul style="list-style-type: none"> • Username: 059219383822 • Password: 19283772

Procedure

1. Log in to the PBX web interface, go to **System > Network > Basic Settings**.
2. In the **Basic** section, configure the following settings:
 - **Ethernet Mode:** Select the Ethernet mode. In this scenario, select **Dual**.
 - # **Single:** Only the LAN port will be used for up-link connection.
 - # **Dual:** Both LAN and WAN can be used for up-link connection.

 **Note:** The traffic will be routed to the default interface; you may need to [add a static route](#) to override the default route entries, routing the traffic from a specific IP address to the specified destination.

Bridge: LAN port will be used for up-link connection. WAN port can be used as a bridge to connect other device.

- **Default Interface:** Select the port where PPPoE is connected. In the scenario, select **WAN**.

3. In the **LAN** section, select **Static IP Address**, and enter the network information for LAN port.

The screenshot shows the LAN configuration interface. At the top, there are three radio buttons: DHCP (unselected), Static IP Address (selected), and PPPoE (unselected). Below this, there are several input fields:

- * IP Address:** 192.168.6.124
- * Subnet Mask:** 255.255.255.0
- * Gateway:** 192.168.6.1
- * Preferred DNS Server:** 192.168.1.1
- Alternative DNS Server:** (empty field)
- IP Address 2:** (empty field)
- Subnet Mask 2:** (empty field)

- **IP Address:** Enter the IP address that is assigned to the PBX.
- **Subnet Mask:** Enter the subnet mask.
- **Gateway:** Enter the gateway address.
- **Preferred DNS Server:** Enter the IP address of preferred DNS server.
- **Alternative DNS Server:** Optional. Enter the IP address of alternative DNS server.
- **IP Address 2:** Optional. Enter a second IP address for the PBX.

 **Note:** According to your network environment, you may need to set another IP address to allow users in different IP segment to access the PBX.

- **Subnet Mask 2:** Optional. Enter another subnet mask for the second IP address.

4. In the **WAN** section, select **PPPoE** and enter the **Username** and **Password**.

The screenshot shows the WAN configuration interface. At the top, there are three radio buttons: DHCP (unselected), Static IP Address (unselected), and PPPoE (selected). Below this, there are two input fields:

- * Username:** 059219383822
- * Password:** 19283772

5. Click **Save** and reboot the PBX to take effect.

Result

Both LAN and WAN are set up for the PBX.

- All network traffic will be sent and received by the WAN port (default network interface).

- You can access the PBX web interface by the LAN IP address to configure the PBX settings.

What to do next

If you want to route network traffic through LAN port, you need to add static routes on the PBX. For more information, see [Add a Static Route](#).

Configure a VLAN on Yeastar P-Series PBX System

This topic describes how to configure a VLAN on Yeastar P-Series PBX System.

Background information

VLAN allows you to segment out a physical network into virtual networks with different subnets. For example, one network is used by one department and another network is used by another department.

VLAN feature on the Yeastar P-Series PBX System is used to filter network traffic. Only the devices that have the same VLAN ID can communicate with the PBX. You can set up VLAN on LAN interface or WAN interface. To allow network traffic from multiple subnets, you can add VLAN sub interfaces on the PBX.

- [Configure a VLAN for LAN/WAN port](#)
- [Add a VLAN subinterface](#)

Configure a VLAN for a network interface

The following instructions assume that you need to set a VLAN for LAN port, and the network information of the LAN port is as the following. You want to restrict that only the devices with VLAN ID 100 can communicate with the PBX.

- IP address: 192.168.6.124
- Gateway address: 192.168.6.1
- Subnet mask: 255.255.255.0

Procedure

1. Log in the PBX web interface, go to **System > Network > Basic Settings**.
2. Configure the Ethernet port that needs to set up a VLAN.

In the scenario, configure LAN port.

- a. In the **LAN** section, select the checkbox of **Enable VLAN**.
- b. In the **VLAN ID** field, enter an ID for the PBX. In this example, enter *100*.

Note: The devices that need to communicate with the PBX should have the same VLAN ID.

- c. In the drop-down list of **VLAN Priority**, select the priority value that is associated with the VLAN ID.

The priority value is between 0 to 7. 7 has the highest priority.

3. Click **Save** and reboot the PBX to take effect.

Result

Only the device that is in the same local network segment 192.168.6.X and has the same VLAN ID 100 can communicate with the PBX.

Add a VLAN subinterface

A VLAN subinterface is a virtual interface created by dividing one physical Ethernet interface (LAN or WAN) into multiple logical interfaces.

If the PBX has only one physical Ethernet interface, but needs route traffic via two different subnets, you can configure VLAN for the main interface (LAN or WAN) and add a VLAN subinterface with a different subnet.

The following instructions assume that you need to add a VLAN subinterface for LAN interface.

- **Main interface (LAN):** For network traffic in subnet 192.168.6.0/24 with VLAN ID 100.
- **Sub interface:** For network traffic in subnet 192.168.5.0/24 with VLAN ID 105.

Procedure

1. Log in the PBX web interface, go to **System > Network > Basic Settings**.
2. Configure the Ethernet port that needs to set up a VLAN.
 - a. In the **LAN** section, select the checkbox of **Enable VLAN**.

- b. In the **VLAN ID** field, enter an ID for the PBX. In this example, enter *100*.

 **Note:** The devices that need to communicate with the PBX should have the same VLAN ID.

- c. In the drop-down list of **VLAN Priority**, select the priority value that is associated with the VLAN ID.

The priority value is between *0* to *7*. *7* has the highest priority.

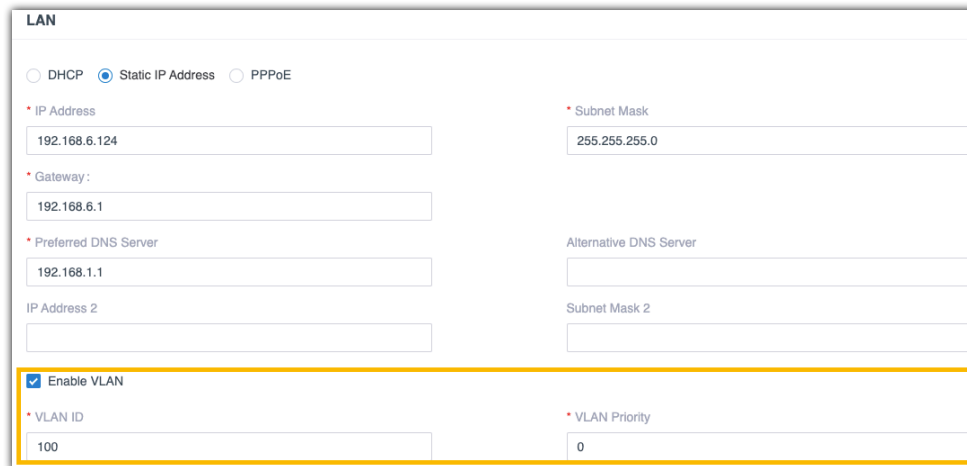

LAN

DHCP Static IP Address PPPoE

* IP Address: 192.168.6.124

* Subnet Mask: 255.255.255.0

* Gateway: 192.168.6.1

* Preferred DNS Server: 192.168.1.1

Alternative DNS Server:

IP Address 2:

Subnet Mask 2:

Enable VLAN

* VLAN ID: 100

* VLAN Priority: 0

3. In the **LAN** section, select the checkbox of **Enable VLAN Subinterface 1** and configure the following settings.
- **IP Address:** Assign an IP address that is in the subnet 192.168.5.0/24, for example, *192.168.5.20*
 - **Subnet Mask:** Enter the subnet mask. In this scenario, enter *255.255.255.0*.
 - **VLAN ID:** Assign a VLAN ID for the sub interface, for example, enter *105*.
 - **VLAN Priority:** Set a priority for the VLAN ID, for example, enter *0*.

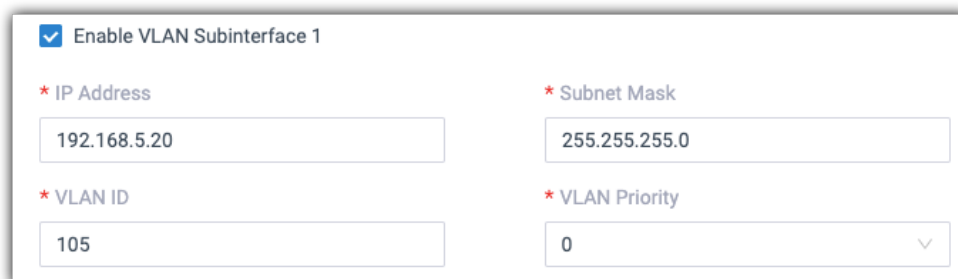

Enable VLAN Subinterface 1

* IP Address: 192.168.5.20

* Subnet Mask: 255.255.255.0

* VLAN ID: 105

* VLAN Priority: 0

4. Click **Save** and reboot the PBX to take effect.

Result

- The network traffic from subnet 192.168.6.0/24 and has VLAN ID 100 will be routed to the PBX VLAN interface.
- The network traffic from subnet 192.168.5.0/24 and has VLAN ID 105 will be routed to the VLAN sub interface.

Web Server

Change Web Server Protocol and Port

This topic describes how to change the web protocol and port of Yeastar P-Series PBX System.

Background information

By default, the PBX uses HTTPS 8088 port for web service, and allows redirecting from HTTP 80 port.

When you need to access the PBX web interface, you can type one of the following URLs:

- `https://{pbx_ip}:8088`
For example, `https://192.168.5.150:8088`
- `http://{pbx_ip}`
For example, `http:192.168.5.150`

Procedure

1. Log in to the PBX web interface, go to **System > Network > Web Server**.
2. In the **Protocol** section, complete the following configurations:
 - a. In the drop-down list of **Protocol**, select a protocol.
 - b. If **HTTPS** is selected, configure the following settings:
 - **HTTPS Port**: Enter a HTTPS port.
 - **HTTPS Certificate**: Select the default certificate or upload your own certificate.
 - **Redirect from HTTP 80 port**: Decide whether to allow requests to HTTP port 80.

If the option is enabled, the requests to HTTP port 80 will be redirected to the respective HTTPS service.
 - c. If **HTTP** is selected, enter the HTTP port in the **HTTP Port** field.
3. Click **Save** and **Apply**.

Result

The next time, you need access the PBX web interface by the configured protocol and port.

Change Automatic Logout Time

For security purposes, Yeastar P-Series PBX System automatically logs out a user session after 15 minutes if no operation is performed on the web page. You can change this session logout period.

Prerequisites

Automatic Logout feature is only for the super administrator. The system will not automatically log out an extension user from web client.

Procedure

1. Log in to the PBX web interface, go to **System > Network > Web Server**.
2. In the **Logout Time** section, select a value from the drop-down list of **Auto Logout Time (min)**.

 **Tip:** You can also enter a custom value in the text field directly. The valid value is from 5 to 120 minutes.

3. Click **Save**.

Service Ports

Manage Service Ports of the PBX

This topic describes the services and the relevant service ports used on the Yeastar P-Series PBX System and how to manage the ports centrally.

Background information

The following table describes the PBX's services and the default ports.

Service	Description	Default Port
HTTPS	HTTPS port for web service.	8088
HTTP	HTTP port for web service.	80
SSH	SSH port is used to access the PBX underlying configurations to debug the system.	8022
SIP UDP	SIP registration port for UDP protocol.	5060
SIP TCP	SIP registration port for TCP protocol.	5060
SIP TLS	SIP registration port for TLS protocol.	5061
Outbound SIP Port	A random port in the port range will be used when sending packets to a SIP server.	5062-5082

Service	Description	Default Port
RTP	RTP ports for transmitting voice audio stream.	10000-12000
Linkus	Port for logging in to Linkus clients.	8111

Procedure

The settings of different services are in different web page, however, you can check or edit the ports centrally on the PBX.

1. Log in to the PBX web interface, go to **System > Network > Service Ports**.

All the service ports are displayed on the web page.

2. To configure a port, click .

You will be redirected to the configuration page of the service.

- a. Enter a new value of the service port.
- b. Click **Save** and **Apply**.

Public IP and Ports

Public IP and Ports Overview

This topic describes the functions of Public IP and Ports settings on Yeastar P-Series PBX System, and introduces different configuration methods.

Functions

Public IP and Ports settings are configured for remote access of Linkus clients and other devices based on SIP protocol. Remote devices can access and communicate with the PBX normally as the Public IP and Ports configurations provide the following two solutions:

- [Solve SIP NAT issue](#)
- [Provide PBX with information of Linkus remote access](#)

Solve SIP NAT issue

If your PBX is connected behind a router, it can be said that the PBX is behind a firewall or Network Address Translation (NAT). To allow remote devices to access the PBX, you need to set up NAT rules and port forwarding on the router. In this way, the router will forward the right inbound packets from the internet to the PBX.

SIP-based communication does not reach devices in the Local Area Network (LAN) behind firewalls and NAT routers automatically. Public IP and Ports settings on the Yeastar P-

Series PBX System provide a SIP NAT solution to ensure that SIP data can be transmitted correctly between the PBX and the public internet.

 **Note:** Yeastar P-Series PBX System doesn't support NAT feature, you need to set up NAT rules and port forwarding on your router.

NAT process

When a request is sent to the public internet, that request will have a source address consistent with the local LAN address (for example, 192.168.6.124).

That local IP address will not be publicly routable because it is a private IP address. NAT replaces the local source IP address with a public IP address which is routable on the public internet.

SIP NAT

NAT only replaces a local IP address with a public IP address for **IP header** in a data packet, but not for **SIP headers**, which may cause one-way audio issue for SIP calls or SIP registration failure.

To solve the SIP issues, you need to configure Public IP and Ports on the PBX. PBX will replace local IP address with public IP address and replace local SIP port with external SIP port before sending the packets to the public internet.

Provide PBX with information of Linkus remote access

The Public IP and Ports configurations allow Linkus remote access by solving SIP NAT issue. In addition, Yeastar P-Series PBX System can generate QR codes and links for Linkus remote access based on the information provided on the **Public IP and Ports** page.

Configuration methods

Yeastar P-Series PBX System supports you to manually configure Public IP and Ports according to your network environment, and also provides Remote Access Service to minimize the configurations and improve network security.

The following NAT types are provided to set up network for remote access:

- [Yeastar FQDN](#)
- [Public IP Address](#)
- [External Host](#)

Yeastar FQDN

Yeastar Fully Qualified Domain Name (FQDN) is a subscription-based service designed to set your team up for anywhere-anytime productivity instantly and securely. Yeastar FQDN frees you from complicated network settings and helps you quickly establish a secure tunnel for remote access.

 **Note:** Yeastar FQDN is only for Linkus remote access and web remote access.

For more information about Yeastar FQDN configurations, see [Configure Network for Remote Access by a Yeastar FQDN](#).

Public IP Address

If your Internet Service Provider (ISP) provides a static public IP address, you can configure PBX network for remote access with the IP address.

For more information about the configurations, see [Configure Network for Remote Access by a Domain Name](#).

External Host

If static public IP address is not available in your network environment, you must have a registered domain name, and configure PBX network for remote access with the domain name.

For more information about the configurations, see [Configure Network for Remote Access by a Public IP Address](#).

Configure Network for Remote Access by a Yeastar FQDN

A Yeastar-supplied Fully Qualified Domain Name (FQDN) frees you from complicated network settings and helps you quickly establish a secure tunnel for remote access. You can create a Yeastar FQDN in the PBX to allow remote access within seconds.

Background information

A Fully Qualified Domain Name (FQDN) is the complete domain name for a specific device on the internet. An FQDN consists of two parts: the hostname and the domain name.

Yeastar-supplied FQDN function has the following advantages and limitations.

Advantages

- For the network environment that has no static public IP address, a Yeastar-supplied FQDN implements a dynamic DNS service for you.
- Simplify network configurations for remote access as the complicated Network Address Translation (NAT) configurations and port forwarding are eliminated.
- Secure remote connections with SSL certificates.

Limitations

Yeastar FQDN is only for Linkus remote access and web remote access.

Prerequisites

You have subscribed Yeastar P-Series Enterprise Plan or Ultimate Plan.

Procedure

1. Log in to the PBX web interface, go to **System > Network > Public IP and Ports**.
2. Turn on **Public IP (NAT)**.
3. In the drop-down list of **NAT Type**, select **Yeastar FQDN**.
4. In the **Fully Qualified Domain Name (FQDN)** field, select a domain name then enter a hostname.

For example, select domain name *ras.yeastar.com* and enter hostname *yeastar*, you will get an FQDN *yeastar.ras.yeastar.com*

 **Note:** Think twice before you enter the hostname. The FQDN cannot be changed after you save the configurations.

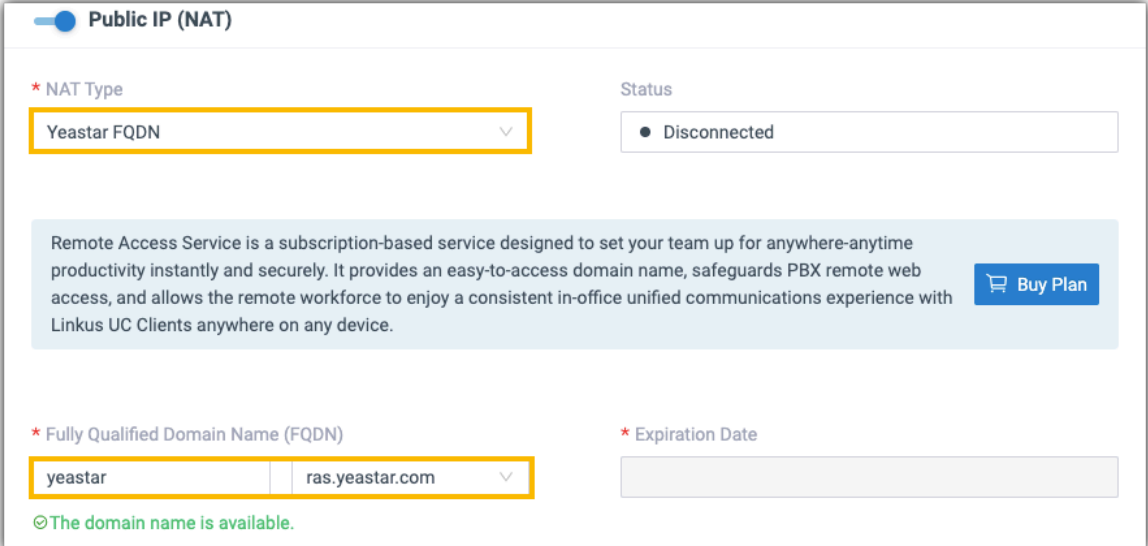

Public IP (NAT)

* NAT Type: Yeastar FQDN

Status: Disconnected

Remote Access Service is a subscription-based service designed to set your team up for anywhere-anytime productivity instantly and securely. It provides an easy-to-access domain name, safeguards PBX remote web access, and allows the remote workforce to enjoy a consistent in-office unified communications experience with Linkus UC Clients anywhere on any device. [Buy Plan](#)

* Fully Qualified Domain Name (FQDN): yeastar | ras.yeastar.com

* Expiration Date: [Empty field]

The domain name is available.

5. Click **Save**.

Result

- Linkus server is automatically set up for remote access, users can use Linkus (Mobile Client, Desktop Client, and Web Client) anywhere anytime.

 **Note:** For Linkus Mobile Client and Desktop Client, the App version should be updated:

- # Linkus Android version: 3.6.9 or later
- # Linkus iOS version: 3.6.8 or later
- # Linkus Windows version: 2.4.8 or later
- # Linkus MacOS version: 2.4.8 or later

- Network for remote web access is automatically configured, users can log in to the PBX web management portal remotely via the FQDN.

What to do next

If your subscription trial period is up or the subscription is not renewed on time, your FQDN will be suspended. To ensure that your FQDN won't be taken by others, you need to subscribe or renew Yeastar P-Series Enterprise Plan or Ultimate Plan in 60 days.

Configure Network for Remote Access by a Domain Name

To ensure that remote Linkus clients and other SIP devices can communicate with Yeastar P-Series PBX System normally, you need to configure Public IP and Ports on the PBX. This topic provides a configuration example based on the network scenario that no static public IP address is available and a domain name is set up for remote connection.

Background information

This topic assumes that your network environment is as follows:

- **Domain name:** pbx.example.com
- **Local network:**
 - # 192.168.6.0/24
 - # 192.168.5.0/24

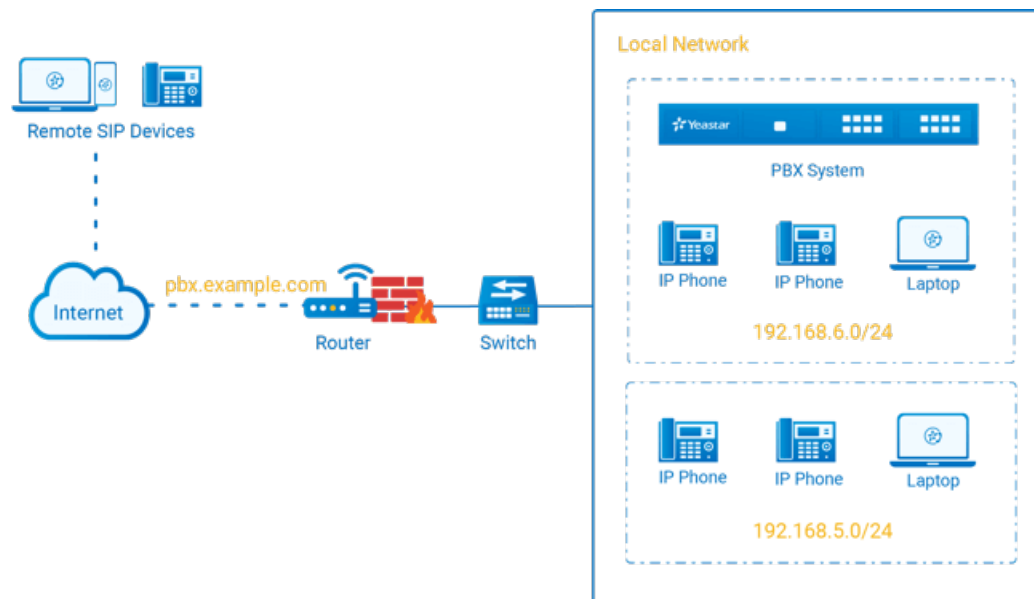

Prerequisites

- You have purchased Dynamic DNS, and bound the domain name with your router.
- If SIP ALG option is provided in your router, disable it.

- You have configured NAT settings and forwarded the following ports to allow remote access of Linkus clients and other SIP devices. To check the relevant internal ports of your PBX, see [Manage Service Ports of the PBX](#).

In this scenario, forward the following ports:

Service	Internal Port	External Port
SIP registration	UDP 5060	UDP 8092
RTP	UDP 10000-12000	UDP 10000-12000
Linkus server	TCP&UDP 8111	TCP&UDP 6090
Linkus web client	TCP 8088	TCP 9099

Procedure

Based on the scenario, configure the Public IP and Ports on PBX as follows.

1. Log in to the PBX web interface, go to **System > Network > Public IP and Ports**.
2. In **Public IP (NAT)** section, complete the following configurations:
 - **Public IP (NAT)**: Turn on this option.
 - **NAT Type**: Select **External Host**.
 - **External Host**: Enter *pbx.example.com*.
 - **Refresh Interval (s)**: Leave the default setting or change the interval (in seconds) for PBX to request the external host for public IP.
 - **Local Network Identification**: Add all your local network. This setting will allow all your local devices to communicate with the PBX by the local IP address instead of passing through the router.

In this scenario, add two local network: 192.168.5.0/255.255.255.0 and 192.168.6.0/255.255.255.0.

- **NAT Mode**: Select a SIP NAT mode. In this scenario, select **Yes**.
 - # **Yes**: Use NAT and ignore the address information in the SIP/SDP headers and reply to the sender's IP address and port.
 - # **No**: Use NAT mode only according to RFC3581.
 - # **Never**: Never attempt NAT mode or RFC3581 support.
 - # **Route**: Use NAT but do not include rport in headers.

Public IP (NAT)

* NAT Type
External Host

* External Host
pbx.example.com

* Refresh Interval (s)
120

Local Network Identification

Network Number	Subnet Mask	Operations
192.168.5.0	255.255.255.0	⊗
192.168.6.0	255.255.255.0	⊗

+ Add IP

* NAT Mode
Yes

3. In the **Public Ports** section, enter the external ports that you have forwarded on your router.
- **External SIP UDP Port:** Enter *8092*.
 - **External SIP TCP Port:** Leave it blank because SIP TCP protocol is not used in this scenario.
 - **External SIP TLS Port:** Leave it blank because SIP TLS protocol is not used in this scenario.
 - **External Linkus Port:** Enter *6090*.
 - **External Web Server Port:** Enter *9099*.

Public Ports

External SIP UDP Port
8092

External SIP TCP Port

External SIP TLS Port

External Linkus Port
6090

External Web Server Port
9099

4. Click **Save**.

Result

- Users can remotely access the PBX web interface and log in to Linkus clients via the domain name.
- Remote devices based on SIP protocol can register to the PBX via the domain name.
- PBX will generate login links and QR codes for Linkus remote access based on the information provided on the **Public IP and Ports** page.

Related information

- [Configure Network for Remote Access by a Yeastar FQDN](#)
- [Configure Network for Remote Access by a Public IP Address](#)
- [Set up a Remote SIP Phone](#)

Configure Network for Remote Access by a Public IP Address

To ensure that remote Linkus clients and other SIP devices can communicate with Yeastar P-Series PBX System normally, you need to configure Public IP and Ports on the PBX. This topic provides a configuration example based on the network scenario that a static public IP address is supplied by the Internet Service Provider (ISP).

Background information

This topic assumes that your network environment is as follows:

- **Public IP address:** 220.169.10.2
- **Local network:**
 - # 192.168.6.0/24
 - # 192.168.5.0/24

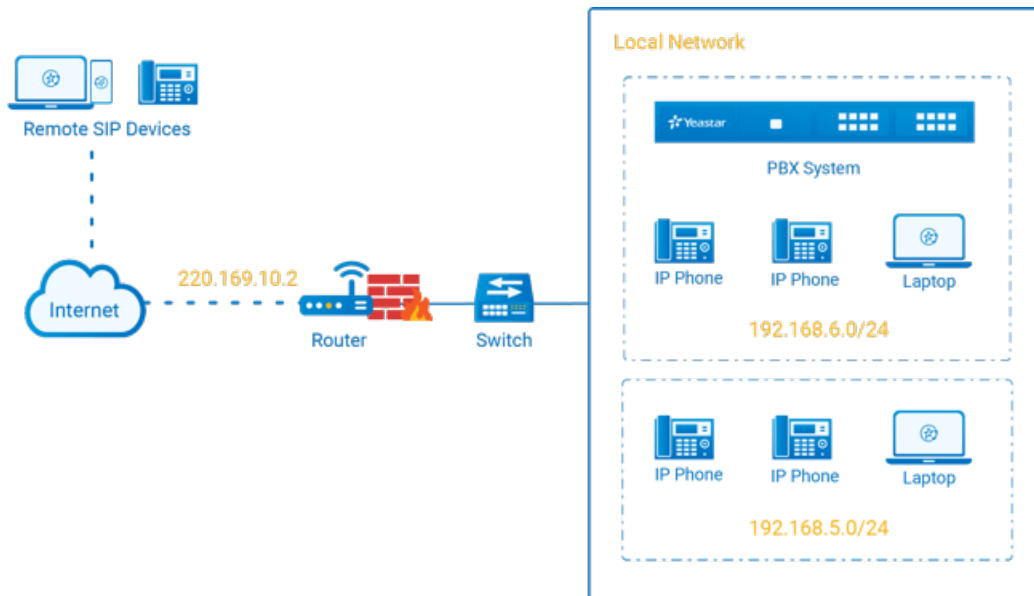

Prerequisites

- If SIP ALG option is provided in your router, disable it.
- You have configured NAT settings and forwarded the following ports to allow remote access of Linkus clients and other SIP devices. To check the relevant internal ports of your PBX, see [Manage Service Ports of the PBX](#).

In this scenario, forward the following ports:

Service	Internal Port	External Port
SIP registration	UDP 5060	UDP 8092
RTP	UDP 10000-12000	UDP 10000-12000
Linkus server	TCP&UDP 8111	TCP&UDP 6090
Linkus web client	TCP 8088	TCP 9099

Procedure

Based on the scenario, configure the Public IP and Ports on PBX as follows.

1. Log in to the PBX web interface, go to **System > Network > Public IP and Ports**.
2. In **Public IP (NAT)** section, complete the following configurations:
 - **Public IP (NAT)**: Turn on this option.
 - **NAT Type**: Select **Public IP Address**.
 - **Public IP Address**: Enter *220.169.10.2*.
 - **Local Network Identification**: Add all your local network. This setting will allow all your local devices to communicate with the PBX by the local IP address instead of passing through the router.

In this scenario, add two local network: 192.168.5.0/255.255.255.0 and 192.168.6.0/255.255.255.0.

- **NAT Mode**: Select a SIP NAT mode. In this scenario, select **Yes**.
 - # **Yes**: Use NAT and ignore the address information in the SIP/SDP headers and reply to the sender's IP address and port.
 - # **No**: Use NAT mode only according to RFC3581.
 - # **Never**: Never attempt NAT mode or RFC3581 support.
 - # **Route**: Use NAT but do not include rport in headers.

The screenshot displays the 'Public IP (NAT)' configuration page. A yellow box highlights the 'NAT Type' dropdown menu set to 'Public IP Address' and the 'Public IP Address' text input field containing '220.169.10.2'. Below this, the 'Local Network Identification' section contains a table with two entries:

Network Number	Subnet Mask	Operations
192.168.5.0	255.255.255.0	⊗
192.168.6.0	255.255.255.0	⊗

At the bottom of the table, there is a '+ Add IP' button. Below the table, the 'NAT Mode' dropdown menu is set to 'Yes'.

- In the **Public Ports** section, enter the external ports that you have forwarded on your router.
 - **External SIP UDP Port:** Enter *8092*.
 - **External SIP TCP Port:** Leave it blank because SIP TCP protocol is not used in this scenario.
 - **External SIP TLS Port:** Leave it blank because SIP TLS protocol is not used in this scenario.
 - **External Linkus Port:** Enter *6090*.
 - **External Web Server Port:** Enter *9099*.

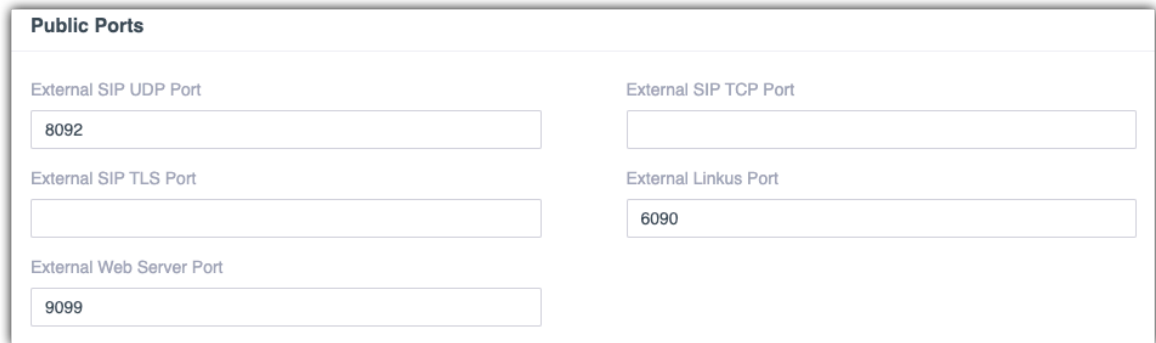

Public Ports	
External SIP UDP Port	External SIP TCP Port
<input type="text" value="8092"/>	<input type="text"/>
External SIP TLS Port	External Linkus Port
<input type="text"/>	<input type="text" value="6090"/>
External Web Server Port	
<input type="text" value="9099"/>	

- Click **Save**.

Result

- Users can remotely access the PBX web interface and log in to Linkus clients via the public IP address.
- Remote devices based on SIP protocol can register to the PBX via the public IP address.
- PBX will generate login links and QR codes for Linkus remote access based on the information provided on the Public IP and Ports page.

Related information

[Configure Network for Remote Access by a Domain Name](#)

[Configure Network for Remote Access by a Yeastar FQDN](#)

[Set up a Remote SIP Phone](#)

Static Route

Static Route Overview

This topic provides an overview of static route table and all associated system routes.

Route table

Yeastar P-Series PBX System provides a route table that contains default system route entries and custom route entries.

default system entries

After you configure the system network, the system automatically adds system routes to the route table for traffic management. You cannot delete the system routes.

For more information, see [System route entries](#).

custom route entries

If the system is in Dual network mode, you need to add a static route to override the default system routes, routing the packets from specific IP address to the specified destination. For more information, see [Add a Static Route](#).

System route entries

System route entries are automatically added after you configure the PBX network. The following route entries are considered as system route entries:

- A **default** route entry. The packets that are destined to any unknown destinations will be routed to the default gateway.
- A route entry destined for the IP address range of LAN or WAN interface. The packets that are destined to the IP address range can be sent directly to the destination.

Example:

The following example describes the automatically added system routes.

Network settings

Both LAN interface and WAN interface are enabled, and LAN is the default interface. The detailed network information is as the followings.

	LAN (Default Interface)	WAN
IP address	192.168.6.124	10.10.1.18
Subnet mask	255.255.255.0	255.255.255.0
Gateway	192.168.6.1	10.10.1.1
Preferred DNS Server	192.168.1.1	10.10.1.1

System route entries

The following route entries are automatically added to the routing table of the PBX.

Destination	Subnet Mask	Gateway	Metric	Interface	Operations
default	0.0.0.0	192.168.6.1	0	LAN	
10.10.1.0	255.255.255.0	0.0.0.0	0	WAN	
192.168.6.0	255.255.255.0	0.0.0.0	0	LAN	

- The route entry with the **Destination** of `default` is the default route entry. By default, all the packets will be routed to the gateway `192.168.6.1` through LAN interface.
- The route entry with the **Destination** of `10.10.1.0/255.255.255.0` is the route entry that is automatically added for WAN interface.

The packets for the network `10.10.1.0/255.255.255.0` don't need to be routed. The network is locally connected, so packets can be sent directly to the destination.

- The route entry with the **Destination** of `192.168.6.0/255.255.255.0` is the route entry that is automatically added for LAN interface.

The packets for the network `192.168.6.0/255.255.255.0` don't need to be routed. The network is locally connected, so packets can be sent directly to the destination.

Add a Static Route

This topic gives a configuration example to show you how to add a static route on Yeastar P-Series PBX System.

Background information

Adding custom static route is typically used in the "Dedicated SIP trunking" scenario.

This topic assume that you have bought a dedicated SIP trunk from the Internet telephony service provider (ITSP) . The ITSP provides a router for the dedicated SIP trunk. The router is used for the SIP trunk only, but cannot access the Internet.

Network topology

The following figure shows the network topology for the dedicated SIP trunking on the PBX.

- All network traffic goes through the default interface LAN.
- The network traffic of SIP trunking `191.8.88.15` will go through the WAN port.

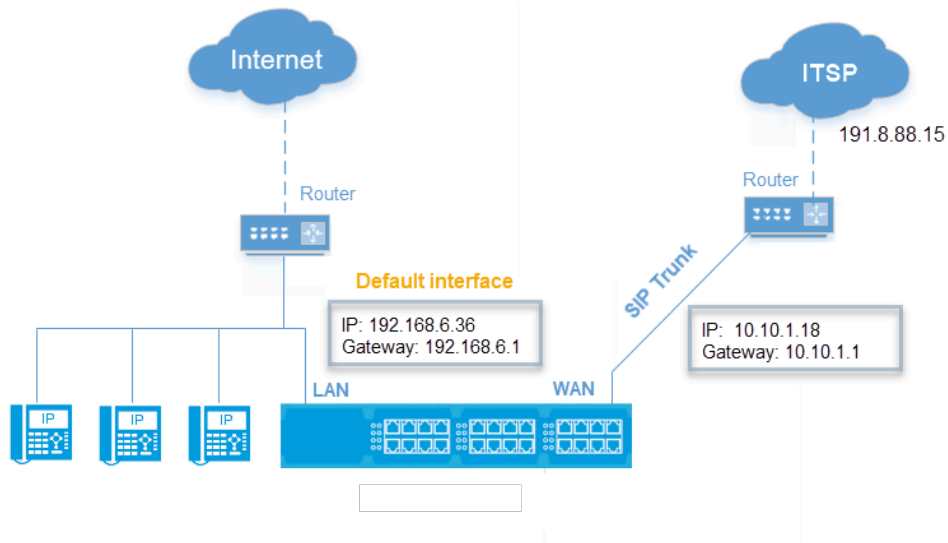

PBX Network settings

Setting	Value
Ethernet Mode	Dual
Default Interface	LAN
LAN	
IP Address	192.168.6.36
Subnet Mask	255.255.255.0
Gateway	192.168.6.1
Preferred DNS Server	192.168.1.1
WAN	
IP Address	10.10.1.18
Subnet Mask	255.255.255.0
Gateway	10.10.1.1
Preferred DNS Server	10.10.1.1

Procedure

To route the network traffic of SIP trunking 191.8.88.15 through WAN port, you need to add a static route on the PBX. Follow the instructions below to add a static route for SIP trunking.

1. Log in to the PBX web interface, go to **System > Network > Static Routes**, click **Add**.
2. On the pop-up window, configure the route entry:

The screenshot shows a dialog box titled "Add Static Route" with a close button (X) in the top right corner. The dialog contains the following fields and values:

- * Destination:** 191.8.88.0
- * Subnet Mask:** 255.255.255.0
- Gateway:** 10.10.1.1
- Metric:** (empty field)
- * Interface:** WAN (selected from a dropdown menu)

At the bottom right of the dialog, there are two buttons: "Cancel" (with an X icon) and "Save" (with a floppy disk icon).

- **Destination:** Enter the destination IP address or IP subnet for the PBX to reach using the static route.

 **Note:** To ensure that both SIP registration packets and SIP media packets can be routed to the desired destination, set the IP range of the SIP trunking. In this scenario, enter *191.8.88.0*.

- **Subnet Mask:** Enter the subnet mask for the destination address. In this scenario, enter *255.255.255.0*.
- **Gateway:** Enter the gateway address. The PBX will reach the destination address through this gateway. In this scenario, enter *10.10.1.1*.
- **Metric:** Optional.

Routing metric is used to determine whether one route should be chosen over another.

- **Interface:** Select the network interface.

The PBX will reach the destination address using the static route through the selected network interface. In the scenario, select **WAN**.

3. Click **Save** and **Apply**.

Result

After you set up a SIP trunk with the IP address 191.8.88.15 on the PBX, the SIP packets are sent and received by the WAN port, which ensure the communication between the PBX and the ITSP.

What to do next

To avoid SIP audio issues through the SIP trunk, you may need to add the network segment of the SIP trunk as a local network identification in PBX NAT settings.

In this scenario, add the IP segment 191.8.88.0/255.255.255.0 in the NAT settings as the following figure shows. For more information of NAT, see [Configure Network for Remote Access by a Domain Name](#).

Local Network Identification		
network number	Subnet Mask	Operations
192.168.6.0	255.255.255.0	⊗
191.8.88.0	255.255.255.0	⊗

Manage Static Routes

After you add static routes on the Yeastar P-Series PBX System, you can edit or delete them.

Edit a static route

1. Log in to the PBX web interface, go to **System > Network > Static Routes**.
2. Click  beside the static route that you want to edit.
3. Edit the static route settings.
4. Click **Save**.

Delete a static route

1. Log in to the PBX web interface, go to **System > Network > Static Routes**.
2. Click  beside the static route that you want to delete.
3. Click **Yes** to confirm the deletion.

Date and Time

Change System Time Manually

In case you want to change system time when the PBX can not access the Internet, you can change system time manually. This topic describes how to manually change system time to your local time.

Background information

To ensure that the time of logs and CDRs generated on Yeastar P-Series PBX System is consistent with your local time, you need to adjust system time to your local time.

Procedure

1. Log in to the PBX web interface, go to **System > Date and Time**.
2. In the **Date and Time** section, set your local date and time.
 - a. In the **Time Zone** drop-down list, select your current time zone.
 - b. **Optional:** Configure **Daylight Saving Time** according to your needs.
 - c. Choose **Set Up Manually** and set the date and time.
3. In the **Display Format** section, set the display format of date and time.
 - **Date Display Format**
 - # Year/Month/Day
 - # Month/Day/Year
 - # Day/Month/Year
 - **Time Display Format**
 - # 12-hour format
 - # 24-hour format
4. Click **Save** and **Apply**.
5. Reboot the PBX to take effect.

Result

The current system time is updated; the time of logs and CDRs are also updated.

Synchronize System Time with an NTP Server

If the PBX can access the Internet, you can use an NTP server to synchronize system time. This topic describes how to synchronize system time with an NTP server.

Background information

To ensure that the time of logs and CDRs generated on Yeastar P-Series PBX System is consistent with your local time, you need to adjust system time to your local time.

Prerequisites

Make sure Yeastar P-Series PBX System can access the Internet.

Procedure

1. Log in to the PBX web interface, go to **System > Date and Time**.
2. In the **Date and Time** section, configure the following settings:
 - a. In the **Time Zone** drop-down list, select your current time zone.
 - b. **Optional:** Configure **Daylight Saving Time** according to your needs.
 - c. Choose **Synchronize with NTP Server**.
 - d. Retain the default value of **NTP Server** or enter the URL of t an NTP server.
3. In the **Display Format** section, set the display format of date and time.
 - **Date Display Format**
 - # Year/Month/Day
 - # Month/Day/Year
 - # Day/Month/Year
 - **Time Display Format**
 - # 12-hour format
 - # 24-hour format
4. Click **Save** and **Apply**.
5. Reboot the PBX to take effect.

Result

The current system time is updated; the time of logs and CDRs are also updated.

Email Server

Email Server Overview

This topic describes SMTP server, email template, email daily sending limit, and email sent logs.

Email server

Emails to users or the administrator are required in the following situations:

- Send Linkus welcome email.
- Send fax to email.
- Send voicemail to email.

- Send event notifications.

You can use the built-in Yeastar SMTP server or custom SMTP server to send emails.

For the built-in SMTP server, see [Set up Yeastar SMTP Server as an Email Server](#).

For the custom SMTP server, see [Set up Gmail as an Email Server](#) and [Set up Outlook as an Email Server](#).

Email template

Yeastar P-Series PBX System has default email templates for different events, you can also customize email templates according to your needs.

For more information, see [Customize Email Templates](#).

Email daily sending limit

If you use custom email server to send emails, you need to know that email server may limit the number of emails that users can send per day to keep system healthy and account safe.

Yeastar P-Series PBX System obtains the quantity from the email server. If reaching the sending limit, users can NOT send emails via the email server.

Email sent logs

Yeastar P-Series PBX System provides email sent logs, which allows you to monitor mail delivery, and offers you error messages to help you troubleshoot delivery issues more quickly.

For more information, see [Email Sent Logs](#).

Set up Yeastar SMTP Server as an Email Server

This topic describes how to set up Yeastar SMTP server as the email server of Yeastar P-Series PBX System.

Prerequisites

Make sure Yeastar P-Series PBX System can access the Internet.

Procedure

1. Log in to the PBX web interface, go to **System > Email > Email Server**.
2. In the **Type of Email Server** drop-down list, select **Yeastar SMTP Server**.
3. Test if the email server can successfully send emails.
 - a. Click **Test**.
 - b. In the pop-up window, enter a recipient's email address in the **Email Address** field.
 - c. Click **Test**.

Result

- If the test email is sent successfully, the page displays "Success" and the recipient's mailbox would receive the email.
- If the test email is failed to be sent, the page displays "Failed to send" and prompts you an error message. You can check the error in [Email Sent Logs](#).

Set up Gmail as an Email Server

This topic describes how to set up Gmail as an email server in Yeastar P-Series PBX System.

Prerequisites

Make sure Yeastar P-Series PBX System can access Google Server.

Step1. Create an app password on Google Account

To ensure that the PBX can access Gmail server, you need to turn on 2-Step verification and create an app password as follows.

1. Sign in to [Google Account](#) by your Gmail account.
2. On the left navigation bar, click **Security**.
3. Turn on 2-Step Verification.
 - a. In the **Signing in to Google** section, click **2-Step Verification** and enter your Gmail password to verify your account.
 - b. On the **2-Step Verification** page, click **GET STARTED** and enter your Gmail password to verify your account.
 - c. Select a verification method, verify your account according to the prompt.
 - d. Click **TURN ON** to turn on 2-step verification.

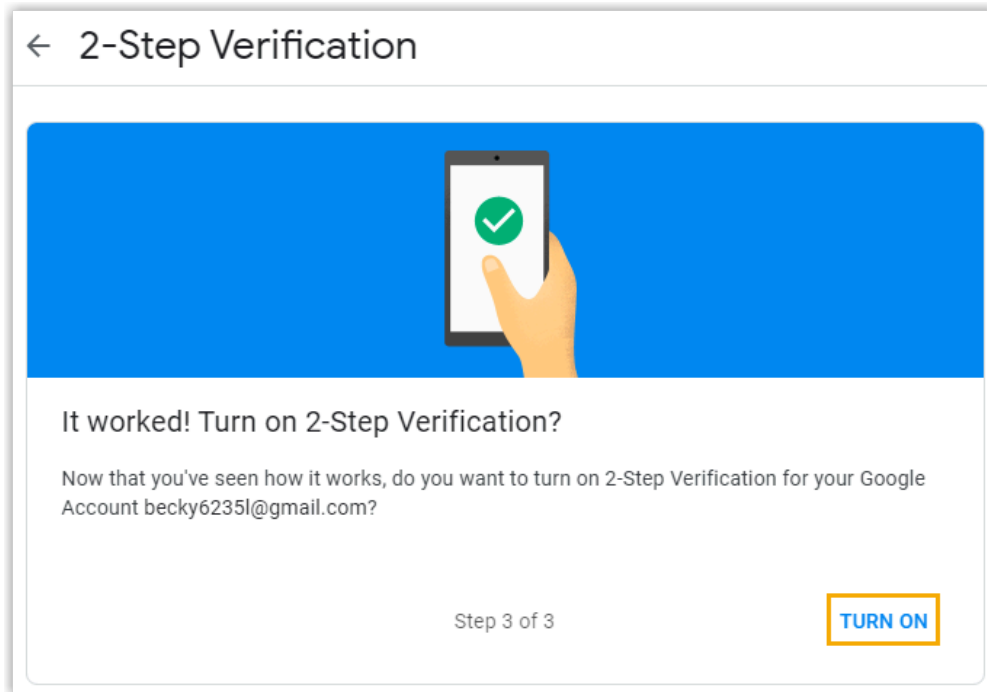

4. Right above the page, click ← to back to the security page.
5. Create an app password.
 - a. In the **Signing in to Google** section, click **App passwords** and enter your Gmail password to verify your account.
 - b. In the **Select app** drop-down list, select **Other (Custom name)**.
 - c. In the text field, enter a name to help you identify the app password. For example, enter *Yeastar PBX*.
 - d. Click **GENERATE**.

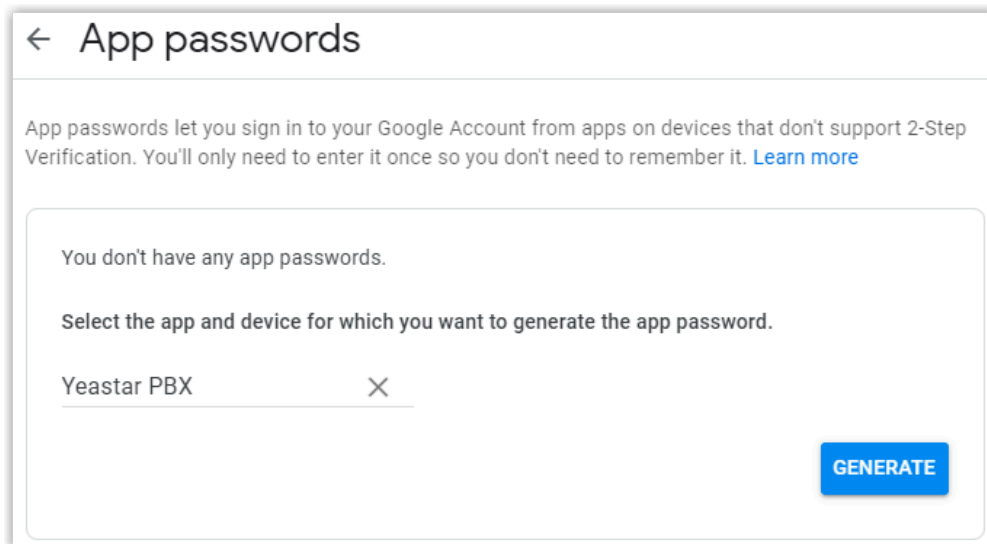

An app password is generated. Note down the password, which is used to verify your Gmail account when you configure Gmail as the mail server in the PBX.

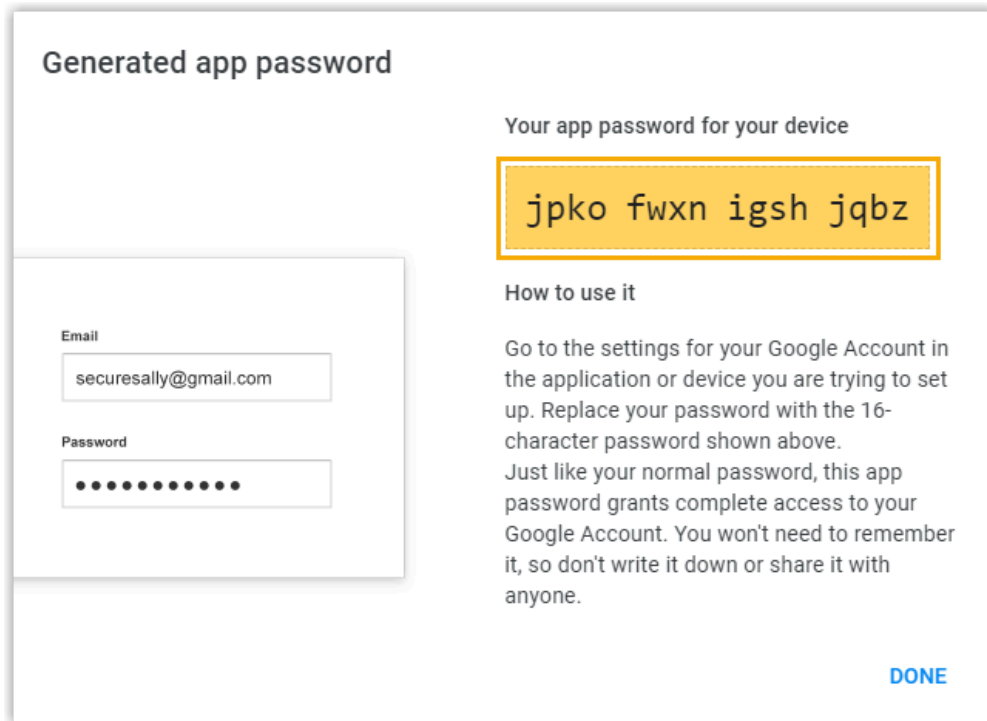

Step2. Configure Gmail as mail server of Yeastar P-Series PBX System

To ensure that the PBX can access Gmail server via your Google account, you need to proceed as follows:

1. Log in to the PBX web interface, go to **System > Email > Email Server**.
2. In the **Type of Email Server** drop-down list, select **Custom Email Server**.
3. Configure email server settings.
 - **Sender Email Address:** Enter your Gmail address, which will appear as the From address for outgoing emails sent by the PBX.
 - **Email Address or Username:** Enter your Gmail address.
 - **Password:** Enter the 16-digit app password, which is used to access Gmail server.
 - **Outgoing Mail Server (SMTP):** Retain the default value *smtp.gmail.com*.
 - **Port:** Retain the default value *587*.
 - **Enable TLS Encryption:** Keep the option unselected.
4. Test if the mail server can successfully send emails.
 - a. Click **Test**.
 - b. In the pop-up window, enter a recipient's email address in the **Email Address** field.
 - c. Click **Test**.
5. Click **Save**.

Result

- If the test email is sent successfully, the page displays "Success" and the recipient's mailbox would receive the email.
- If the test email is failed to be sent, the page displays "Failed to send" and prompts you an error message. You can check the error in [Email Sent Logs](#).

Set up Outlook as an Email Server

This topic describes how to set up Outlook as an email server in Yeastar P-Series PBX System.

Prerequisites

Make sure the PBX can access the Internet.

Step1. Create an app password on Microsoft Account

To ensure that PBX can access Outlook server via your Microsoft account, you need to turn on 2-Step verification and create an app password as follows.

1. Sign in to [Microsoft Account](#).
2. At the top navigation bar, click **Security** tab and enter your Outlook password to verify your account.
3. Turn on 2-Step Verification.
 - a. In the **Two-step verification** section, click **Turn on**, and verify your account according to the prompt.

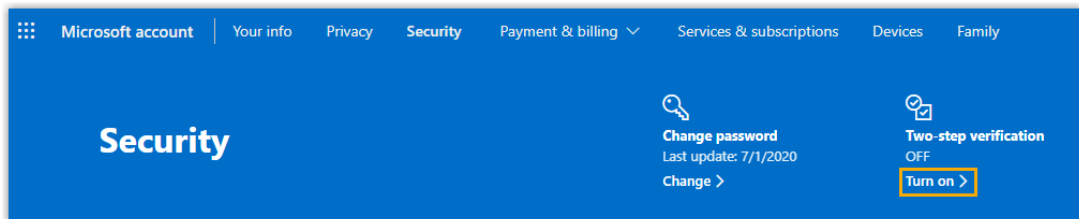

- b. In the **Two-step verification** section, click **Set up two-step verification**.
 - c. Read the tips and click **Next**.
 - d. In the **Verify my identity with** drop-down list, select a method and verify your account according to the prompt.

Two-step verification is enabled.
4. Create an app password.
 - a. At the top navigation bar, click **Security** tab.
 - b. In the **Two-step verification** section, click **Manage**.
 - c. In the **App passwords** section, click **Create a new app password**.

Use this app password to sign in

Enter the app password below in the password field of the app or device that can't accept security codes. If you're not sure how to update your app or device with an app password, [follow these steps](#).

App password

For each app or device that can't accept security codes, you need to create a new app password to use instead.
[Create another app password](#)

An app password is generated. Note down the password, which is used to verify your Outlook account when you configure Outlook as the mail server of the PBX.

Step2. Configure Outlook as email server of Yeastar P-Series PBX System

To ensure that the PBX can access and send mails from Outlook server via your Microsoft account, you should proceed as follows:

1. Log in to the PBX web interface, go to **System > Email > Email Server**.
2. In the **Type of Email Server** drop-down list, select **Custom Email Server**.
3. Configure email server settings.
 - **Sender Email Address:** Enter your Outlook address, which will appear as the From address for outgoing emails sent by the PBX.
 - **Email Address or Username:** Enter your Outlook address.
 - **Password:** Enter the 16-digit app password, which is used to access Outlook server.
 - **Outgoing Mail Server (SMTP):** Retain the default value *smtp-mail.outlook.com*.
 - **Port:** Retain the default value *587*.
 - **Enable TLS Encryption:** Keep the option unselected.
4. Test if the mail server can successfully send emails.
 - a. Click **Test**.
 - b. In the pop-up window, enter a recipient's email address in the **Email Address** field.
 - c. Click **Test**.
5. Click **Save**.

Result

- If the test email is sent successfully, the page displays "Success" and the recipient's mailbox would receive the email.
- If the test email is failed to be sent, the page displays "Failed to send" and prompts you an error message. You can check the error in [Email Sent Logs](#).

Customize Email Templates

This topic describes how to customize email notification language and email templates.

Background information

If you have enabled notification for a specific event, and have chosen to send emails to notify contacts, the system will send emails in the pre-configured email template to inform contacts when the event is triggered.

Yeastar P-Series PBX System provides the following types of email templates:

- **Operation:** Changes of password and login status.
- **Telephony:** SIP trunk registration and emergency calling.
- **System:** System performance, such as CPU overload, memory overload, new system firmware detected, etc.
- **Security:** Such as web login block, auto defense, etc.
- **Event Reminder:** Reminders related with the subscribed plan and services.
- **Email:** Email notifications related with extensions.

Procedure

1. Log in to the PBX web interface, go to **System > Email > Email Templates**.
2. Set the language of notification emails.

 **Note:** If you fail to find the desired language, you can update templates based on **English**.

- a. Click **Notification Email Language**.
- b. In the pop-up window, select a language from the drop-down list.
- c. Click **Save**.

The system will send emails in the selected language.

3. Edit a desired email template.
 - a. In the **Email Templates** list, click  beside the desired email template.
 - b. In the **Template** drop-down list, select **Custom**.
 - c. Edit email subject and content according to your needs.

 **Note:** Images, videos, and audios are not supported.

4. Click **Save** and **Apply**.

Email Sent Logs

This topic introduces email sent logs and describes how to query logs.

Email sent logs overview

Email sent logs allow you to monitor mail delivery and provide you with error messages to help you troubleshoot delivery issues more quickly.

Storage of email sent logs

Email sent logs are saved in local storage, you can NOT change the storage location.

Auto cleanup of email sent logs

By default, when logs reach 50,000, the newest logs will replace the oldest logs. You can change the value, or restrict how long logs can be saved.

For more information, see [Auto Cleanup Settings](#).

Query email sent logs

1. Log in to the PBX web interface, go to **System > Email > Email Sent Logs**.
2. Query logs by the following criteria according to your needs.
 - **Send Result:** Query all logs or query logs by send result.
 - **Email Template Name:** Query logs by email template.
 - **Generated Time:** Query logs by the generated date and time.
 - **Email Recipient:** Query logs by emails' recipients.

After logs are filtered, you can hover your mouse over **Failed** beside the failed log to check the error message.

Generated Time	Email Template Name	Email Recipient	Last Send Time	Send Result	Return Code
08/13/2020 14:46:26	Extension User Password Changed	becky@yeastar.com	08/13/2020 14:46:26	Succeeded	-
08/13/2020 14:45:56	Extension User Password Changed	becky@yeastar.com	08/13/2020 14:45:56	Succeeded	-
08/13/2020 14:04:53	SLA Alarm Threshold Reached		08/13/2020 14:05:09	Failed	-

Storage

Storage Overview

Yeastar P-Series PBX System provides local storage and supports external storage and network drive storage. You can choose where to store voicemails, logs, and recording files.

Storage limitation

Table 34.

Storage	P550	P560	P570
Local	1	1	1
USB 2.0	1	1	1
Hard Disk	0	1	1
SD Card (Up to 256 GB)	0	1	1
Network drive	1	2	2

Which data can be stored

The following data can be stored on local flash of the PBX or external device.

- Voicemail
- Logs, including event logs, email sent logs, operation logs, and system logs.
- Recordings





 **Note:** Recording files can be stored on external device ONLY.





For more information, see [Manage Storage Locations](#).

By default, data will be periodically cleared when it reaches the system limit. For more information, see [Auto Cleanup Settings](#).

Manage storage devices

The **Storage Devices** section shows the local storage, external storage and network drive. You can click specific icons to manage storage devices.

- Click  to refresh the status.
- Click  to edit network drive settings.
- Click  to delete a network drive.
- Click  to format USB, hard disk, or SD card
- Click  to remove USB, hard disk, or SD card.

Storage Devices						
Name	Type	Status	Total	Available	Usage	Operations
LOCAL	Local	Connected	6.14G	4.12G	<div style="width: 33%;"></div> 33%	
HD	Hard Disk	Not Inserted	0.00G	0.00G	<div style="width: 0%;"></div> 0%	
SD	SD Card	Not Inserted	0.00G	0.00G	<div style="width: 0%;"></div> 0%	
USB	USB	Connected	869.30G	665.12G	<div style="width: 23%;"></div> 23%	 
testnet55	Network Drive	Connected	65.49G	42.49G	<div style="width: 36%;"></div> 36%	 

Set up a USB Flash Drive

This topic describes how to set up a USB flash drive on Yeastar P-Series PBX System.

Prerequisites

Prepare a USB 2.0 flash drive.

Procedure

1. Insert the USB flash drive to the PBX's USB port.
2. Format the USB flash drive.

 **Note:** All the data in the USB flash drive will be cleared after formatting. We recommend that you back up data in advance.

- a. Log in to the PBX web interface, go to **System > Storage > Storage Devices**, find the USB flash drive.
 - b. In the **Operations** column, click .
 - c. In the pop-up dialog box, click **OK**.
- The USB flash drive is formatting.
3. In the **Storage Devices** section, check status of the USB flash drive.
 - **Connected:** The USB flash drive is connected.
 - **Not Inserted:** No USB flash drive is inserted.
 - **Error:** Format error.
 - **Read Only:** Can NOT write data to the USB flash drive.

What to do next

Decide what data will be stored on the USB flash drive. For more information, see [Manage Storage Locations](#).

Set up a Hard Disk Drive

This topic describes how to set up a hard disk drive on Yeastar P-Series PBX System.

Prerequisites

- Make sure your PBX supports hard disk drive.

 **Note:** Hard disk drive is only supported on P560 and P570.

- Make sure your PBX is power off.
- Prepare a 2.5" SATA hard disk drive.

Procedure

1. Install hard disk drive on Yeastar P-Series PBX System.
 - a. Loosen the screws at the bottom of the device and remove the upper cover.

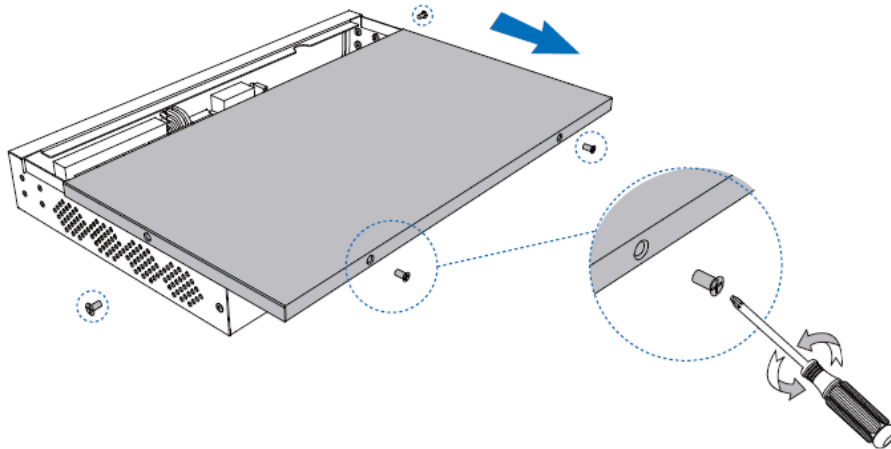

- b. Lock the hard disk drive on the bracket.

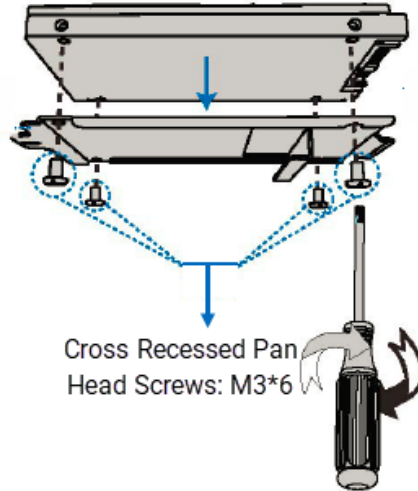

c. Push the hard disk drive to the right.

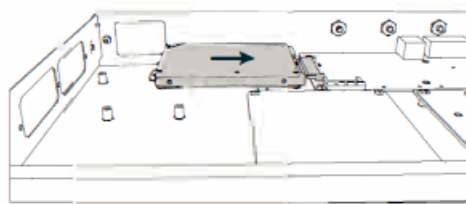

d. Lock the screws to fix the hard disk drive.

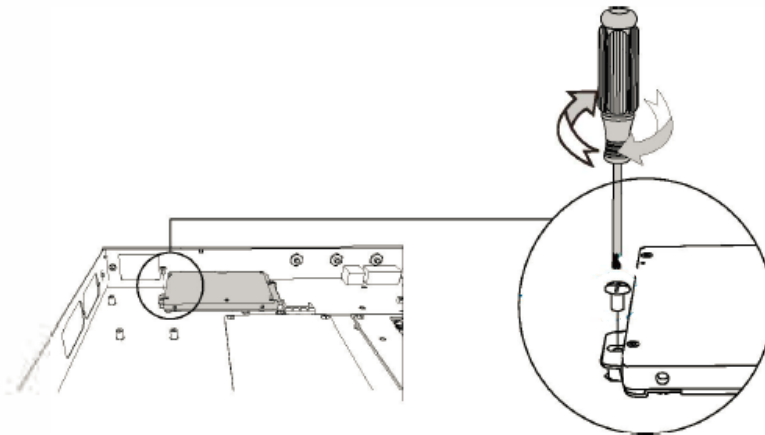

2. Format the hard disk drive.

Note: All the data in the hard disk drive will be cleared after formatting. We recommend that you back up data in advance.

- a. Log in to the PBX web interface, go to **System > Storage > Storage Devices**, find the hard disk drive.
 - b. In the **Operations** column, click .
 - c. In the pop-up dialog box, click **OK**.
- The hard disk drive is formatting.
3. In the **Storage Devices** section, check status of the hard disk drive.
 - **Connected:** The hard disk drive is connected.
 - **Not Inserted:** No hard disk drive is inserted.
 - **Error:** Format error.
 - **Read Only:** Can NOT write data to the hard disk drive.

What to do next

Power on the PBX, and decide what data will be stored on the hard disk drive. For more information, see [Manage Storage Locations](#).

Set up an SD Card

This topic describes how to set up an SD card on Yeastar P-Series PBX System.

Prerequisites

- Make sure your PBX supports SD card.
-  **Note:** SD card is only supported on P560 and P570.
- Prepare an SD card, which meets the following requirements:
 - # Maximum capacity: Up to 256 GB
 - # Minimum performance: SDHC/SDXC Class10 UHS-I U3
 - # Minimum write speed: 60 MB/s
 - # Recommended brands: Sandisk Extreme Pro Series, Sandisk Extreme Series, TOSHIBA EXCERIA Series, or Samsung Pro Series.

Procedure

1. Insert the SD card to the PBX's SD card slot.
2. Format the SD card.

 **Note:** All the data in the SD card will be cleared after formatting. We recommend that you back up data in advance.

- a. Log in to the PBX web interface, go to **System > Storage > Storage Devices**, find the SD card.
- b. In the **Operations** column, click .
- c. In the pop-up dialog box, click **OK**.

The SD card is formatting.

3. In the **Storage Devices** section, check status of the SD card.
 - **Connected:** The SD card is connected.
 - **Not Inserted:** No SD card is inserted.
 - **Error:** Format error.
 - **Read Only:** Can NOT write data to the SD card.

What to do next

Decide what data will be stored on the SD card. For more information, see [Manage Storage Locations](#).

Add a Windows Network Drive

Network drive is used to extend storage space. You can save voicemails, recordings, and logs on a network drive. This topic describes how to add a shared folder on Windows 10 and mount the shared folder to Yeastar P-Series PBX System.

Restriction

There are restrictions for the number of network drives that can be added for each model:

- **Yeastar P550:** Max. 1 network drive
- **Yeastar P560:** Max. 2 network drive
- **Yeastar P570:** Max. 2 network drive

Prerequisites

Make sure that the computer is always in service, or Yeastar P-Series PBX System cannot add files to the shared folder.

Step1. Create a shared folder in Windows 10

1. On your computer, create a folder and specify a name to help you identify it.
2. Right click the folder, select **Properties > Sharing**.
3. Click **Share...**, configure the Share properties.

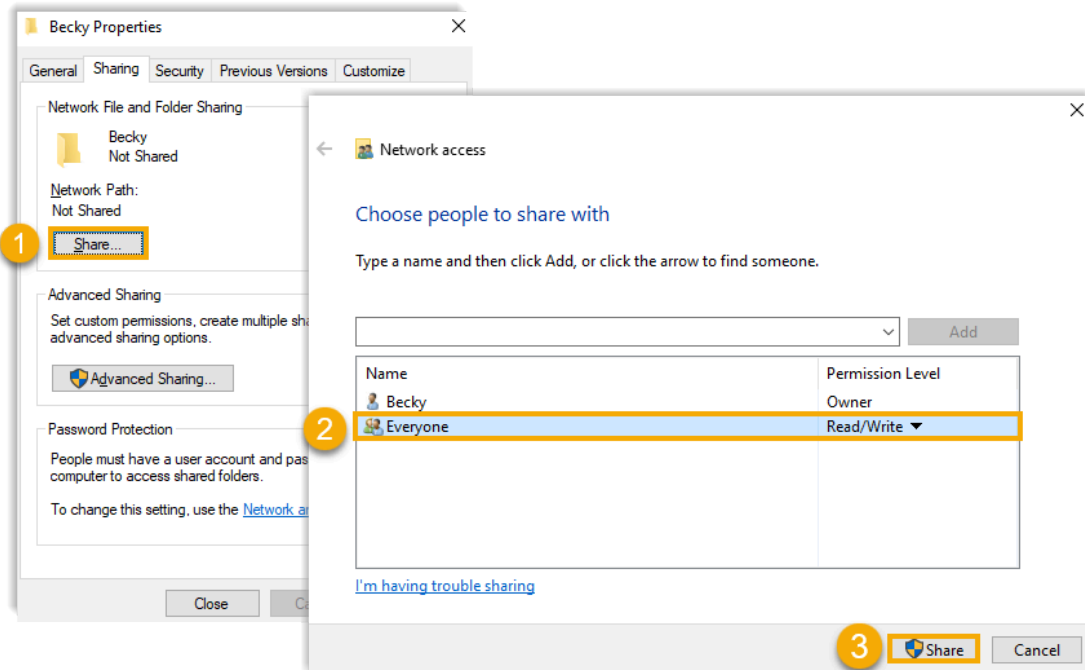

- a. Share the folder to **Everyone**.
 - b. In the **Permission Level** column, select **Read/Write** from the drop-down list.
 - c. Click **Share**.
 - d. In the pop-up dialog box, click **Done**.
4. Click **Advanced Sharing...**, configure advanced Share properties.

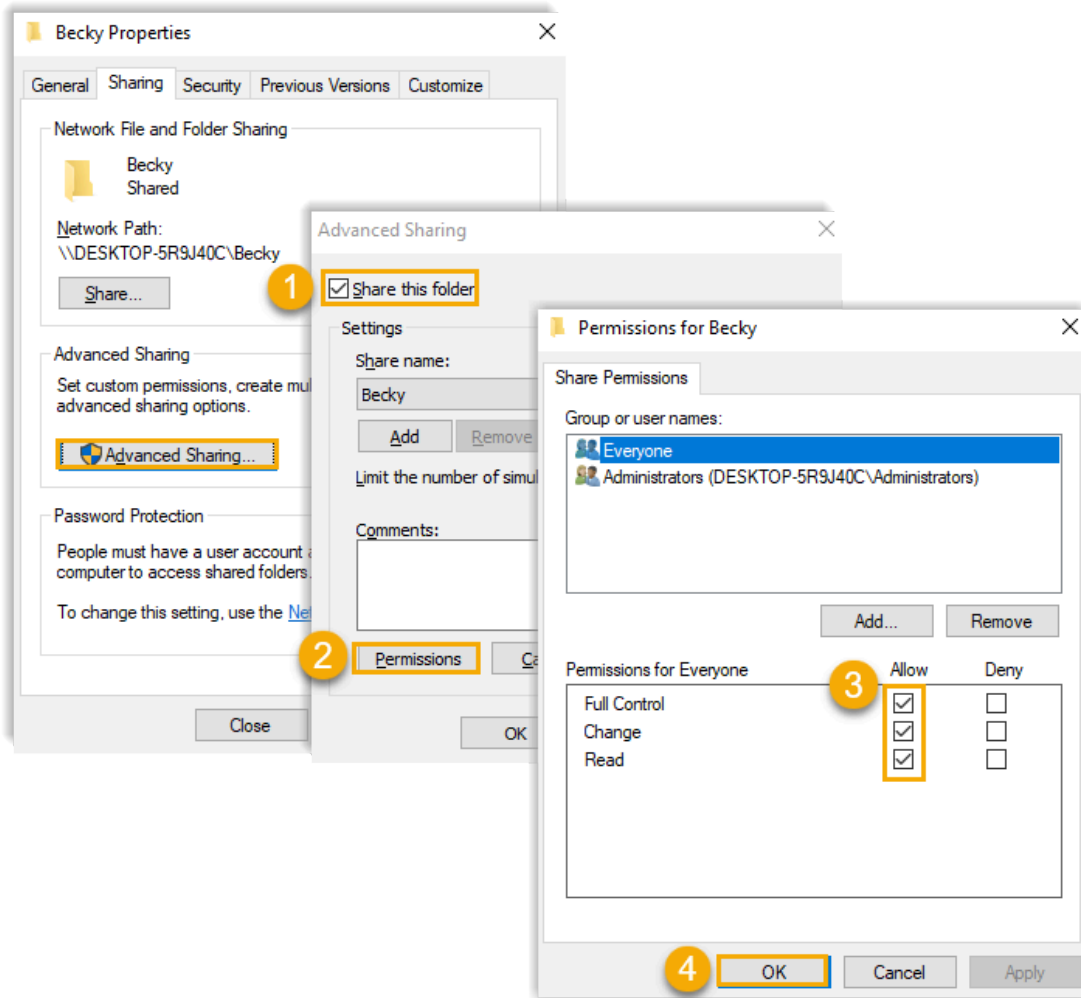

- a. Select the checkbox of **Share this folder**.
- b. Click **Permissions**.
- c. In the pop-up window, allow all the permissions.
- d. Click **OK**.

Step2. Turn off Windows Defender Firewall

1. On your computer, go to **Control Panel > Windows Defender Firewall**.
2. On the left navigation bar, click **Turn Windows Defender Firewall on or off**.

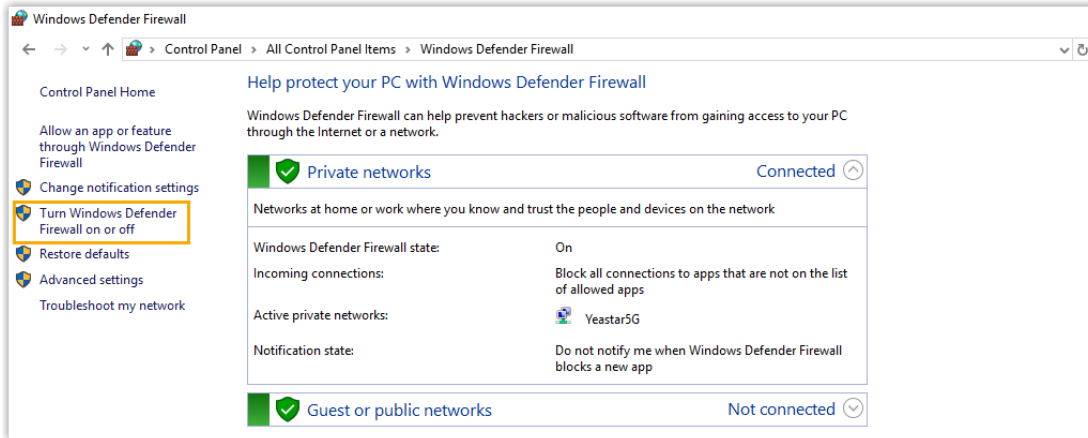

3. In both **Private network settings** and **Public network settings** sections, select **Turn off Windows Defender Firewall (not recommended)**.

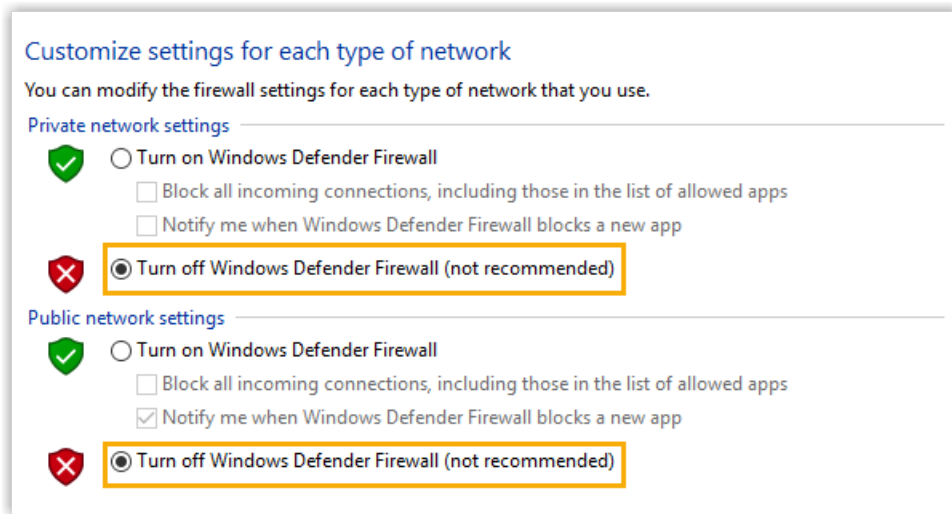

4. Click **OK**.

Step3. Mount the shared folder to PBX

1. Log in to the PBX web interface, go to **System > Storage > Storage Locations**.
2. In the **Storage Devices** section, click **Add Network Drive**.
3. In the pop-up window, configure the following settings.
 - **Name:** Specify a name to help you identify the network drive.
 - **Host/IP:** Enter the IP address of the Windows PC.
 - **Share Name:** Enter the name of the shared folder that you have created on the Windows PC.

 **Note:** To mount a subdirectory of the shared folder, enter `{share_folder_name/subdirectory_name}`.

- **Access Username:** Enter the username to access the shared folder.

[How to check the username that is used to access the shared folder?](#)





- **Access Password:** Enter the password to access the shared folder.
[How to configure Network Drive if no password is set on the Windows PC?](#)
- **Work Group:** Optional. If you have set work group on your network drive, enter the name of the work group. If not, leave this field blank.
- **Samba Version:** Select the Samba version for the network drive. The default value is **Auto**.

4. Click **Save**.

Step4. Check connection status

In the **Storage Devices** section, check status of the network drive.

- **Connected:** The network drive is connected.
- **Unmounted:** No network drive is mounted.
- **Read Only:** Can NOT write data to the network drive.
- **Error**

Storage Devices						
Name	Type	Status	Total	Available	Usage	Operations
LOCAL	Local	Connected	6.14G	4.12G	<div style="width: 33%;"></div> 33%	
HD	Hard Disk	Not Inserted	0.00G	0.00G	<div style="width: 0%;"></div> 0%	
SD	SD Card	Not Inserted	0.00G	0.00G	<div style="width: 0%;"></div> 0%	
USB	USB	Connected	869.30G	665.12G	<div style="width: 23%;"></div> 23%	 
testnet55	Network Drive	Connected	65.49G	42.49G	<div style="width: 36%;"></div> 36%	 

What to do next

Decide what data will be stored on the network drive. For more information, see [Manage Storage Locations](#).

Network Drive FAQ

1. **How to check the user name that is used to access the shared folder?**
 - a. On the Windows PC where the shared folder is created, press  + R key to open the Run Window.

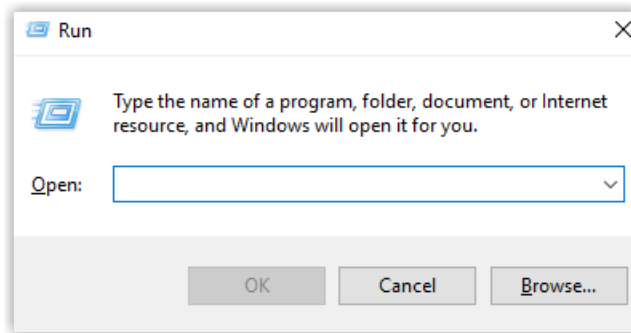

- b. Enter `cmd` and click **OK**.

The user name is displayed on the Command Prompt.

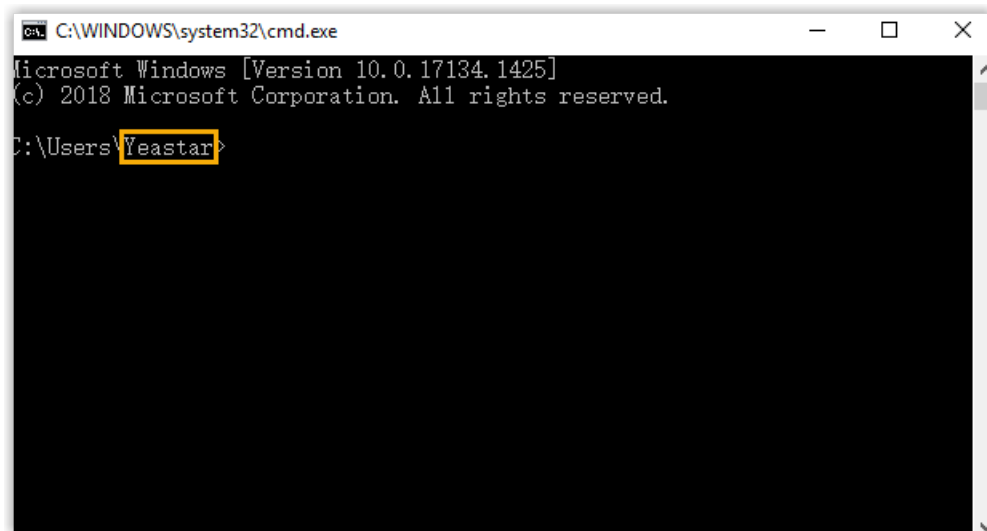

2. How to configure Network Drive if no password is set on the Windows PC?

- We recommend that you set a password on the Windows PC.

Enter the access password on PBX when you configure the Network Drive, then try to mount the network drive again.

- If you want to leave the blank password on the Windows PC, configure the following settings, and try to mount the network drive again.
 - a. On the Windows PC, go to **Control Panel > Network and Internet > Network and Sharing Center > Change advanced sharing settings > All Networks > Password protected sharing**, select **Turn off password protected sharing**.

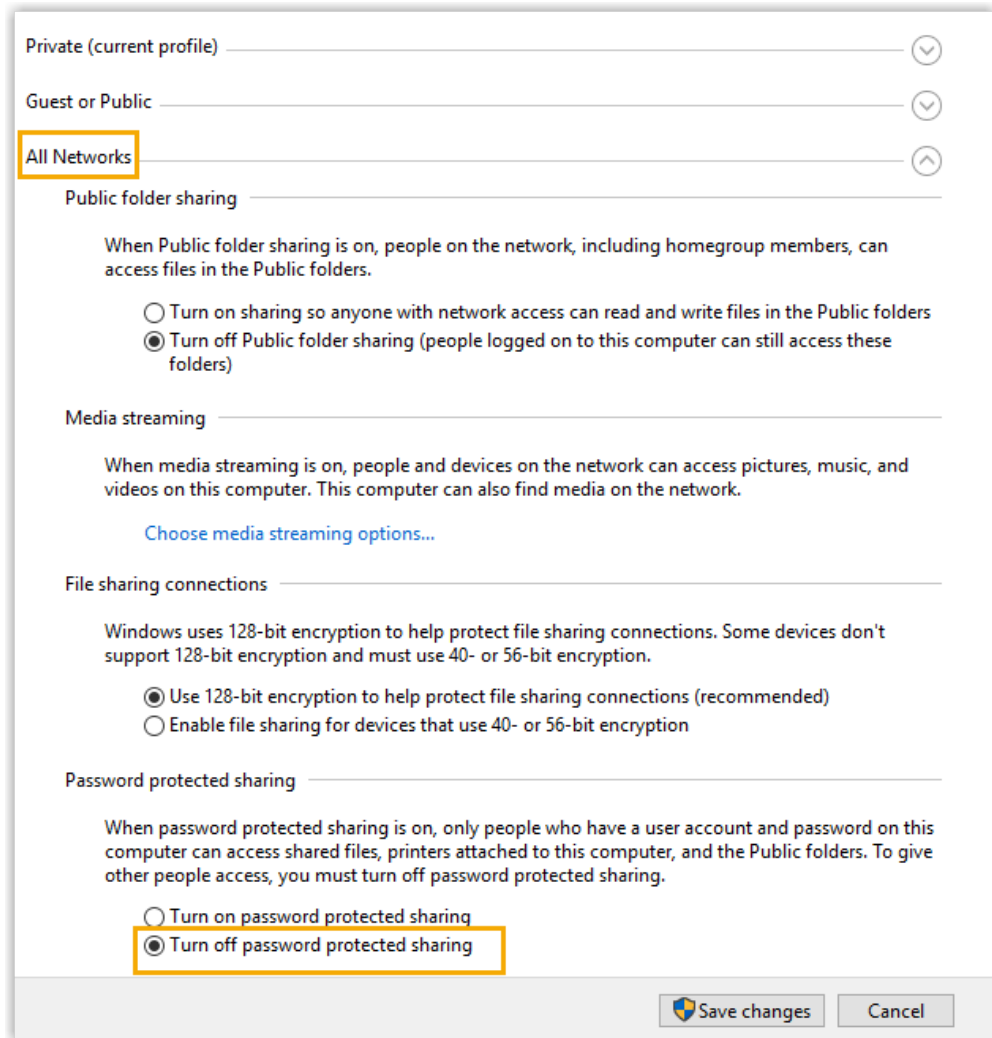

- b. On the Network Drive configuration page, leave the **Username** and **Password** blank.

Add a Mac Network Drive

Network drive is used to extend storage space. You can save voicemails, recordings, and logs on a network drive. This topic describes how to add a shared folder on Mac and mount the shared folder to Yeastar P-Series PBX System.

Restriction

There are restrictions for the number of network drives that can be added for each model:

- **Yeastar P550:** Max. 1 network drive
- **Yeastar P560:** Max. 2 network drive
- **Yeastar P570:** Max. 2 network drive



Prerequisites

Make sure that the computer is always in service, or Yeastar P-Series PBX System cannot add files to the shared folder.

Step1. Create a shared folder on Mac

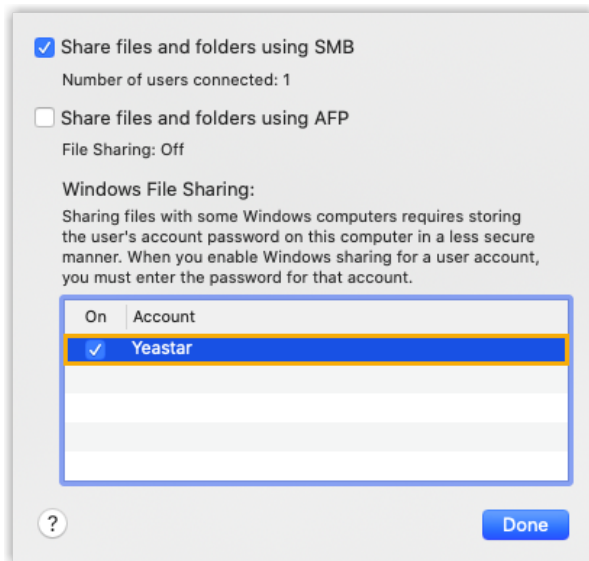
1. On your Mac, create a folder and specify a name to help you identify it.
2. Go to **Apple menu**  > **System Preferences** > **Sharing** to set up file sharing.
 - a. On the left navigation bar, select the checkbox of **File Sharing**.
 - b. Click **Options** to configure sharing credentials.



- i. Select the checkbox of **Share files and folders using SMB**.
- ii. In the **Windows File Sharing** section, enable the admin account and enter login password.
- iii. Click **Done**.
- c. In the **Shared Folders** section, click  to add the folder that you want to share.
- d. In the **Users** section, select **Everyone** and set permission level to **Read & Write**.
- e. Click  to close the window.

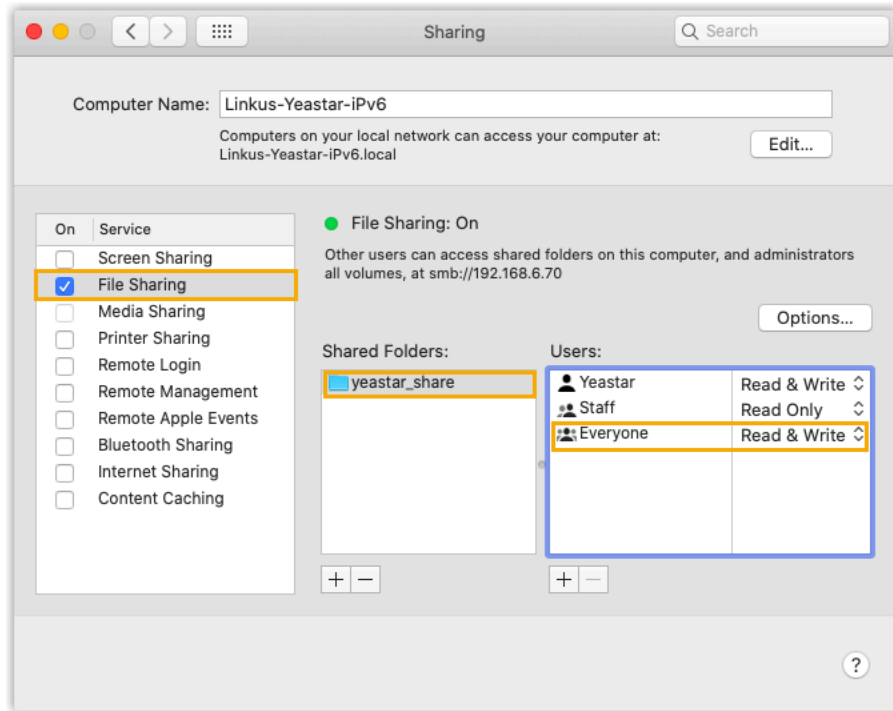

Step2. Turn off Mac firewall

Firewall on Mac is disabled by default. Follow the instructions below to ensure that the firewall is disabled, or the shared folder on the Mac may not be accessed.

1. Go to **Apple menu**  > **System Preferences** > **Security & Privacy**, click **Firewall** tab.
2. Make sure that firewall is disabled as follows.

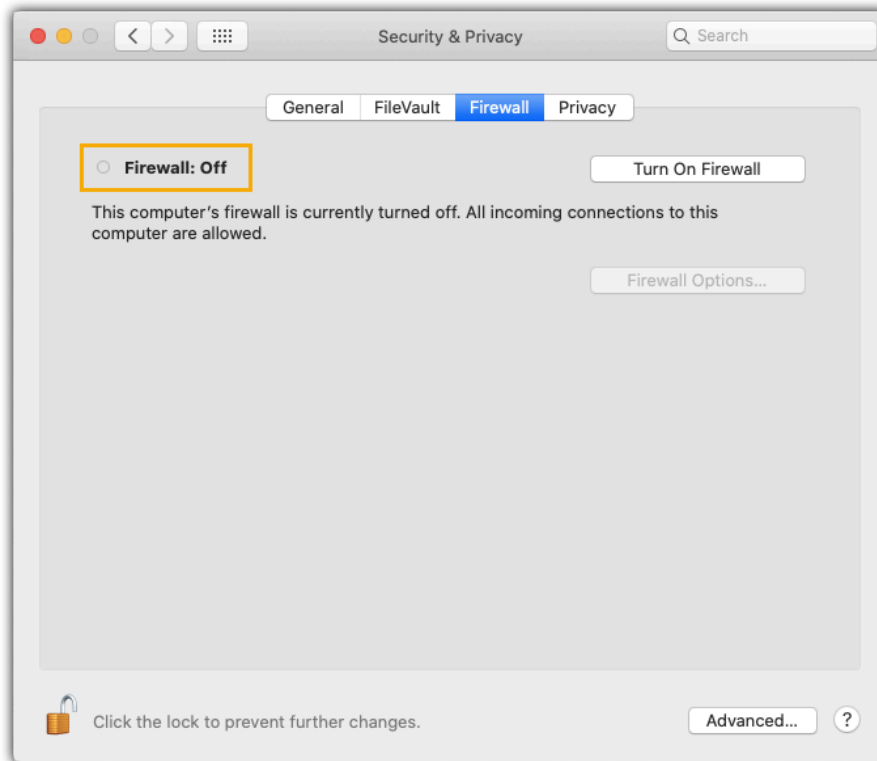

Step3. Mount the shared folder to PBX

1. Log in to the PBX web interface, go to **System > Storage > Storage Locations**.
2. In the **Storage Devices** section, click **Add Network Drive**.
3. In the pop-up window, configure the following settings.
 - **Name:** Specify a name to help you identify the network drive.
 - **Host/IP:** Enter the IP address of the Mac.
 - **Share Name:** Enter the name of the shared folder that you have created on the Mac.

 **Note:** To mount a subdirectory of the shared folder, enter subdirectory name.

 - **Access Username:** Enter the username to access the shared folder.





[How to check the username that is used to access the shared folder?](#)

 - **Access Password:** Enter the password to access the shared folder.
 - **Work Group:** Optional. If you have set work group on your network drive, enter the name of the work group. If not, leave this field blank.
 - **Samba Version:** Select the Samba version for the network drive. The default value is **Auto**.
4. Click **Save**.

Step4. Check connection status

In the **Storage Devices** section, check status of the network drive.

- **Connected:** The network drive is connected.
- **Unmounted:** No network drive is mounted.
- **Read Only:** Can NOT write data to the network drive.
- **Error**

Storage Devices						
Name	Type	Status	Total	Available	Usage	Operations
LOCAL	Local	Connected	6.14G	4.12G	<div style="width: 33%;"></div> 33%	
HD	Hard Disk	Not Inserted	0.00G	0.00G	<div style="width: 0%;"></div> 0%	
SD	SD Card	Not Inserted	0.00G	0.00G	<div style="width: 0%;"></div> 0%	
USB	USB	Connected	869.30G	665.12G	<div style="width: 23%;"></div> 23%	 
testnet55	Network Drive	Connected	65.49G	42.49G	<div style="width: 36%;"></div> 36%	 

What to do next

Decide what data will be stored on the network drive. For more information, see [Manage Storage Locations](#).

Network Drive FAQ

1. **How to check the user name that is used to access the shared folder?**
 - a. Go to **Apple menu**  > **System Preferences > Users & Groups**, check the current user name.

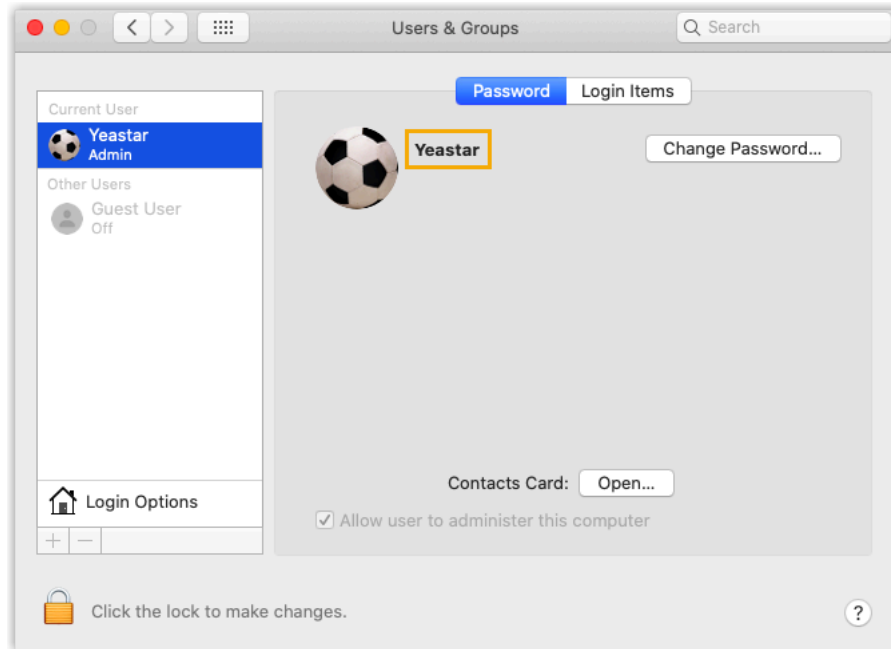

Manage Storage Locations

This topic describes how to manage storage locations for voicemail, logs, and recordings.

Prerequisites

- To store data on local disk, make sure there is enough storage space.
- To store data on external storage device or network drive, make sure the external device or network drive is connected. For more information, see the following topics:
 - # [Set up a USB Flash Drive](#)
 - # [Set up a Hard Disk Drive](#)
 - # [Set up an SD Card](#)
 - # [Add a Windows Network Drive](#)
 - # [Add a Mac Network Drive](#)

Procedure

1. Log in to the PBX web interface, go to **System > Storage > Storage Locations**.
2. In the **Storage Locations** section, set storage location for the desired data.
 - **Voicemail**: Can be stored either on local disk or external device.
 - **Recordings**: Can be stored ONLY on external device.
 - **Logs**: Can be stored either on local disk or external device.
3. Click **Save**.

Result

New data will be stored on the specified location.

What to do next

Set auto cleanup conditions for the data. For more information, see [Auto Cleanup Settings](#).

Auto Cleanup Settings

Auto Cleanup feature automatically and periodically cleans up your CDR, voicemails, recording files, backup files, and logs (including event logs, email sent logs, operation logs, and system logs). This topic describes relevant configuration parameters of auto cleanup.

CDR Auto Cleanup

Table 35.

Setting	Description
Max Number of CDR	<p>Set the maximum number of CDR that should be retained.</p> <p>When it reaches 90% of the maximum number, the Auto Cleanup Reminder event will be triggered.</p> <p>When it reaches the maximum number, the oldest CDR will be deleted.</p> <p>Default value: 200,000</p> <p>Maximum value: 500,000</p>
CDR Preservation Days	<p>Set the maximum number of days that CDR should be retained.</p> <p>When it reaches 90% of the maximum preservation days, the Auto Cleanup Reminder event will be triggered.</p> <p>When it reaches the maximum preservation days, the oldest CDR will be deleted.</p> <p>Default value: 0, which means no limit.</p>

Voicemail Auto Cleanup

Table 36.

Setting	Description
Max Number of Voicemail	<p>Set the maximum number of voicemails that should be retained.</p> <p>When it reaches 90% of the maximum number, the Auto Cleanup Reminder event will be triggered.</p> <p>When it reaches the maximum number, the oldest voicemails will be deleted.</p> <p>Default value: 100</p> <p>Maximum value: 500</p>

Table 36. (continued)

Setting	Description
Voicemail Preservation Days	<p>Set the maximum number of days that voicemails should be retained.</p> <p>When it reaches 90% of the maximum preservation days, the Auto Cleanup Reminder event will be triggered.</p> <p>When it reaches the maximum preservation days, the oldest voicemails will be deleted.</p> <p>Default value: 0, which means no limit.</p>

Recording Auto Cleanup

Table 37.

Setting	Description
Max Usage of Device (%)	<p>Set the maximum storage percentage that the device is allowed to store recording files.</p> <p>When it reaches 90% of the maximum storage percentage, the Auto Cleanup Reminder event will be triggered.</p> <p>When it reaches the maximum storage percentage, the oldest recording files will be deleted.</p> <p>Default value: 80%</p> <p>Maximum value: 90%</p>
Recordings Preservation Days	<p>Set the maximum number of days that recording files should be retained.</p> <p>When it reaches 90% of the maximum preservation days, the Auto Cleanup Reminder event will be triggered.</p> <p>When it reaches the maximum preservation days, the oldest recording files will be deleted.</p> <p>Default value: 0, which means no limit.</p>

System Backup Files

Table 38.

Setting	Description
Max Number of Files	<p>Set the maximum number of backup files that should be retained.</p> <p>When it reaches 90% of the maximum number, the Auto Cleanup Reminder event will be triggered.</p> <p>When it reaches the maximum number, the oldest backup files will be deleted.</p> <p>Default value: 5</p> <p>Maximum value: 8</p>

Event Logs Auto Cleanup

Table 39.

Setting	Description
Max Number of Logs	<p>Set the maximum number of event logs that should be retained. When it reaches the maximum number, the oldest event logs will be deleted.</p> <p> Note: Some event logs are not allowed to be automatically cleaned up. When those logs reach 5,000, the oldest event logs will be deleted.</p> <p>Default value: 50,000 Maximum value: 1,000,000</p>
Logs Preservation Days	<p>Set the maximum number of days that event logs should be retained. When it reaches the maximum preservation days, the oldest event logs will be deleted.</p> <p>Default value: 0, which means no limit.</p>

Email Sent Logs Auto Cleanup

Table 40.

Setting	Description
Max Number of Logs	<p>Set the maximum number of email sent logs that should be retained. When it reaches the maximum number, the oldest email sent logs will be deleted.</p> <p>Default value: 50,000 Maximum value: 1,000,000</p>
Logs Preservation Days	<p>Set the maximum number of days that email sent logs should be retained. When it reaches the maximum preservation days, the oldest email sent logs will be deleted.</p> <p>Default value: 0, which means no limit.</p>

Operation Logs Auto Cleanup

Table 41.

Setting	Description
Max Number of Logs	<p>Set the maximum number of operation logs that should be retained. When it reaches the maximum number, the oldest operation logs will be deleted.</p> <p>Default value: 50,000</p>

Table 41. (continued)

Setting	Description
	Maximum value: 1,000,000
Logs Preservation Days	<p>Set the maximum number of days that operation logs should be retained.</p> <p>When it reaches the maximum preservation days, the oldest operation logs will be deleted.</p> <p>Default value: 0, which means no limit.</p>

System Logs Auto Cleanup

Table 42.

Setting	Description
Max Storage of Logs (MB)	<p>Set the maximum file size for a system log package.</p> <p>When it reaches the maximum file size, the oldest logs in the package will be deleted.</p> <p>Default value: 10</p> <p>Maximum value: 50</p>
Logs Preservation Days	<p>Set the maximum number of days that a system log should be retained.</p> <p>Default value: 7</p> <p>Maximum value: 15</p>

Event Notification

Event Notification Overview

This topic describes event types, event levels, notification methods, notification email templates, and auto cleanup of events.

Event notification is designed to provide information about changes on Yeastar P-Series PBX System. You can set event notifications to monitor operations on the PBX. When an event occurs, the system will notify specific contacts via specific methods.

Event types

Yeastar P-Series PBX System supports the following event types:

- [Operation](#)
- [Telephony](#)
- [System](#)

- [Security](#)
- [Reminder](#)

Table 43. Operation

Event	Description
Administrator Login Success	The administrator successfully logged in to the PBX web interface.
Web User Login Success	A user successfully logged in to the PBX web or the Linkus Web Client.
Web User Login Failed	A user failed to log in to the PBX web or the Linkus Web Client.
Linkus Client Login Failed	An extension user failed to log in to Linkus Mobile Client or Linkus Desktop Client.
Administrator Password Changed	The administrator's password was changed.
Extension User Password Changed	An extension user's user password was changed.

Table 44. Telephony

Event	Description
SIP Trunk Registration Failed	Failed to register or connect to a SIP trunk.
SIP Trunk Re-registered	Successfully re-registered or re-connected to a SIP trunk.
Emergency Call Dialed Out	An extension user placed an emergency call.

Table 45. System

Event	Description
CPU Overload	CPU ran over 90% in 10s.
Memory Overload	Memory ran over 90% in 10s.
Abnormal D30 Module	The D30 module was abnormal.
Storage Device Failure	Failed to write data to storage device.
Insufficient Storage	The storage ran out of 90%.
Lost Connectivity to Storage Device	Lost connection to storage device.
Auto Cleanup Reminder	Reach 90% of the allowed storage limit.
New System Firmware Detected	The PBX automatically detected a new firmware version.
System Upgrade Completed	The PBX was upgraded.
System Reboot	Either of the following situations triggered the event: <ul style="list-style-type: none"> • The PBX rebooted after configuration.

Table 45. System (continued)

Event	Description
	<ul style="list-style-type: none"> The PBX automatically rebooted after system crash.
System Restore	The PBX was restored.
Yeastar SMTP Server Error	Yeastar SMTP server failed to send emails.
Abnormal License Activation	Failed to connect to extranet License Activation Server.

Table 46. Security

Event	Description
Web User Locked Out	<p>PBX blocked the source IP when either of the following situations was met:</p> <ul style="list-style-type: none"> Web Login failure for more than 5 times in 24 hours. More than 5 accounts were locked in 24 hours.
Linkus User Blocked Out	<p>PBX blocked the source IP when either of the following situations was met:</p> <ul style="list-style-type: none"> Login failure (Linkus Mobile Client or Linkus Desktop Client) for more than 5 times in 24 hours. More than 5 accounts were locked in 24 hours.
Extension Registration Blocked Out	<p>PBX blocked the source IP when either of the following situations was met:</p> <ul style="list-style-type: none"> Registration failure for more than 20 times. More than 3 accounts were locked.
Auto Defense IP Blocked Out	The monitored service or port reached the limit of Number of Packets during specific Time Interval .

Table 47. Reminder

Event	Description
Plan Expiration Reminder	The current plan will expire soon.
Video Conferencing Usage Has Reached 90% of Time Limit	Reach 90% of the annual time limit of video conferencing.
Video Conferencing Usage Limit Reached	Reach annual usage limit of video conferencing.

Event levels

When configuring an event, it is important to choose an appropriate severity level. The severity level is used to indicate how severe or important an event is. Choosing an appropriate level prevents recipients from receiving repetitive information.

Yeastar P-Series PBX System supports the following event levels:

- **Information:** Events that pass general information to recipients.
- **Warning:** Events that indicate specific components or applications are not in ideal states, and further action could result in errors.
- **Alert:** Events that indicate problems require timely attention.



Note:

- # When an event occurs, the system gives you a pop-up reminder on the right of PBX web interface.
- # For event whose default level is not **Alert**, the system will NOT give you a pop-up reminder even if you change the level from **Information** or **Warning** to **Alert**.

Notification contacts and methods

You can set event recipient to an internal user or external user, and notify user in the following ways when events occur:

- **Send Email**
- **Call Extension**
- **Call Mobile**

For more information, see [Manage Notification Contacts](#).

Notification email templates

Notification email templates allow you to create reusable content for the subject line and message body of email notifications. Yeastar P-Series PBX System provides default email template for each event, you can also customize email templates according to your needs.

For more information, see [Customize Email Templates](#).

Auto cleanup of event logs

By default, when event logs reach 50,000, the system automatically deletes the oldest logs. You can change the value, or set the maximum days that logs can be retained.

For more information, see [Auto Cleanup Settings](#).

Configure Event Notifications

This topic describes how to configure event notifications.

Procedure

1. Log in to the PBX web interface, go to **System > Event Notification > Event Type**.
2. Configure notification settings for a desired event.
 - **Event Level:** Use default level or select a level from the drop-down list.

A proper level helps you identify seriousness of an event, or quickly filter events.

 **Note:** If you change the event to another level, the event will be included in the number of new level on [Event Trend](#) when the event occurs.

- **Notification:** Decide whether to send notifications when events occur.
- **Email Template:** To customize template of the email that will be sent to relevant contacts when the event occurs, click .

Result

When the event occurs, the followings can be achieved:

- The PBX sends notifications to relevant contacts via specific notification methods.
- On [Event Trend](#) section, the event is included in the statistics of corresponding event level.
- At the top right corner of the page,  automatically adds 1 in the color that indicates the event level.

 **Note:** If default level for the event is **Error**, the system also gives you a pop-up reminder on the right of PBX web interface.

What to do next

At the top right corner, click  to check event details.

Manage Notification Contacts

This topic describes how to add, edit, or delete a notification contact.

Add a notification contact



1. Log in to the PBX web interface, go to **System > Event Notification > Notification Contacts**, click **Add**.
2. In the pop-up window, configure contact settings.
 - **Notification Contact:** Select an internal user or set an external user. If you choose **Custom**, enter a name in the **Contact Name** field.
 - **Notification Methods:** Set how to notify the contact when events occur.
 - # **Call Extension:** The PBX will call the extension number of the contact when an event occurs.
 - # **Send Email:** The PBX will send notifications to the email address of the contact when an event occurs.
 - # **Call Mobile:** The PBX will call the extension number of the contact when an event occurs.

 **Note:** To ensure that PBX can successfully call the mobile number, make sure that the **Prefix** is configured correctly according to the out-bound route rule.

- **The Event Levels to Notify:** Select the level of events that you want to notify the contact. The contact will only receive notifications when events at the level occur.
3. Click **Save**.

Edit a notification contact

1. Log in to the PBX web interface, go to **System > Event Notification > Notification Contacts**.
2. Select a desired contact, click .

 **Note:** To edit the event notifications of super administrator, click the  at the top-right corner and select **Administrator Settings**.

3. Change the notification methods and notification level according to your needs.
4. Click **Save**.

Delete notification contacts

1. Log in to the PBX web interface, go to **System > Event Notification > Notification Contacts**.
2. Delete one or more contacts according to your needs.
 - To delete a contact, click  beside the desired contact, click **OK**.
 - To delete contacts in bulk, select the checkboxes of the desired contacts, click **Delete** and **OK**.

The contacts are removed from the list, and will not receive notifications when events occur.

Manage Event Logs

All the occurred events are saved in event logs so that you can trace the events. This topic describes how to view, download, and mark event logs as read.

Procedure

1. Log in to the PBX web interface, go to **System > Event Notification > Event Logs**.
2. Set the search criteria to search events.

Event Type	Event Level	Status	Event Name	Time
Operation	● Informat	All	All	09/15/2020 00:00:00 ~ 09/15/2020 23:59:59

[Download](#)
[Mark All as Read](#)

Time	Event Type	Event Level	Event Name	Operations
09/15/2020 09:36:18	Operation	● Information	Administrator Login Success	
09/15/2020 09:34:21	Operation	● Information	Web User Login Success	
09/15/2020 09:34:09	Operation	● Information	Extension User Password Changed	
09/15/2020 09:33:44	Operation	● Information	Web User Login Success	
09/15/2020 09:33:07	Operation	● Information	Web User Login Success	

- **Event Type:** Search all the event logs or search logs by a specific event type.
- **Event Level:** Search all the event logs or search logs by a specific event level.
- **Status:** Search all the event logs or search logs by a specific acknowledgement status.
- **Event Name:** Search all the event logs or search a specific event.
- **Time:** Set the start date and end date of the events.

The matched events are displayed on the page.

3. Handle the searched events according to your needs.

- To check log details, click beside the desired event log.

The event log will be marked as read.

- To download all the searched logs, click **Download**.
- To mark all the searched logs as read, click **Mark All as Read**.

Note: At the top right corner, the number of unread events of the event level prompted on will be cleared.

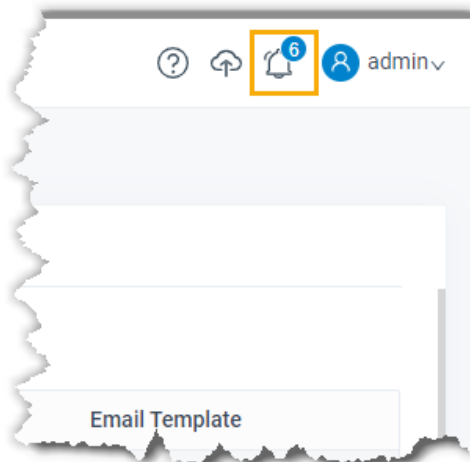

Security

Security Overview

Yeastar P-Series PBX System provides robust security options to ensure a secure and reliable phone service to your business operation, such as static defense rules, auto defense rules, IP blocking and so on.

Static defense

Static defense rules are used to control and filter traffic sent to the PBX by IP address, domain, or MAC address.

Yeastar P-Series PBX System has default static defense rules to ensure the communication among Yeastar server, Yeastar P-Series PBX System, and devices in your local network.

- **Local network**

- # 10.0.0.0/255.0.0.0
- # 172.16.0.0/255.240.0.0
- # 192.168.0.0/255.255.0.0
- # 169.254.0.0/255.255.0.0

 **Note:** These rules can NOT be edited or deleted.

- **Domain related with Yeastar**

- # update.yeastar.com
- # mgt.yeastar.com
- # stund.yeastar.com
- # cwmp.yeastar.com
- # tunnel.yeastar.com
- # appcenter.yeastar.com
- # mail.pbxsmt.com
- # active.yeastar.com

- **IP address of phones that have been auto provisioned**

You can also set up new rules to accept, drop, or reject access to the PBX. The IP address that was denied access to the PBX would be blocked when trying to connect to the PBX. You can check the blocked IP address in **Block IPs**.

For more information, see [Add a Static Defense Rule](#) and [Manage Blocked IP Addresses](#).

Auto defense

Auto defense rules are used to prevent massive connection attempts or brute force attacks. When a source address sends packets over the limit within the specified time period, the PBX will block the source address. You can check the blocked IP address in [Block IPs](#).

Yeastar P-Series PBX System has default auto defense rules as below:

Table 48.

Service	Service/Port Range	Port	Protocol	Rate
SSH	Service	8022	TCP	10/60 s
SIP UDP	Service	5060	UDP	40/2 s
SIP TCP	Service	5060	TCP	40/2 s
HTTP	Service	80	Both	120/60 s
HTTPS	Service	8088	Both	120/60 s

You can also set up new rules according to your needs.

For more information, see [Add an Auto Defense Rule](#).

Security options

The PBX provides additional options so that you can flexibly adjust your security scheme:

- **Disable Auto Defense:** If the option is enabled, the auto defense feature will not work.
- **Disable Extension Registration Defense:** If the option is enabled, the SIP security settings will not work.
- **Drop All but Accepted IPs in Static Defense:** If the option is enabled, the PBX will drop all the packets and connections from other hosts except the accepted addresses defined in static defense rules.

 **Note:** We recommend that you [create a backup on the PBX](#) before you enable the feature.

- **Drop IP Ping Request:** If the option is enabled, the PBX will disable Ping response (ICMP echo).



Static Defense

Add a Static Defense Rule

Static defense rules are used to control and filter traffic sent to Yeastar P-Series PBX System. This topic describes how to add a static defense rule.

Procedure

1. Log in to the PBX web interface, go to **Security > Security Rules > Static Defense**, click **Add**.

2. In the **Basic** section, configure basic settings for the rule.
 - **Name**: Enter a name to help you identify the rule.
 - **Description**: Optional. Add a note to the rule.
 - **Action**: Select an action for the rule.
 - # **Accept**: Accept connections from a specific address.
 - # **Drop**: Restrict a specific address from accessing a specific service or port of the PBX, and do NOT send any error notifications back to the sender.
 - # **Reject**: Restrict a specific address from accessing a specific service or port of the PBX, and send error notifications back to the sender.
3. In the **Defense Object** section, configure relevant settings of defense objects.
 - **Object Type**: Choose the type of the source traffic.
 - # **IP Address**: If you choose the option, enter an IP address or an IP section in the **Source IP Address / Subnet Mask** field.
 - # **Domain**: If you choose the option, enter a domain in the **Domain Name** field.
 - # **MAC Address**: If you choose the option, enter a MAC address in the **MAC Address** field.
 - **Service/Port Range**: Set whether the rule is applied to a specific service or a port range.
 -  **Note**: The setting is available ONLY when you set **Action** to **Drop** or **Reject**.
 - # **Service**: Select a service from the drop-down list. The defense rule will be applied to the service and the service port.
 -  **Note**: The port follows the setting in **Service Ports (System > Network)**.
 - # **Port Range**: Set a port range.
 - **Protocol**: Choose a protocol to which the rule is applied.
 - # **UDP**
 - # **TCP**
 - # **BOTH**: Both UDP and TCP.
4. Click **Save**.

Result

- For address that is allowed to access the PBX, the system will always accept connections from the address.
- For address that is restricted from accessing a specific service or port of the PBX, the system will block it when the address tries to access the service or the port.

Manage Static Defense Rules

This topic describes how to edit or delete static defense rules.

Edit a static defense rule

1. Log in to the PBX web interface, go to **Security > Security Rules > Static Defense**.
2. Select the desired rule, click .
3. Edit rule settings according to your needs.
4. Click **Save**.

Delete static defense rules

1. Log in to the PBX web interface, go to **Security > Security Rules > Static Defense**.
2. Delete one or more rules according to your needs.
 - To delete a rule, click  beside the desired rule, click **OK**.
 - To delete rules in bulk, select the checkboxes of the desired rules, click **Delete** and **OK**.

Auto Defense

Add an Auto Defense Rule

Auto defense rules are used to prevent massive connection attempts or brute force attacks. This topic describes how to add an auto defense rule.

Procedure

1. Log in to the PBX web interface, go to **Security > Security Rules > Auto Defense**, click **Add**.
2. In the **Name** field, enter a name to help you identify the rule.
3. In the **Defense Object** section, configure relevant settings of the defense object.
 - **Service/Port Range:** Set whether the rule is applied to a specific service or a port range.
 - # **Service:** Select a service from the drop-down list. The defense rule will be applied to the service and the service port.
 -  **Note:** The port follows the setting in **Service Ports (System > Network)**.
 - # **Port Range:** Set a port range.
 - **Protocol:** Choose a protocol to which the rule is applied.
 - # **UDP**
 - # **TCP**
 - # **BOTH:** Both UDP and TCP.
 - **Number of IP Packets:** The number of IP packets permitted within a specific time period.

- **Time Interval (s):** The time interval to receive IP Packets.

For example, **Number of IP Packets** is 90 and **Time Interval (s)** is 60; The PBX will block the IP that sends more than 90 IP packets in 60 seconds.

4. Click **Save**.

Result

When a source address sends packets over the limit within the specified time period, the followings can be achieved:

- The PBX blocks the IP address. You can check the details in [Blocked IPs](#).
- If you have enabled notification for **Auto Defense IP Blocked Out** event, the PBX will give you a pop-up reminder on the web interface, and notify you via a specific method.

Manage Auto defense Rules

This topic describes how to edit or delete auto defense rules.

Edit an auto defense rule

1. Log in to the PBX web interface, go to **Security > Security Rules > Auto Defense**.
2. Select the desired rule, click .
3. Edit rule settings according to your needs.
4. Click **Save**.

Delete auto defense rules

1. Log in to the PBX web interface, go to **Security > Security Rules > Auto Defense**.
2. Delete one or more rules according to your needs.
 - To delete a rule, click  beside the desired rule, click **OK**.
 - To delete rules in bulk, select the checkboxes of the desired rules, click **Delete** and **OK**.

Blocked IPs

Manage Blocked IP Addresses

This topic describes how to view or delete IP addresses that were blocked.

View blocked IP address

1. Log in to the PBX web interface, go to **Security > Security Rules > Blocked IPs**.
2. Check details of the IP address that was blocked.
 - **Defense Type:** The defense type.
 - **Block Type:** Whether an account or an IP address was blocked.
 - **Block Range:** The account range or port range that was blocked.
 - **Time of Attack:** The time that the blocked account or IP address tried to attack the system.
 - **Protocol:** The protocol that the blocked account or IP address tried to attack.
 - **Attacked Port:** The port that the blocked account or IP address tried to attack.
 - **Source IP Address:** The IP address from which the attack was originated.
 - **Expiration Date:** The date and time on which the block would expire.

Delete blocked IP address

1. Log in to the PBX web interface, go to **Security > Security Rules > Blocked IPs**.
2. Delete one or more IP addresses according to your needs.
 - To delete an IP address, click  beside the desired IP address, click **OK**.
 - To delete IP addresses in bulk, select the checkboxes of the desired IP addresses, click **Delete** and **OK**.

Console/SSH Access

Access the System via SSH

This topic takes Putty as an example to introduce you how to access Yeastar P-Series PBX System via SSH.

Procedure

1. Enable SSH, check SSH port, console account, and console password on the PBX.
 - a. Log in to the PBX web interface, go to **Security > Security Settings > Console/SSH Access**.
 - b. Enable **SSH Access**.
 - c. Check SSH port, console account, and console password.

 **Tip:** Click  to view the password.

The screenshot shows the 'Console' configuration page. It has two main sections: 'Console Account' and 'Console Password'. The 'Console Account' field contains the text 'support'. The 'Console Password' field contains 'Hsoqrw0756' and has a visibility toggle (eye icon) and a refresh icon. Below this is the 'SSH Access' section, which is currently disabled (indicated by a blue circle and a line). Underneath, the 'SSH Port' field is set to '8022'.

2. Enter access information on Putty.
 - a. In the **Connection type** field, choose **SSH**.
 - b. In the **Host Name (or IP address)** field, enter your PBX's IP address.
 - c. In the **Port** field, enter SSH port that you have configured on the PBX.
 - d. **Optional:** On the left navigation bar, click **Window > Lines of scrollbar**, set a scrollbar line number, so that you can get sufficient lines of log for debug analysis.
 - e. Click **Open**.

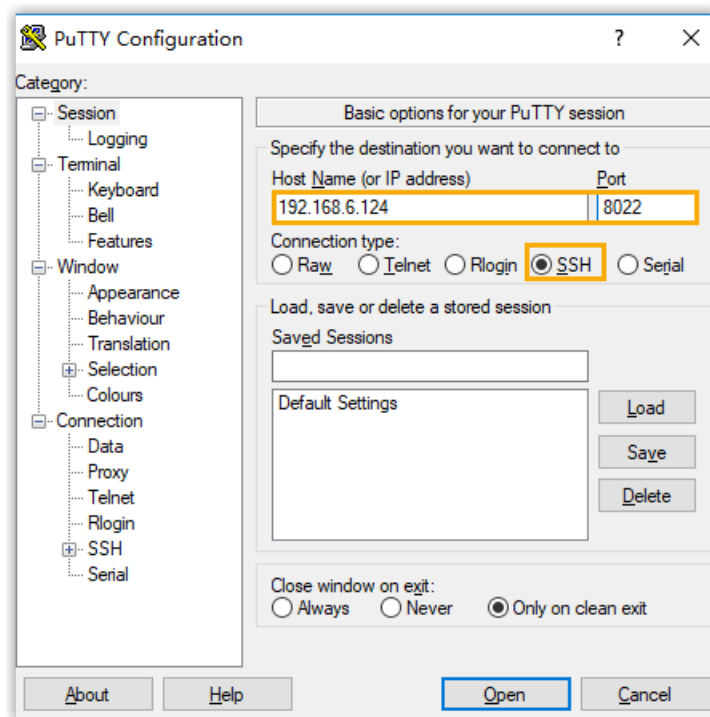

3. Verify your account and password.
 - a. In the **login as** field, enter *support*.
 - b. Copy console password from PBX.
 - c. In the password field, right click to paste the password.

Result

If the following figure shows, you can successfully access and debug the PBX.



Certificates

Upload TLS certificates to the PBX

Yeastar P-Series PBX System supports TLS protocol to secure SIP messaging. Before using TLS protocol, you may need to upload a TLS certificate.

Background information

With TLS protocol enabled on the PBX, a TLS certificate may be required in the following situations:

- When the PBX acts as a server, a server certificate is required.
If the PBX requires to verify TLS client (**PBX Settings > SIP Settings > TLS > TLS Verify Client**), you need to upload a client certificate to both PBX and TLS client, or the TLS connection would fail.
- When the PBX acts as a client, whether a client certificate is required depends on the server.
If the PBX requires to verify TLS server (**PBX Settings > SIP Settings > TLS > TLS Verify Server**), you need to upload a server certificate.

Upload a TLS server certificate

Prerequisites

You have prepared a server certificate in `.pem` format.

Procedure

1. Log in to the PBX web interface, go to **Security > Security Settings > Certificates**, click **Upload**.

A window pops up, which requires you to select certificate type and upload a certificate.

 **Note:** You can ONLY upload 3 certificates.

2. In the **Certificate Type** drop-down list, choose **PBX Certificate**.
3. Click **Browse** to select the desired certificate.
4. Click **Upload**.

Result

The certificate is uploaded successfully, and is displayed on **Certificates** list.

Upload a TLS client certificate

Prerequisites

You have prepared a client certificate in `.cer` or `.crt` format.

Procedure

1. Log in to the PBX web interface, go to **Security > Security Settings > Certificates**, click **Upload**.

A window pops up, which requires you to select certificate type and upload a certificate.

 **Note:** You can ONLY upload 20 certificates.

2. In the **Certificate Type** drop-down list, choose **Trusted Certificate**.
3. Click **Browse** to select the desired certificate.
4. Click **Upload**.

Result

The certificate is uploaded successfully, and is displayed on **Certificates** list.

Upload HTTPS Certificates to the PBX

Yeastar P-Series PBX System supports HTTPS protocol to secure SIP messaging when you access the PBX from web browser. Before using HTTPS protocol, you need to upload a PBX certificate.

Background information

When you access PBX from web browser, the PBX acts as a server and the web browser acts as a client. A certificate helps verify your PBX's IP address and secures your data transmission.

Prerequisites

You have prepared a server certificate in `.pem` format.

Procedure

1. Log in to the PBX web interface, go to **Security > Security Settings > Certificates**, click **Upload**.

A window pops up, which requires you to select certificate type and upload a certificate.

 **Note:** You can ONLY upload 3 certificates.

2. In the **Certificate Type** drop-down list, choose **PBX Certificate**.
3. Click **Browse** to select the desired certificate.
4. Click **Upload**.

Result

The certificate is uploaded successfully, and is displayed on **Certificates** list.

Delete Certificates

This topic describes how to delete one or more certificates on Yeastar P-Series PBX System.

Procedure

1. Log in to the PBX web interface, go to **Security > Security Settings > Certificates**.
2. Delete one or more certificates according to your needs.
 - To delete a certificate, click  beside the desired certificate, click **OK**.
 - To delete certificates in bulk, select the checkboxes of the desired certificates, click **Delete** and **OK**.

Result

The certificates are removed from the list.

What to do next

Reboot the system to take effect.

Maintenance

Upgrade

Check for Available Firmware Updates

This topic describes how to automatically or manually check for firmware updates.

Automatic check for firmware updates

Prerequisites

Make sure the PBX can access the Internet.



Procedure

1. Log in to the PBX web interface, go to **Maintenance > Upgrade**.
2. In the **Automatic Upgrade** section, select **Check for updates and notify me**.
3. In the **Automatically check for updates at** drop-down list, set when the system should check for new version. This can be a daily or weekly check.
4. Click **Save**.

Result

The system will regularly check for new firmware.

 **Note:** If a new firmware is detected, the followings can be achieved:

- On the top-right corner of PBX web interface,  is displayed. Click , click **What's New** to check release notes for the new version or click **Version** to go to upgrade page.

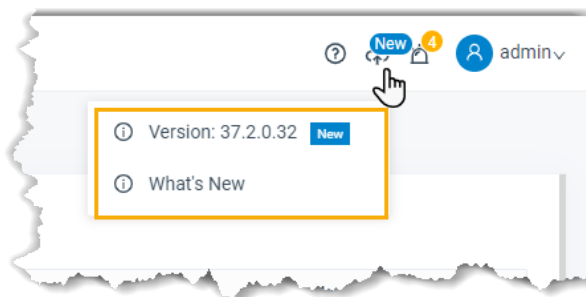

- The system will notify you via specific notification methods if you have enabled notification for **New System Firmware Detected** event.

Manual check for firmware updates

Prerequisites

Make sure the PBX can access the Internet.

Procedure

1. Log in to the PBX web interface, go to **Maintenance > Upgrade**.
2. Click **Check for the New Firmware**.

Result

If a new firmware is detected, you will find a table as below. Click the link under **Release Notes** to check what's updated in the new version, and decide whether to upgrade the firmware now.

Version	Release Notes	Upgrade
37.1.0.13	https://help.yeastar.com/en/p-series/release-notes/v37.1.0.13.html	Upgrade Now

Schedule Automatic Firmware Upgrade

This topic describes how to schedule auto detection and upgrade of new firmware.

Prerequisites

- Make sure Yeastar P-Series PBX System can access the Internet.
- We recommend that you [create a backup file](#) for PBX configurations.

Procedure

1. Log in to the PBX web interface, go to **Maintenance > Upgrade**.
2. In the **Automatic Upgrade** section, select **Check for updates and automatically install**.
3. In the **Automatically check for updates at** drop-down list, set when the system should check for and upgrade new version. This can be a daily or weekly check and upgrade.



Note: We recommend that you set a time that is beyond your office hours.

4. Click **Save**.

Result

The system will regularly compare local version with the latest version on Yeastar Firmware Server, and automatically upgrade the firmware.

Manually Upgrade PBX Firmware

This topic describes two methods to manually upgrade PBX firmware.

Manually upgrade PBX via Internet

Prerequisites

We recommend that you [create a backup file](#) for PBX configurations before you start upgrading the PBX.

Procedure

1. Log in to the PBX web interface, go to **Maintenance > Upgrade**, click **Check for the New Firmware** to check if there's a new firmware.

If the system detects a new firmware, the following table is displayed:

Version	Release Notes	Upgrade
37.1.0.13	https://help.yeastar.com/en/p-series/release-notes/v37.1.0.13.html	Upgrade Now

2. Click the **Release Notes** link to check the update details of the new version.
3. Upgrade system firmware.
 - a. Click **Upgrade Now**.

Important:

- Ensure the connection to Internet and power supply when the PBX is upgrading.
 - Make sure there aren't ongoing calls, or the calls would be disconnected.
- b. In the pop-up dialog box, click **OK**.

Result

The PBX starts upgrading the firmware.

Manually upgrade PBX via a local firmware file

Prerequisites

- Go to [Yeastar Firmware Download Center](#) to check and download the new firmware.
- We recommend that you [create a backup file](#) for PBX configurations before you start upgrading the PBX.

Procedure

1. Log in to the PBX web interface, go to **Maintenance > Upgrade > Manual Upgrade**.
2. Click **Browse** to select a firmware file.

 **Note:** The firmware file format should be `.bin`, and the file name should not contain special characters.

3. **Optional:** To reset system configurations to factory defaults, check the option **Reset Configuration to Factory Defaults**.

 **Important:** If you check the option, all your PBX configurations will be erased.

4. Click **Upgrade**.

 **Important:** When the PBX is upgrading, do NOT turn off the power, or the system will get damaged.

Result

The PBX starts uploading the file and upgrading the firmware automatically.

Backup and Restore

Overview of Backup and Restore

Yeastar P-Series PBX System supports to back up configuration data, and restore data on the same PBX or another PBX.

How Backup and Restore feature benefits your work

Yeastar P-Series PBX System integrates backup and restore feature, which helps you achieve the followings:

- Create regular and scheduled backups.
- Easy data transfer from one PBX to another.
- Quick restoration and recovery in case of system failure.

What data can be backed up

The backup feature supports to back up the following configuration data:

- **System Configuration:** All the configurations on the system.
- **Custom Prompts**
- **CDR**
- **Company Contacts**

Where backups can be stored

Backup files can be stored in the following locations:

- **Local drive:** The PBX's local drive.
- **External device:** USB flash drive, hard disk drive, and SD card.

 **Note:** Hard disk drive and SD card are ONLY supported on P560 and P570.

- **Network drive**

Backup file cleanup

By default, when the number of backup files reaches 5, the oldest files will be replaced by the newest files. You can retain the default value, or change the value according to your needs.

For more information, see [Auto Cleanup Settings](#).

Backup and restore logs

No matter who backs up or restores the PBX configuration data, you can check the operation details on PBX web interface.

For more information, see [Manage Operation Logs](#).

Create an On-Demand Backup

This topic describes how to manually back up PBX configurations.

Prerequisites

Before backing up configuration data, you need to decide the followings:

- Where - Whether to save the backup file to local drive, external device, or network drive. If you want to save the file to external device or network drive, you need to set up an external device or add a network drive on the system first. For more information, see the following topics:
 - # [Set up a USB Flash Drive](#)
 - # [Set up a Hard Disk Drive](#)
 - # [Set up an SD Card](#)
 - # [Add a Windows Network Drive](#)
 - # [Add a Mac Network Drive](#)
- What - Whether to back up custom prompts, CDR, or company contacts.

Procedure

1. Log in to the PBX web interface, go to **Maintenance > Backup and Restore**, click **Backup**.
2. Configure backup settings.

- **File Name:** Retain the default name or enter a name to help you identify it.
- **Comments:** Add a note to the backup file.
- **Storage Location:** Select a location to save the backup file.
- **The backup file will include:** Select the items that will be backed up.
 - # **System Configuration:** All the configurations on the system.
 - # **Custom Prompts**
 - # **CDR**
 - # **Company Contacts**

3. Click **Save**.

Result

The created backup file is displayed in **Backup and Restore** list and is stored in the selected location.

Set up an Automatic Backup Schedule

Yeastar P-Series PBX System supports to set up an automatic backup schedule. The system will back up the specified configuration data at the scheduled time. This topic describes how to set up an automatic backup schedule.

Prerequisites

Before backing up configuration data, you need to decide the followings:

- Where - Whether to save the backup file to local drive, external device, or network drive. If you want to save the file to external device or network drive, you need to set up an external device or add a network drive on the system first. For more information, see the following topics:
 - # [Set up a USB Flash Drive](#)
 - # [Set up a Hard Disk Drive](#)
 - # [Set up an SD Card](#)
 - # [Add a Windows Network Drive](#)
 - # [Add a Mac Network Drive](#)
- What - Whether to back up custom prompts, CDR, or company contacts.
- When - Make a daily, weekly, or monthly backup.

Procedure

1. Log in to the PBX web interface, go to **Maintenance > Backup and Restore**, click **Backup Schedule**.
2. In the pop-up window, enable **Backup Schedule**.
3. Configure an automatic backup schedule.
 - a. Set the automatic backup period. This can be a daily, weekly, or monthly backup.
 - **Frequency:** Choose to make a daily, weekly, or monthly backup.

Daily: If you choose the option, select a time from the drop-down list. The system backs up the settings at this time of the day.

Weekly: If you choose the option, choose a day of week and select a time from the drop-down list. The system backs up the settings at this time of the week.

Monthly: If you choose the option, choose a day and select a time from the drop-down list. The system backs up the settings on this day and time of the month.

 **Note**: If you set the day to **31**, but the month only has 29 or 30 days, the system will not make a backup.

b. In the **Storage Location** drop-down list, select where you want to save the backup file.

 **Note**: To prevent backup failure in case of disconnection to external device or network drive, we recommend that you save the backup file on the local flash (LOCAL).

c. In the **The backup file will include** section, choose the items that will be backed up.

- **System Configuration**: All the configurations on the system.
- **Custom Prompts**
- **CDR**
- **Company Contacts**

4. Click **Save**.

Result

The system will back up the specified configuration data at the scheduled time. The automatic generated backup file will be displayed in the **Backup and Restore** list.

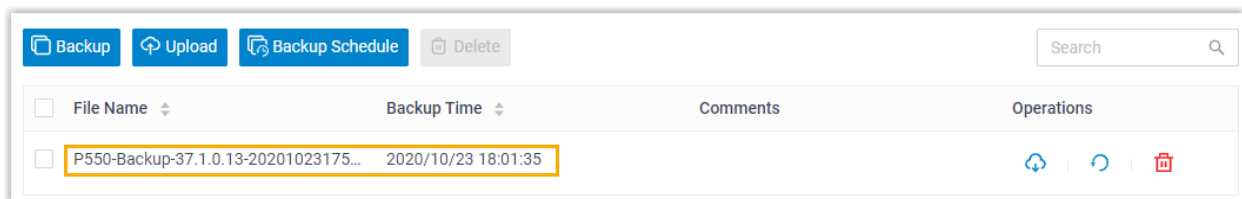

Restore Your System from a Backup

In case of data loss or system failure, you can restore the PBX from a backup. This topic describes how to restore data on the PBX.

Prerequisites

- Make sure that you have backed up system configurations and required files, such as custom prompts and CDR.
- Read and understand restrictions for data restoration.

You can restore a backup file that is created from an older version of PBX.

Example: Restoring a backup file (v37.1.0.10) to PBX (v37.1.0.13) would work.

You can NOT restore a backup file that is created from a newer version of PBX.

Example: Restoring a backup file (v37.1.0.13) to PBX (v37.1.0.10) would not work.

Procedure

1. Log in to the PBX web interface, go to **Maintenance > Backup and Restore**.
2. Select a backup file to which you want to restore, click .
3. In the pop-up dialog box, click **OK**.
4. Reboot the PBX to take effect.

Result

The current configurations on your PBX are OVERWRITTEN with the backup data.

Related information

[Create an On-Demand Backup](#)

[Set up an Automatic Backup Schedule](#)

Restore Another System from a Backup

In case you have two PBXs of different models, and you want to replace one with the other, you can restore configuration data on the other PBX. This topic describes how to upload a backup file and restore configuration data on another PBX.

Prerequisites

- Make sure that you have backed up and downloaded the required configuration data.
- Read and understand restrictions for data restoration.

You can restore a backup from a PBX with lower model number onto a PBX with higher model number.

Example: Restoring a backup file (created on P550) to P560 would work.



You can NOT restore a backup from a PBX with higher model number onto a PBX with lower model number.

Example: Restoring a backup file (created on P560) to P550 would not work.

Procedure

1. Upload a backup file.
 - a. Log in to the PBX web interface, go to **Maintenance > Backup and Restore**.
 - b. Click **Upload**.

- c. In the pop-up window, select a backup file and add a note according to your needs.
 - i. Click **Browse** to select a backup file.

 **Note:** The file format should be `.bak` and the file name should NOT contain special characters.
 - ii. **Optional:** In the **Comments** field, add a note.
 - d. Click **Upload**.
2. Restore the backup file.
 - a. In the **Backup and Restore** list, select the file that you want to restore, click .
 - b. In the pop-up dialog box, click **OK**.
 - c. Reboot the PBX to take effect.

Result

The current configurations on your PBX are OVERWRITTEN with the backup data.

Related information

[Create an On-Demand Backup](#)

[Set up an Automatic Backup Schedule](#)

Reboot

Reboot the System on Web Interface

This topic describes how to reboot Yeastar P-Series PBX System on web interface.

Prerequisites

Make sure there aren't ongoing calls, or the calls would be disconnected.

Procedure

1. Log in to the PBX web interface, go to **Maintenance > Reboot**.
2. In the **Reboot Now** section, click **Reboot Now**.
3. In the pop-up dialog box, click **Yes** to reboot the PBX.

Result

It takes about one minute to reboot the system.

If you have enabled notification for **System Reboot** event, the system will inform relevant contacts of the reboot via specific notification methods.

Schedule Automatic Reboot

To ensure the stability and robustness of Yeastar P-Series PBX System, you can schedule automatic reboot of the PBX. This topic describes how to schedule a daily, weekly, or monthly reboot of Yeastar P-Series PBX System.

Procedure

1. Log in to the PBX web interface, go to **Maintenance > Reboot**.
2. In the **Reboot Schedule** section, select the checkbox of **Enable Auto Reboot**.
3. Set when to perform an auto reboot.

 **Note:** We recommend that you set a time that is beyond your office hours.

- **Daily:** If you choose the option, select a time from the drop-down list of **Time**.

The system will daily reboot itself at this time.

- **Weekly:** If you choose the option, select a day of week from the drop-down list of **Weekly**, and select a time from the drop-down list of **Time**.

The system will weekly reboot itself at this time.

- **Monthly:** If you choose the option, select a day from the drop-down list of **Daily**, and select a time from the drop-down list of **Time**.

The system will monthly reboot itself on the day and time.

 **Note:** If you set **Daily** to 31, but the month only has 28, 29 or 30 days, the system will NOT reboot itself automatically.

4. Click **Save**.

Reset

Reset the System on Web Interface

This topic describes how to reset Yeastar P-Series PBX System on web interface.

Prerequisites

- Make sure there aren't ongoing calls, or the calls would be disconnected.
- We recommend that you [create a backup file](#) for PBX configurations.

Procedure

1. Log in to the PBX web interface, go to **Maintenance > Reset**.
2. Set which configurations and data that you want to clear.
 - **Reset All:** Clear all the configurations and data on the PBX.

- **Reset Network Settings:** Reset the PBX's IP address to **192.168.5.150**, and the configurations of **Network > Basic Settings** and **Network > Public IP and Ports** will be reset.
- **Reset CDR:** Clear all call logs.
- **Reset Backup Files:** Clear backup files.
- **Reset Prompts:** Clear custom prompts.

 **Note:** Whether the option is enabled or not, system prompts, music on hold, and preference settings for all the prompts would be cleared.

- **Reset Contacts:** Clear company contacts and Caller ID match settings.
 - **Reset Other System Configurations:** Reset all the logs and configurations except network, CDR, backup files, and prompts.
3. Click **Factory Reset**.
 4. In the pop-up dialog box, verify your operation and click **Yes**.

Result

It takes several minutes to reset the PBX. After resetting, you are redirected to the Installation Wizard page.

What to do next

Follow the [Installation Wizard](#) to set up the PBX.

Operation Logs

Operation Logs Overview

This topic describes what are operation logs, what operations are recorded, and introduces the storage and auto cleanup of operation logs.

What are operation logs

Operation logs record successful operations performed on Yeastar P-Series PBX System, and provide you with the followings to help you monitor and analyze the causes of systems errors or other types of problems.

- **Who:** Check who performed the operation. You can query all users' operations, or query operations by administrator or a specific extension.
- **When:** Check when the operation was performed. You can query operations by specific date and time.
- **What:** Check what operation was performed.
- **Where:** Check on which module the operation was performed. You can query operations by a specific module.

Storage of operation logs

Operation logs are saved in local storage, you can NOT change the storage location.

Auto cleanup of operation logs

By default, when operation logs reach 50,000, the system automatically deletes the oldest logs. You can change the value, or set the maximum days that logs can be retained. For more information, see [Auto Cleanup Settings](#).

 **Note:** A few logs related with system security and user privacy are RETAINED so that Yeastar Support can help you troubleshoot problems when toll fraud happens or PBX suffers from attack.

The operation logs that will NOT be automatically cleaned up are as follows:

Table 49.

Event Type	Event
Operation	Administrator Login Success
	Administrator Password Changed
	Web User Login Success
	Web User Login Failed
	Linkus Client Login Failed
	Extension User Password Changed
Telephony	Emergency Call Dialed Out
System	Yeastar SMTP Server Error
Security	Web User Locked Out
	Linkus User Blocked Out
	Extension Registration Blocked Out
	Auto Defense IP Blocked Out

Manage Operation Logs

This topic describes how to view and download operation logs on Yeastar P-Series PBX System.

View operation logs

1. Log in to the PBX web interface, go to **Maintenance > Operation Logs**.
2. Set the filter criteria.
 - **User:** Query all users' operations, or query operations by administrator or a specific extension.

- **Module:** Query operations on all modules, or query operations by a specific module.
 - **IP Address:** Query operations by the originated IP address.
 - **Time:** Query operations by specific date and time.
3. **Optional:** Click  beside the desired log to check operation details.

Download operation logs

1. Log in to the PBX web interface, go to **Maintenance > Operation Logs**.
2. To download all the operation logs, click **Download**.
3. To download the filtered operation logs, set [the filter criteria](#), click **Download**.

Logs are exported to a CSV file.

Troubleshooting

Capture Network Packet

This topic describes how to capture packets on LAN port, WAN port, or loopback address of your local network interface card (NIC).

Background information

Ethernet Capture Tool may be required to capture packets in the following situations:

- Extension registration failure.
- No audio or one-way audio during a call.
- Occasional VoIP interconnection failure.

Procedure

1. Log in to the PBX web interface, go to **Maintenance > Troubleshooting > Ethernet Capture Tool**.
2. In the **Ethernet Interface** drop-down list, set where you want to capture packets.
 - **Any:** Capture the packets on LAN port, WAN port, and loopback address (127.0.0.1) of your local network interface card (NIC).
 - **LAN:** Capture the packets on LAN port.
 - **WAN:** Capture the packets on WAN port.
3. **Optional:** In the **IP Address** field, enter an IP address. The system will only capture packets that travel to or from the IP address.

 **Note:** If you don't set an IP address, the PBX will capture packets for all the IP addresses.

4. **Optional:** In the **Port** field, enter a port. The system will only capture packets that go through the port.

 **Note:** If you don't set a port, the PBX will capture packets for all the ports.

5. Click **Start**.

The PBX starts to capture the Ethernet packet. During the time period, you should reproduce the problem of your VoIP trunks or extensions.

6. Click **Stop** to stop capturing.

The packets are intercepted and saved on PBX's local disk.

7. Click **Download** to download the captured packet.

What to do next

Decompress the `.tar` file and use [Wireshark](#) software to open the packet file.

Use IP Ping Tool to Diagnose Network Issues

This topic describes how to use IP Ping tool to test if Yeastar P-Series PBX System can reach a specific hostname or IP address, and introduces the test result.

Background information

Based on the Internet Control Message Protocol (ICMP), IP Ping is a network tool to determine if a destination server is accessible and estimate how long a packet takes to send and receive data from the server.

If you are suffering from the followings, you can use IP Ping to diagnose:

- Network issues.

For example, if you can not make calls, you can use IP Ping to check if the PBX can access external network.

- Poor VoIP call quality.

For example, if you are experiencing echo, buzzing, or latency during a call, you can use IP Ping to check jitter and latency, or if there are any packet loss.

Procedure

1. Log in to the PBX web interface, go to **Maintenance > Troubleshooting > IP Ping**.
2. In the **Target Host** field, enter the target domain or IP address.
3. Click **Start**.
4. Click **Stop** as your need.

Read the output

Example1: A successful Ping

```

start...
PING 192.168.6.11 (192.168.6.11): 56 data bytes
64 bytes from 192.168.6.11: seq=0 ttl=64 time=8.853 ms
64 bytes from 192.168.6.11: seq=1 ttl=64 time=0.778 ms
64 bytes from 192.168.6.11: seq=2 ttl=64 time=1.394 ms

--- 192.168.6.11 ping statistics ---
3 packets transmitted, 3 packets received, 0% packet loss
round-trip min/avg/max = 0.778/3.675/8.853 ms

```

The above example shows the followings:

- The device sends 3 ping packets and receives response for all the 3 packets.
- The ping packets' size are 64 bytes.
- The TTL value is 64, which indicates that packets are always forwarded to the same region.
- The time indicates that how long it takes to receive an Echo Response message after an Echo Request message is sent. This parameter can be used as a reference to determine whether the network is congested.

Example2: A failed Ping

```

start...
PING 192.168.7.2 (192.168.7.2): 56 data bytes

--- 192.168.7.2 ping statistics ---
60 packets transmitted, 0 packets received, 100% packet loss

```

The above example indicates that there is an issue of either the connection or the target device.

Use Traceroute Tool to Diagnose Network Issues

This topic describes how to use Traceroute tool to trace routes to a specific hostname or IP address, and introduces test results.

Background information

Traceroute is a network tool that tracks the gateways that packets pass through from Yeastar P-Series PBX System to a destination server and helps you check network connectivity and locate network faults.

If a website is inaccessible or loads lower than usual, you can use Traceroute to determine where the longest delays occur.

Procedure

1. Log in to the PBX web interface, go to **Maintenance > Troubleshooting > Traceroute**.
2. In the **Target Host** field, enter the target domain or IP address.
3. Click **Start**.

The PBX starts to trace routes to the target domain or IP address.

4. Click **Stop**, or the traceroute will terminate automatically when completed.

Read the output

Example1: A good traceroute

```

start...
traceroute to www.baidu.com (36.152.44.95), 30 hops max, 46 byte
packets
 1 * * *
 2 * * *
 3 192.168.1.1 (192.168.1.1) 1.853 ms 11.642 ms 19.951 ms
 4 110.80.36.161 (110.80.36.161) 3.008 ms 2.966 ms 3.943 ms
 5 61.154.238.133 (61.154.238.133) 7.369 ms 27.982 ms 7.808
ms
 6 117.30.27.177 (117.30.27.177) 6.125 ms 117.30.24.213 (117.
30.24.213) 4.664 ms 4.376 ms
 7 202.97.36.117 (202.97.36.117) 26.446 ms 202.97.64.178 (202
.97.64.178) 22.534 ms 202.97.79.33 (202.97.79.33) 20.897 ms
 8 202.97.63.18 (202.97.63.18) 33.276 ms 202.97.76.238 (202.9
7.76.238) 36.685 ms 202.97.18.46 (202.97.18.46) 33.961 ms
 9 * * *
10 * * *
11 * * *
12 * * *
13 * * *
14 221.183.14.14 (221.183.14.14) 40.599 ms 221.183.18.2 (221.
183.18.2) 54.233 ms
15 21.22.207.183.static.js.chinamobile.com (183.207.22.21) 43.
056 ms 53.602 ms 50.481 ms
16 122.23.207.183.static.js.chinamobile.com (183.207.23.122) 4
7.251 ms 126.23.207.183.static.js.chinamobile.com (183.207.23.1
26) 47.401 ms 110.23.207.183.static.js.chinamobile.com (183.20
7.23.110) 54.380 ms
17 * * *
18 * * *
19 * * *
20 * * *
21 * * *
22 * * *
23 202.97.23.149 (202.97.23.149) 14.133 ms * 202.97.23.157 (
202.97.23.157) 28.851 ms
24 61.154.238.69 (61.154.238.69) 7.096 ms 117.30.24.213 (117.
30.24.213) 4.682 ms 117.30.27.189 (117.30.27.189) 2.758 ms

```

```

25 113.96.4.170 (113.96.4.170) 14.663 ms 113.96.5.118 (113.96
.5.118) 17.857 ms 113.96.4.190 (113.96.4.190) 20.665 ms
26 * * *
27 * * *
28 * * *
29 110.80.36.161 (110.80.36.161) 4.278 ms 2.696 ms 3.900 ms
30 61.154.238.133 (61.154.238.133) 11.424 ms 4.690 ms 7.770
ms

```

The above example displays in the format of `HOP Domain Name (IP Address) RTT1 RTT2 RTT3`.

- **Hop:** Whenever a packet is passed between a router, this is referred to as a “hop.” For example, in the output above, we can see that it takes 14 hops to reach **www.baidu.com** from the current location.
- **Domain Name [IP Address]:** The domain name, if available, often helps you see the location of a router. If this is unavailable, only the IP address of the router is displayed.
- **RTT1, RTT2, RTT3:** This is the round-trip time that it takes for a packet to get to a hop and back to your computer (in milliseconds). This is often referred to as latency, and is the same number you see when using ping. Traceroute sends three packets to each hop and displays each time, so you have some idea of how consistent (or inconsistent) the latency is. If you see a * in some columns, you didn’t receive a response - which could indicate packet loss.

Example2: A failed hop

```

start...
traceroute to www.baidu.com (14.215.177.38), 30 hops max, 46 byte
packets
 1 * * *
 2 * * *
 3 192.168.1.1 (192.168.1.1) 1.702 ms 4.912 ms 1.873 ms
 4 110.80.36.161 (110.80.36.161) 16.068 ms 2.642 ms 2.705 ms
 5 61.154.238.129 (61.154.238.129) 5.405 ms 61.154.238.133 (6
1.154.238.133) 9.038 ms 61.154.238.129 (61.154.238.129) 4.084
ms
 6 117.30.27.185 (117.30.27.185) 3.183 ms 117.30.24.213 (117.
30.24.213) 5.256 ms 29.543 ms
 7 202.97.19.125 (202.97.19.125) 23.899 ms 202.97.23.153 (202
.97.23.153) 15.059 ms 202.97.21.69 (202.97.21.69) 12.542 ms
 8 113.96.4.130 (113.96.4.130) 20.978 ms 113.96.4.54 (113.96.
4.54) 17.600 ms 113.96.4.102 (113.96.4.102) 18.980 ms
 9 113.96.4.209 (113.96.4.209) 18.324 ms 25.160 ms 106.96.13
5.219.broad.fs.gd.dynamic.163data.com.cn (219.135.96.106) 29.13
5 ms
10 14.29.117.242 (14.29.117.242) 22.918 ms 121.14.67.150 (121
.14.67.150) 15.187 ms 14.215.32.126 (14.215.32.126) 15.963 ms
11 * * *

```

```

12 * * *
13 * * *
14 * * *
15 * * *
16 * * *
17 * * *
18 * * *
19 * * *
20 * * *
21 * * *
22 * * *
23 * * *
24 * * *
25 * * *
26 * * *
27 * * *
28 * * *
29 * * *
30 * * *

```

In the above example, hop1 and hop2 do not respond to the request, but they forward traffic to hop3. The test fails at hop11, and continues to fail all the way to hop30 (the max hops).

Example3: A routing loop

```

start...
traceroute to 192.168.8.127 (192.168.8.127), 30 hops max, 46 byte
packets
 1  192.168.8.127 (192.168.8.127)  1.725 ms  1.455 ms  1.343 ms
 2  192.168.8.127 (192.168.8.127)  1.702 ms  4.912 ms  1.873 ms
 3  192.168.8.128 (192.168.8.128)  1.068 ms  2.642 ms  2.705 ms
 4  192.168.8.127 (192.168.8.127)  3.183 ms  5.256 ms  9.543 ms
 5  192.168.8.128 (192.168.8.128)  2.978 ms  1.600 ms  1.980 ms

```

In the above example, a loop occurs between 192.168.8.127 and 192.168.8.128. Data will pass back and forth from one to the other until the session times out or the maximum hop limit is reached.

Troubleshoot and Monitor Analog Ports

If there is a problem on the FXO port, FXS port, or GSM/3G/4G channel, you can use the Port Monitor Tool to monitor the port, and download the packet to analyze it.

Procedure

1. Log in to the PBX web interface, go to **Maintenance > Troubleshooting > Port Monitor Tool**.
2. Choose the **Port** that has a problem.

3. Click **Start**.

The PBX will start to monitor the port. During this time, you should duplicate the problem of the port.

4. Click **Stop** to stop monitoring.
5. Click **Download** to download the file.

What to do next

Decompress the `.tar` file and use Audition software to open the `.raw` file and analyze it.

System Logs

System Logs Overview

This topic describes what are system logs, which level's logs are recorded, and introduces the storage and auto cleanup of system logs.

What are system logs

System logs are log files that contain information about system activities, which helps you troubleshoot and debug the system. The daily-generated system logs provide a variety of logs of different levels. The supported levels of logs are as follows:

- **Information:** Basic information.
- **Notice:** Notice information.
- **Warning:** Warning information.
- **Error:** Error information.
- **DTMF:** DTMF information.
- **Time Log:** Add time stamp of system logs.
- **Debug:** Debug information.
 - # **Enable SIP Debug**
 - # **Enable RTP Debug**
 - # **Enable BRI Debug**
 - # **Enable SS7/PRI Debug**

 **Note:** The feature is ONLY supported on P560 and P570.

Storage of system logs

System logs are saved in local storage, you can NOT change the storage location.

Auto cleanup of system logs

By default, the system automatically deletes the oldest system logs every 7 days, or when logs reach 10MB. You can change the maximum file size or days that logs can be retained. For more information, see [Auto Cleanup Settings](#).

Configure Log Level

Yeastar P-Series PBX System allows you to configure log level to gather only information that you consider important. This topic describes how to configure log level.

Procedure

1. Log in to the PBX web interface, go to **Maintenance > System Logs**.
2. Click **Log Level**.
3. In the pop-up window, decide which level's logs that you want to trace.
 - **Information**: Basic information.
 - **Notice**: Notice information
 - **Warning**: Warning information.
 - **Error**: Error information.
 - **DTMF**: DTMF information.
 - **Time Log**: Add time stamp of system logs.
 - **Debug**: Debug information.

Enable SIP Debug

Enable RTP Debug

Enable BRI Debug

 **Note**: To enable the feature, you must select the checkbox of **Information**.

Enable SS7/PRI Debug

 **Note**: The feature is ONLY supported on P560 and P570.

4. Click **Save** and **Apply**.

Result

The system will generate logs of the specified levels every day.

Manage System Logs

This topic describes how to download or delete system logs on Yeastar P-Series PBX System.

Download system logs

1. Log in to the PBX web interface, go to **Maintenance > System Logs**.

2. Download one or more system logs according to your needs.

- To download a system log, click  beside the desired log.
- To bulk download system logs, select the checkboxes of the desired logs, click **Download**.

The desired logs are downloaded and compressed into a `.tar` file.

 **Tip:** You can decompress the file and open logs by **Notepad++** or other editor software.

Delete system logs

1. Log in to the PBX web interface, go to **Maintenance > System Logs**.
2. To delete a system log, click  beside the desired log.
3. To bulk delete system logs, select the checkboxes of the desired logs, click **Delete**.

CDR and Reports

CDR

Call Detail Record (CDR) Overview

The Call Detail Record (CDR) feature provides information about calls over Yeastar P-Series PBX System. This topic describes parameters and auto cleanup of CDR.

CDR parameters

A CDR contains the following information:

- **ID:** A unique identifier for each call.
- **Time:** When the call was made or received.
- **Call From:** The number or the name of the caller.
- **Call To:** The number or the name of the callee.
- **Call Duration:** The time between the call started and the call ended.
- **Ring Duration:** The time between the call started and the call answered.
- **Talk Duration:** The time between the call answered and the call ended.
- **Status:** Call status.
 - # **ANSWERED**
 - # **NO ANSWER**
 - # **BUSY**
 - # **FAILED**
 - # **VOICEMAIL**
- **Reason:** The reason why the call was ended.
- **Source Trunk:** The call was received via which trunk.
- **Destination Trunk:** The call was sent out via which trunk.
- **Communication Type:**
 - # **Internal**
 - # **Outbound**
 - # **Inbound**
- **DID/DDI:** The phone number that the caller dialed.
- **Outbound Caller ID:** The phone number that was displayed on the callee's phone.
- **Caller IP Address:** The IP address of the caller's device.

CDR auto cleanup

By default, when the number of call logs reaches 200,000, the system automatically deletes the oldest call logs. You can change the maximum value, or you can also set the maximum preservation days.

 **Note:** Relevant recordings are retained.

For more information, see [Auto Cleanup Settings](#).

Manage CDR

This topic describes how to view, download, and delete call logs.

View CDR

1. Log in to the PBX web interface, go to **Reports and Recordings > CDR**.
2. **Optional:** Set the basic filter criteria.

- **Time:** Set the start date and the end date.

To specify a time period, click **select time** to set the start time and the end time.

- **Call From:** Set the caller's number or name.
- **Call To:** Set the callee's number or name.

 **Tip:** To swap the callee for the caller, click .

- **Status:** Select a call status.

All
 # **ANSWERED**
 # **NO ANSWER**
 # **BUSY**
 # **FAILED**
 # **VOICEMAIL**

3. **Optional:** Set the advanced filter criteria.

a. Click .

b. On the **Filter** page, set the advanced criteria.

- **Extension Group:** Select an extension group. The system only queries group members' calls.
- **Ring Duration:** Set how long the callee's phone rang before the call was answered.

 **Note:** Only numbers, =, <, <=, >, and >= are allowed.

- **Talk Duration:** Set the time between the call was answered and the call was ended.

 **Note:** Only numbers, =, <, <=, >, and >= are allowed.

- **Status:** Select call status.



All
 # **ANSWERED**
 # **NO ANSWER**
 # **BUSY**
 # **FAILED**
 # **VOICEMAIL**

- **Communication Type:** Select a type.

- # All
- # Internal
- # Outbound
- # Inbound

- **ID:** Enter the unique identifier for a call.
- **Trunk:** Select a trunk, which specifies the source or the destination trunk that the call went through.
- **Enable Number Fuzzy Search:** Set whether to search for the fuzzy equivalent for the phone number.

- c. Scroll up to click  to close the window.
The filtered call logs are displayed on the page.

 **Note:** You can click  to decide which item will be displayed.

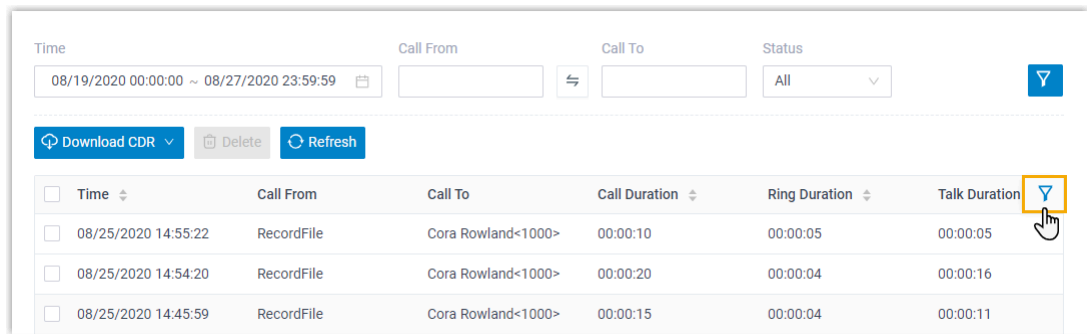

Time	Call From	Call To	Status
08/19/2020 00:00:00 ~ 08/27/2020 23:59:59			All

Time	Call From	Call To	Call Duration	Ring Duration	Talk Duration
<input type="checkbox"/> 08/25/2020 14:55:22	RecordFile	Cora Rowland<1000>	00:00:10	00:00:05	00:00:05
<input type="checkbox"/> 08/25/2020 14:54:20	RecordFile	Cora Rowland<1000>	00:00:20	00:00:04	00:00:16
<input type="checkbox"/> 08/25/2020 14:45:59	RecordFile	Cora Rowland<1000>	00:00:15	00:00:04	00:00:11

Download CDR

1. Log in to the PBX web interface, go to **Reports and Recordings > CDR**.
2. To download all the call logs, select **Download All CDR** from the drop-down list of **Download CDR**.
3. To download the filtered call logs, [set the filter criteria](#) and select **Download Filtered CDR** from the drop-down list of **Download CDR**.

Call logs are exported to a CSV file.

Delete CDR

1. Log in to the PBX web interface, go to **Reports and Recordings > CDR**.
2. **Optional:** [Filter call logs](#).
3. Select the checkboxes of the desired call logs, click **Delete** and **OK**.

 **Important:** The relevant recording files will also be deleted.

Both call logs and recording files are deleted.

Call Report

Call Reports Overview

Yeastar P-Series PBX System provides intuitive visual call reports, which allow you to check call statistics of different objects, such as extensions, trunks, queues, ring groups, etc. This topic describes category of call reports, and methods of getting an instant or a scheduled call report.

Category of Call Reports

Yeastar Call Reports are categorized as **Basic Reports** and **Advanced Reports**. Which reports are accessible depends on the plan that your PBX supports.

Table 50.

Category	Description	Requirement
Basic Reports	Reports related with extensions, trunks, and DID/Outbound Caller ID activity. <ul style="list-style-type: none"> • Extension Call Statistics • Extension Call Activity • Trunk Activity • DID/Outbound Caller ID Activity 	No additional requirement.
Advanced Reports	Reports related with queues and ring groups. <ul style="list-style-type: none"> • Queue AVG Waiting & Talking Time • Queue Performance • Satisfaction Survey • Agent Login Activity • Agent Pause Activity • Agent Missed Call Activity • Agent Call Summary • Ring Group Statistics 	Require subscription to Yeastar P-Series Enterprise Plan or Ultimate Plan

Methods of getting an instant report or a scheduled report

Yeastar P-Series PBX System allows you to have an instant search and view of call reports on the PBX's web interface, or schedule call reports to be sent to your mailbox at the specified time and download the reports to your local device.

For more information about searching and viewing call reports on the PBX's web interface, see [View Call Reports](#).

For more information about scheduling call reports, see [Schedule Call Reports](#).

Call Reports

Extension Call Statistics Report

Extension Call Statistics Report is a summary report displayed in pie chart, which makes it possible for you to query statistics of calls that have been made or received by a specific extension or extensions within a specific group, and view percentage and proportional data of call statistics.

Report details

The following table lists the related parameters for Extension Call Statistics report.

Parameter	Description
Answered	The total number of calls that the extension answered.
No Answered	The total number of calls that were routed to the designated destination when the extension didn't answer the calls.
Busy	The total number of calls that were routed to the designated destination when the extension was busy.
Failed	The total number of calls that were failed to be made by the extension.
Voicemail	The total number of voicemails that the extension received.
Total Ring Duration	The total time between calls started and calls answered.
Total Talk Duration	The total time between calls answered and calls ended.

Report example

The following report shows internal call statistics of all the extensions in group **Default_AI-I_Extensions** during **2021/01/15 00:00:00-2021/01/15 23:59:59**.

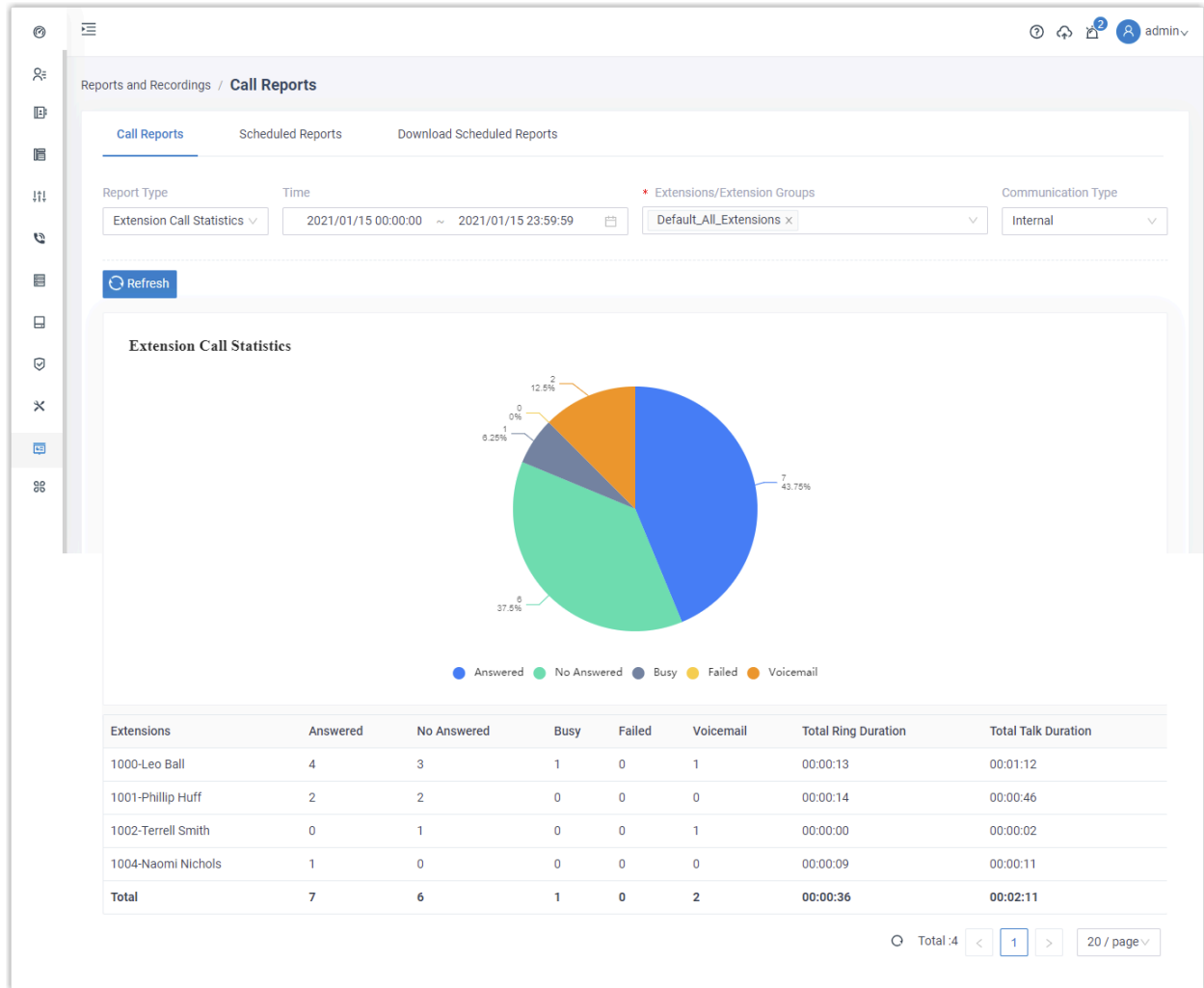

Extension Call Activity Report

Extension Call Activity Report is a summary report displayed in line graph, which makes it possible for you to query statistics of calls that have been made or received by a specific extension or extensions within a specific group. The report allows you to track changes of call activity over a specific period of time, or compare changes over the same period of time.

Report details

The following table lists the related parameters for Extension Call Activity report.

Parameter	Description
Answered	The total number of calls that the extensions answered.
No Answered	The total number of calls that were routed to the designated destination when the extensions didn't answer the calls.

Parameter	Description
Busy	The total number of calls that were routed to the designated destination when the extensions were busy.
Failed	The total number of calls that were failed to be made by the extensions.
Voicemail	The total number of voicemails that the extensions received.
Total Ring Duration	The time between the call started and the call answered.
Total Talk Duration	The time between the call answered and the call ended.

Report example

The following report shows daily inbound call statistics of all the extensions in group **Default_All_Extensions** on September, 2020.

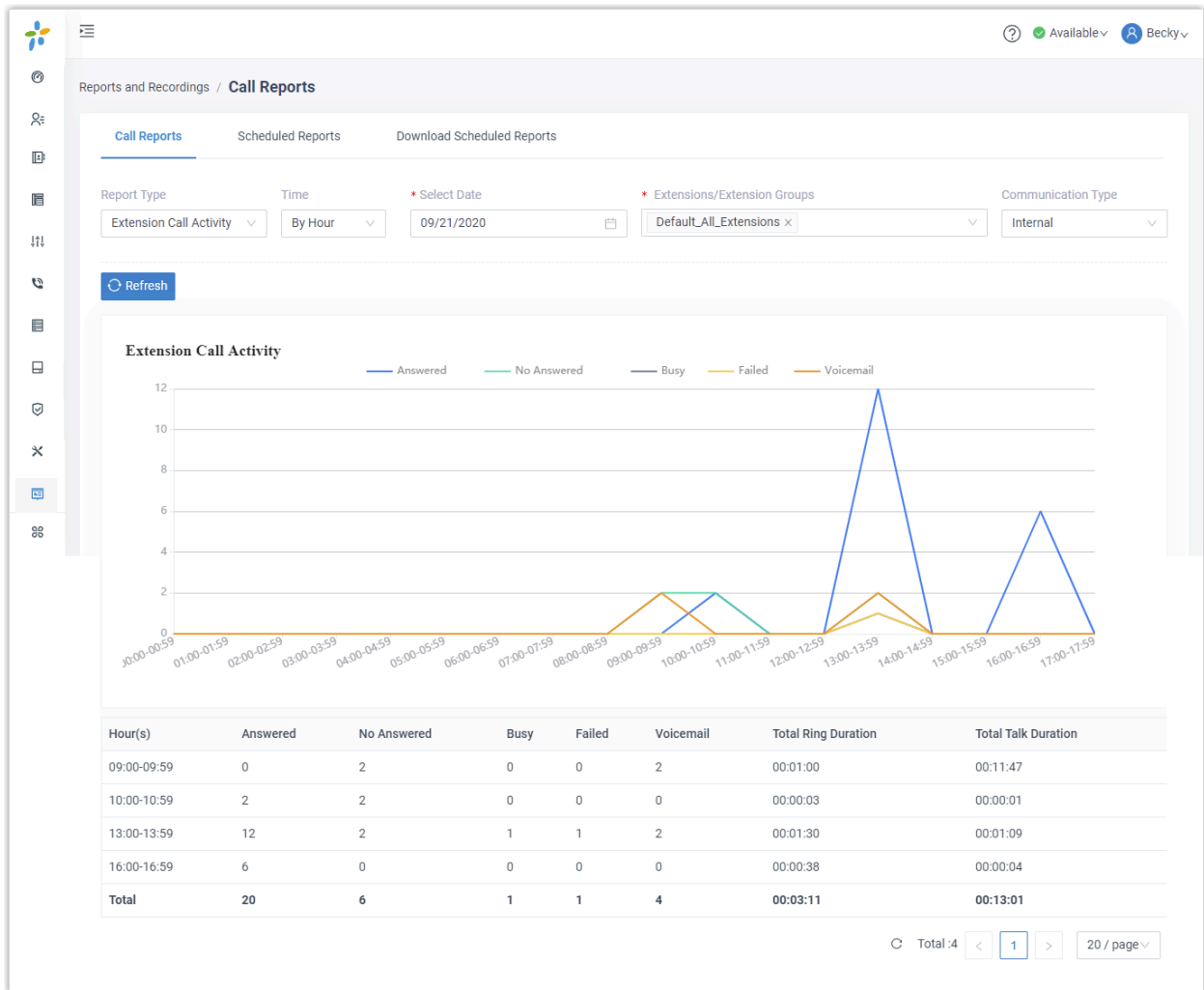

Trunk Activity Report

Trunk Activity Report is a summary report displayed in line graph, which makes it possible for you to query how many inbound and outbound calls have been received or made via a specific trunk. The report allows you to track changes of trunk activity by hour, by date, or by month.

Report example

The following report shows daily inbound & outbound call statistics of all the extensions in group **Default_All_Extensions** on September, 2020.

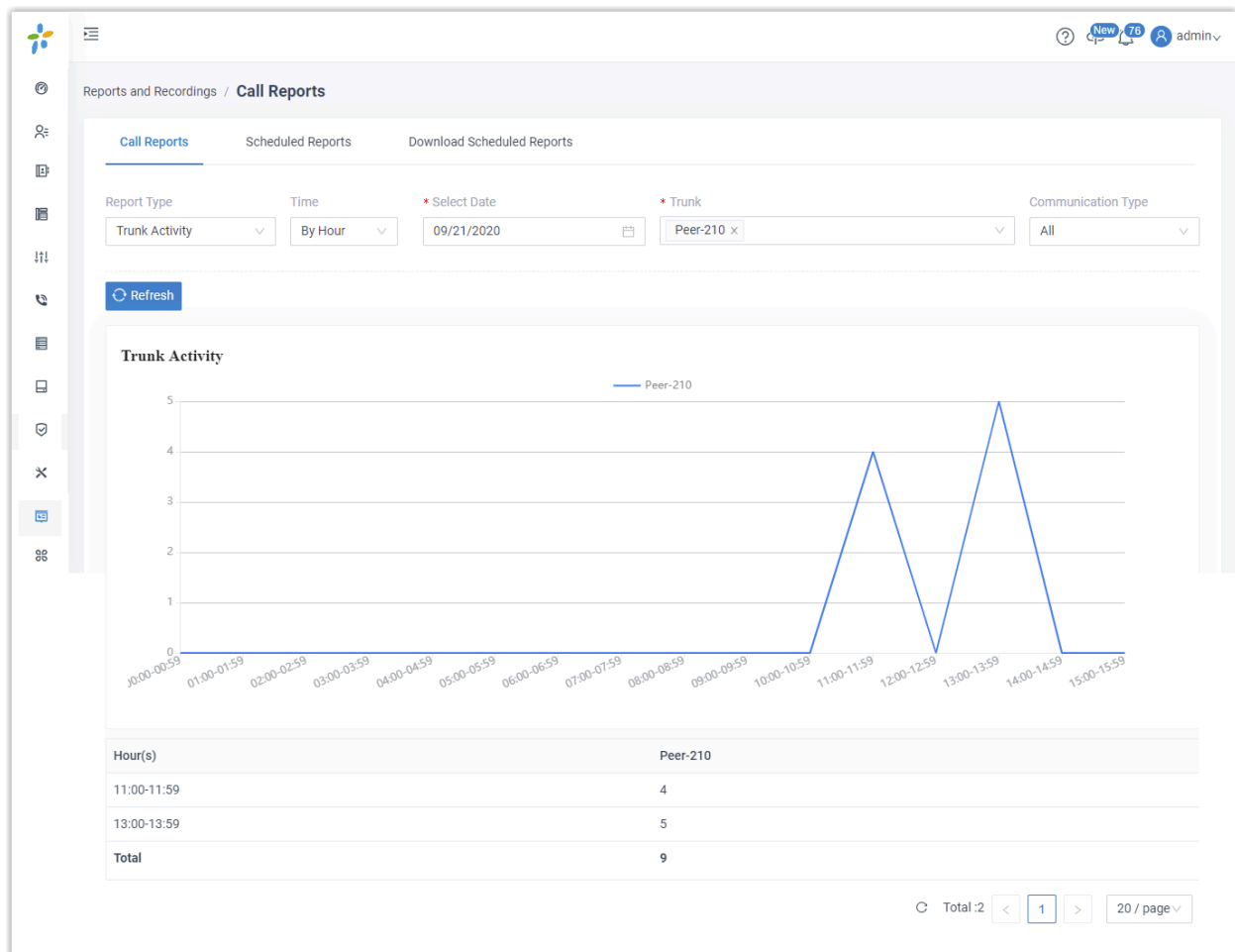

DID/Outbound Caller ID Activity Report

DID/Outbound Caller ID Activity Report is a summary report displayed in line graph, which allows you to track changes of DID/Outbound Caller ID activity by hour, by date, or by month.

Report example

The following report shows hourly call statistics of all the extensions in group **Default_All_Extensions** on September 21, 2020.

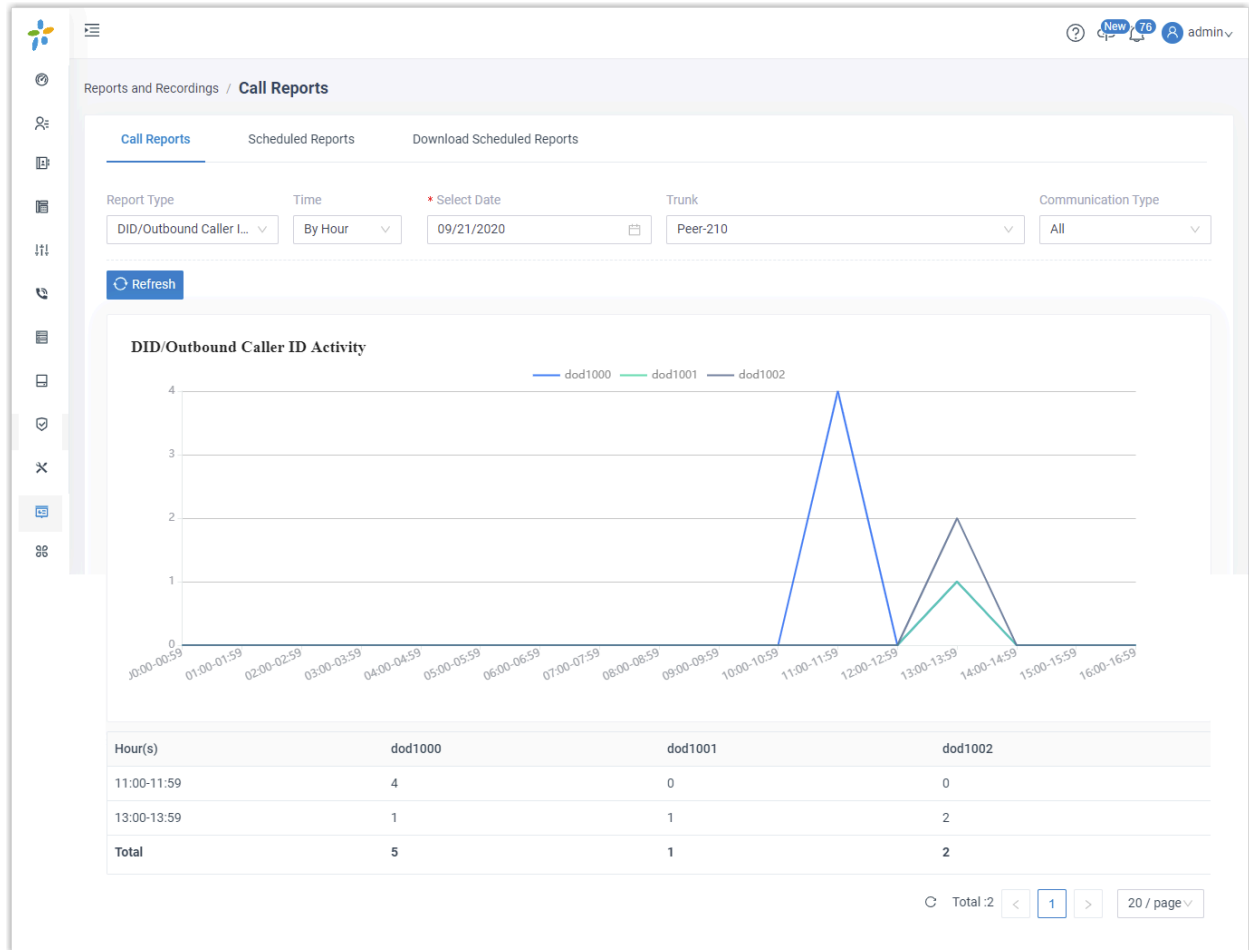

Ring Group Statistics Report

Ring Group Statistics Report is a summary report based on Yeastar Enterprise Plan or Ultimate Plan, which allows you to query the number of received and answered calls for a specific ring group, thus helping you evaluate performance of members within the ring group.

Prerequisites

Ring Group Statistics Report is only available for Yeastar P-Series Enterprise Plan and Ultimate Plan.

Report details

The following table lists the related parameters for Ring Group Statistics report.

Parameter	Description
Answered	The total number of calls that were answered.
Received	The total number of calls that were received.
Answered Rate	The answered rate for the ring group or for each group member.

Report example

The following report shows call statistics of ring group **6300** and **6301** during **09/21/2020 00:00:00-09/21/2020 23:59:59**.

Reports and Recordings / Call Reports

Call Reports | Scheduled Reports | Download Scheduled Reports

Report Type: Ring Group Statistics | Time: 09/21/2020 00:00:00 ~ 09/21/2020 23:59:59 | Ring Group: 6300 x 6301 x

Refresh

Ring Group	Answered	Received	Answered Rate
6300<6300>	4	5	80%
Becky<1000>	1		20%
Caroline<1001>	1		20%
Anderson<6666>	2		40%
6301<6301>	2	2	100%
Becky<1000>	1		50%
Anderson<6666>	1		50%
Total	6	7	86%

Total: 7 | 1 | 20 / page

Manage Call Reports

View Call Reports

This topic describes how to view call reports on Yeastar P-Series PBX System.

Procedure

1. Log in to the PBX web interface, go to **Reports and Recordings > Call Reports > Call Reports**.
2. Set search criteria.
 - a. In the **Report Type** drop-down list, select the desired report.
 - b. Set a time period that the report covers.

- c. Set one or more objects that you want to query.

Result

Relevant call statistics are displayed on the page.

Schedule Call Reports

This topic describes how to schedule a call report to be sent to a recipient's mailbox at the specified time.

Background information

A scheduled call report is a diagram containing call statistics for the selected objects within a specific time frame. It automatically runs at a pre-defined frequency and is emailed to a specific address as a link and can be downloaded in CSV, XLS, or PDF.

Prerequisites

Make sure [email server](#) works.

Procedure

1. Log in to the PBX web interface, go to **Reports and Recordings > Call Reports**, click **Scheduled Reports** tab.
2. Click **Add Reports**.
3. In the **Report Type** drop-down list, choose the desired report, and select one or more objects that you want to query.
4. Schedule the report.
 - **Time**: Set a time frame that the desired report covers.
 - **Report Name**: Enter a name to help you identify it.
 - **Email Address**: Enter a recipient's email address.

The report will be sent to the email address at the specified time.

- **Report Frequency**: Set how often to send the report.
 - # **Once**: If you choose the option, the system sends the report immediately after you save the setting.
 - # **Daily**: If you choose the option, select a time from the drop-down list. The system sends the report at this time of the day.
 - # **Weekly**: If you choose the option, choose a day of week and select a time from the drop-down list. The system sends the report at this time of the week.
 - # **Monthly**: If you choose the option, choose a day and select a time from the drop-down list. The system sends the report on this day and time of the month.

 **Note:** If you set the day to **31**, but the month only has 29 or 30 days, the system will not send the report.

- **Format:** Set in which format the report can be downloaded.

CSV

XLS

PDF

5. Click **Save**.

Result

On **Scheduled Reports** list, check status of the scheduled call report.

- **Finished:** The one-off call report was sent to the recipient's email address.
- **Scheduled:** The call report is scheduled and valid. The system will send the report to the recipient's email address at the specified time.
- **Paused:** The scheduled call report is on hold because the Call Center Service expired. To renew it, go to Yeastar P-Series Enterprise Plan or Ultimate Plan.

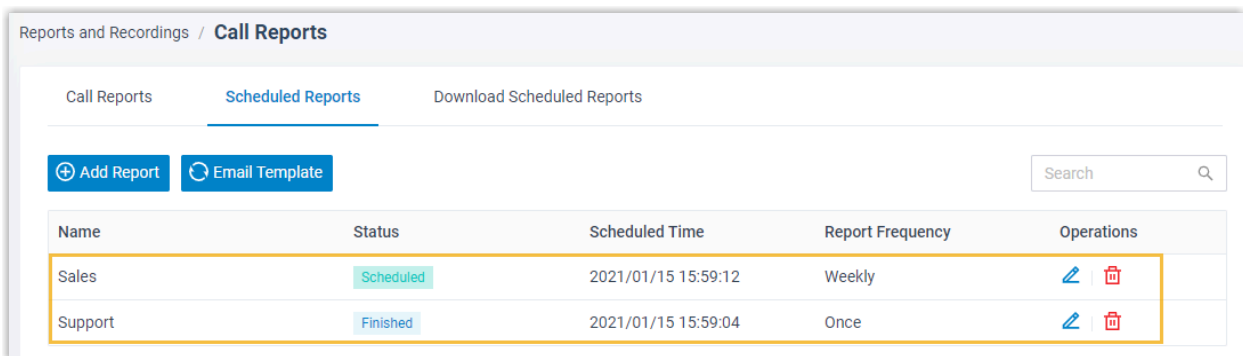

Reports and Recordings / Call Reports

Call Reports **Scheduled Reports** Download Scheduled Reports

[Add Report](#) [Email Template](#) Search

Name	Status	Scheduled Time	Report Frequency	Operations
Sales	Scheduled	2021/01/15 15:59:12	Weekly	Edit Delete
Support	Finished	2021/01/15 15:59:04	Once	Edit Delete

What to do next

To customize email template for call reports, see [Customize Email Template for Scheduled Reports](#).

Manage Scheduled Reports

This topic describes how to edit and delete scheduled reports.

Edit scheduled reports

1. Log in to the PBX web interface, go to **Reports and Recordings > Call Reports**, click **Scheduled Reports**.
2. Select the desired report, click .
3. Edit the scheduled report according to your needs.

4. Click **Save**.

Delete scheduled reports

1. Log in to the PBX web interface, go to **Reports and Recordings > Call Reports**, click **Scheduled Reports**.
2. Select the desired report, click .
3. In the pop-up dialog box, click **OK**.

Download Scheduled Reports on Web Interface

This topic describes how to download scheduled reports on the PBX's web interface.

Prerequisites

A scheduled report was sent out.

Procedure

1. Log in to the PBX web interface, go to **Reports and Recordings > Call Reports**, click **Download Scheduled Reports** tab.
2. Select the desired call report, click .
- The report contains a snapshot of data for the time frame you have selected.
3. At the top-right corner, click **Download**.

Result

The report is downloaded to your computer in the pre-defined format.

Customize Email Template for Scheduled Reports

This topic describes how to customize email template for scheduled reports.

Background information

By default, Yeastar P-Series PBX System sends scheduled call reports in the language that you have set in [system email template](#). A report email contains the following information:

- A download link for call report.
- Soft reminder of the download link.
 - # The link is valid for 24 hours.
 - # The link can only be accessed over the same local network as the PBX.
- System information, including PBX name, PBX serial number, PBX LAN IP address, and PBX WAN IP address.

Procedure

1. Log in to the PBX web interface, go to **Reports and Recordings > Call Reports > Scheduled Reports**.
2. Click **Email Template**.
3. Configure template settings.
 - a. In the **Template** drop-down list, select **Custom**.
 - b. Edit email subject and content according to your needs.
 - c. Click **Save**.

Result

The PBX will use the email template to send scheduled reports.

Refereneces

Import and Export Parameters Overview

Check the required parameters, optional parameters, and restrictions in the import and export files.

Background information

CSV (comma-separated values) files can expedite the bulk creation of various settings. A CSV file is a plain text file that stores tabular data from database-style tools, such as Excel.

Yeastar P-Series PBX System allows you to export data as a CSV file, specify data in the CSV file, and import the file to PBX to modify settings in bulk, such as creating extensions in bulk using CSV file.

Which features support importing and exporting data

Yeastar P-Series PBX System supports importing and exporting data of the following modules:

- [Extension Parameters](#)
- [Contacts Parameters](#)
- [Trunk Parameters](#)
- [Inbound Route Parameters](#)
- [Outbound Route Parameters](#)





 **Note:** The supported parameters are different depending on firmware version.



Extension Parameters







Descriptions for parameters in exported and imported Extension CSV file.





Parameter	Description	Importance	Restriction	Default Value
First Name	The first name of extension user.	At least one is required	The maximum character length is 63.	Extension number
Last name	The last name of extension user.		 Note: First Name will be filled with a value of <i>Extension Number</i> if you leave these fields empty.	N/A
Email Address	The email address of extension user.	Optional	Only numbers, letters, and characters @ _ - . are allowed. Must start with a number, letter or	N/A



Parameter	Description	Importance	Restriction	Default Value
			character <code>_</code> and follow the email address format <code>XXX@XXX.XX</code> . Extension's email address cannot be duplicated. The maximum character length is 255.	
Mobile Number	The mobile number of extension user.	Optional	Numbers, letters, and characters () <code>. - + * #</code> are allowed. The maximum character length is 31.	N/A
User Password	The password for extension user to log in to Linkus client.	Required	Must contain numbers, uppercase, and lowercase letters. The minimum character length is 10 and the maximum is 63. Note: User Password will be generated randomly if you leave this field empty.	Generate Randomly
User Role	The role for extension user with PBX management permission.	Required	Permitted value: <code>0</code> or one of the role names defined in the PBX. <code>0</code> means [None]. Note: User Role will be filled with default value <code>0</code> if you leave this field empty.	0
Extension Number	The extension's number.	Required	Extension Number cannot be duplicated, and only numbers are allowed. The maximum character length is 7.	N/A
Caller ID	The caller ID that is displayed on the callee's device.	Required	Numbers, letters, and special characters () <code>. - + * #</code> are allowed. The maximum character length is 31. Note: Caller ID will be filled with default value <i>Extension Number</i> if you leave this field empty.	Extension Number
Registration Name	The registration name that is used to validate extension registration.	Required	The maximum character length is 63. Note: Registration Name will be generated randomly if you leave this field empty.	Generate Randomly
Registration Password	The password for the user to register the SIP extension.	Required	The minimum character length is 8 and the maximum is 63. Note: Registration Password will be generated randomly if you leave this field empty.	Generate Randomly

Parameter	Description	Importance	Restriction	Default Value
Emergency Outbound Caller ID	The outbound Caller ID for the extension when it makes emergency calls.	Optional	Numbers, letters, and characters () . - + * # are allowed. The maximum character length is 31.	N/A
Enable Voicemail	Whether to enable or disable voicemail feature.	Required	Permitted value: <ul style="list-style-type: none"> • 0: Disable • 1: Enable  Note: Enable Voicemail will be filled with default value if you leave this field empty.	1
Voicemail PIN Authentication	Whether to enable or disable voicemail PIN authentication.	Required if Enable Voicemail = 1	Permitted value: <ul style="list-style-type: none"> • 0: Disable • 1: Enable  Note: Voicemail PIN Authentication will be filled with default value if you leave this field empty.	1
Voicemail Access PIN	The PIN for authentication when accessing voicemail box.	Required if Enable Voicemail = 1 & Voicemail PIN Authentication = 1	Only numbers are allowed. The minimum character length is 3 and the maximum is 15.  Note: Voicemail Access PIN will be generated randomly if you leave this field empty.	Generate Randomly
New Voicemail Notification	The notification type for new voicemail	Required if Enable Voicemail = 1	Permitted value: <ul style="list-style-type: none"> • no: No Email Notifications • with_attach: Send Email Notifications with Attachment • without_attach: Send Email Notifications without Attachment  Note: New Voicemail Notification will be filled with default value if you leave this field or Email Address empty.	no
After Notification	The way to handle voicemail message in mailbox after	Required if Enable Voicemail = 1 & New	Permitted value: <ul style="list-style-type: none"> • no: Do Nothing • mark_read: Mark as read 	no

Parameter	Description	Importance	Restriction	Default Value
	receiving the message notification via email.	Voicemail Notification = with_attach	<ul style="list-style-type: none"> • <i>delete</i>: Delete Voicemail <p> Note: After Notification will be filled with default value <i>no</i> if you leave these fields empty.</p>	
		Required if Enable Voicemail = 1 & New Voicemail Notification = without_attach	Permitted value: <ul style="list-style-type: none"> • <i>no</i>: Do Nothing • <i>mark_read</i>: Mark as read <p> Note: After Notification will be filled with default value <i>no</i> if you leave these fields empty.</p>	no
Play Date and Time	Whether to announce arrival time of the message before playing the voicemail message.	Required if Enable Voicemail = 1	Permitted value: <ul style="list-style-type: none"> • <i>0</i>: Disable • <i>1</i>: Enable <p> Note: Play Date and Time will be filled with default value if you leave this field empty.</p>	0
Play Caller ID	Whether to announce caller ID of the party that left the message before playing the voicemail message.	Required if Enable Voicemail = 1	Permitted value: <ul style="list-style-type: none"> • <i>0</i>: Disable • <i>1</i>: Enable <p> Note: Play Caller ID will be filled with default value if you leave this field empty.</p>	0
Play Message Duration	The duration of the message (in minutes) will be announced before playing the voicemail message.	Required if Enable Voicemail = 1	Permitted value: <ul style="list-style-type: none"> • <i>0</i>: Disable • <i>1</i>: Enable <p> Note: Play Message Duration will be filled with default value if you leave this field empty.</p>	0
Send email notification when the User Password is changed	Whether to send email notification when the User Password is changed.	Required	Permitted value: <ul style="list-style-type: none"> • <i>0</i>: Disable • <i>1</i>: Enable <p> Note: Send email notification when the User Password is changed</p>	1

Parameter	Description	Importance	Restriction	Default Value
			will be filled with default value if you leave this field empty.	
Send email notifications on missed calls	Whether to send email notifications on missed calls.	Required	Permitted value: <ul style="list-style-type: none"> • 0: Disable • 1: Enable  Note: Send email notifications on missed calls will be filled with default value if you leave this field empty.	0
Allow users to start and stop recording	Whether to allow users to start and stop recording.	Required	Permitted value: <ul style="list-style-type: none"> • 0: Disable • 1: Enable  Note: Allow users to start and stop recording will be filled with default value if you leave this field empty.	1
DTMF Mode	The mode for sending DTMF tones.	Required	Permitted value: <i>rfc4733</i> , <i>info</i> , <i>inband</i> or <i>auto</i> .  Note: DTMF Mode will be filled with default value <i>rfc4733</i> if you leave these fields empty.	rfc4733
Transport	The protocol for transport	Required	Permitted value: <i>udp</i> , <i>tcp</i> or <i>tls</i> .  Note: Transport will be filled with default value <i>udp</i> if you leave these fields empty.	udp
Qualify	Whether to send the SIP OPTIONS packet periodically to the SIP device to check if the device is online.	Required	Permitted value: <ul style="list-style-type: none"> • 0: Disable • 1: Enable  Note: Qualify will be filled with default value if you leave this field empty.	1
T.38 Support	Whether to support T.38 fax for this extension.	Required	Permitted value: <ul style="list-style-type: none"> • 0: Disable • 1: Enable  Note: T.38 Support will be filled with default value if you leave this field empty.	0

Parameter	Description	Importance	Restriction	Default Value
SRTP	Whether to encrypt RTP packets.	Required	Permitted value: <ul style="list-style-type: none"> • 0: Disable • 1: Enable  Note: SRTP will be filled with default value if you leave this field empty.	0
Allow Remote Registration	Whether to allow user to register a remote SIP extension to PBX.	Required	Permitted value: <ul style="list-style-type: none"> • 0: Disable • 1: Enable  Note: Allow Remote Registration will be filled with default value if you leave this field empty.	0
Disable Outbound Calls	Whether to restrict the user from making outbound calls.	Required	Permitted value: <ul style="list-style-type: none"> • 0: Disable • 1: Enable  Note: Disable Outbound Calls will be filled with default value if you leave this field empty.	0
Disable Outbound Calls outside Business Hours	Whether to restrict the user from making outbound calls outside business hours.	Required	Permitted value: <ul style="list-style-type: none"> • 0: Disable • 1: Enable  Note: Disable Outbound Calls outside Business Hours will be filled with default value if you leave this field empty.	0
Max Outbound Call Duration (s)	The maximum call duration in seconds for making outbound calls from this extension.	Required	Only numbers are allowed. Specially, -1 means follow system and 0 means unlimited. The maximum character length is 7.  Note: Max Outbound Call Duration (s) will be filled with default value <i>follow_system</i> if you leave these fields empty.	-1
Linkus Mobile Client	Whether to allow the extension user to log in to	Required	Permitted value: <ul style="list-style-type: none"> • 0: Disable • 1: Enable 	1

Parameter	Description	Importance	Restriction	Default Value
	Linkus Mobile Client.		 Note: Linkus Mobile Client will be filled with default value if you leave this field empty.	
Linkus Desktop Client	Whether to allow the extension user to log in to Linkus Desktop Client.	Required	Permitted value: <ul style="list-style-type: none"> • 0: Disable • 1: Enable  Note: Linkus Desktop Client will be filled with default value if you leave this field empty.	1
Linkus Web Client	Whether to allow the extension user to log in to Linkus Web Client.	Required	Permitted value: <ul style="list-style-type: none"> • 0: Disable • 1: Enable  Note: Linkus Web Client will be filled with default value if you leave this field empty.	1

Related information

[Export and Import SIP Extensions](#)

Contacts Parameters

Descriptions for parameters in exported and imported company and personal contacts CSV file.

Parameter	Importance	Restriction
First Name	At least one is required	The maximum character length is 127 (63 for first name and 63 for last name).
Last Name		
Company Name	Optional	The maximum character length is 127.
Email	Optional	Only numbers, letters, and characters @ _ - . are allowed. Must start with a number, letter or character _ and follow the email address format XXX@XXX.XX. The maximum character length is 255.
Business Number	At least one is required	Numbers, letters, and characters () . - + * # are allowed. The maximum character length is 31.
Business Number 2		Numbers, letters, and characters () . - + * # are allowed. The maximum character length is 31.

Parameter	Importance	Restriction
Business Fax		Numbers, letters, and characters () . - + * # are allowed. The maximum character length is 31.
Mobile		Numbers, letters, and characters () . - + * # are allowed. The maximum character length is 31.
Mobile 2		Numbers, letters, and characters () . - + * # are allowed. The maximum character length is 31.
Home		Numbers, letters, and characters () . - + * # are allowed. The maximum character length is 31.
Home 2		Numbers, letters, and characters () . - + * # are allowed. The maximum character length is 31.
Home Fax		Numbers, letters, and characters () . - + * # are allowed. The maximum character length is 31.
Other		Numbers, letters, and characters () . - + * # are allowed. The maximum character length is 31.
ZIP Code	Optional	The maximum character length is 255.
Street	Optional	The maximum character length is 255.
City	Optional	The maximum character length is 255.
State	Optional	The maximum character length is 255.
Country	Optional	The maximum character length is 255.

Related information





[Export and Import Company Contacts](#)









Trunk Parameters

Descriptions for parameters in exported and imported Trunk CSV file.

 **Note:** Only Peer Trunk and Register Trunks can be imported.

Parameter	Description	Importance	Restriction
Name	The trunk name.	Required	The maximum character length is 255. Space and special characters are not allowed. Trunk's name cannot be duplicated.
Trunk Status	Whether to enable or disable the trunk.	Required	Permitted value: <ul style="list-style-type: none"> 0: Disable

Parameter	Description	Importance	
			<ul style="list-style-type: none"> • 1: Enable  Note: Trunk Status will be filled with 1 if the field is empty.
Trunk Type	Trunk type.	Required	Permitted value: <i>peer</i> or <i>register</i>  Note: <ul style="list-style-type: none"> • Importing Account Trunk is • Trunk Type will be filled with 1
Transport	The transport protocol that is provided by the ITSP.	Required	Permitted value: <i>udp</i> , <i>tcp</i> , <i>tls</i> , or  Note: Transport will be filled with 1 if the field is empty.
Hostname/IP	The IP address or the domain of the ITSP.	Required	The maximum character length is 64.
Port	The trunk port.	Required	Only numbers between 0 and 65535.
Domain	The IP address or the domain of the ITSP.	Required	The maximum character length is 64.
Username	The username to register to the ITSP.	Required if Trunk Type = register	The maximum character length is 64.
Password	The password that is associated with the username.	Required if Trunk Type = register	The maximum character length is 64.
Authentication Name	The authentication name to register to the ITSP.	Optional	The maximum character length is 64.
Enable Outbound Proxy	Whether to enable or disable outbound proxy.	Required if Trunk Type = register	Permitted value: <ul style="list-style-type: none"> • 0: Disable • 1: Enable  Note: Enable Outbound Proxy will be filled with 1 if the field is empty, otherwise leave this field empty.
Outbound Proxy Server	The address of outbound proxy server.	Required if Enable Outbound Proxy = 1	The maximum character length is 64.
Port of Outbound Proxy Server	The port of outbound proxy server.	Required if Enable Outbound Proxy = 1	Only numbers between 1 and 65535.
Codec Setting	The audio codec for trunk.	Required	Permitted value: <i>ulaw</i> , <i>alaw</i> , <i>g722</i> , <i>g726</i> , <i>speex</i> , <i>adpcm</i> , <i>vp8</i> , or <i>mpeg4</i> For multiple Codec, please enter the value separated by &, e.g. first_value1&second_value2.  Note: If the value you enter is not supported, it will be skipped.

Parameter	Description	Importance	
DTMF Mode	The default mode for sending DTMF tones.	Required	Permitted value: <i>rfc4733</i> , <i>info</i> ,  Note: DTMF Mode will be fill these fields empty.
Qualify	Whether to send SIP OPTION packet to check if the SIP device is up.	Required	Permitted value: <ul style="list-style-type: none">• <i>0</i>: Disable• <i>1</i>: Enable  Note: Qualify will be filled wi
Enable SRTP	Whether to enable or disable SRTP (encrypted RTP) for the trunk.	Required	Permitted value: <ul style="list-style-type: none">• <i>0</i>: Disable• <i>1</i>: Enable  Note: Enable SRTP will be f empty.
T.38 Support	Whether to enable or disable T.38 fax.	Required	Permitted value: <ul style="list-style-type: none">• <i>0</i>: Disable• <i>1</i>: Enable  Note: T.38 Support will be fil empty.
Inband Progress	Whether to enable or disable inband progress.	Required	Permitted value: <ul style="list-style-type: none">• <i>0</i>: Disable• <i>1</i>: Enable  Note: Inband Progress will b field empty.
Maximum Concurrent Calls	Specify the maximum number of concurrent calls allowed in the trunk.	Required	Only numbers are allowed. Specially, 0 means unlimited. The maximum character length is  Note: Maximum Concurrent leave this field empty.
Call Restriction Type	Specify based on which type of calls to define to restrict the max concurrent call number for this trunk.	Required	Permitted value: <i>outbound</i> or <i>all</i>  Note: Call Restriction Type v this field empty.
Default Outbound Caller ID	The caller ID that is displayed on the callee's device.	Optional	Numbers, letters, and characters The maximum character length is  Note: The outbound caller ID

Parameter	Description	Importance	
Default Outbound Caller ID Name	The caller ID name that is displayed on the callee's device.	Optional	The maximum character length is

Related information



[Export and Import SIP Trunks](#)



Inbound Route Parameters

Descriptions for parameters in imported and exported Inbound Route CSV file.

Parameter	Description	Importance	Restriction	Default Value
Name	The name of inbound route.	Required	Space and special characters are not allowed. Inbound route's name cannot be duplicated. The maximum character length is 63.	N/A
DID Matching Mode	The DID matching mode.	Optional	Permitted value: <ul style="list-style-type: none"> <code>patterns</code>: DID Patterns <code>pattern_to_ext</code>: DID Pattern to Extensions <code>range_to_ext</code>: DID Range to Extension Range <p> Note: DID Matching Mode will be filled with default value patterns if you leave these fields empty.</p>	patterns
DID Pattern	The DID pattern that is used to match callee number. Only when the callee number is matched will the inbound call go through this route.	Required if DID Matching Mode # patterns	<ul style="list-style-type: none"> If DID Matching Mode = <code>patterns</code>, you can enter one or more patterns. Numbers, letters <code>X Z N</code> and characters <code>[] * # () . - + !</code> are allowed. The maximum character length is 31 (for each DID). Please use <code>&</code> as a separator for multiple patterns, e.g. <code>pattern1&pattern2</code>. If DID Matching Mode = <code>pattern_to_ext</code>, only numbers, letters <code>X Z N</code>, characters <code>[] * # () - +</code>, 	N/A

Parameter	Description	Importance	Restriction	Default Value
			<p>and placeholder <code>{{.Ext}}</code> are allowed. The maximum character length is 31.</p> <p>The Default Destination must be <code>pattern_to_ext</code>, then fill multiple extension numbers with separator <code>&</code> in Number.</p> <ul style="list-style-type: none"> • If DID Matching Mode = <code>range_to_ext</code>, only numbers and character <code>+</code> (before numbers) are allowed. The maximum character length is 16 (for each DID). Please enter the start DID and the end DID with separator <code>-</code>, e.g. 5503301-5503305. <p>The Default Destination must be <code>range_to_ext</code>, then fill the start number and the end number with separator <code>-</code> in Number, e.g. 1001-1005.</p>	
Caller ID Pattern	The pattern used to match caller ID. Only when the caller ID matches the pattern can user dial in through this route.	Optional	<p>Numbers, letters <code>x z N</code>, characters <code>[] * # () . - + !</code> and placeholder <code>{{.Ext}}</code> are allowed. For multiple patterns, please enter patterns and use <code>&</code> as a separator, e.g. <code>pattern1&pattern2</code>.</p> <p>The maximum character length is 31 (for each pattern).</p>	N/A
Trunks	The trunks that incoming calls will be routed by this inbound route. The PBX will route inbound calls through this route when external users call the selected trunk number.	Required	<p>Permitted value: one or more trunk names existed in PBX. For multiple trunks, please enter trunk names and use <code>&</code> as a separator, e.g. <code>name1&name2</code>.</p> <p> Note: If the trunks you enter is not existing in PBX, Trunks will be skipped.</p>	N/A
Default Destination	The default destination to receive inbound calls.	Required	<p>Permitted value:</p> <ul style="list-style-type: none"> • <code>end_call</code>: Hang Up • <code>extension</code>: Extension • <code>range_to_ext</code>: Match extension Range (DID) 	<code>end_call</code>

Parameter	Description	Importance	Restriction	Default Value
			<p>Matching Mode = range_to_ext)</p> <ul style="list-style-type: none"> • pattern_to_ext: Match selected Extension (DID Matching Mode = pattern_to_ext) • ext_vm: Extension Voicemail • ivr: IVR • ring_group: Ring Group • queue: Queue • conference: Conference • fax_to_email: Fax to Email <p> Note: Default Destination will be filled with default value end_call if you leave these fields empty.</p>	
Number of Default Destination	The destination number to receive inbound calls.	Required if Default Destination # end_call	<p>Permitted value:</p> <ul style="list-style-type: none"> • If Default Destination = Extension, Extension Email, Group Voicemail, IVR, Ring Group, Queue, Conference, Or Fax to Email, please fill in a number. • If Default Destination = Match extension Range, please fill in a range of extension, e.g. 1000-1010. The maximum number length is 7 (for each number). • If Default Destination = Match selected Extension, please fill in numbers or names and use & as a separator, e.g. extension_number1&extension_number2&extension_group_name3. <p> Note: If the numbers or names you enter is not existing in PBX, Number of Default Destination will be skipped.</p>	N/A
Enable Fax Detection	Whether to enable or disable FAX detection.	Required	<p>Permitted value:</p> <ul style="list-style-type: none"> • 0: Disable • 1: Enable 	0

Parameter	Description	Importance	Restriction	Default Value
			 Note: Enable Fax Detection will be filled with default value if you leave this field empty.	
Fax Destination	The destination to receive fax.	Required if Enable Fax Detection = 1	Permitted value: <ul style="list-style-type: none"> • <code>end_call</code>: Hang Up • <code>extension</code>: Extension • <code>fax_to_email</code>: Fax to Email  Note: Fax Destination will be filled with default value <i>extension</i> if you leave these fields empty.	extension
Number of Fax Destination	The destination number to receive fax.	Required if Fax Destination # <code>end_call</code>	Permitted value: extension numbers existed in PBX. <ul style="list-style-type: none"> • If Fax Destination = <code>Extension</code>, fax will be send to extension number. • If Fax Destination = <code>Fax to Email</code>, fax will be send to extension's email address. 	N/A





Related information



[Export and Import Inbound Routes](#)

Outbound Route Parameters

Descriptions for parameters in exported and imported Outbound Route CSV file.

Parameter	Description	Importance	Restriction	Default Value
Name	The name of outbound route.	Required	Space and special characters are not allowed. Outbound route's name cannot be duplicated. The maximum character length is 63.	N/A
Outbound Caller ID	The caller ID that is displayed on the callee's device.	Optional	Numbers, letters, and characters () . - + * # are allowed. The maximum character length is 31.	patterns

Parameter	Description	Importance	Restriction	Default Value
Role	The role of an extension that is allowed to use the route to make outbound calls.	Optional	Permitted value: one or more role names existed in PBX. For multiple roles, please enter role names and use & as a separator, e.g. name1&name2.  Note: If the roles you enter is not existing in PBX, Role will be skipped.	N/A
Pattern	The pattern used to match a callee number. Only when the callee number is matched will the outbound call go through this route.	Required	Numbers, letters <i>x z N</i> and characters <i>[] * # () . - + !</i> are allowed. The maximum character length is 31.  Note: Pattern will be filled with default value <i>x</i> if you leave these fields empty.	N/A
Strip	The number of digits that will be stripped from the front of callee number before the call is placed.	Optional	Only numbers 1 - 16 are allowed.	N/A
Prepend	The digits that will be prepended to the callee number before the call is placed.	Optional	Numbers, letters, and characters <i>() . - + * #</i> are allowed. The maximum character length is 31.	N/A
Trunks	The trunks that can be used to dial out. The PBX will route outbound calls through this trunk when the dialed number matches the outbound route.	Required	Permitted value: one or more trunk names existed in PBX. For multiple trunks, please enter trunk names and use & as a separator, e.g. name1&name2.  Note: If the trunk you enter does not exist in PBX, it will be skipped.	N/A
Rmemory Hunt	Whether to remember which trunk was used last time, and then use the next available trunk to call out.	Required	Permitted value: <ul style="list-style-type: none"> • <i>0</i>: Disable • <i>1</i>: Enable  Note: Rmemory Hunt will be filled with default value <i>0</i> if you leave this field empty.	0
Extensions	The extensions that are allowed to make	Optional	Permitted value: one or more extension numbers and	extension

Parameter	Description	Importance	Restriction	Default Value
	outbound calls through this route.		<p>extension group names existed in PBX.</p> <p>For multiple extensions or extension groups, please enter the numbers or names and use <i>&</i> as a separator, e.g. extension_number1&extension_number2&extension_group_name3.</p> <p> Note: If the extensions or group names you enter is not existing in PBX, Extensions will be skipped.</p>	
Outbound Route Password	Whether to require users to enter the same PIN to make outbound calls through this route.	Required	<p>Permitted value: disable, single_pin or pin_list.</p> <p> Note: Outbound Route Password will be filled with default value <i>disable</i> if you leave these fields empty.</p>	N/A
PIN	The PIN is required to make outbound calls through this route.	Required if Outbound Route Password = single_pin	<p>Only numbers are allowed.</p> <p>The minimum character length is 3 and the maximum is 15.</p>	N/A

Related information

[Export and Import Outbound Routes](#)