

ZONE WIRELESS | PLUS REPLACEABLE EARPAD COVERS

Complete Setup Guide

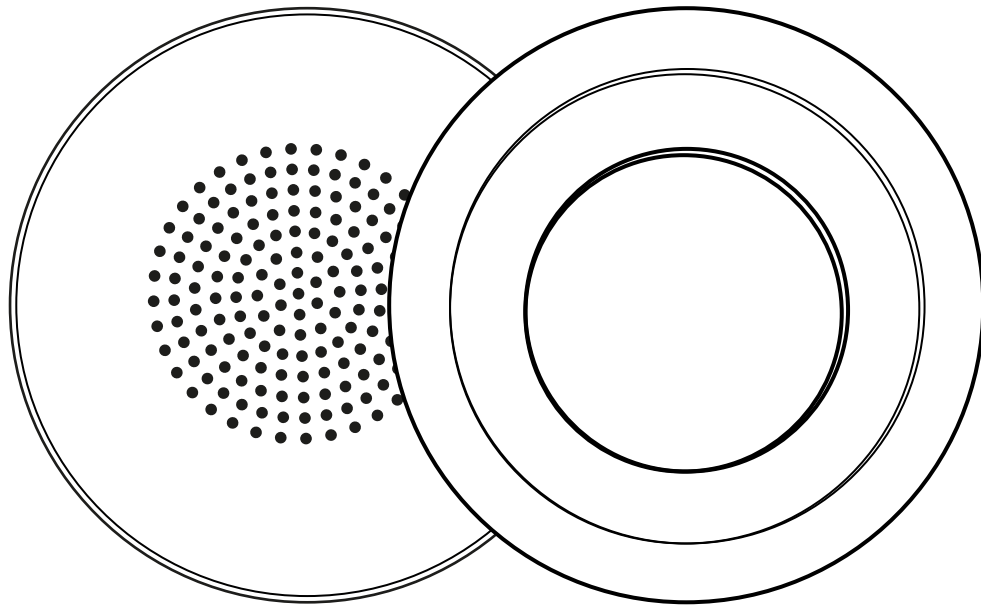

CONTENTS

English	3	Česká verze.	63
Deutsch	7	Slovenčina	67
Français	11	Українська.	71
Italiano	15	Eesti	75
Español	19	Latviski	79
Português	23	Lietuvių	83
Nederlands	27	Български	87
Svenska.	31	Hrvatski	91
Dansk.	35	Srpski	95
Norsk	39	Slovenščina	99
Suomi.	43	Română	103
Ελληνικά.	47	Türkçe	107
По-руски	51	111 العربية	
Po polsku	55	115 עברית	
Magyar	59		

KNOW YOUR PRODUCT

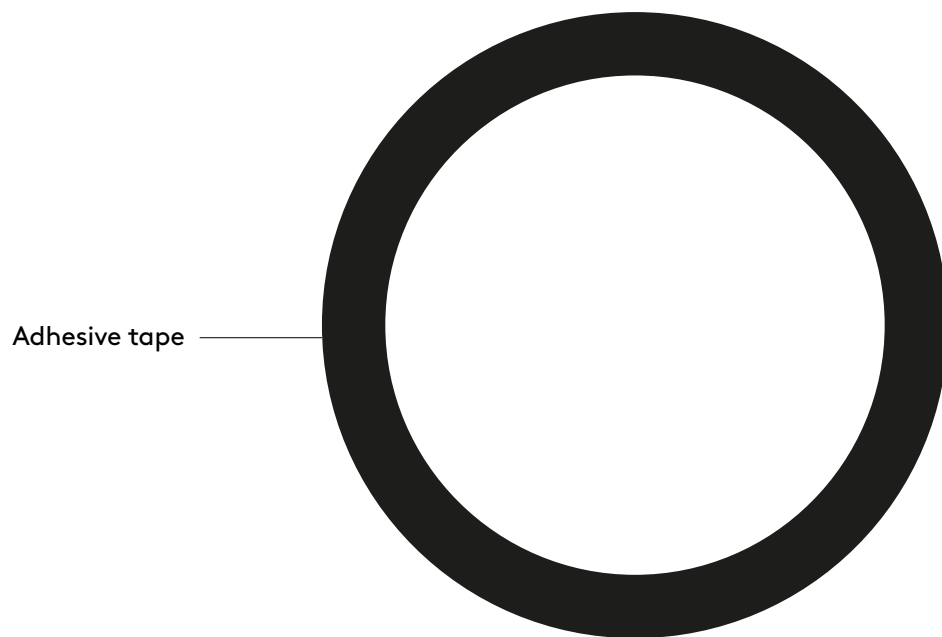
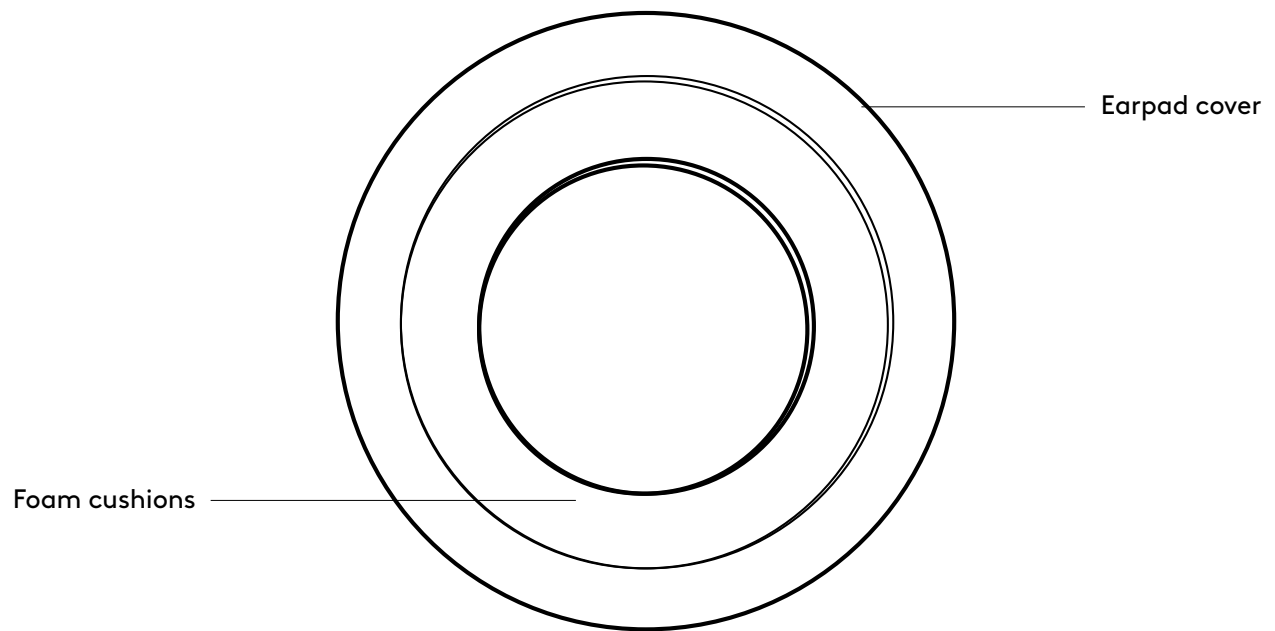

WHAT'S IN THE BOX

1. 1 pair (2 pcs) of replaceable earpad covers
2. 1 pair (2 pcs) of foam cushions
3. 1 pair (2 pcs) of adhesive tapes

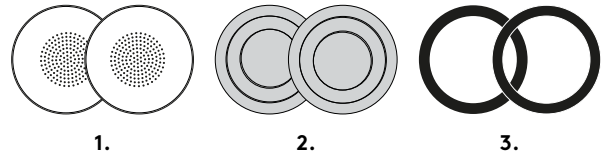

REPLACING EARPAD COVERS

1. Take the existing earpad cover off by carefully pinching the cover.

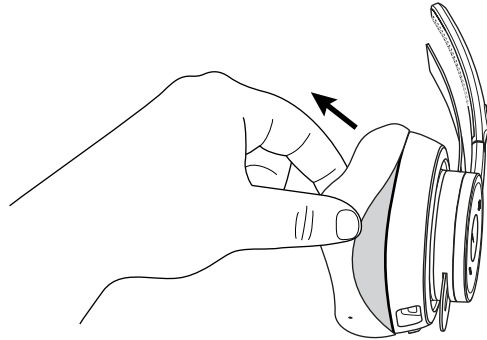

2. Remove the earpad cover slowly until it is completely off.

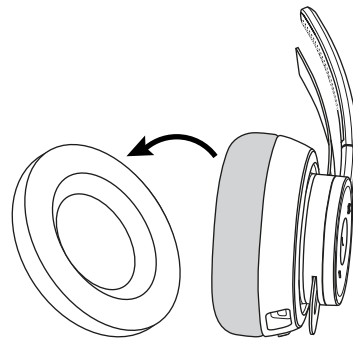

Make sure not to pinch the foam cushion which can be damaged easily.

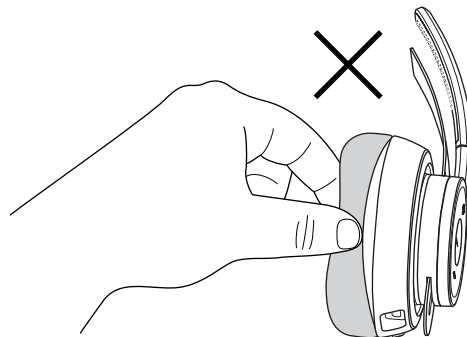

3. If foam cushion is damaged, please follow the steps below.
 - a. Peel the foam cushion off and replace with a new one.

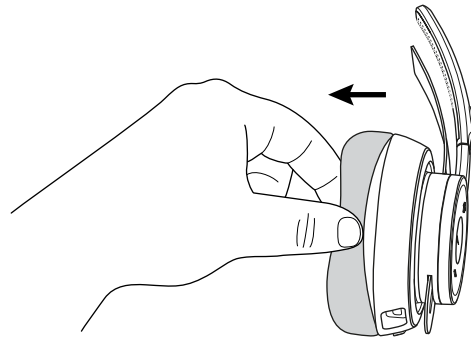

- b. Place the tape on the top of the ear cup first.

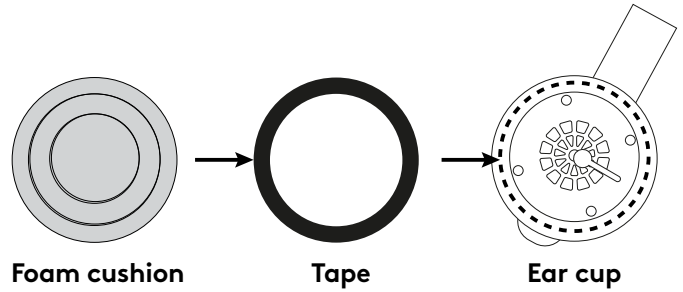

- c. Then attach the foam cushion to the tape.

4. Grasp the new earpad cover, making sure that the small holes on the side align with the top and bottom of the ear cup. It should align with the USB C port at the bottom.

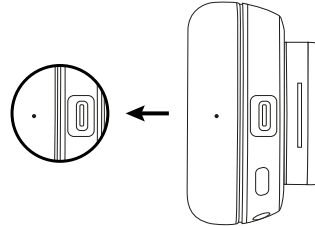

5. Starting from the top, slot the edge of the earpad cover inside the gap. Put the edge of the cover into the gap around the earcan.

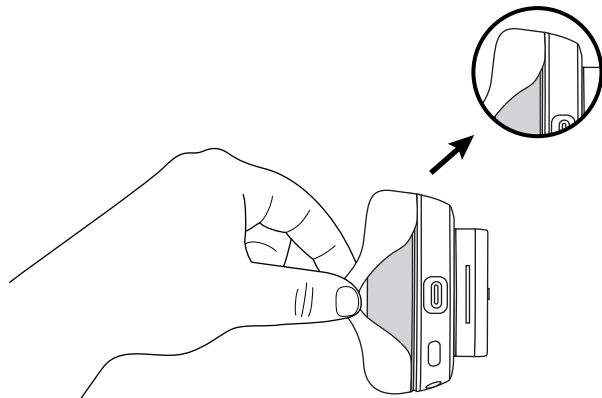

6. After completing, gently pat the earcup several times to push the air out.

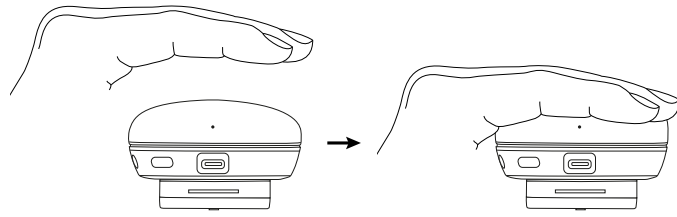

DIMENSIONS

EARPAD COVERS:

Height x Width x Depth: 70.7 mm x 70.7 mm x 16.4mm

www.logitech.com/support/zone-wireless-earpad-covers

PRODUKT AUF EINEN BLICK

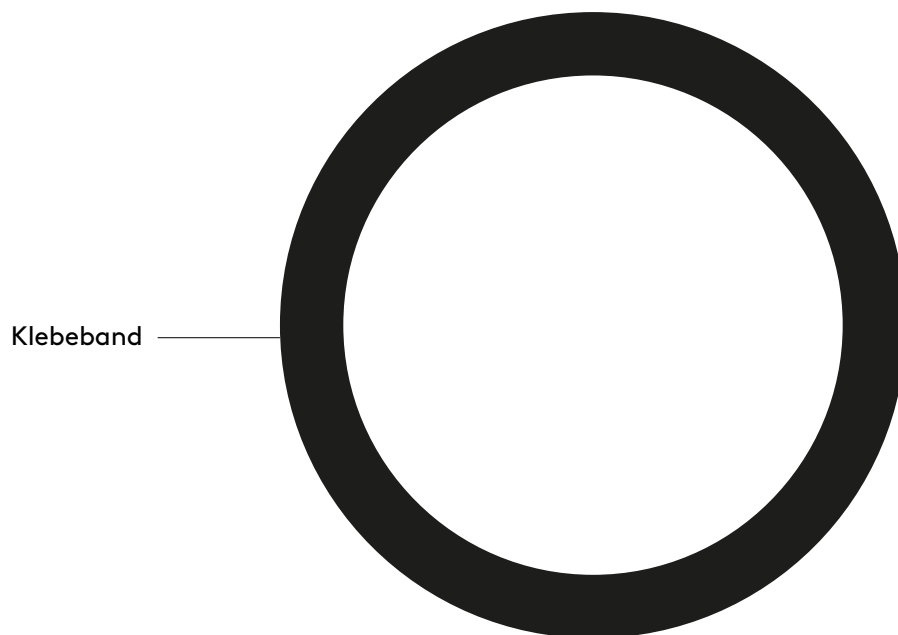
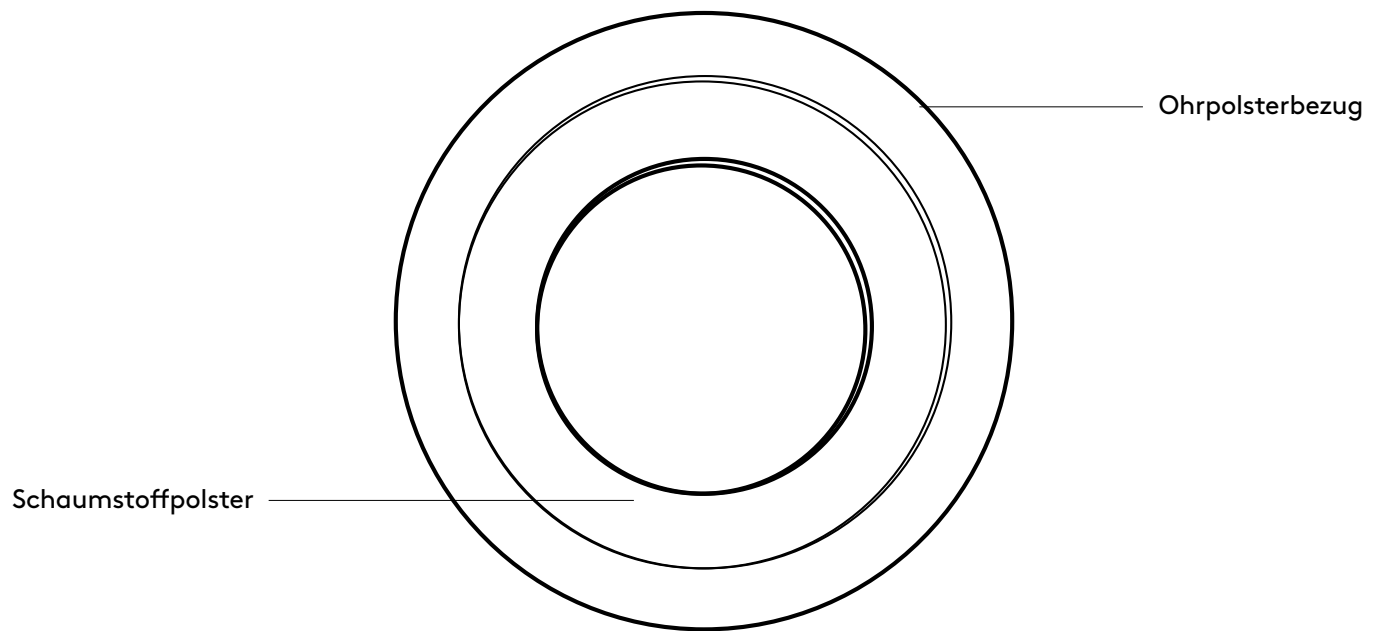

INHALT

1. 1 Paar (2 Stück) austauschbare Ohrpolsterbezüge
2. 1 Paar (2 Stück) Schaumstoffpolster
3. 1 Paar (2 Stück) Klebebänder

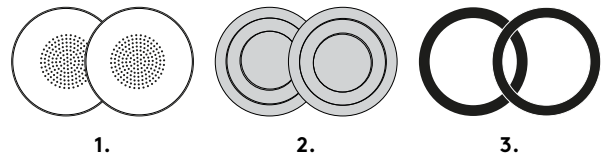

AUSTAUSCH DER OHRPOLSTER

1. Nehmen Sie den vorhandenen Ohrpolsterbezug ab, indem Sie ihn vorsichtig zusammendrücken.

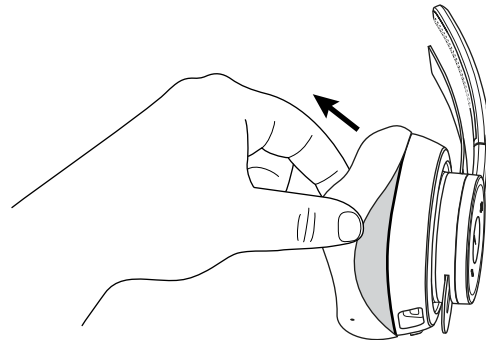

2. Entfernen Sie den Ohrpolsterbezug langsam, bis er vollständig abgenommen ist.

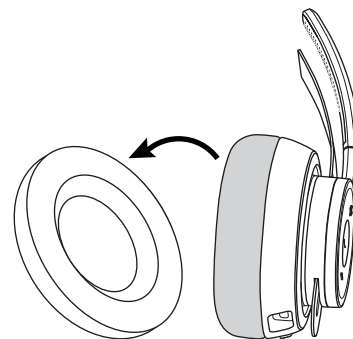

Achten Sie darauf, das Schaumstoffpolster, das leicht beschädigt werden kann, nicht zu fest zu drücken.

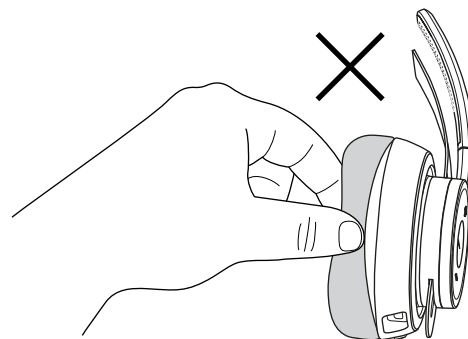

3. Wenn das Schaumstoffpolster beschädigt ist, gehen Sie bitte wie folgt vor.
- Ziehen Sie das Schaumstoffpolster ab und ersetzen Sie es durch ein neues.

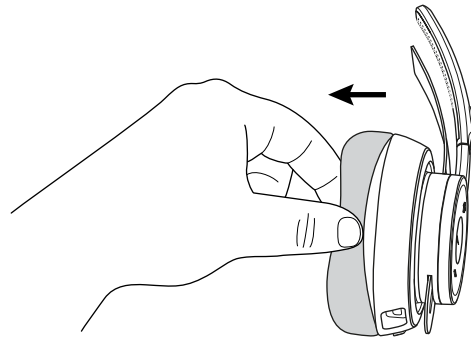

- Platzieren Sie das Klebeband zuerst oben auf der Ohrmuschel.
- Bringen Sie dann das Schaumstoffpolster am Klebeband an.

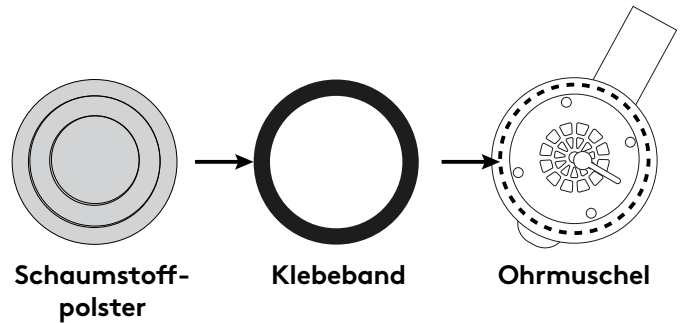

4. Nehmen Sie den neuen Ohrpolsterbezug und achten Sie darauf, dass sich die kleinen seitlichen Löcher an der Ober- und Unterseite der Ohrmuschel befinden. Sie sollte am USB-C-Anschluss auf der Unterseite ausgerichtet sein.

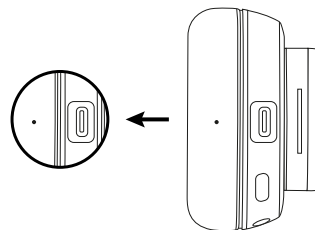

5. Beginnen Sie von oben und schieben Sie den Rand des Ohrpolsterbezugs in den Spalt. Legen Sie den Rand des Bezugs in den Spalt um die Hörmuschel.

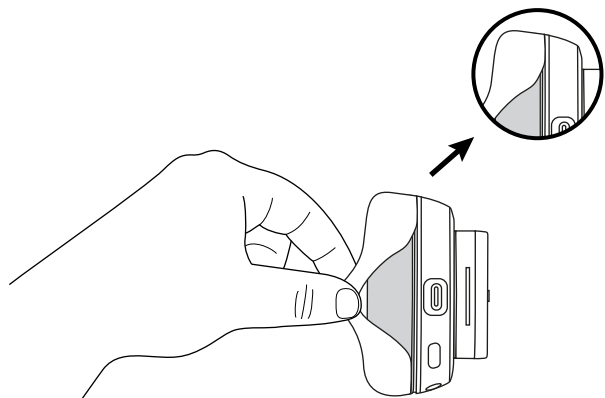

6. Klopfen Sie nach Fertigstellung mehrmals vorsichtig auf die Hörmuschel, um die Luft herauszudrücken.

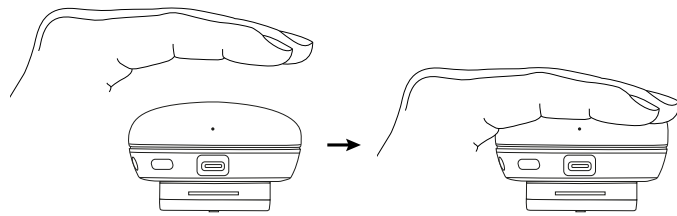

ABMESSUNGEN

OHRPOLSTERBEZÜGE:

Höhe x Breite x Tiefe: 70,7 mm x 70,7 mm x 16,4mm

www.logitech.com/support/zone-wireless-earpad-covers

PRÉSENTATION DU PRODUIT

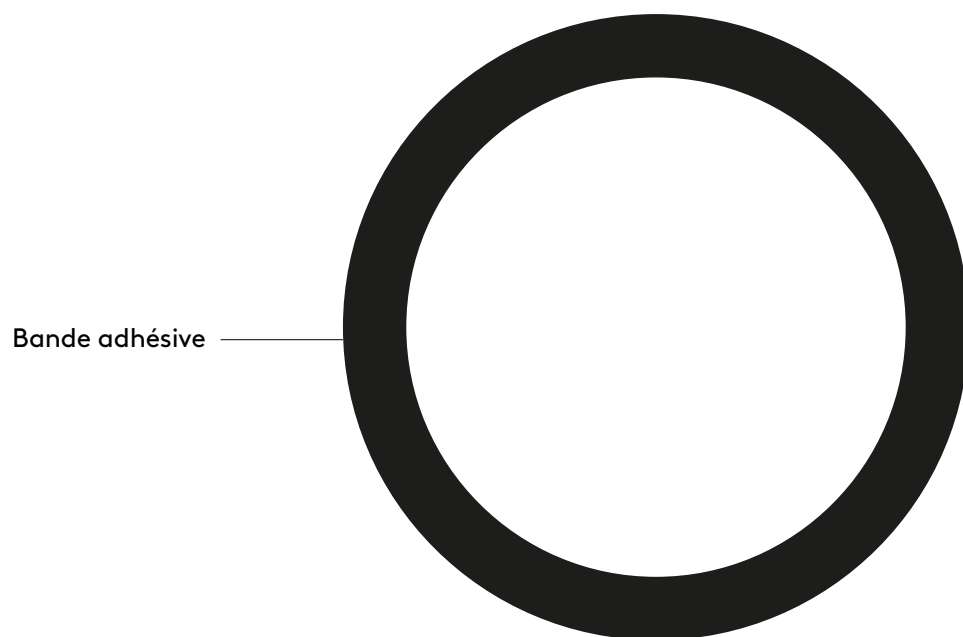
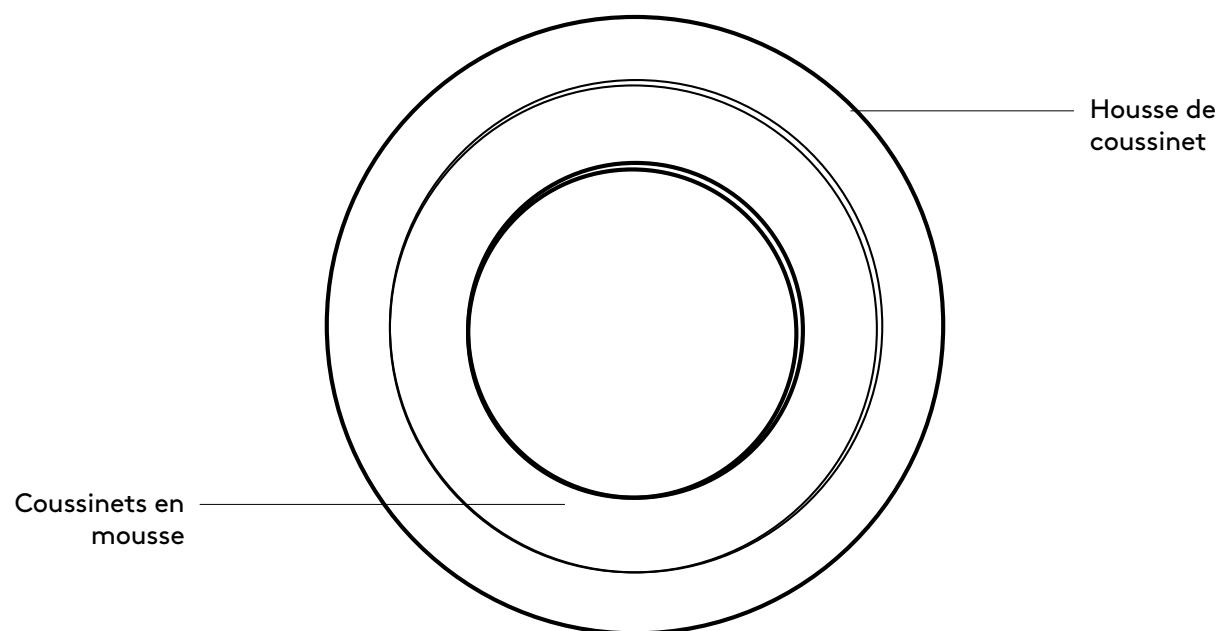

CONTENU DU COFFRET

1. 1 paire (2 pièces) de housses de coussinets remplaçables
2. 1 paire (2 pièces) de coussinets en mousse
3. 1 paire (2 pièces) de bandes adhésives

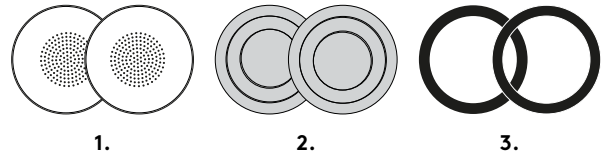

REPLACER LES HOUSSES DE COUSSINETS

1. Retirez la housse du coussinet existant en la pinçant délicatement.

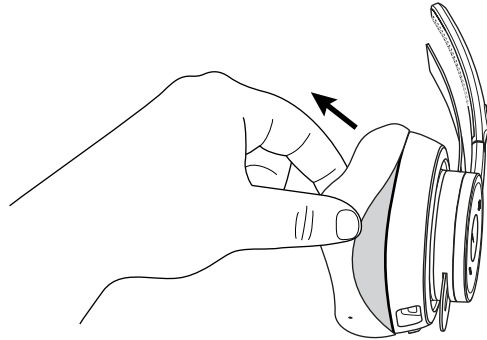

2. Enlevez lentement la housse du coussinet jusqu'à ce qu'elle soit entièrement retirée.

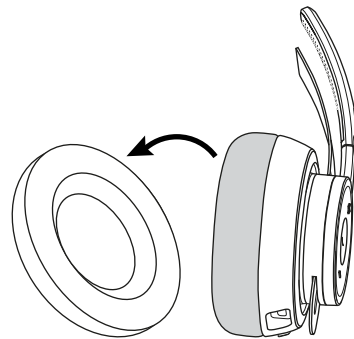

Veillez à ne pas pincer le coussinet en mousse qui peut être facilement endommagé.

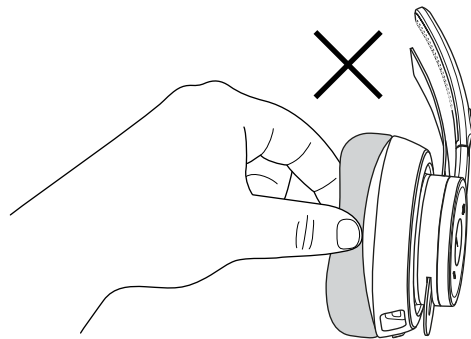

3. Si le coussinet en mousse est endommagé, veuillez suivre les étapes ci-dessous.
- Retirez le coussinet en mousse et remplacez-le par un nouveau.

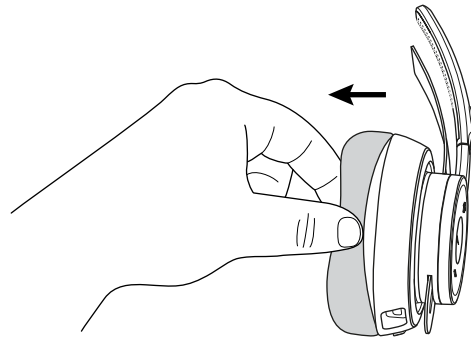

- Placez d'abord la bande adhésive sur le dessus de l'oreillette.

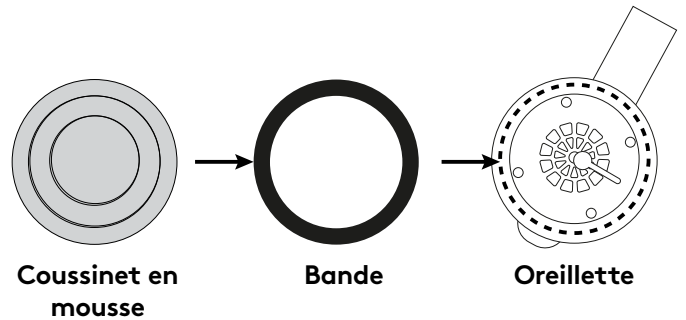

- Ensuite, fixez le coussinet en mousse à la bande.

4. Saisissez la nouvelle housse de coussinet en vous assurant que les petits trous sur le côté soient alignés avec le haut et le bas de l'oreillette. Elle doit être alignée avec le port USB C en bas.

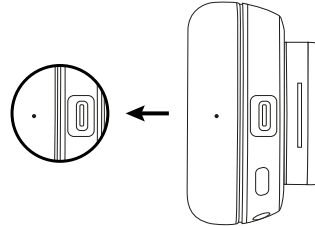

5. En commençant par le haut, insérez le bord de la housse du coussinet dans l'espace prévu à cet effet. Placez le bord de la housse dans l'espace autour de l'oreillette.

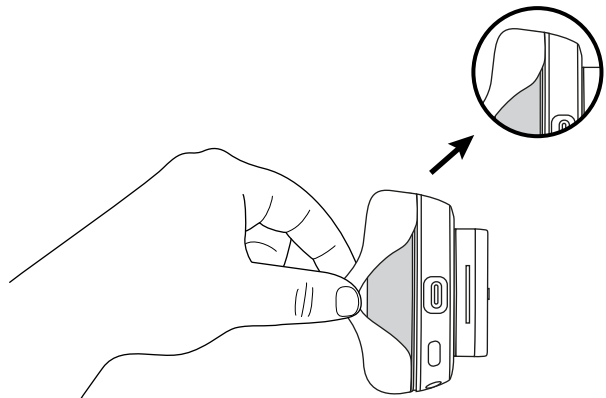

6. Après avoir terminé, tapotez délicatement l'oreillette plusieurs fois pour faire sortir l'air.

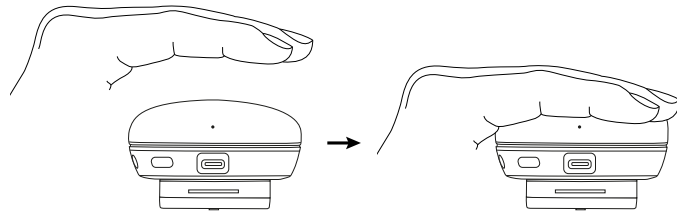

DIMENSIONS

HOUSES DE COUSSINETS:

Hauteur x Largeur x Épaisseur: 70,7 mm x 70,7 mm x 16,4mm

www.logitech.com/support/zone-wireless-earpad-covers

PANORAMICA DEL PRODOTTO

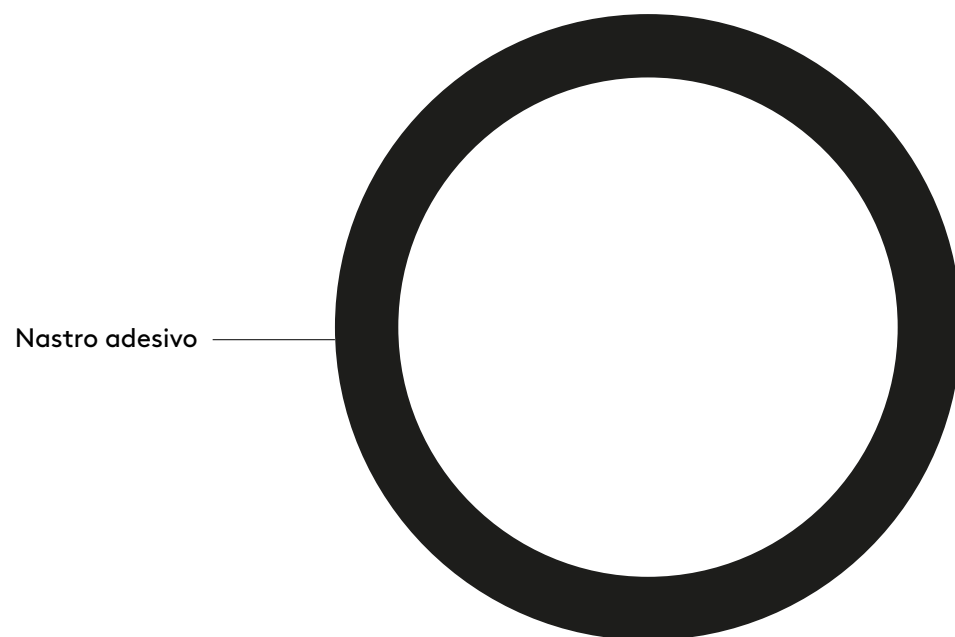
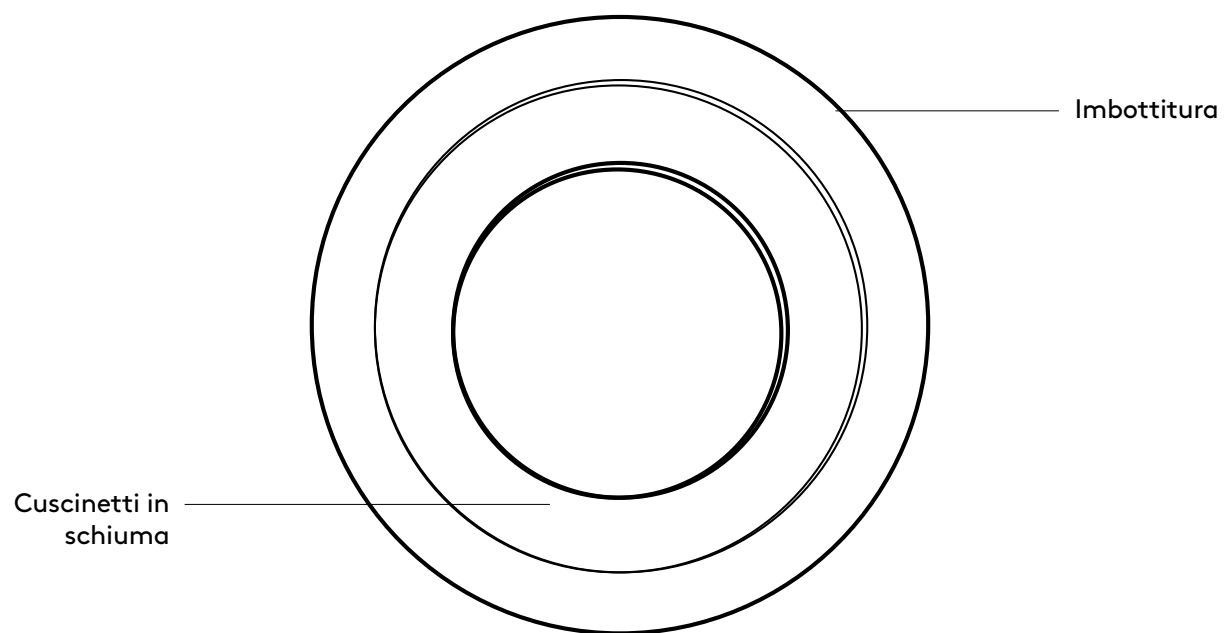

CONTENUTO DELLA CONFEZIONE

1. 1 paio (2 pezzi) di imbottiture sostituibili
2. 1 paio (2 pezzi) di cuscinetti in schiuma
3. 1 paio (2 pezzi) di nastri adesivi

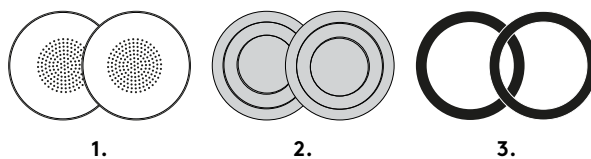

SOSTITUZIONE DELLE IMBOTTITURE

1. Rimuovere l'imbottitura esistente stringendola delicatamente con il pollice e l'indice.

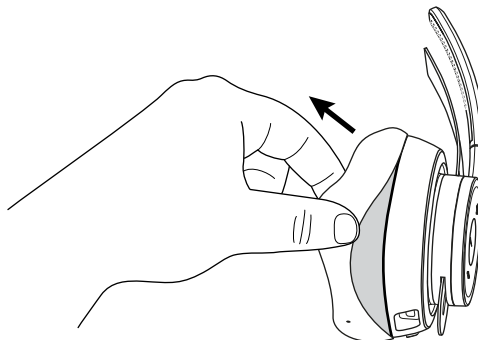

2. Rimuovere lentamente l'imbottitura fino a quando non si è staccata completamente.

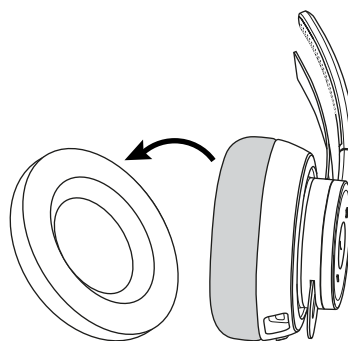

Fare attenzione a non pizzicare il cuscinetto di schiuma, in quanto può danneggiarsi facilmente.

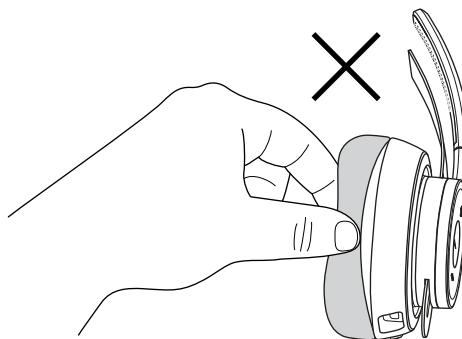

3. Se il cuscinetto di schiuma è danneggiato, seguire questa procedura.

a. Staccare il cuscinetto di schiuma e sostituirlo con uno nuovo.

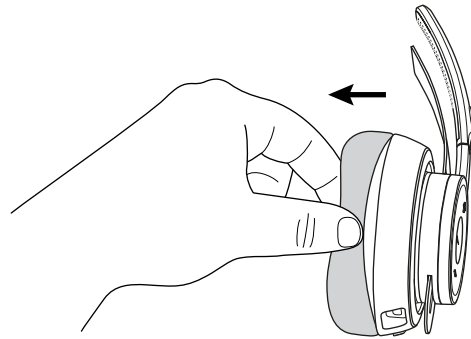

b. Applicare il nastro adesivo all'auricolare.

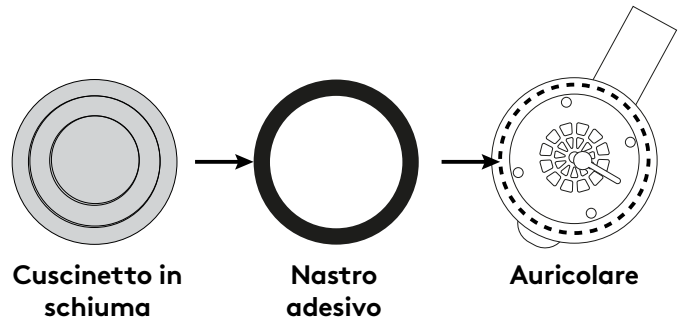

c. Quindi applicare il cuscinetto di schiuma al nastro adesivo.

4. Afferrare la nuova imbottitura facendo attenzione che i piccoli fori sul lato siano allineati con la parte superiore e inferiore dell'auricolare. Devono allinearsi con la porta USB C in basso.

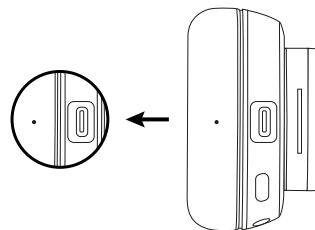

5. Partendo dall'alto, inserire il bordo dell'imbottitura all'interno della fessura. Inserire il bordo dell'imbottitura nella fessura dell'auricolare.

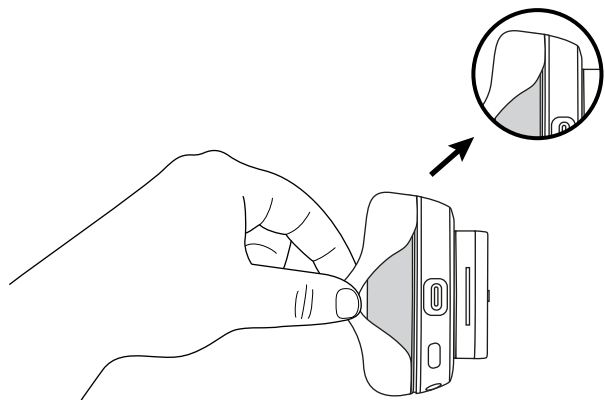

6. Al termine, premere delicatamente l'imbottitura più volte per far uscire l'aria.

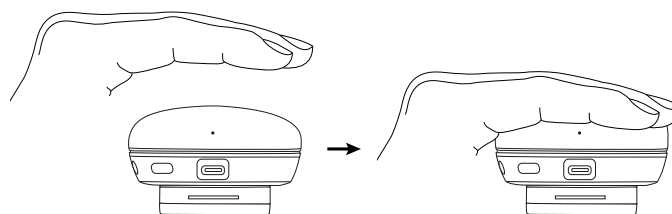

DIMENSIONI

IMBOTTITURE:

Altezza x Larghezza x Profondità: 70,7 mm x 70,7 mm x 16,4mm

www.logitech.com/support/zone-wireless-earpad-covers

COMPONENTES DEL PRODUCTO

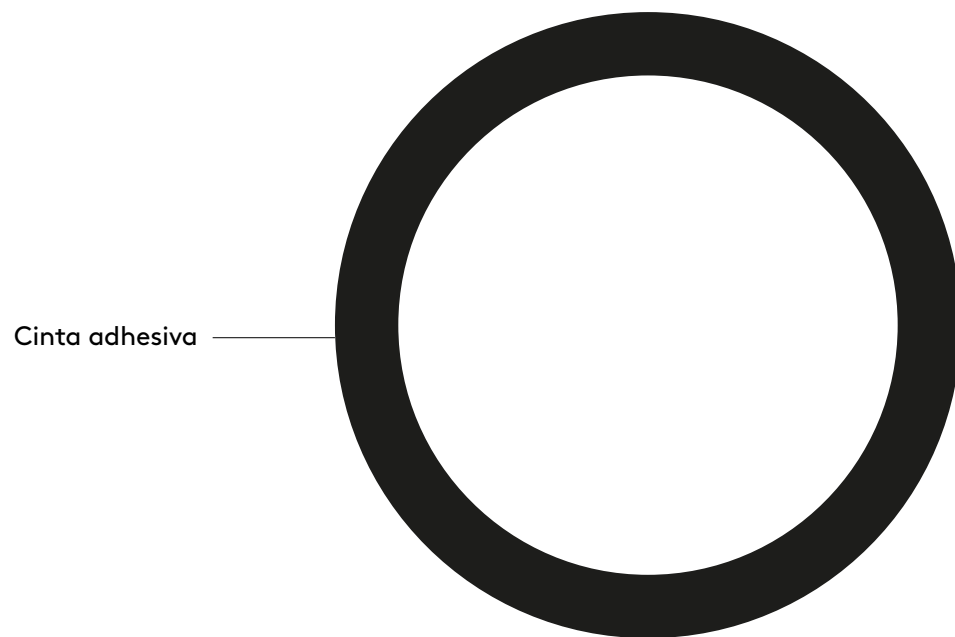
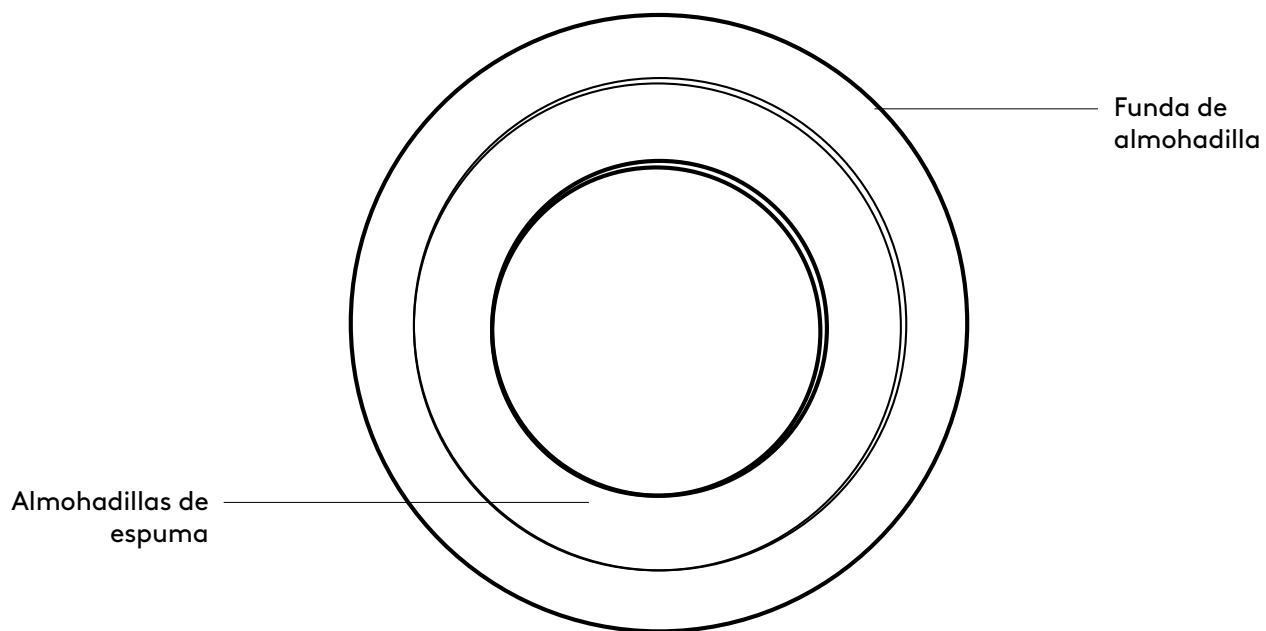

CONTENIDO DE LA CAJA

1. 1 par (2 unidades) de fundas de almohadillas sustituibles
2. 1 par (2 unidades) de almohadillas de espuma
3. 1 par (2 unidades) de cintas adhesivas

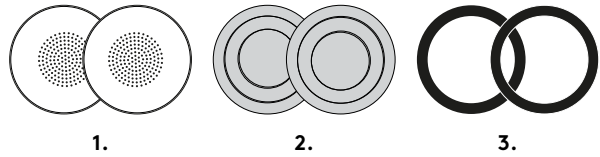

SUSTITUIR LAS FUNDAS DE ALMOHADILLAS

1. Quite la funda de almohadilla existente. Para ello, pellízquela con cuidado.

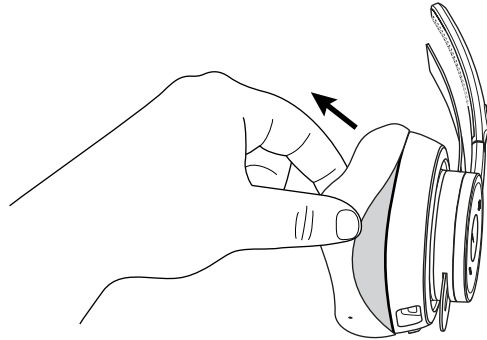

2. Retire lentamente la funda de almohadilla hasta que salga por completo.

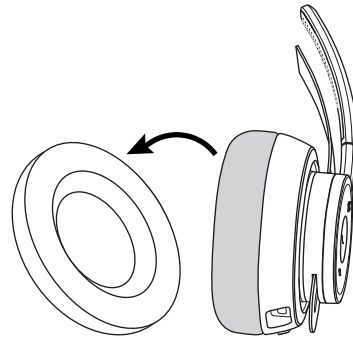

Asegúrese de no pellizcar la almohadilla de espuma ya que puede dañarse fácilmente.

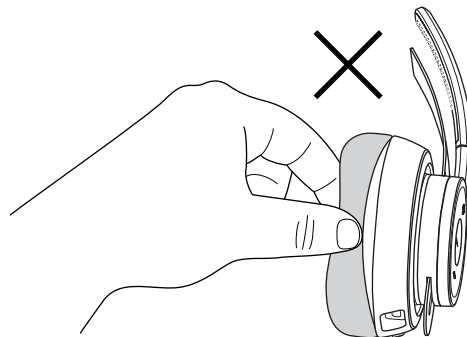

3. Si se daña la almohadilla de espuma, siga los pasos a continuación.

a. Retire la almohadilla de espuma y sustitúyala con una nueva.

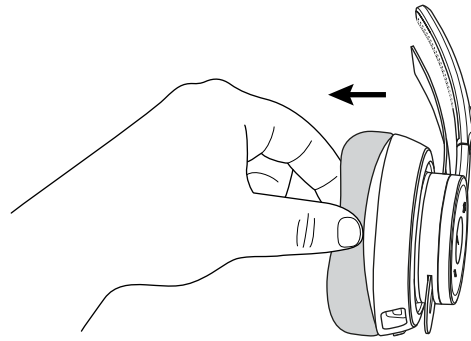

b. Coloque la cinta primero en la parte superior de la copa.

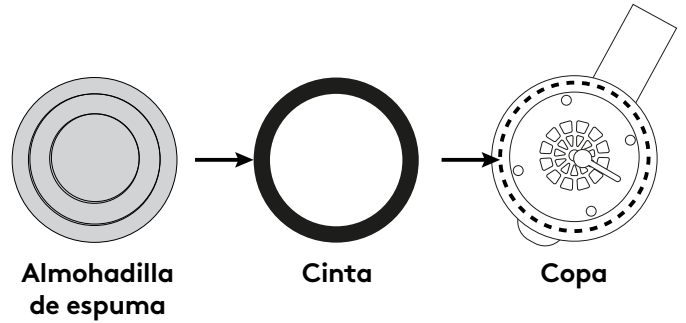

c. Luego adhiera la almohadilla de espuma a la cinta.

4. Agarre la nueva funda de almohadilla, asegurándose de que los pequeños agujeros en el lado se alineen con la parte superior e inferior de la copa. Debería alinearse con el puerto USB C en la parte inferior.

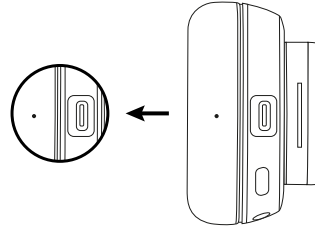

5. Empezando desde arriba, encaje el borde de la funda de almohadilla dentro del hueco. Ponga el borde de la funda en el hueco alrededor del auricular.

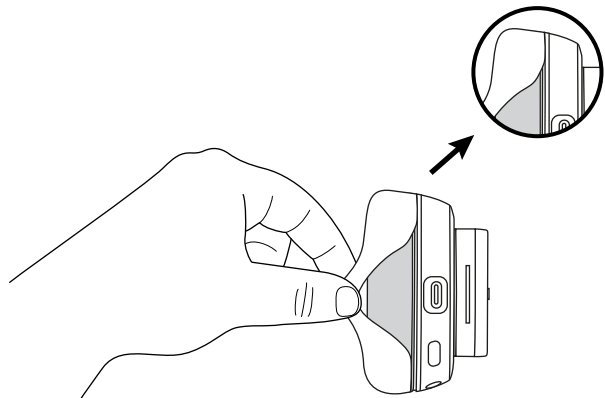

6. Después de terminar, palmeo suavemente la copa varias veces para expulsar el aire.

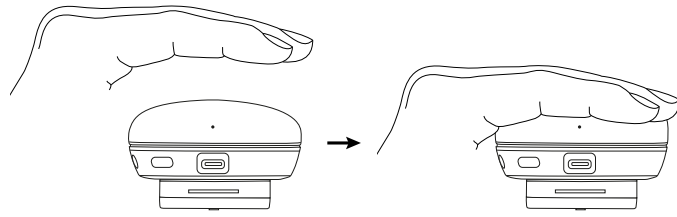

DIMENSIONES

FUNDAS DE ALMOHADILLAS:

Altura x Anchura x Profundidad: 70,7 mm x 70,7 mm x 16,4mm

www.logitech.com/support/zone-wireless-earpad-covers

CONHEÇA O SEU PRODUTO

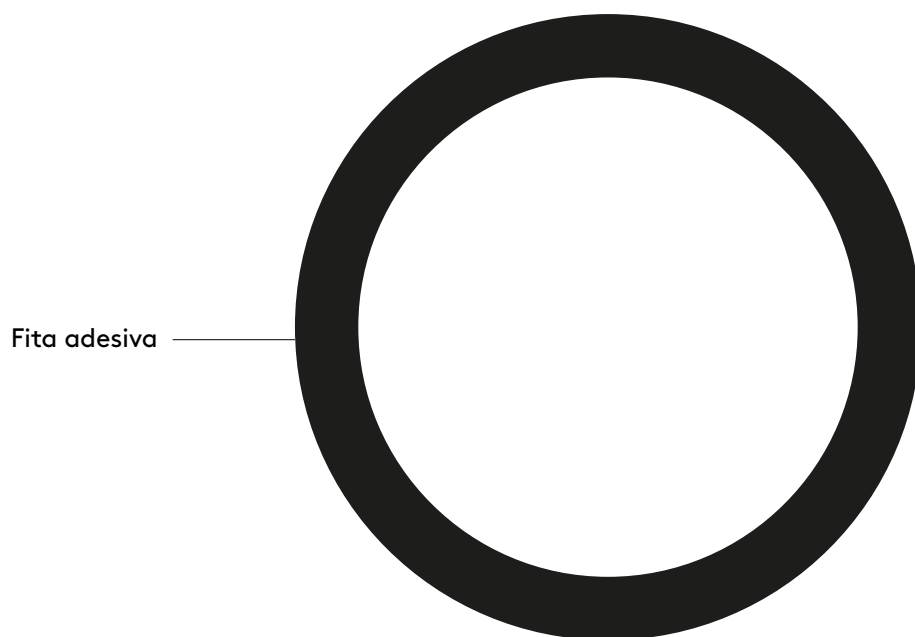
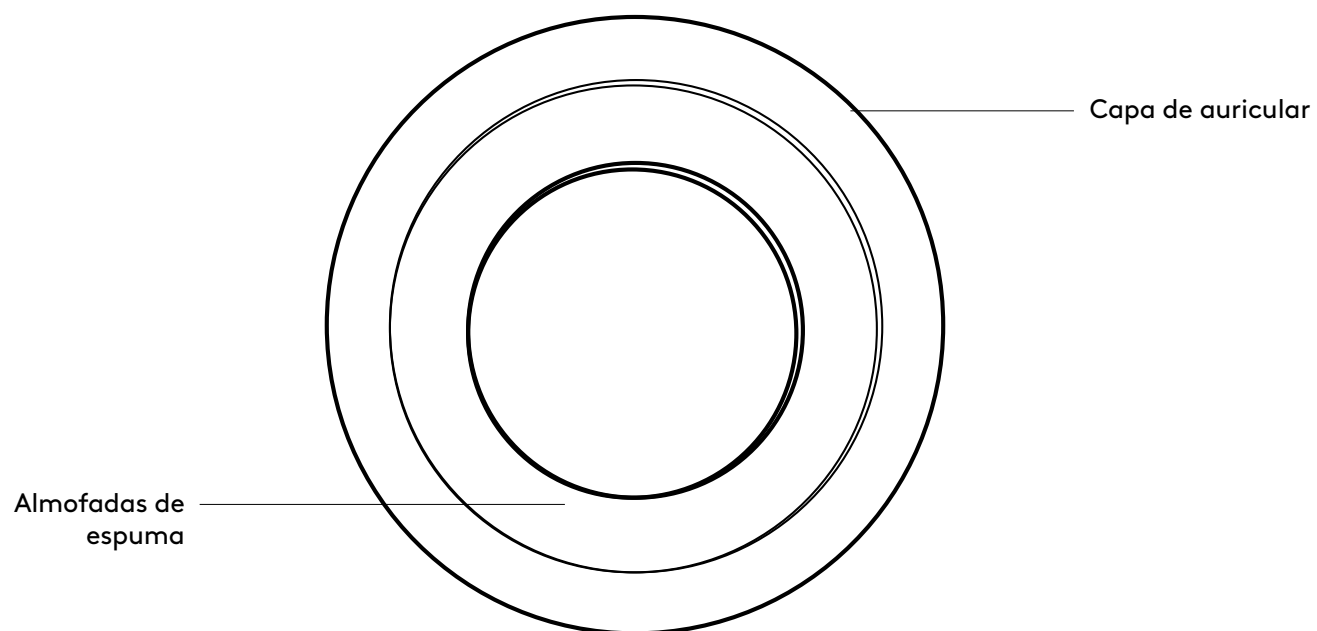

ITENS INCLUÍDOS NA EMBALAGEM

1. 1 par (2 unid.) de capas de auscultadores substituíveis
2. 1 par (2 unid.) de almofadas de espuma
3. 1 par (2 unid.) de fitas adesivas

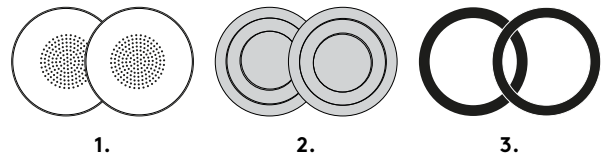

SUBSTITUIR CAPAS DOS AUSCULTADORES

1. Retire a capa do auricular existente, apertando a capa com cuidado.

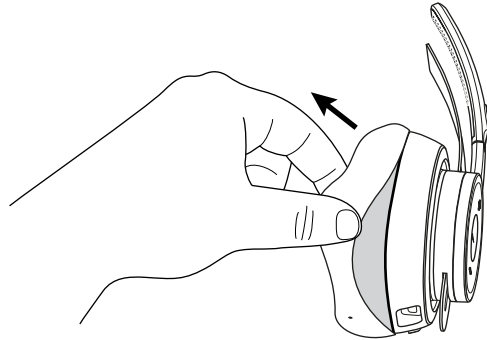

2. Retire a capa do auricular lentamente até sair completamente.

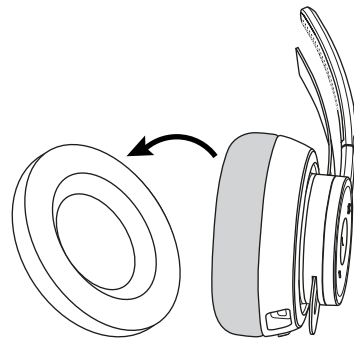

Tenha cuidado para não apertar a almofada de espuma que pode ser danificada facilmente.

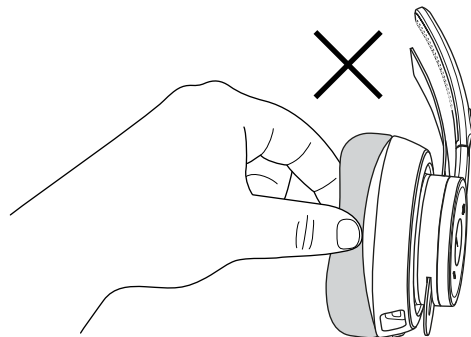

3. Se a almofada de espuma estiver danificada, siga os passos abaixo.
- Retire a almofada de espuma e substitua por uma nova.

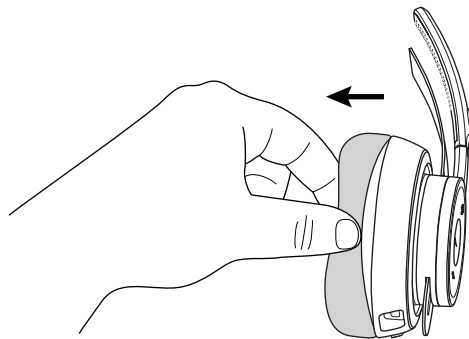

- Coloque primeiro a fita adesiva na parte superior do auricular.

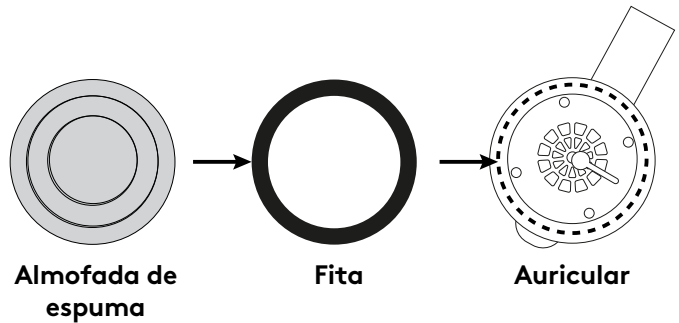

- Em seguida, instale a almofada de espuma na fita.

4. Segure a nova capa de auricular, certificando-se de que os pequenos orifícios laterais estão alinhados com a parte superior e inferior do auricular. Deve estar alinhada com a porta USB-C na parte inferior.

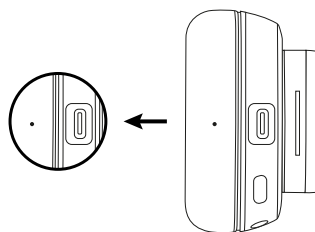

5. Começando na parte superior, encaixe a extremidade da capa do auricular na ranhura. Coloque a extremidade da capa na ranhura em volta do auricular.

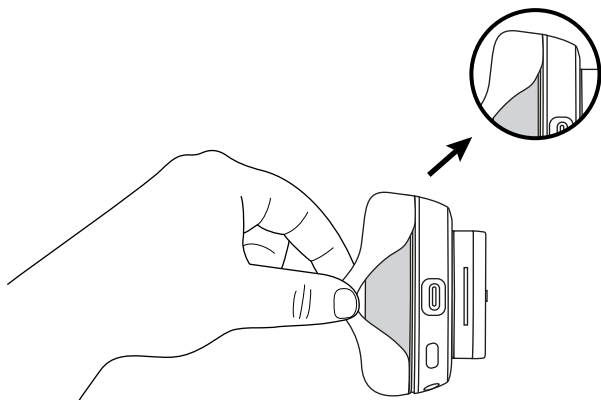

6. Após concluir, dê uns toques no auricular para retirar o ar.

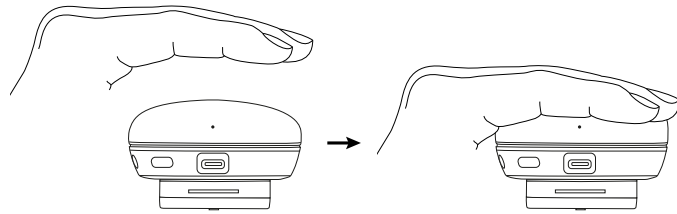

DIMENSÕES

CAPAS DE AURICULAR:

Altura x largura x profundidade: 70,7 mm x 70,7 mm x 16,4mm

www.logitech.com/support/zone-wireless-earpad-covers

KEN UW PRODUCT

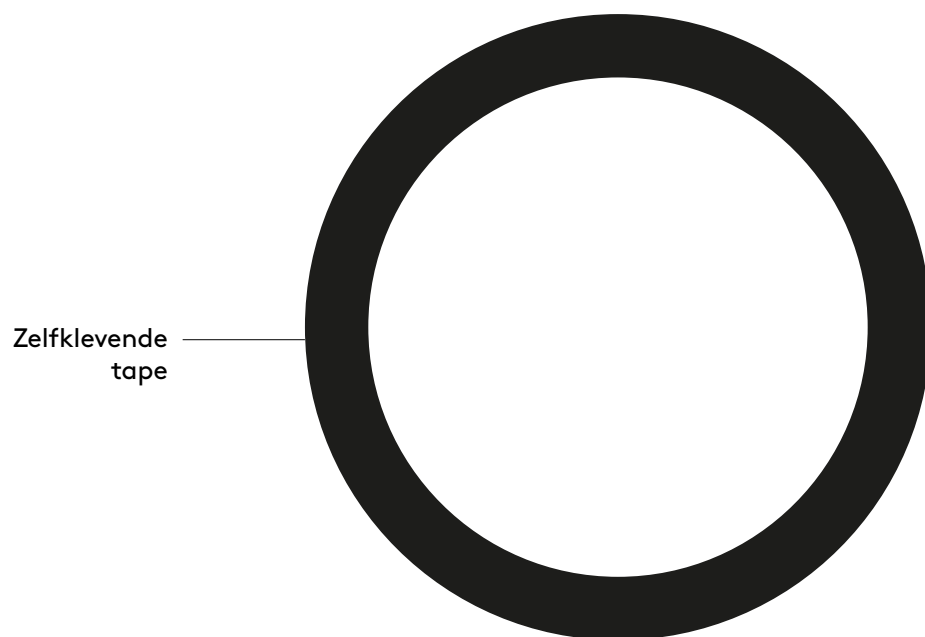
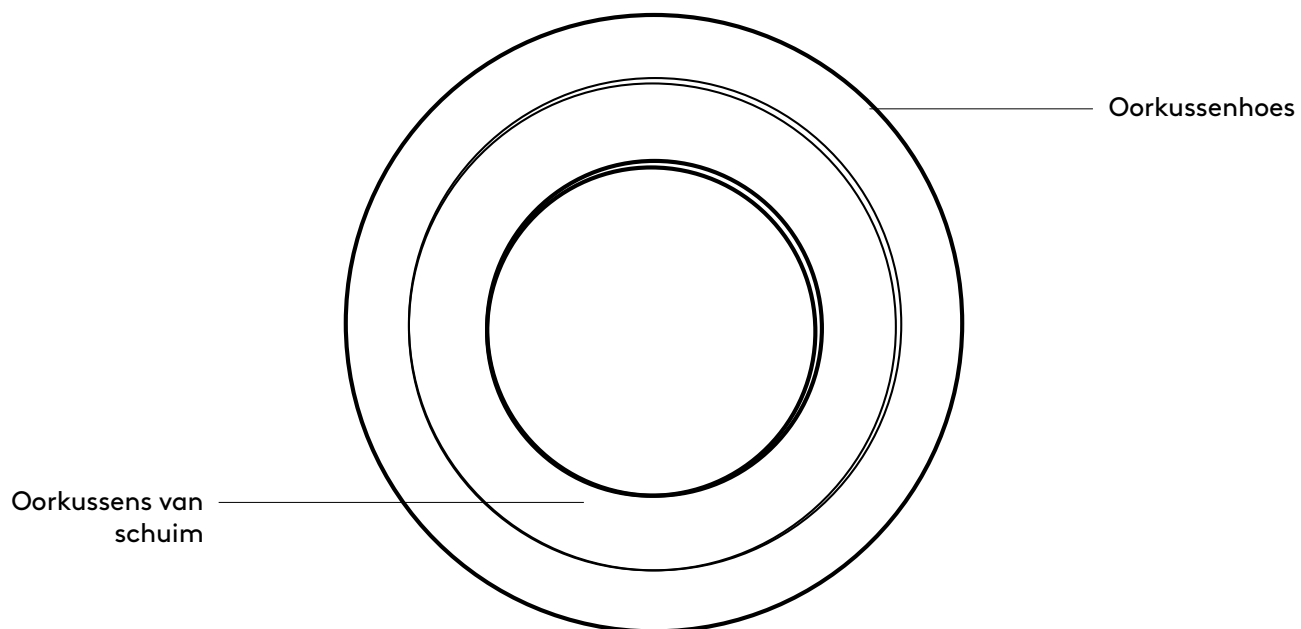

INHOUD VAN DE DOOS

1. 1 paar (2 stuks) verwisselbare oorkussenhoezen
2. 1 paar (2 stuks) oorkussens van schuim
3. 1 paar (2 stuks) zelfklevende tape

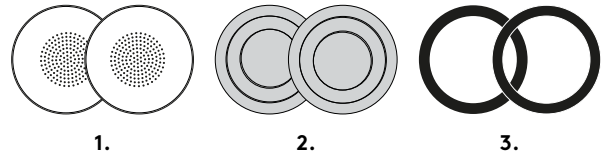

DE OORKUSSENHOEZEN VERVANGEN

1. Verwijder het bestaande hoes door voorzichtig in de hoes te knijpen.

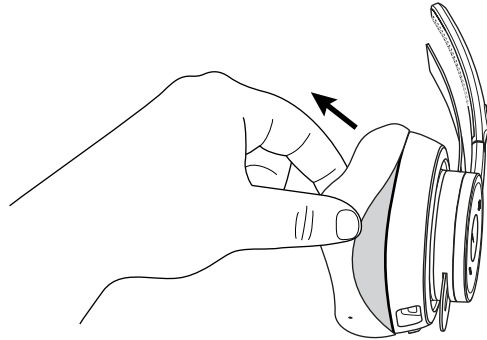

2. Verwijder de hoes langzaam tot het volledig verwijderd is.

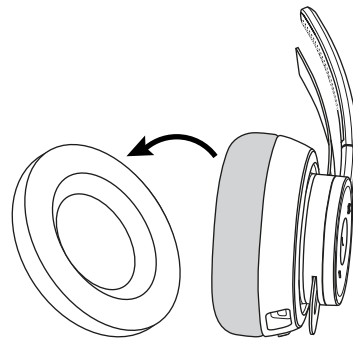

Zorg dat u niet in het schuim knijpt. Dit kan gemakkelijk beschadigen.

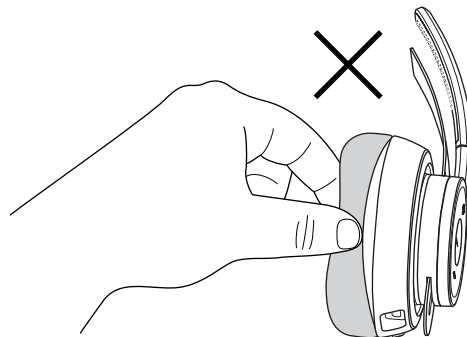

3. Volg de onderstaande stappen als het oorkussen van schuim beschadigd is.
- Verwijder het kussen van schuim en vervang het door een nieuw exemplaar.

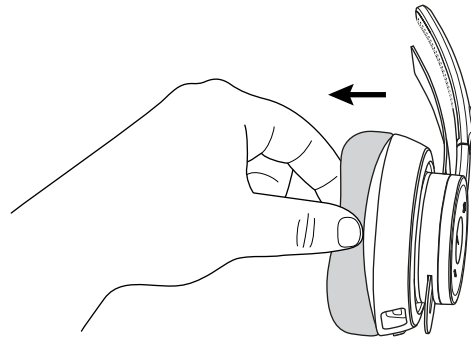

- Plaats de tape eerst op de bovenkant van het oorstuk.

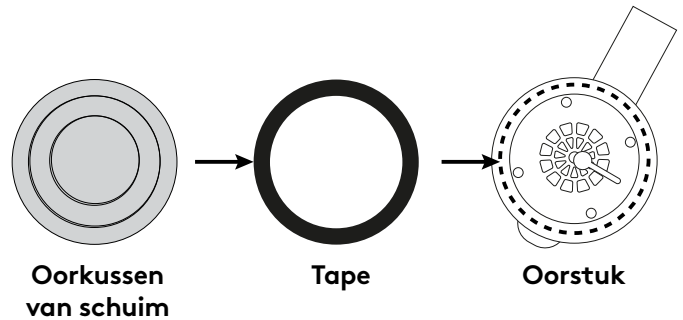

- Plaats vervolgens het kussen van schuim op de tape.

4. Neem de nieuwe hoes en zorg dat de kleine gaatjes aan de zijkant zijn uitgelijnd met de boven- en onderkant van het oorstuk. Het moet zijn uitgelijnd met de USB C-poort aan de onderkant.

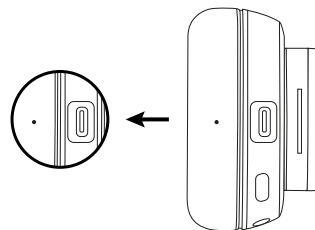

5. Begin bovenaan en steek de rand van de hoes in de opening. Plaats de rand van de hoes in de opening rond het oorstuk.

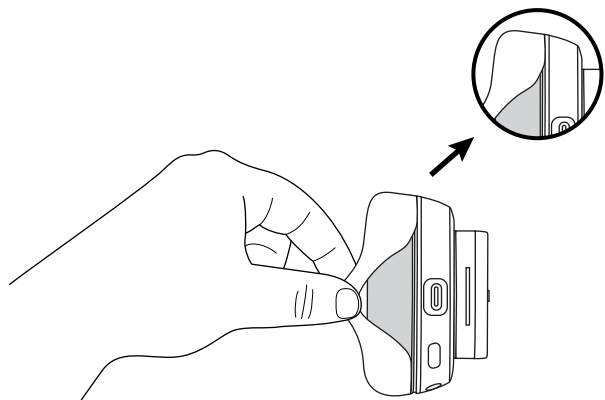

6. Klop na afloop een paar keer zachtjes op het oorstuk om de lucht eruit te duwen.

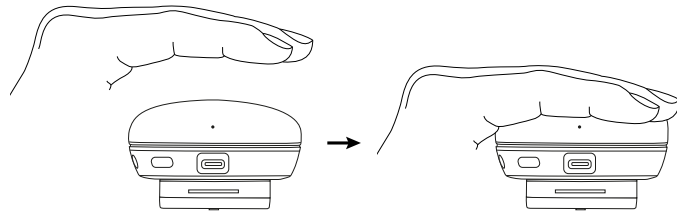

AFMETINGEN

OORKUSSENHOEZEN:

Hoogte x breedte x diepte: 70,7 mm x 70,7 mm x 16,4mm

www.logitech.com/support/zone-wireless-earpad-covers

PRODUKTÖVERSIKT

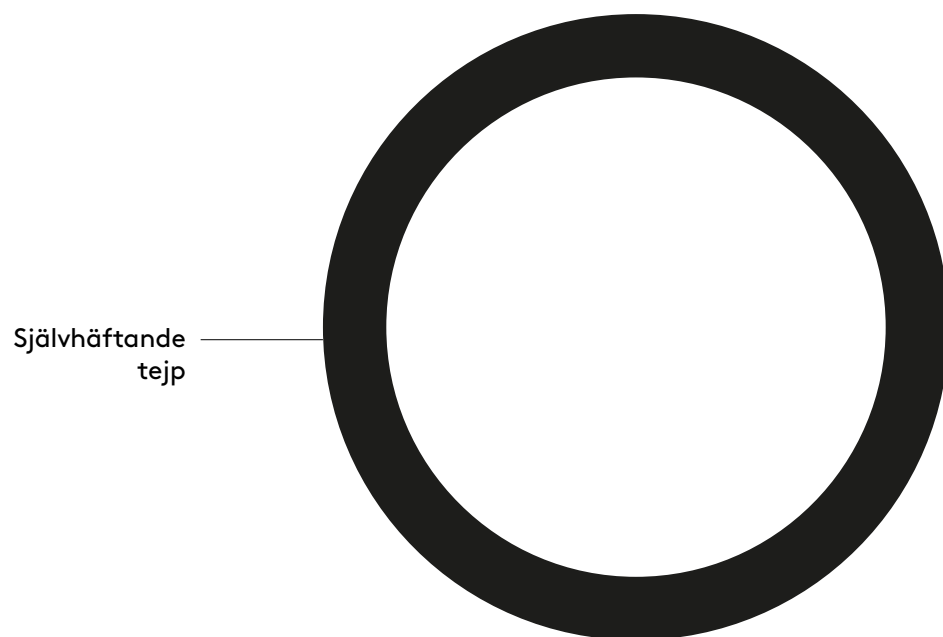
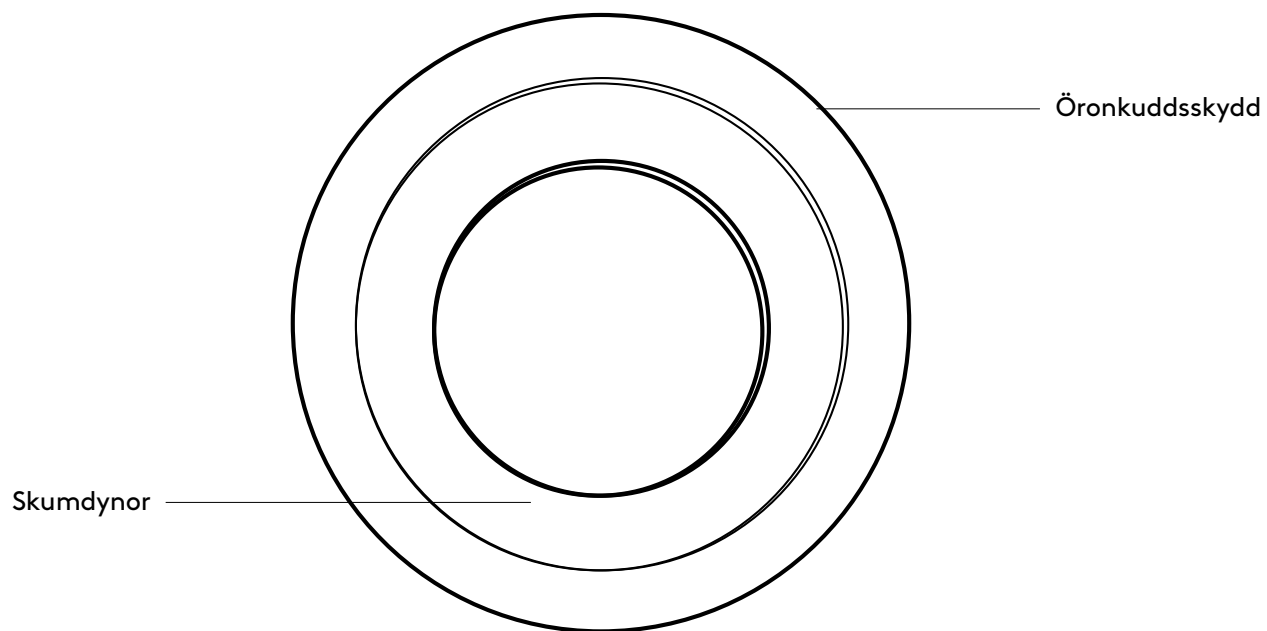

INNEHÅLL

1. Ett par (2 delar) utbytbara öronkuddsskydd
2. Ett par (2 delar) skumdynor
3. Ett par (2 delar) med självhäftande tejp

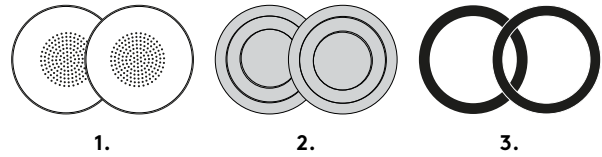

BYTA UT ÖRONKUDDSSKYDDEN

1. Ta bort det befintliga öronkuddsskyddet genom att försiktigt nypa i skyddet.

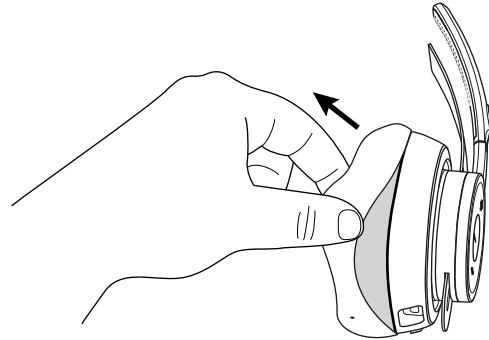

2. Ta långsamt bort öronkuddsskyddet tills det är helt av.

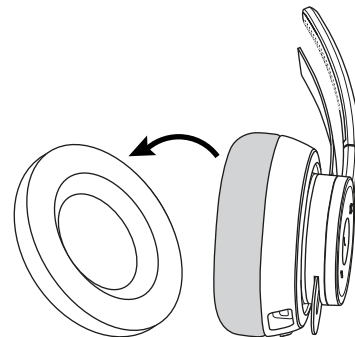

Se till att inte nypa i skumdynan eftersom den lätt kan skadas.

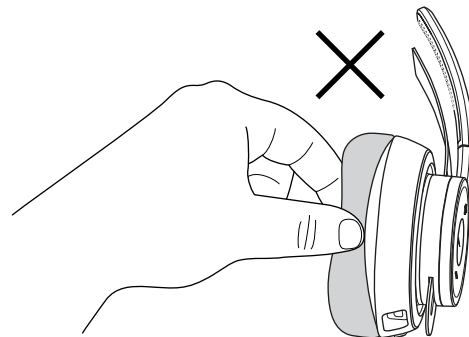

3. Om skumdynan är skadad följer du stegen nedan.

a. Ta av skumdynan och ersätt den med en ny.

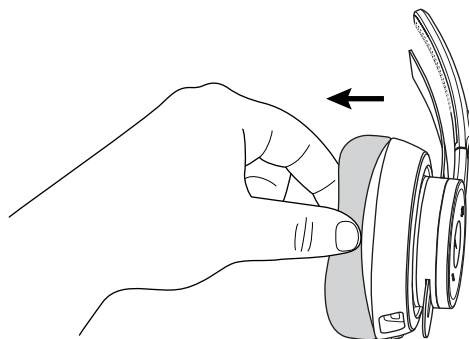

b. Placera först tejen högst upp på öronkudden.

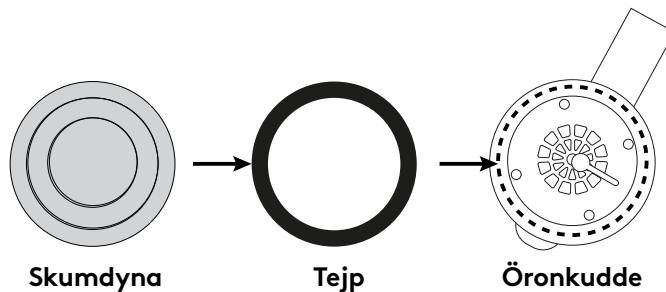

c. Fäst sedan skumdynan på tejen.

4. Ta det nya öronkuddsskyddet och se till att de små hålen på sidan hamnar i linje med toppen och botten av öronkudden. Det ska hamna i linje med USB-C-porten längst ner.

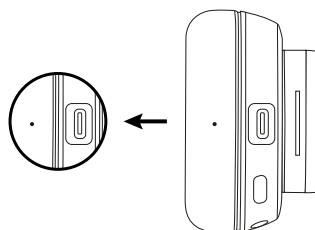

5. Starta högst upp och passa in kanten av öronkuddsskyddet i hålet. Placera kanten på skyddet in i hålet runt öronkanalen.

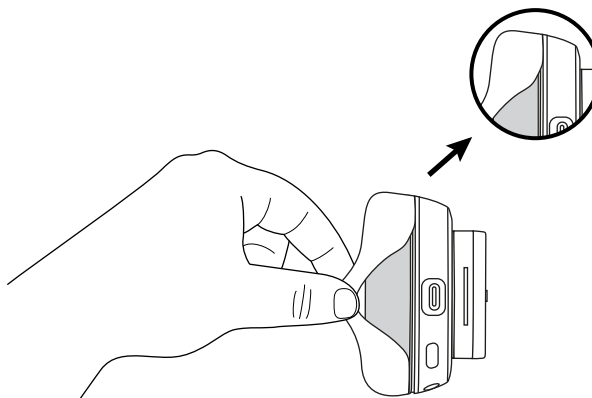

6. När det är klart ska du försiktigt klappa på öronkudden flera gånger för att pressa ut luften.

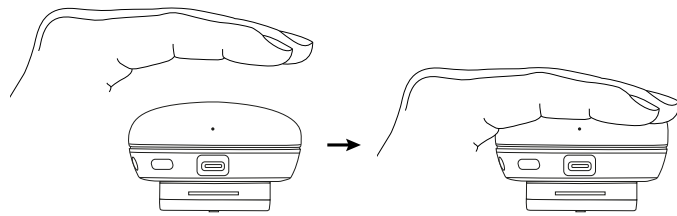

MÅTT

ÖRONKUDDSSKYDD:

Höjd x bredd x djup: 70,7 mm x 70,7 mm x 16,4mm

www.logitech.com/support/zone-wireless-earpad-covers

PRODUKTOVERSIGT

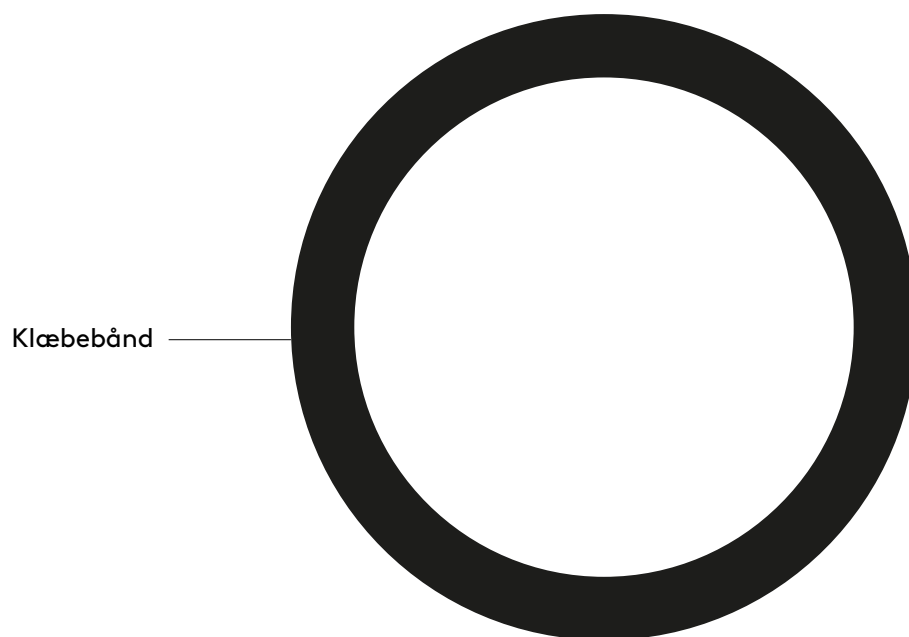
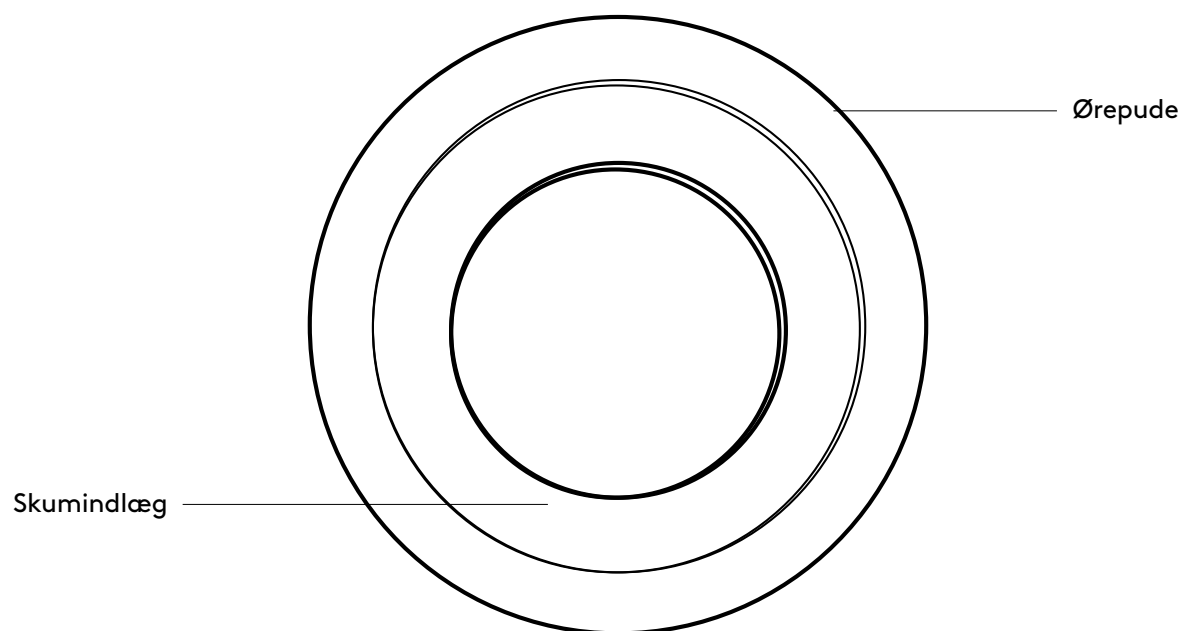

DET INDEHOLDER KASSEN

1. 1 par (2 stk) udskiftningsørepunder
2. 1 par (2 stk) skumindlæg
3. 1 par (2 stk) klæbebånd

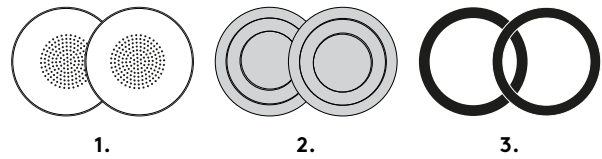

UDSKIFTNING AF ØREPUDER

1. Fjern den eksisterende ørepude ved forsigtigt at klemme den.

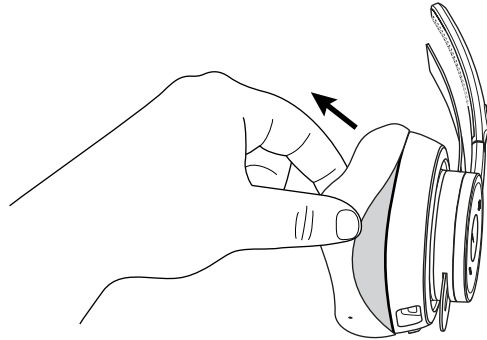

2. Fjern ørepuden langsomt indtil den er kommet helt af.

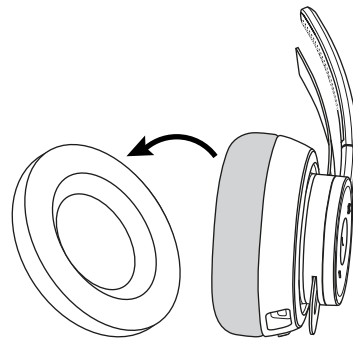

Sørg for ikke at klemme skumindlægget da det let kan beskadiges.

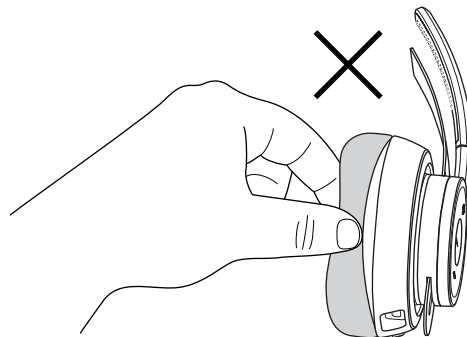

3. Hvis skumindlægget beskadiges, skal du følge nedenstående trin.
- Fjern skummet, og sæt nyt på.

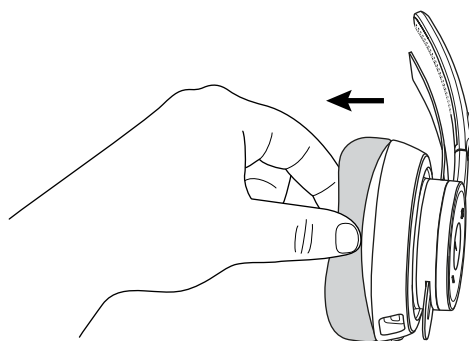

- Sæt klæbebåndet på ørestykket.

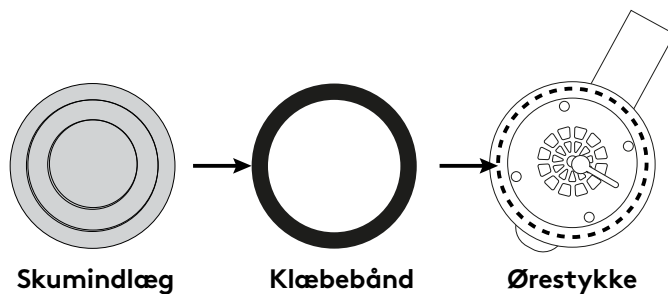

- Sæt derefter skumindlægget fast til klæbebåndet.

4. Tag fat i den nye ørepude, og sørg for at de små huller på siden vender rigtigt i forhold til toppen og bunden af ørestykket. Det skal passe til USB C-porten i bunden.

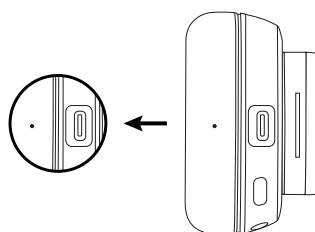

5. Begynd øverst, og pres kanten af ørepuden ind i åbningen. Fortsæt langs åbningen hele vejen rundt om ørestykket.

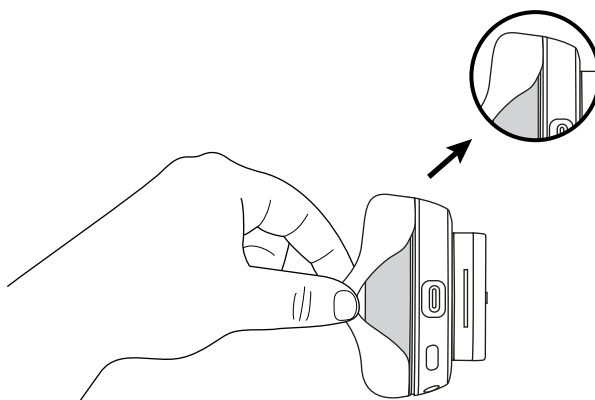

6. Når du er færdig, bank forsigtigt på ørestykket nogle gange for at få evt. luft ud.

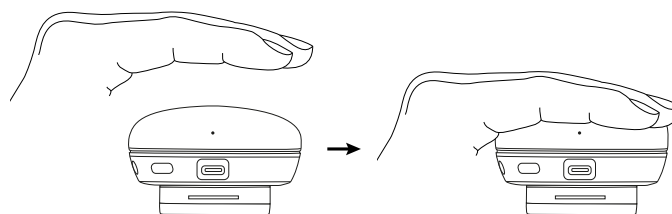

MÅL

ØREPUDER:

Højde x bredde x dybde: 70,7 mm x 70,7 mm x 16,4mm

www.logitech.com/support/zone-wireless-earpad-covers

BLI KJENT MED PRODUKTET

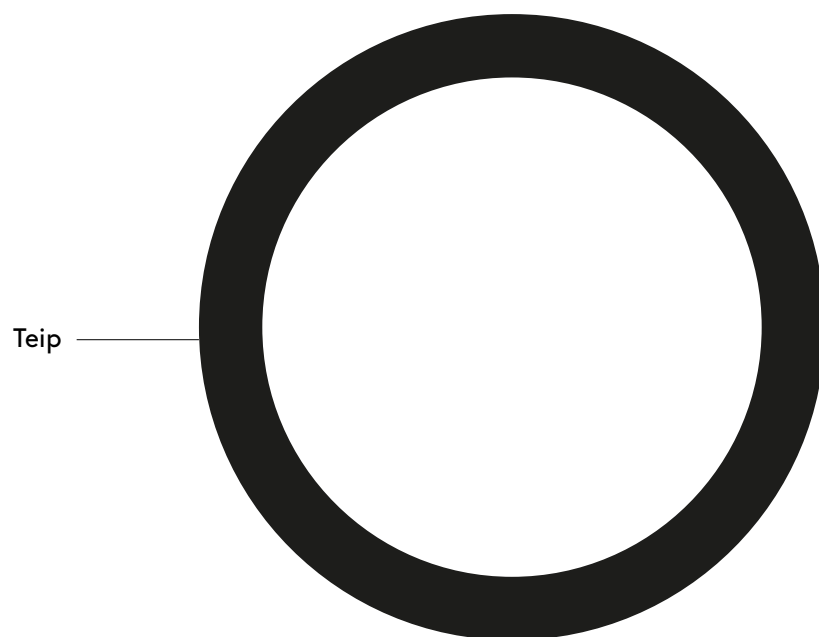
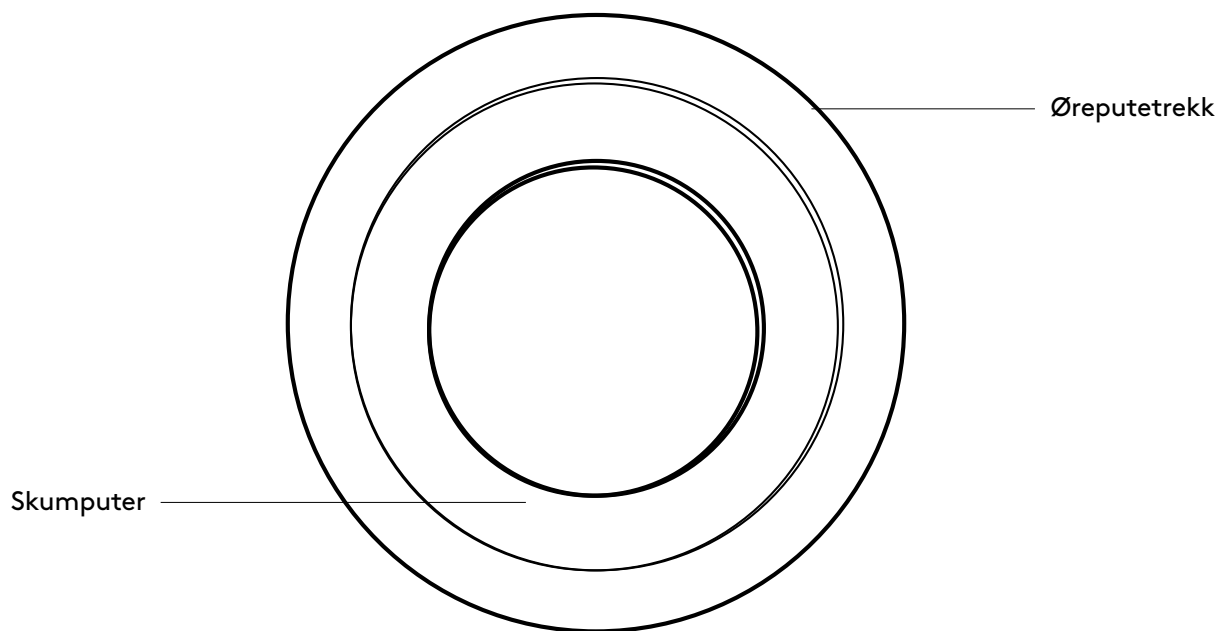

I ESKEN

1. 1 par (2 stk.) utskiftbare øreputetrekk
2. 1 par (2 stk.) skumputer
3. 1 par (2 stk.) teipremser

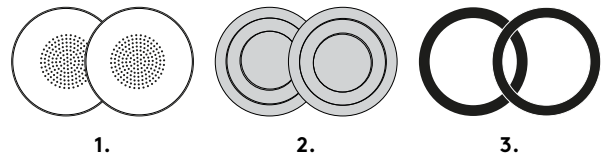

SKIFTE UT ØREPUTETREKK

1. Ta av det gamle øreputetrekket ved å klemme forsiktig i det.

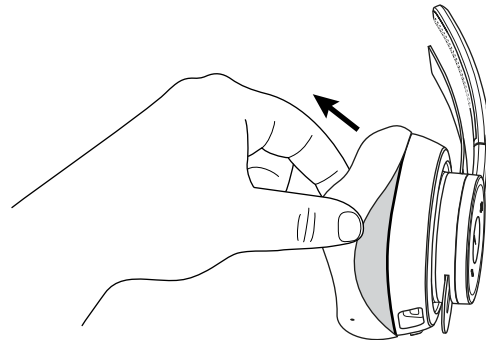

2. Trekk øreputetrekket langsomt av.

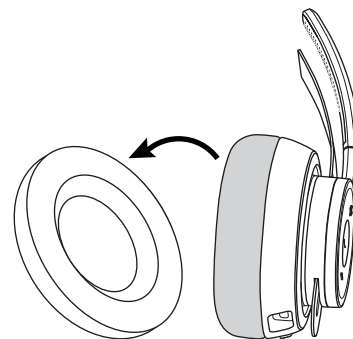

Pass på at du ikke klemmer skumputen – den kan lett ta skade.

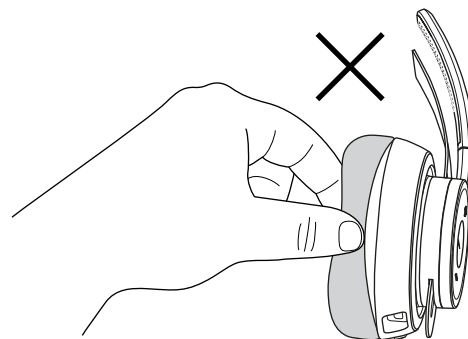

3. Hvis skumputen er skadet, følger du trinnene nedenfor.

a. Trekk av skumputen og sett på en ny.

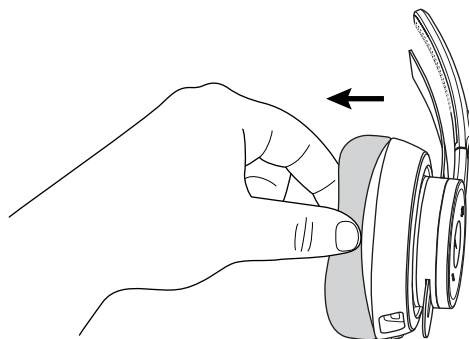

b. Plasser først teipen øverst på øreklokken.

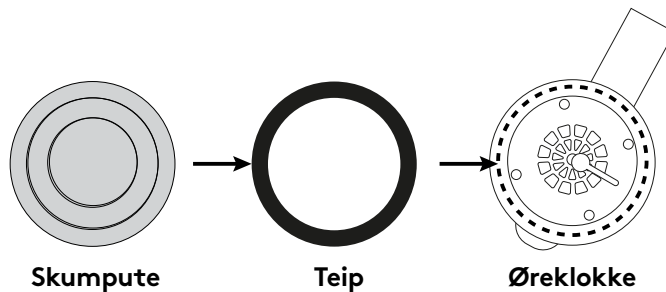

c. Deretter fester du skumputen til teipen.

4. Ta tak i det nye øreputetrekket, og pass på at de små hullene på siden stemmer overens med toppen og bunnen av øreklokken. Den skal stemme overens med USB C-porten nederst.

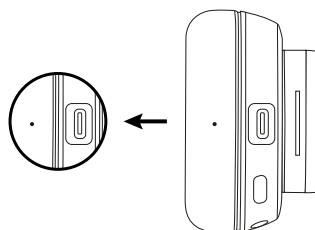

5. Begynn fra toppen og plasser kanten av øreputetrekket inni åpningen. Plasser kanten på trekket i åpningen rundt øreklokken.

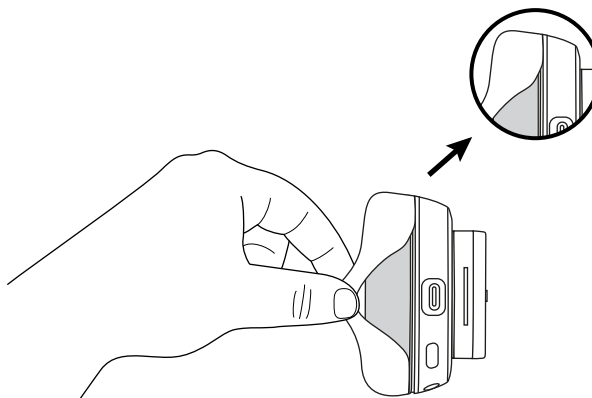

6. Når du er ferdig, klapper du forsiktig på øreklokken for å fjerne luften.

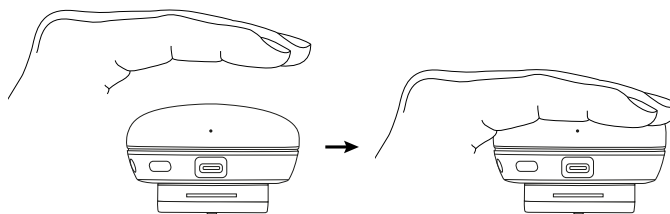

MÅL

ØREPUTETREKK:

Høyde x bredde x dybde: 70,7 mm x 70,7 mm x 16,4mm

www.logitech.com/support/zone-wireless-earpad-covers

TUNNE TUOTTEESI

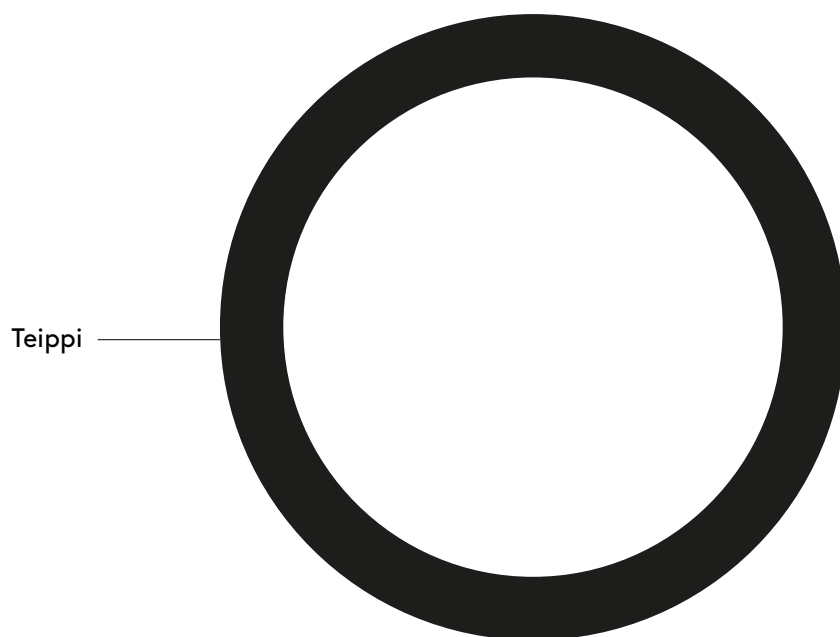
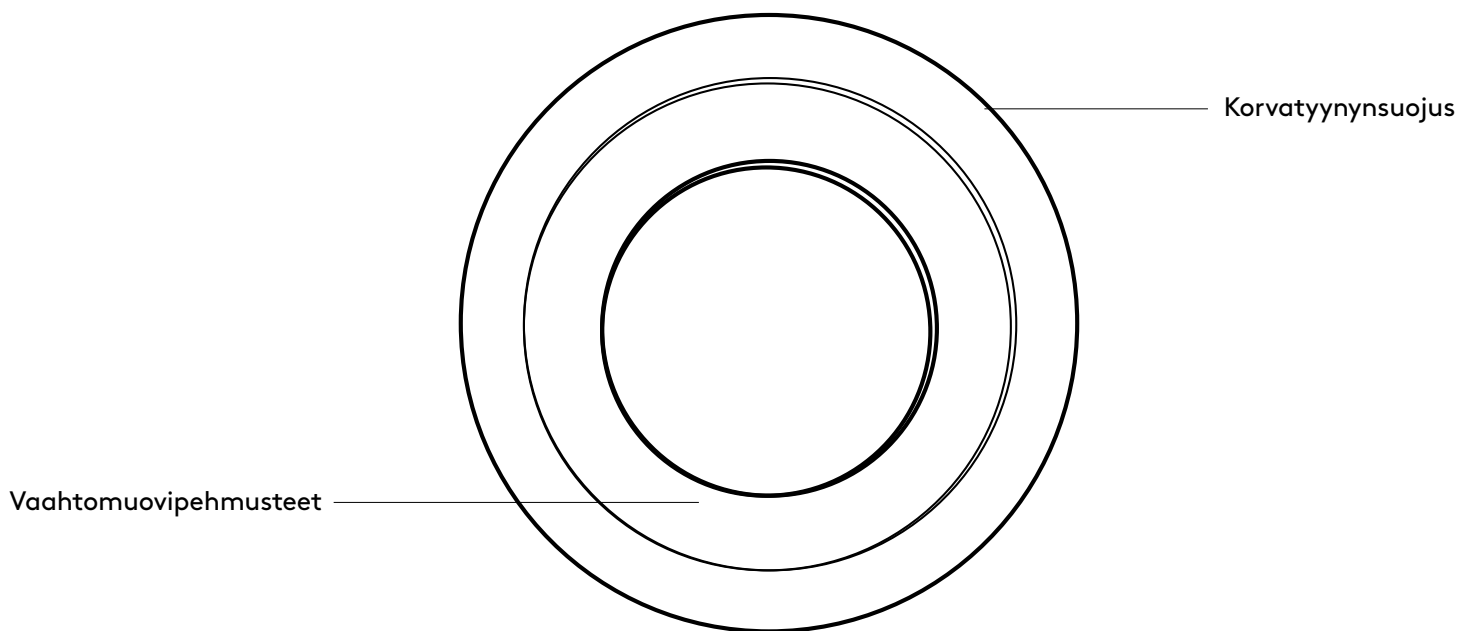

PAKKAUKSEN SISÄLTÖ

1. 1 pari (2 kpl) vaihdettavia korvatyynynsuojuksia
2. 1 pari (2 kpl) vaahtomuovipehmusteita
3. 1 pari (2 kpl) teippipari

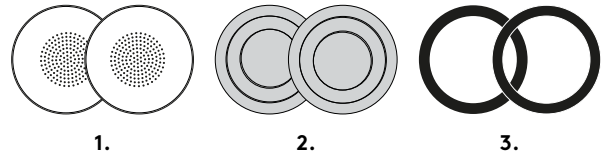

KORVATYYNYN SUOJUSTEN VAIHTAMINEN

1. Irrota korvatyynynsuojus puristamalla suojusta varovasti.

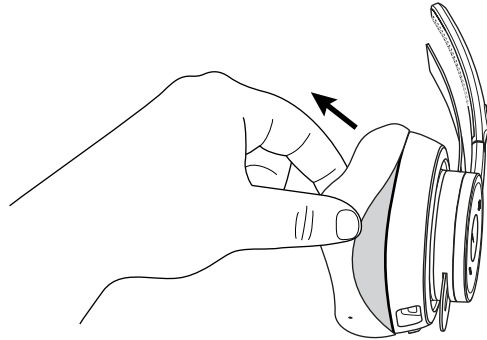

2. Vedä korvatyynynsuojusta hitaasti, kunnes se on kokonaan irti.

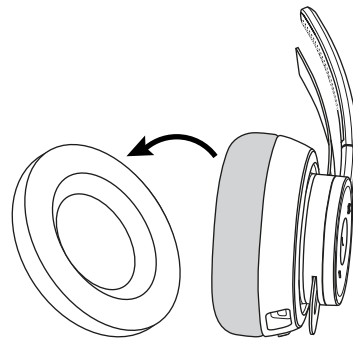

Varmista, ettet purista helposti vaurioituvaa vaahtomuovipehmustetta.

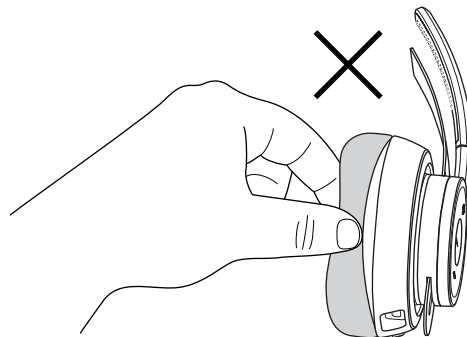

3. Jos pehmuste vaurioituu, noudata alla olevia ohjeita.

a. Irrota pehmuste kokonaan vetämällä ja vaihda uuteen.

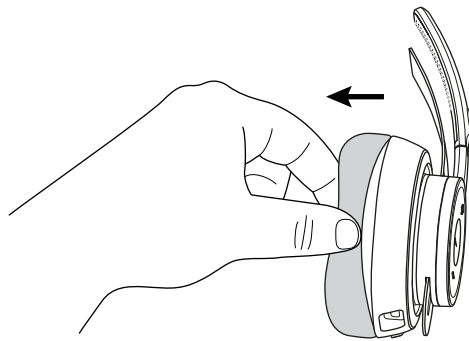

b. Kiinnitä teippi ensin korvakupin yläosaan.

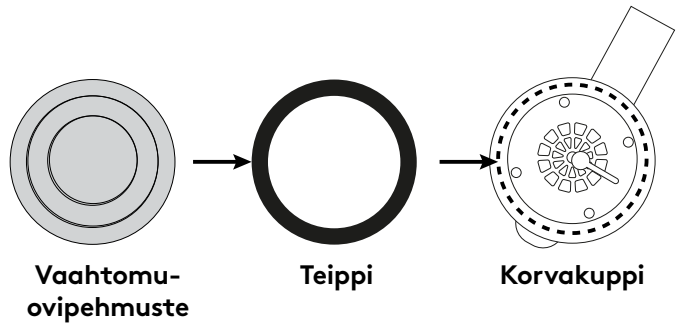

c. Kiinnitä sitten vaahtomuovipehmuste teippiin.

4. Tartu uuteen korvatyynynsuojukseen ja kohdista sivussa olevat pienet reiät korvakupin ylä- ja alaosiin. Reiän pitäisi osua alaosan USB-C-portin kohdalle.

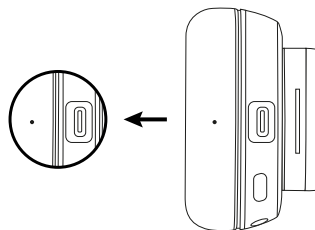

5. Pane korvatyynynsuojuksen reuna ylhäältä alkaen väliin. Työnnä suojuksen reuna korvakuppia ympäröivään väliin.

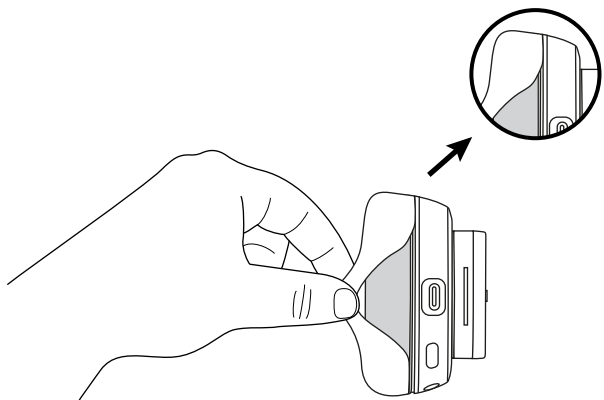

6. Kun suojus on välissä, taputtele korvakup-
pia kevyesti, jotta ilma työntyy ulos.

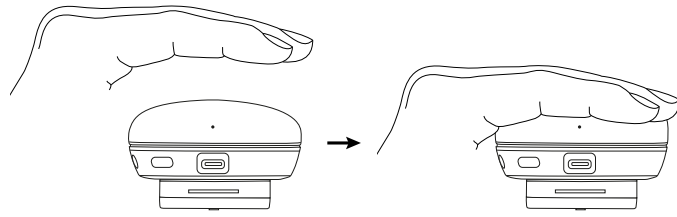

MITAT

KORVATYYNYNSUOJUKSET:

Korkeus x leveys x syvyys: 70,7 x 70,7 x 16,4 mm

www.logitech.com/support/zone-wireless-earpad-covers

ΓΝΩΡΙΜΙΑ ΜΕ ΤΟ ΠΡΟΪΟΝ

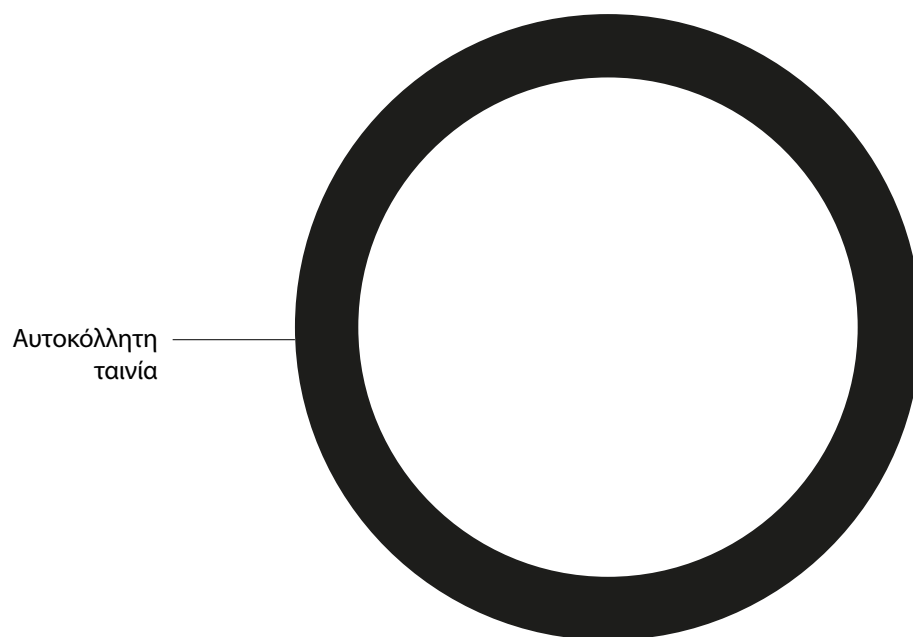
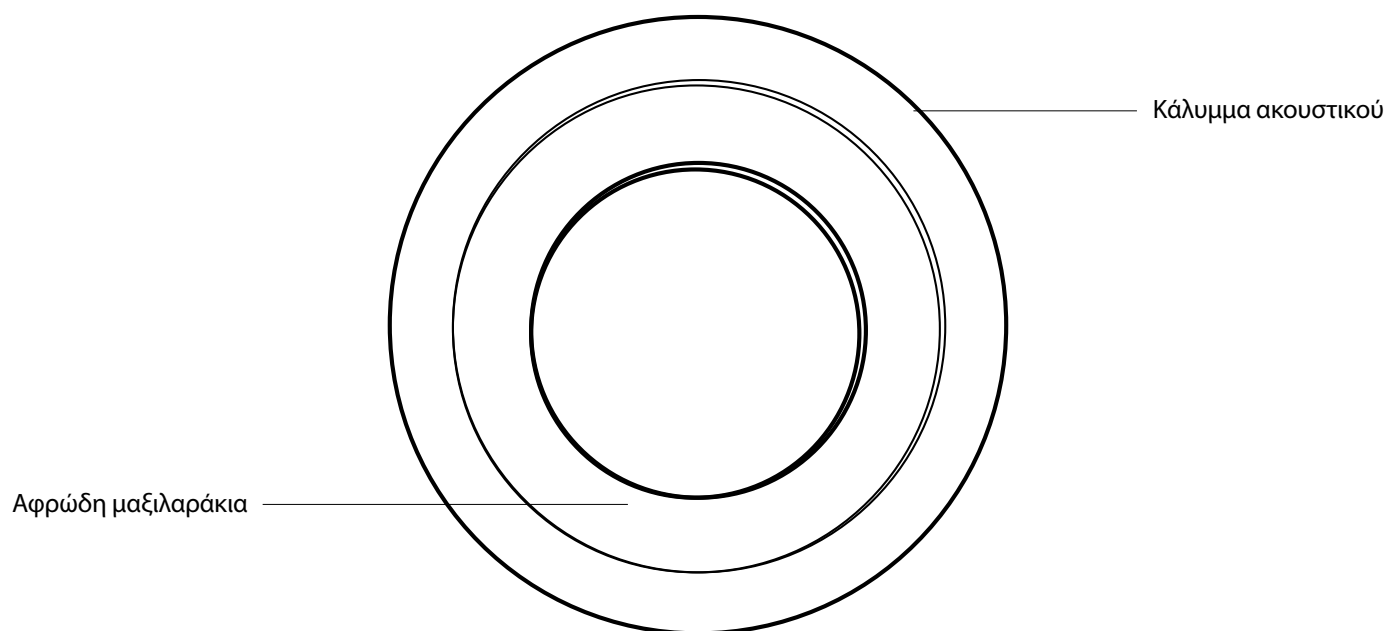

ΠΕΡΙΧΟΜΕΝΑ ΣΥΣΚΕΥΑΣΙΑΣ

1. 1 ζευγάρι (2 τεμάχια) καλυμμάτων ακουστικών με δυνατότητα αντικατάστασης
2. 1 ζευγάρι (2 τεμάχια) αφρώδη μαξιλαράκια
3. 1 ζευγάρι (2 τεμάχια) αυτοκόλλητων ταινιών

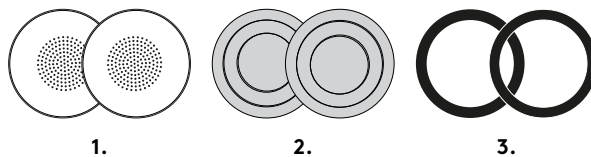

ΑΝΤΙΚΑΤΑΣΤΑΣΗ ΚΑΛΥΜΜΑΤΩΝ ΑΚΟΥΣΤΙΚΩΝ

1. Αφαιρέστε το υπάρχον κάλυμμα ακουστικού τραβώντας προσεκτικά το κάλυμμα.

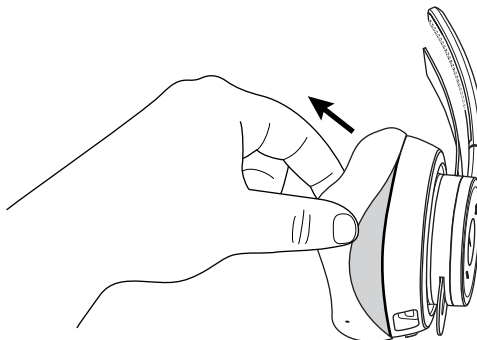

2. Τραβήξτε αργά το κάλυμμα ακουστικού μέχρι να αφαιρεθεί πλήρως.

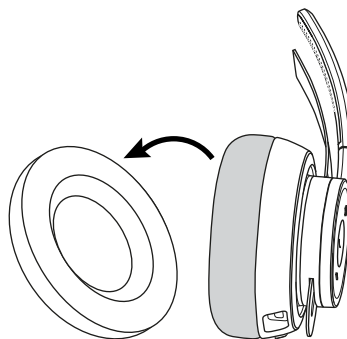

Προσέξτε να μην τραβήξετε το αφρώδες μαξιλαράκι γιατί μπορεί να καταστραφεί εύκολα.

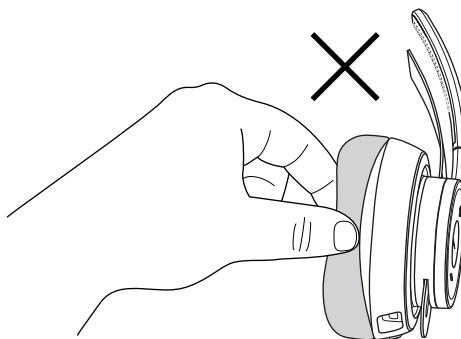

3. Εάν καταστραφεί το αφρώδες μαξιλαράκι, ακολουθήστε τα παρακάτω βήματα.

a. Αφαιρέστε το αφρώδες μαξιλαράκι και αντικαταστήστε το με νέο.

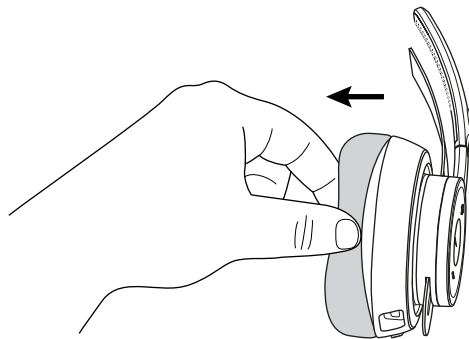

b. Τοποθετήστε πρώτα την ταινία πάνω από το ακουστικό.

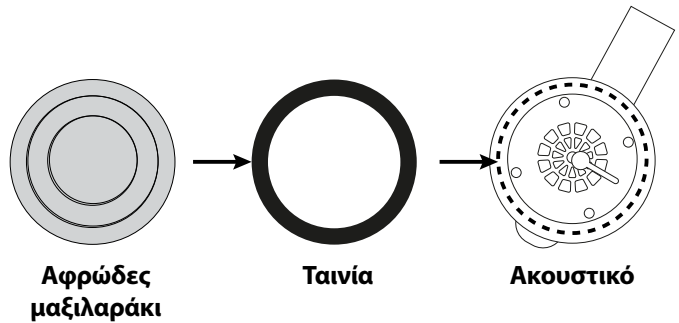

c. Στη συνέχεια, κολλήστε το αφρώδες μαξιλαράκι στην ταινία.

4. Κρατήστε το νέο κάλυμμα ακουστικού και βεβαιωθείτε ότι οι μικρές οπές στο πλάι ευθυγραμμίζονται με το επάνω και το κάτω μέρος του ακουστικού. Θα πρέπει να ευθυγραμμίζεται με τη θύρα USB C.

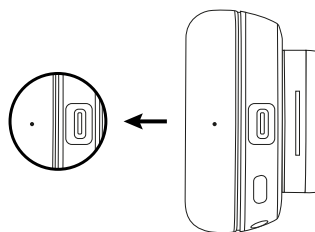

5. Ξεκινώντας από το επάνω μέρος, τοποθετήστε την άκρη του καλύμματος ακουστικού μέσα στο κενό. Τοποθετήστε την άκρη του καλύμματος στο κενό γύρω από το σώμα του ακουστικού.

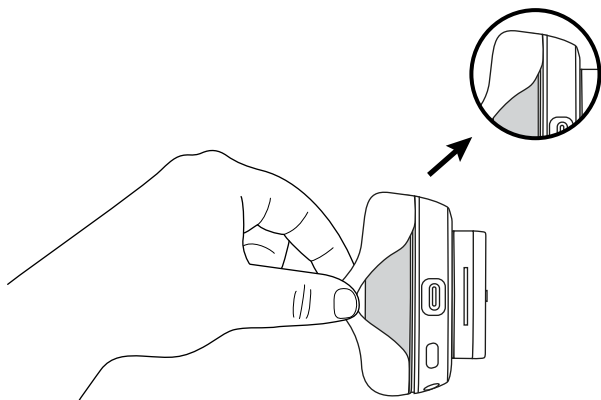

6. Αφού ολοκληρώσετε τη διαδικασία, χτυπήστε ελαφρά το ακουστικό για να φύγει ο αέρας που έχει παγιδευτεί.

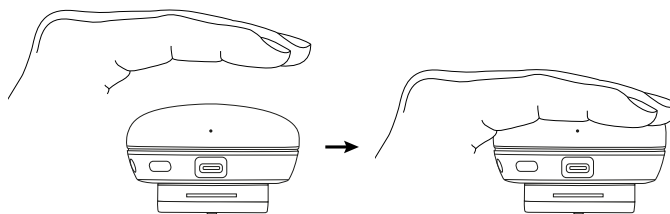

ΔΙΑΣΤΑΣΕΙΣ

ΚΑΛΥΜΜΑΤΑ ΑΚΟΥΣΤΙΚΩΝ:

Ύψος x Πλάτος x Βάθος: 70,7 mm x 70,7 mm x 16,4 mm

www.logitech.com/support/zone-wireless-earpad-covers

ЗНАКОМСТВО С ПРОДУКТОМ

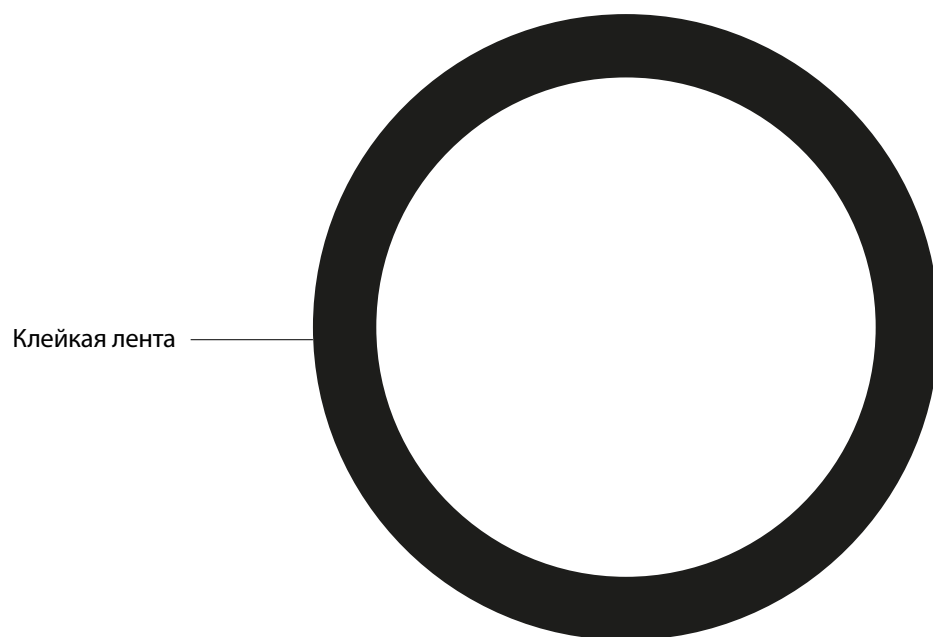
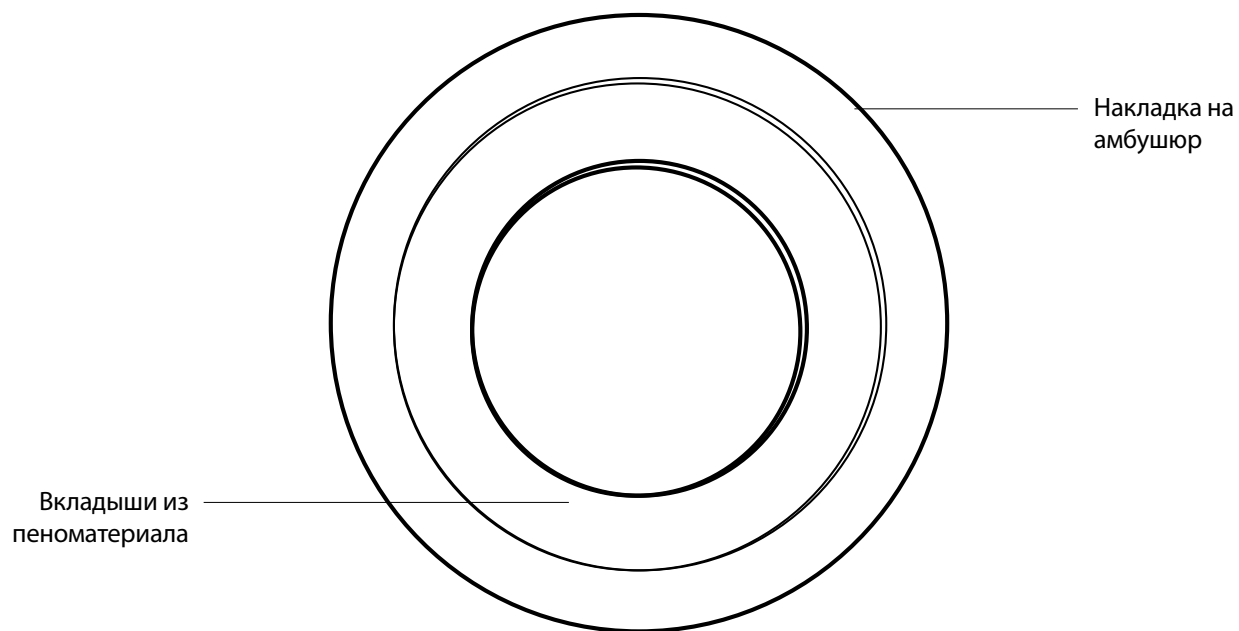

КОМПЛЕКТ ПОСТАВКИ

1. 1 пара (2 шт.) сменных накладок на амбушюры
2. 1 пара (2 шт.) вкладышей из пеноматериала
3. 1 пара (2 шт.) ленты

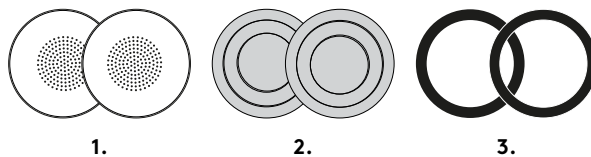

ЗАМЕНА НАКЛАДОК НА АМБУШЮРЫ

1. Снимите накладку с амбушюра, аккуратно ее поддев.

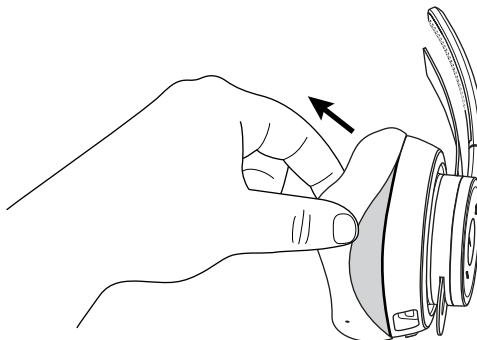

2. Медленно отделите накладку от амбушюра.

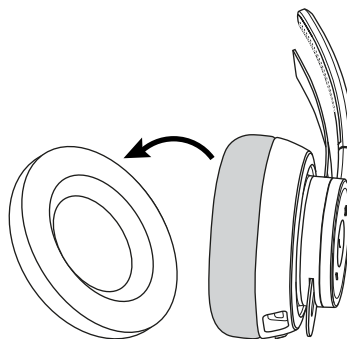

Поддевайте накладку осторожно, чтобы не задеть и не повредить вкладыш из пеноматериала.

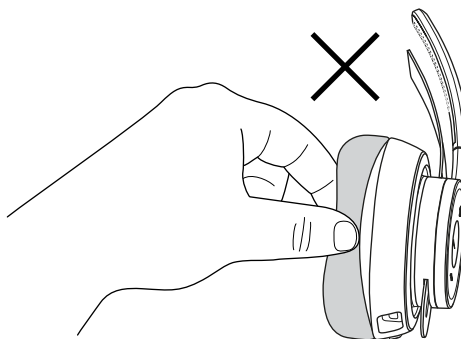

3. Если вкладыш из пеноматериала будет поврежден, выполните инструкции, приведенные ниже.
- Замените вкладыш из пеноматериала новым.

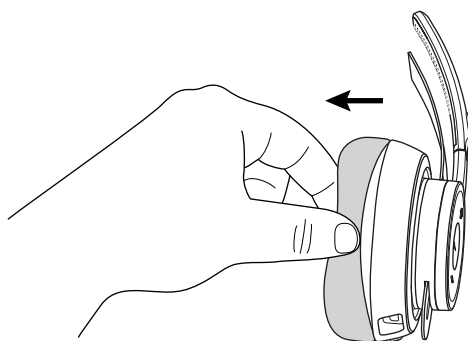

- Сначала проложите клейкую ленту на поверхности чашки наушника.

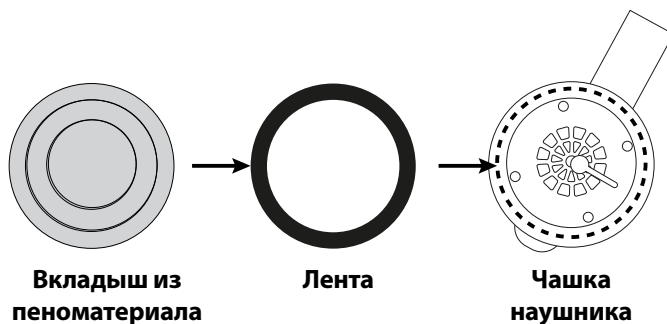

- Прикрепите к ленте вкладыш из пеноматериала.

4. Возьмите новую накладку для амбушюра так, чтобы небольшие отверстия на боковой части совпадали с верхней и нижней частями чашки наушника. Накладка должна совпадать с портом USB-C в нижней части.

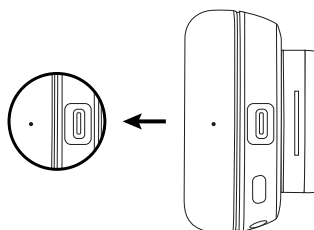

5. Вставьте край наклейки на амбушюр в специальную выемку, начиная сверху. Поместите край наклейки в выемку, которая проходит вокруг наушника.

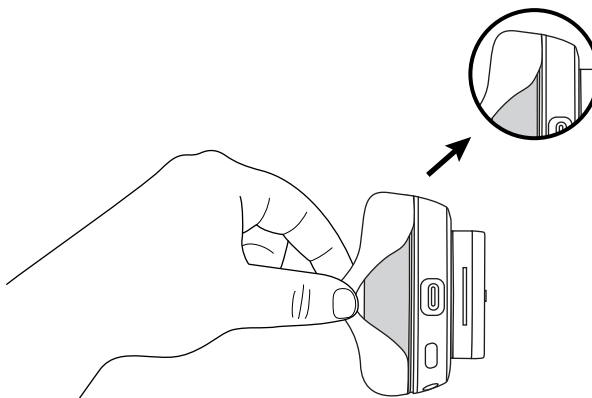

6. После этого слегка похлопайте по накладке несколько раз, чтобы удалить воздух.

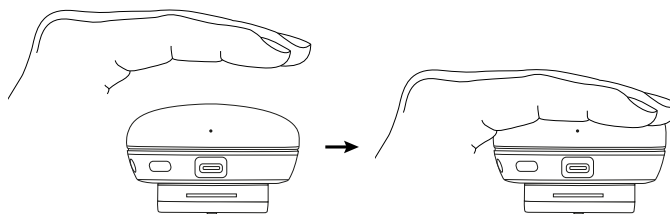

РАЗМЕРЫ

НАКЛАДКИ НА АМБУШЮРЫ

Длина x ширина x толщина: 70,7 мм x 70,7 мм x 16,4 мм

www.logitech.com/support/zone-wireless-earpad-covers

OPIS URZĄDZENIA

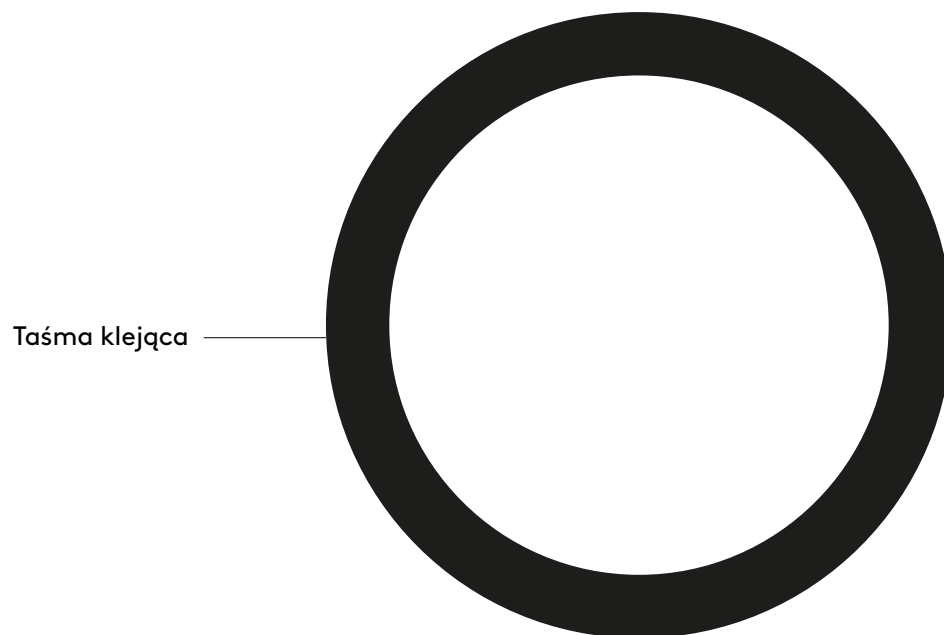
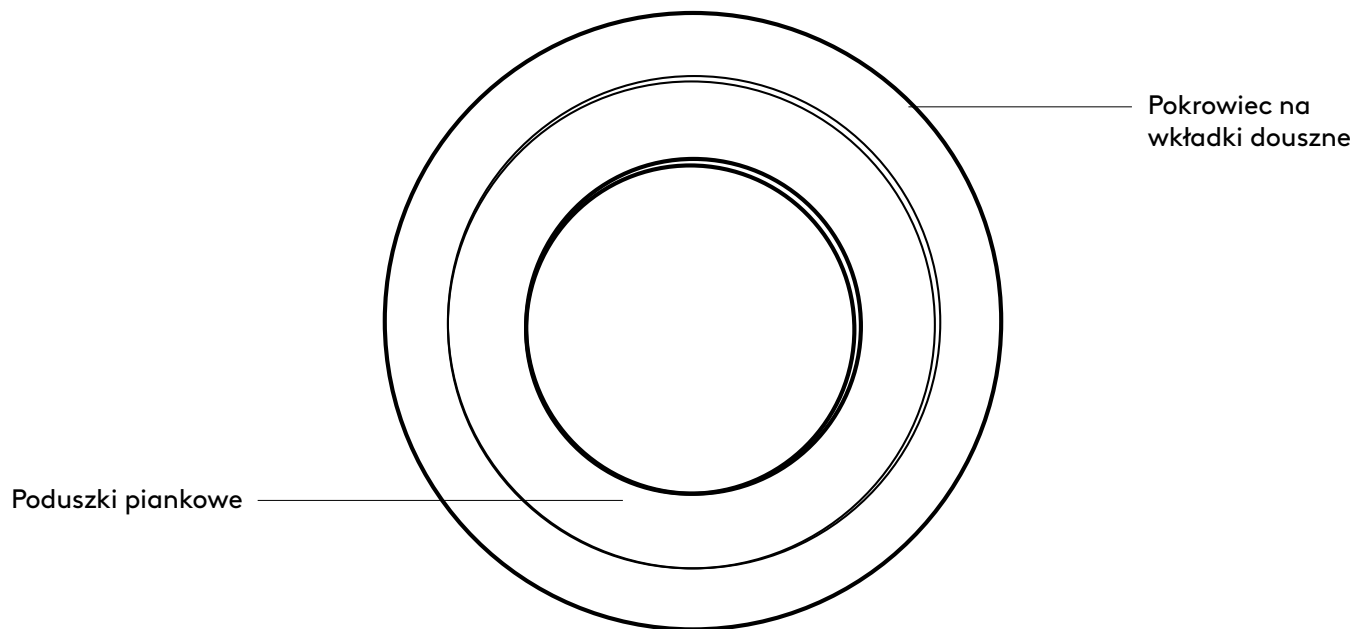

ZAWARTOŚĆ ZESTAWU

1. 1 para (2 szt.) pokrowców na wymienne wkładki douszne
2. 1 para (2 szt.) poduszek piankowych
3. 1 para (2 szt.) kawałków taśmy klejącej

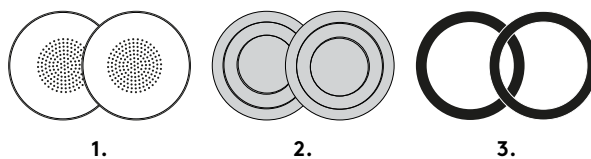

WYMIANA POKROWCÓW NA WKŁADKI DOUSZNE

1. Zdejmij założony pokrowiec na wkładkę douszną ostrożnie go ściskając.

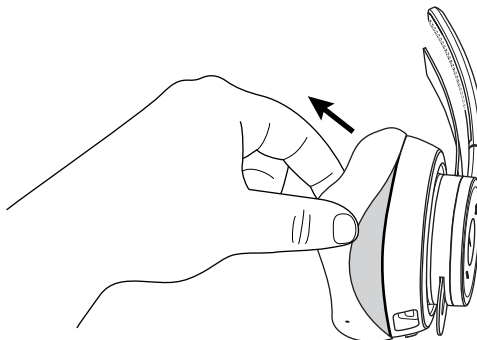

2. Zdejmuj pokrowiec na wkładkę douszną powoli, aż zostanie całkowicie zdjęty.

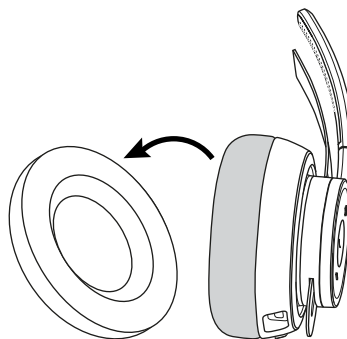

Uważaj, aby nie przyciskać poduszki piankowej, która może łatwo ulec uszkodzeniu.

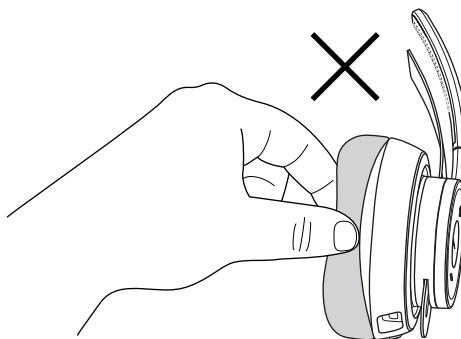

3. Jeżeli poduszka piankowa jest uszkodzona, wykonaj poniższe czynności.

a. Oderwij poduszkę piankową i wymień na nową.

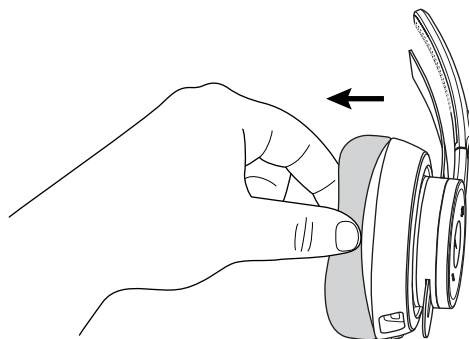

b. Umieść najpierw kawałek taśmy klejącej w górnej części nauszника.

c. Następnie przyczep poduszkę piankową do taśmy.

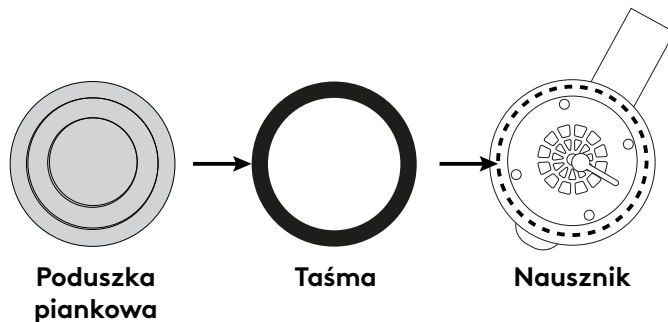

4. Chwyć nowy pokrowiec na wkładkę douszną upewniając się, że małe otwory z boku są wyrównane z górną i dolną częścią nauszника. Pokrowiec powinien być wyrównany względem portu USB C na dole.

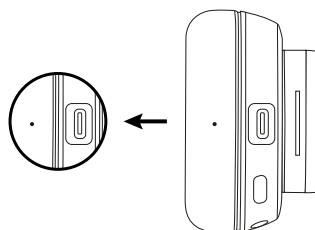

5. Rozpoczynając od góry, wsuń w szczelinę krawędź pokrowca na wkładkę douszną. Umieść krawędź pokrowca w szczelinie dookoła słuchawki.

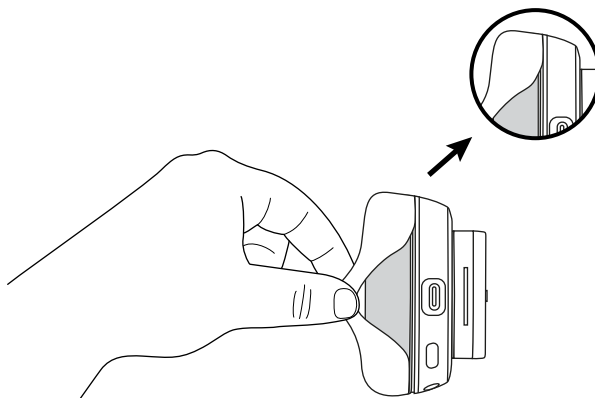

6. Po zakończeniu delikatnie uderz w nauszник kilka razy, aby usunąć powietrze.

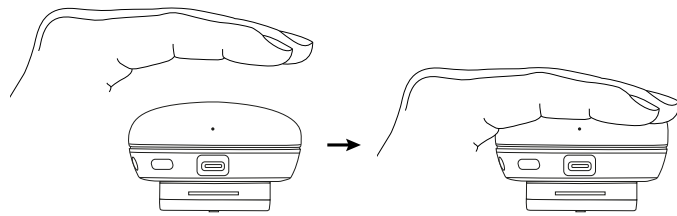

WYMIARY

POKROWCE NA WKŁADKI DOUSZNE

Wysokość x szerokość x głębokość: 70,7 mm x 70,7 mm x 16,4 mm

www.logitech.com/support/zone-wireless-earpad-covers

A TERMÉK ISMERTETÉSE

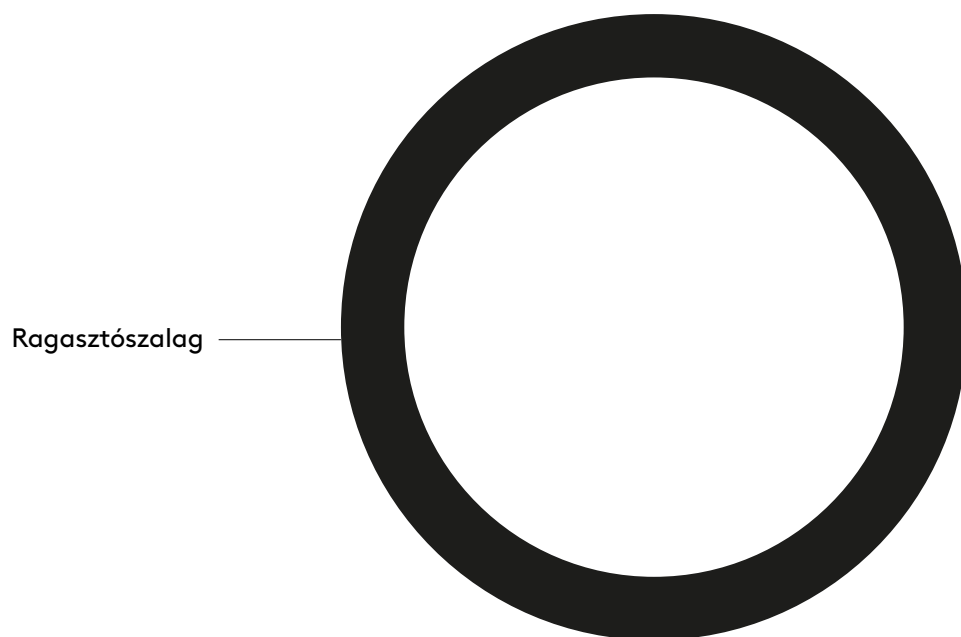
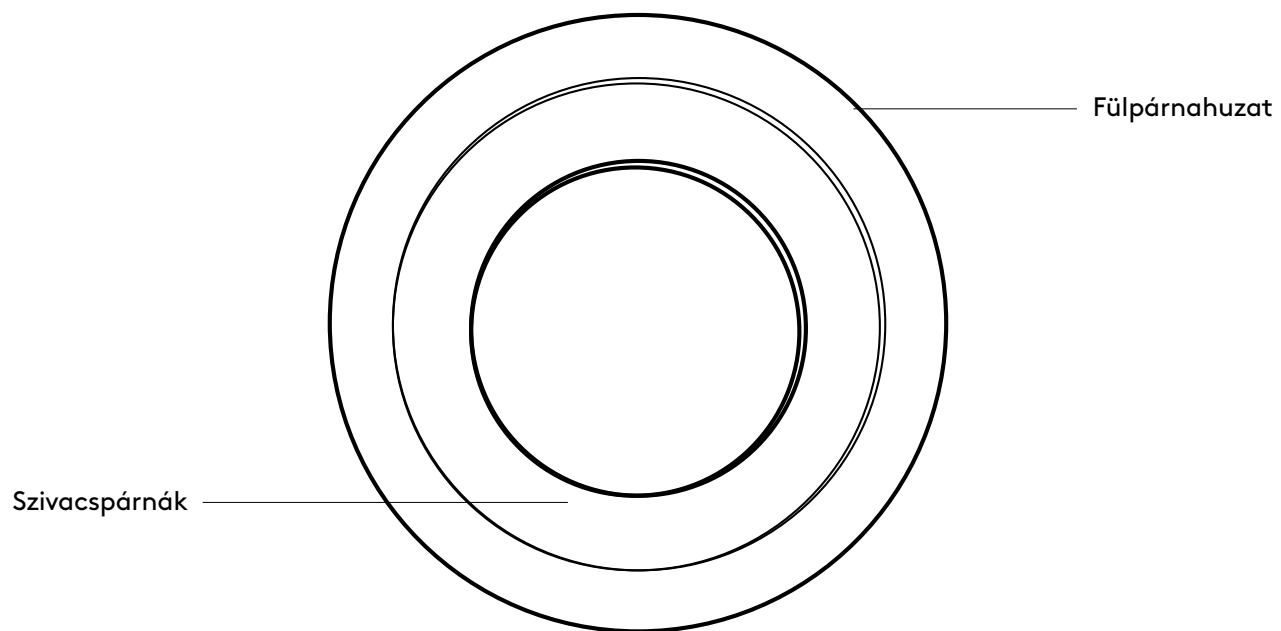

A CSOMAG TARTALMA

1. 1 pár (2 db) cserélhető fülpárnahuzat
2. 1 pár (2 db) szivacspárna
3. 1 pár (2 db) ragasztószalag

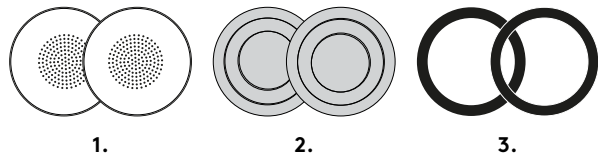

A FÜLPÁRNAHUZAT CSERÉJE

1. Fogja meg a fülhallgatón lévő fülpárnahuzatot, óvatosan megcsípve annak szélét.

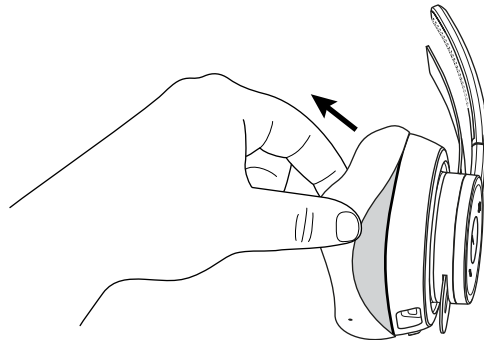

2. Lassan húzza le a fülpárnahuzatot, amíg teljesen le nem jön.

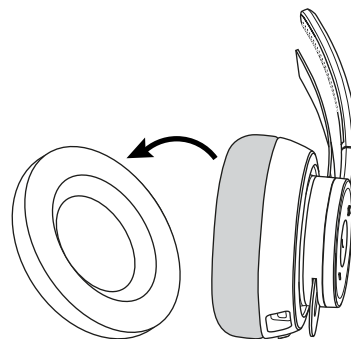

Ügyeljen, hogy a szivacspárnát ne fogja hozzá, mert az hajlamos könnyen megsérülni.

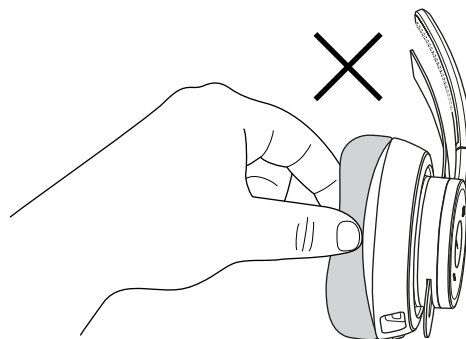

3. Ha a szivacspárna megsérült, kövesse az alábbi lépéseket.

a. Fejtsse le a szivacspárnát, és cserélje ki újra.

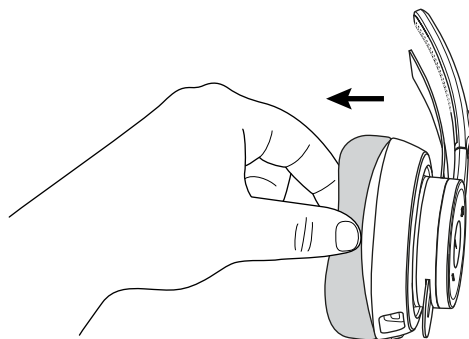

b. Helyezze a ragasztószalagot előbb a fülhallgató felső részére.



c. Ezután rögzítse a szivacspárnát a ragasztószalaghoz.

4. Fogja meg az új fülpárnahuzatot, ügyelve arra, hogy a kis lyukak az oldalán egybeessenek a fülhallgató tetejével, illetve aljával. A lyuknak egybe kell esnie alul az USB-C porttal is.

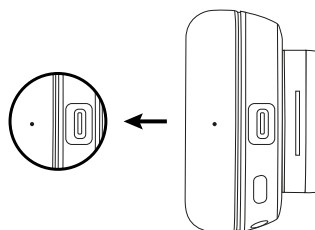

5. Fentről kezdve nyomja be a fülpárnahuzat szélét a horonyba. Illessze be a fülpárnahuzat szélét a fülhallgatón körbefutó horonyba.

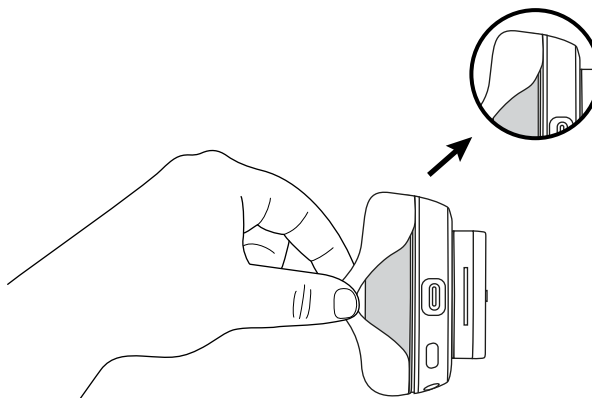

6. Miután végzett, óvatosan ütögesse meg néhányszor a fülhallgatót, hogy kinyomja belőle a levegőt.

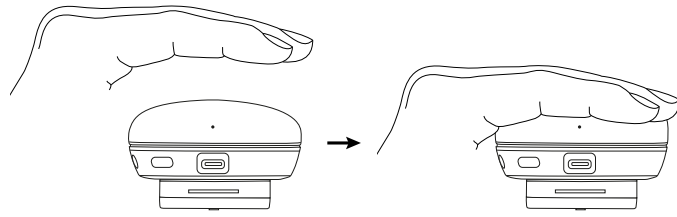

MÉRETEK

FÜLPÁRNAHUZAT:

Magasság x szélesség x mélység: 70,7 mm x 70,7 mm x 16,4mm

www.logitech.com/support/zone-wireless-earpad-covers

POPIS PRODUKTU

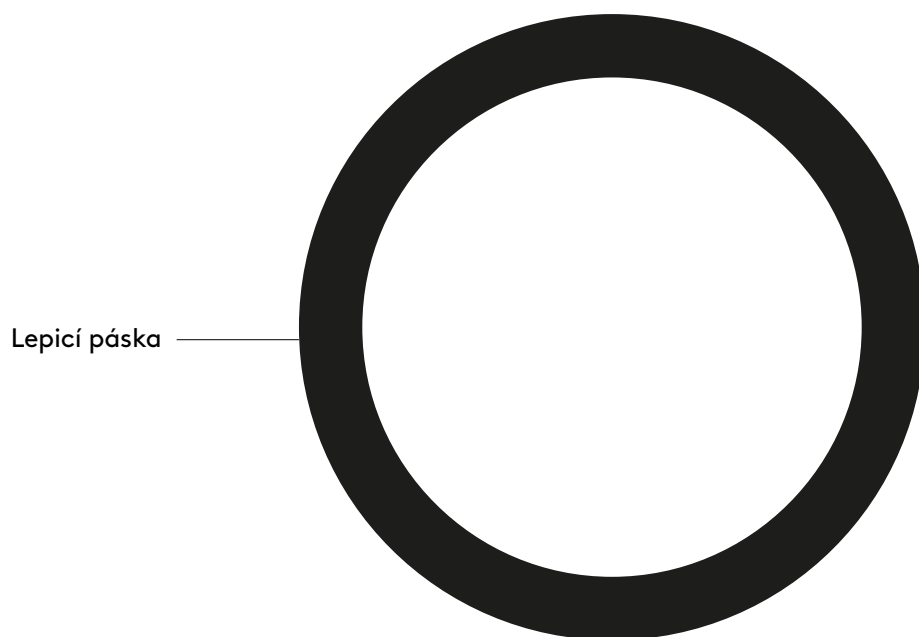
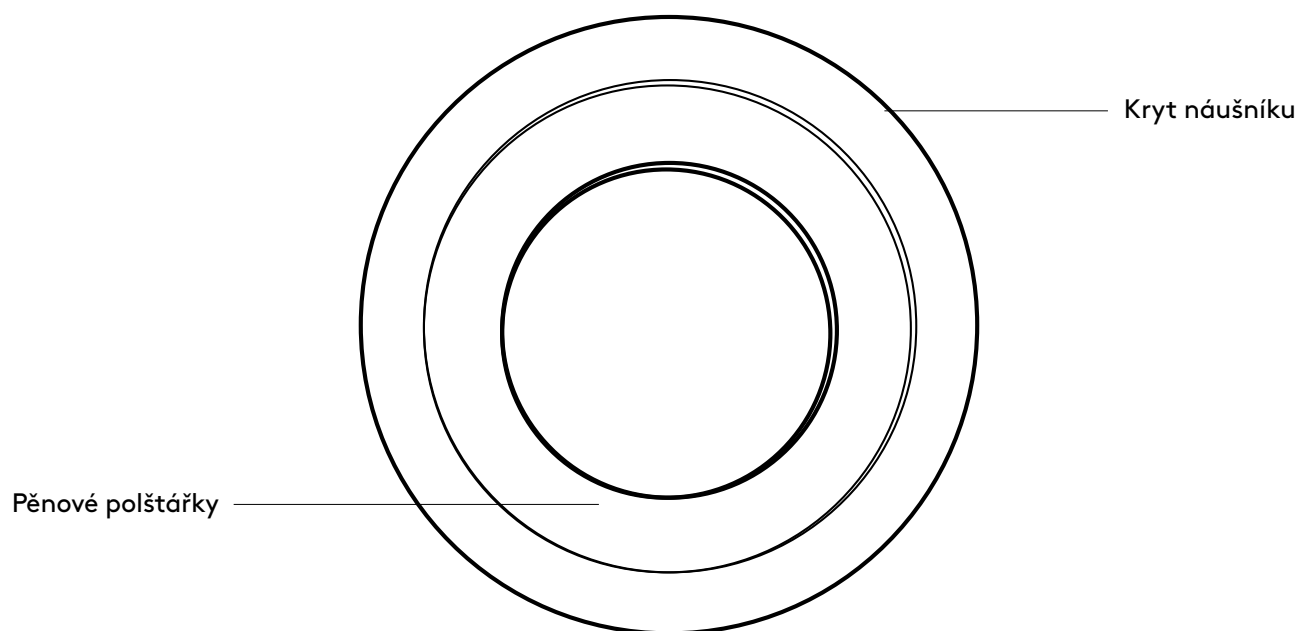

OBSAH BALENÍ

1. 1 pár (2 ks) výměnných krytů náušníků
2. 1 pár (2 ks) pěnových polštářků
3. 1 pár (2 ks) lepicích pásek

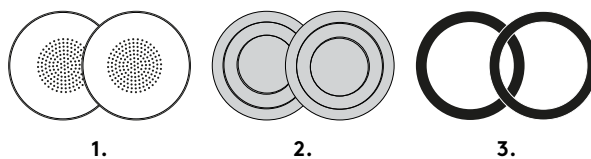

VÝMĚNA KRYTŮ NÁUŠNÍKŮ

1. Stávající kryt náušníku opatrně sejměte tím, že jej zmáčknete.

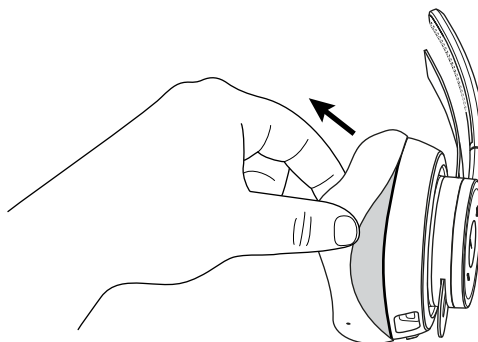

2. Pomalu táhněte za kryt náušníku, dokud jej zcela nesejmete.

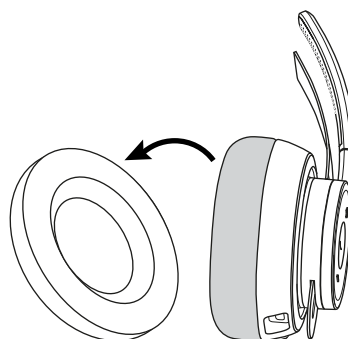

Dbejte na to, abyste nemačkali pěnový polštářek, který se snadno poškodí.

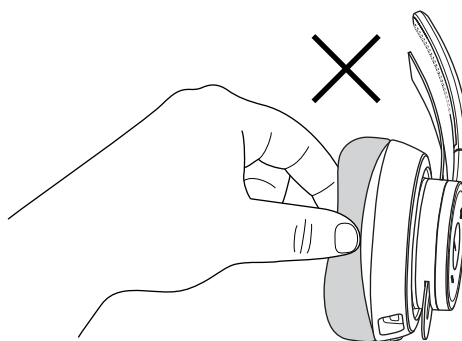

3. V případě poškození pěnového polštářku postupujte podle pokynů níže.
- a. Odlepte pěnový polštářek a vyměňte je za nový.

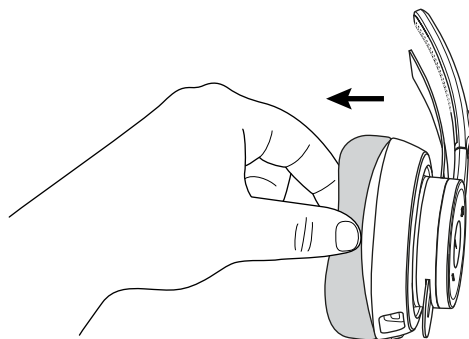

- b. Nejprve nalepte pásku na vršek náušníku.

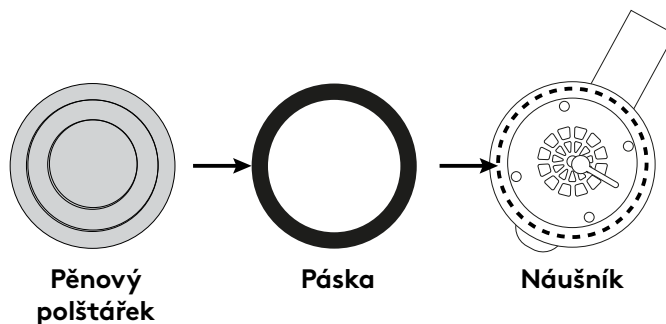

- c. Poté nalepte pěnový polštářek k pásce.

4. Uchopte nový kryt náušníku, přičemž dbejte na to, aby se malé otvory na boku vyrovnaly s vrškem a spodkem náušníku. Měly by se vyrovnat s portem USB C ve spodní části.

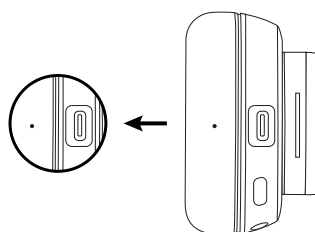

5. Začněte od vršku a vložte okraj krytu náušníku do otvoru. Vložte okraj krytu do otvoru po celém obvodu.

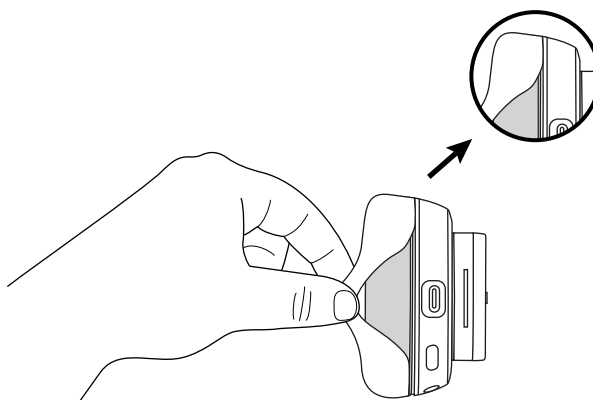

6. Po dokončení jemně několikrát přejeďte po náušníku, čímž vytlačíte zbylý vzduch.

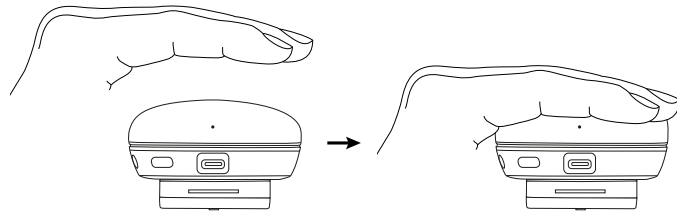

ROZMĚRY

KRYTY NÁUŠNÍKŮ:

Výška x šířka x hloubka: 70,7 mm x 70,7 mm x 16,4 mm

www.logitech.com/support/zone-wireless-earpad-covers

SPOZNAJTE IZDELEK

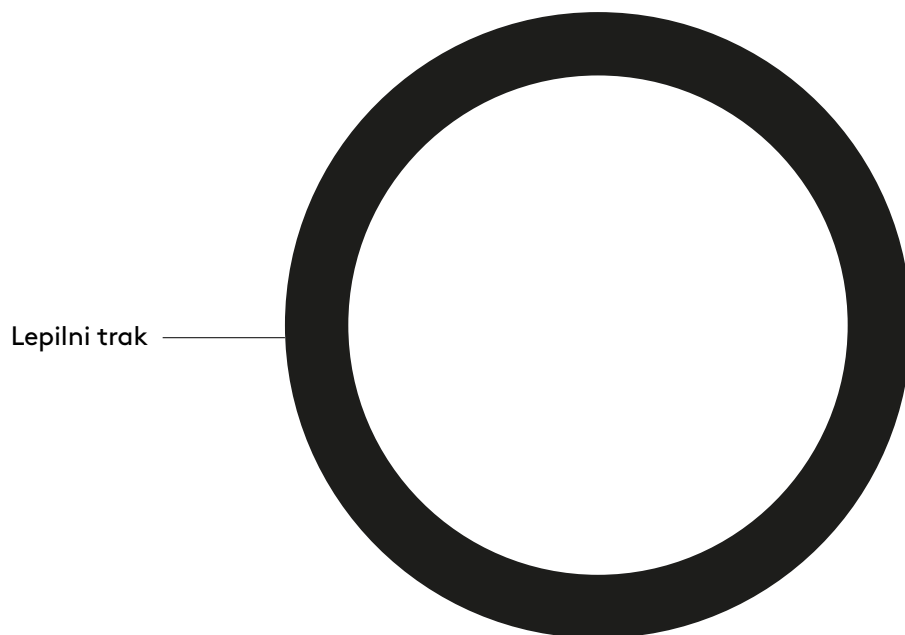
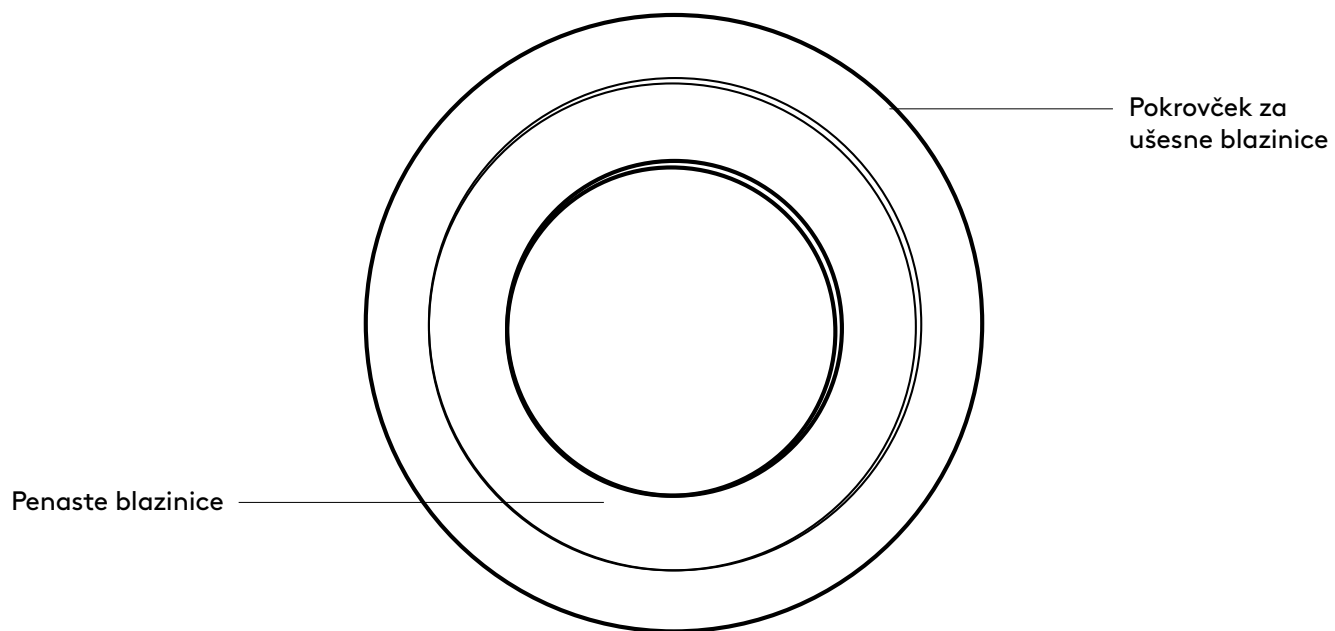

VSEBINA PAKETA

1. 1 par (2 kosa) zamenljivih pokrovčkov za ušesne blazinice
2. 1 par (2 kosa) penastih blazinic
3. 1 par (2 kosa) lepilnih trakov

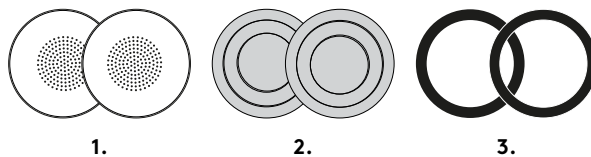

ZAMENJAVA POKROVČKOV ZA UŠESNE BLAZINICE

1. Stari pokrovček za ušesno blazinico snemite, tako da ga previdno priščipnete.

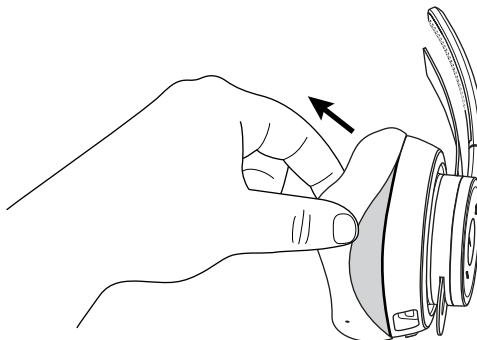

2. Pokrovček odstranjajte počasi, dokler ga v celoti ne snamete.

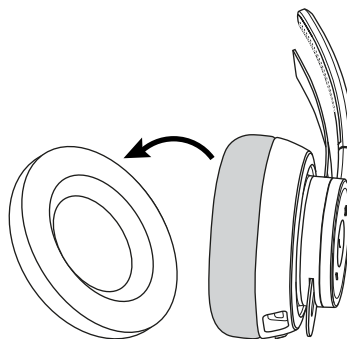

Pazite, da ne priščipnete penasto blazinico, ki se lahko hitro poškoduje.

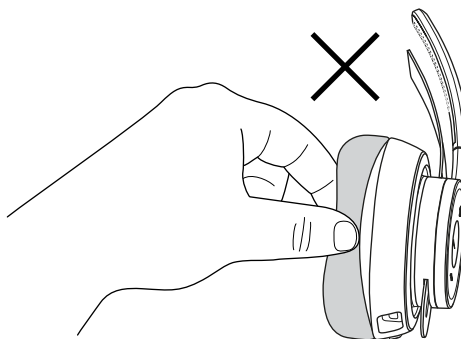

3. Če se penasta blazinica poškoduje, sledite korakom v nadaljevanju.
- Odlepите penasto blazinico in namestite novo.

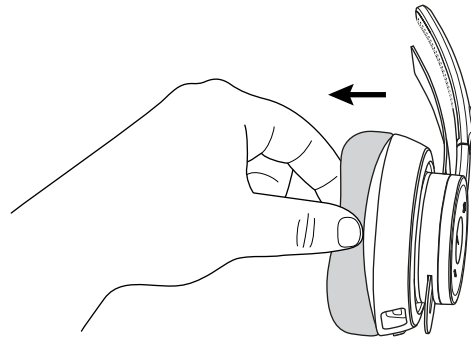

- Najprej na slušalko zalepite lepilni trak.

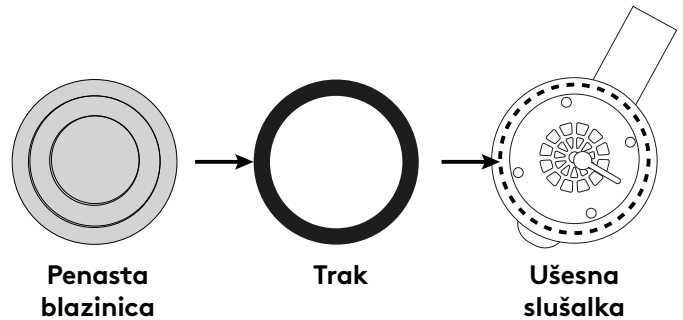

- Nato na lepilni trak pritrdite penasto blazinico.

4. Primite nov pokrovček za ušesno blazinico tako, da sta luknjici ob straneh poravnani z zgornjim in spodnjim delom slušalke. Na spodnjem delu mora biti luknjica poravnana z vhodom USB-C.

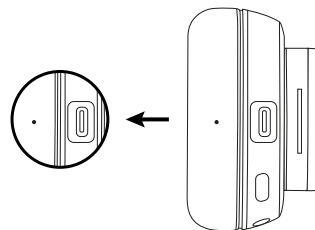

5. Rob pokrovčka vstavite v režo, tako da začnete pri vrhu slušalke. Nadaljujte z vstavljanjem v režo okrog slušalke.

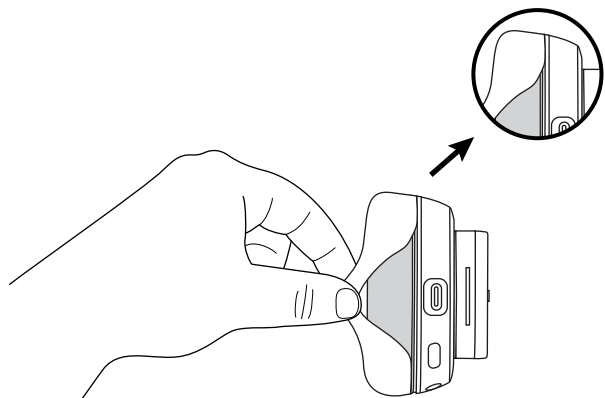

6. Ko rob pokrovčka v celoti vstavite, slušalko nekajkrat nežno pritisnite, da iztisnete zrak.

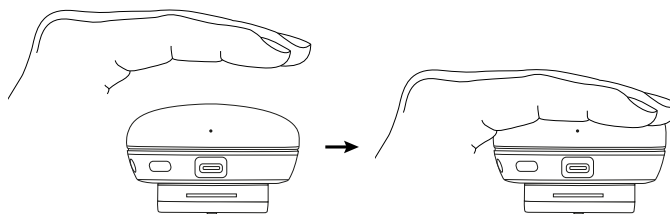

DIMENZIJE

POKROVČEK UŠESNE BLAZINICE:

Višina x širina x globina: 70,7 mm x 70,7 mm x 16,4 mm

www.logitech.com/support/zone-wireless-earpad-covers

ОЗНАЙОМЛЕННЯ З ПРИСТРОЄМ

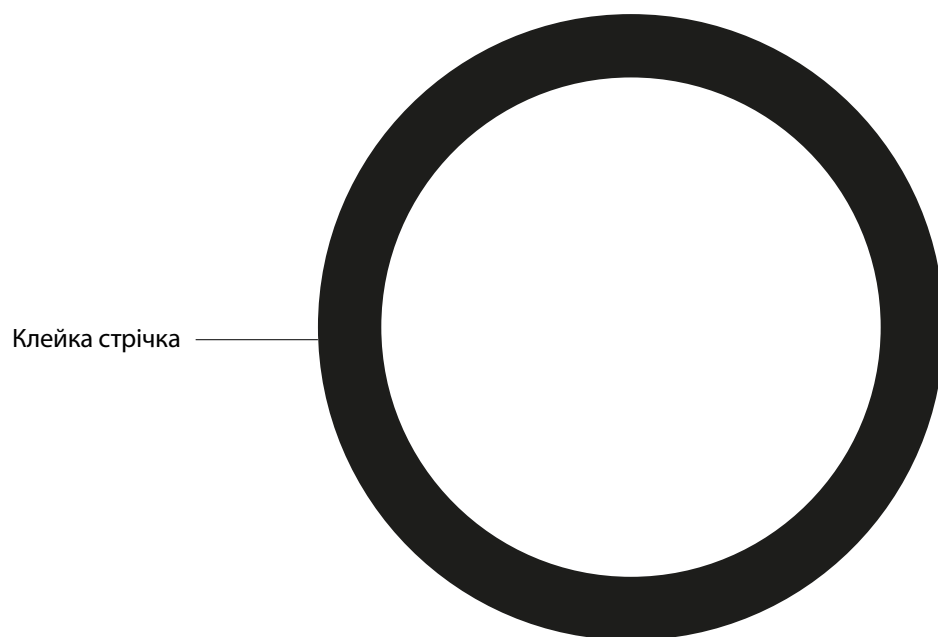
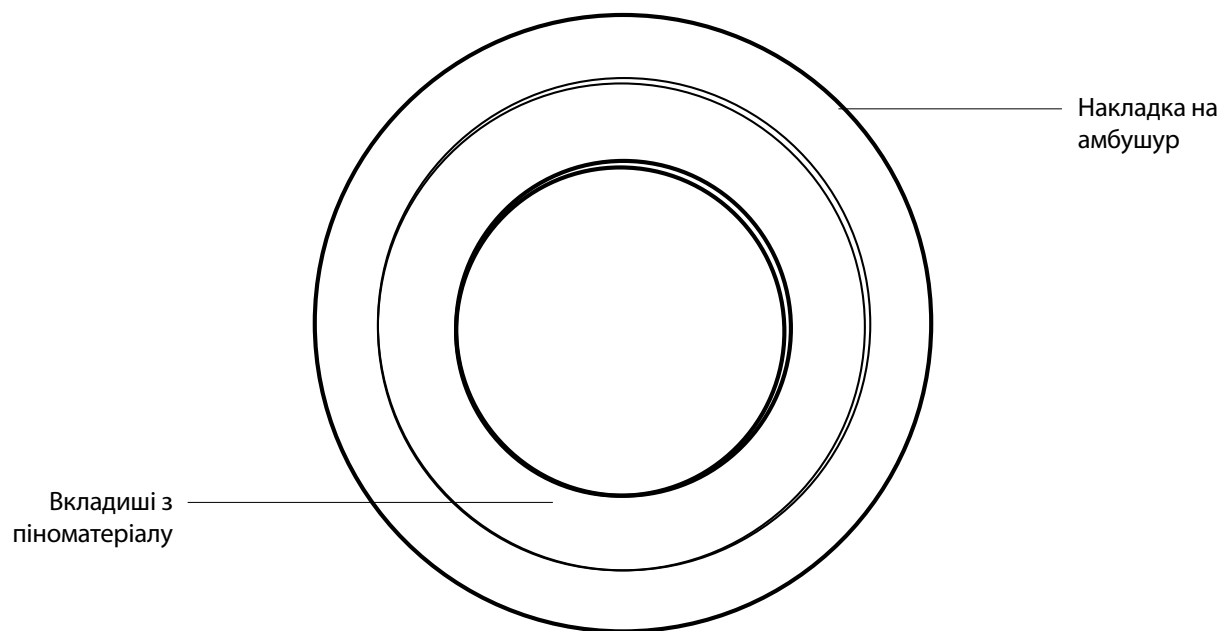

ВМІСТ УПАКОВКИ

1. 1 пара (2 шт.) змінних накладок на амбушури
2. 1 пара (2 шт.) вкладишів з піноматеріалу
3. 1 пара (2 шт.) клейкі стрічки

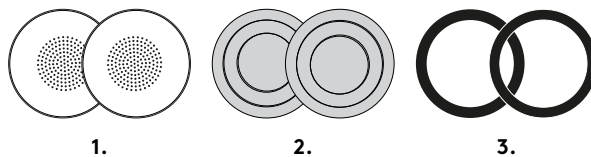

ЗАМІНЮВАННЯ НАКЛАДОК НА АМБУШУРИ

1. Зніміть накладку для амбушура, обережно її підчепивши.

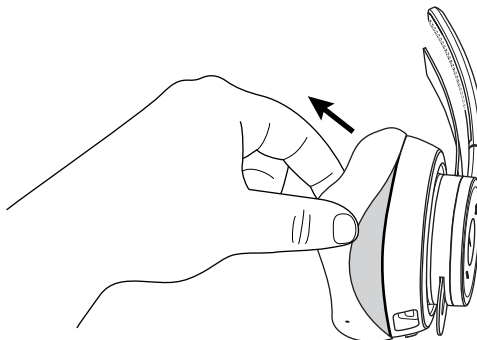

2. Повільно відділіть накладку для амбушура.

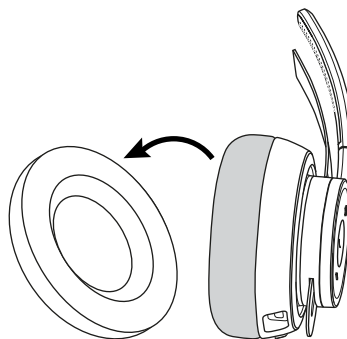

Відділяйте накладку обережно, щоб не зачепити та не пошкодити вкладиш із піноматеріалу.

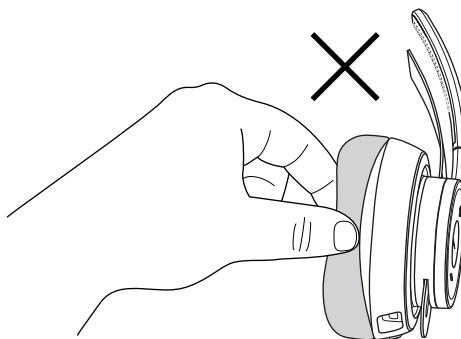

3. Якщо вкладиш буде пошкоджено, виконайте наведені нижче дії.

a. Видаліть вкладиш із піноматеріалу і замініть його новим.

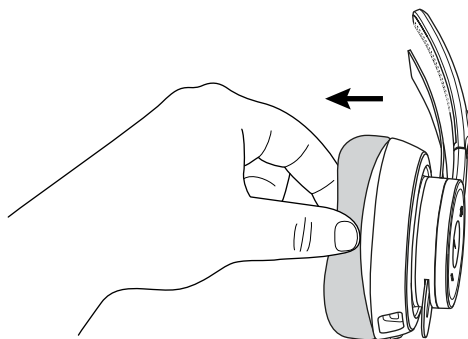

b. Спершу розташуйте на поверхні чашки навушника клейку стрічку.

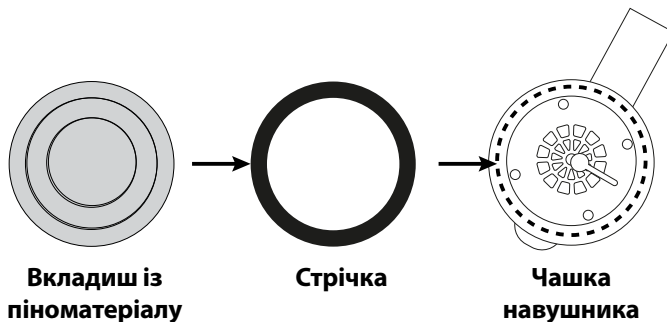

c. Потім прикріпіть вкладиш із піноматеріалу до стрічки.

4. Візьміть нову накладку для амбушура так, щоб маленькі отвори з боків збіглися з верхньою і нижньою частинами чашки навушника. Отвір на накладці повинен збігатися з відповідним отвором для порту USB-C в нижній частині навушника.

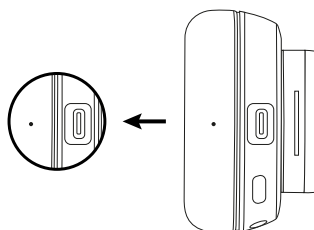

5. Вставте край накладки для амбушура в спеціальну виїмку, починаючи згори. Помістіть край накладки у виїмку навколо навушника.

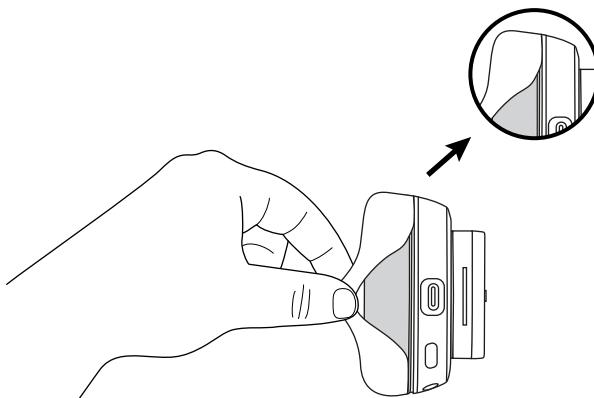

6. Коли завершите, обережно поплескайте по накладці, щоб видалити повітря.

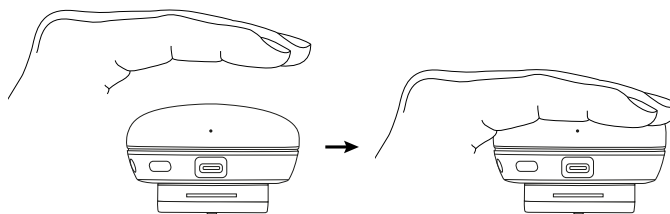

РОЗМІРИ

НАКЛАДКИ НА АМБУШУРИ

Довжина x ширина x товщина: 70,7 мм x 70,7 мм x 16,4 мм

www.logitech.com/support/zone-wireless-earpad-covers

TOOTE TUTVUSTUS

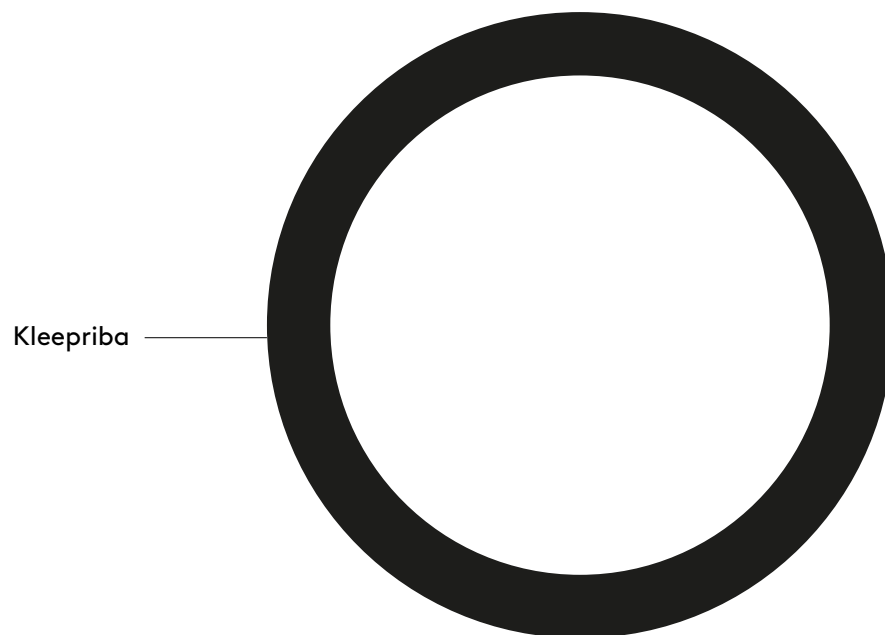
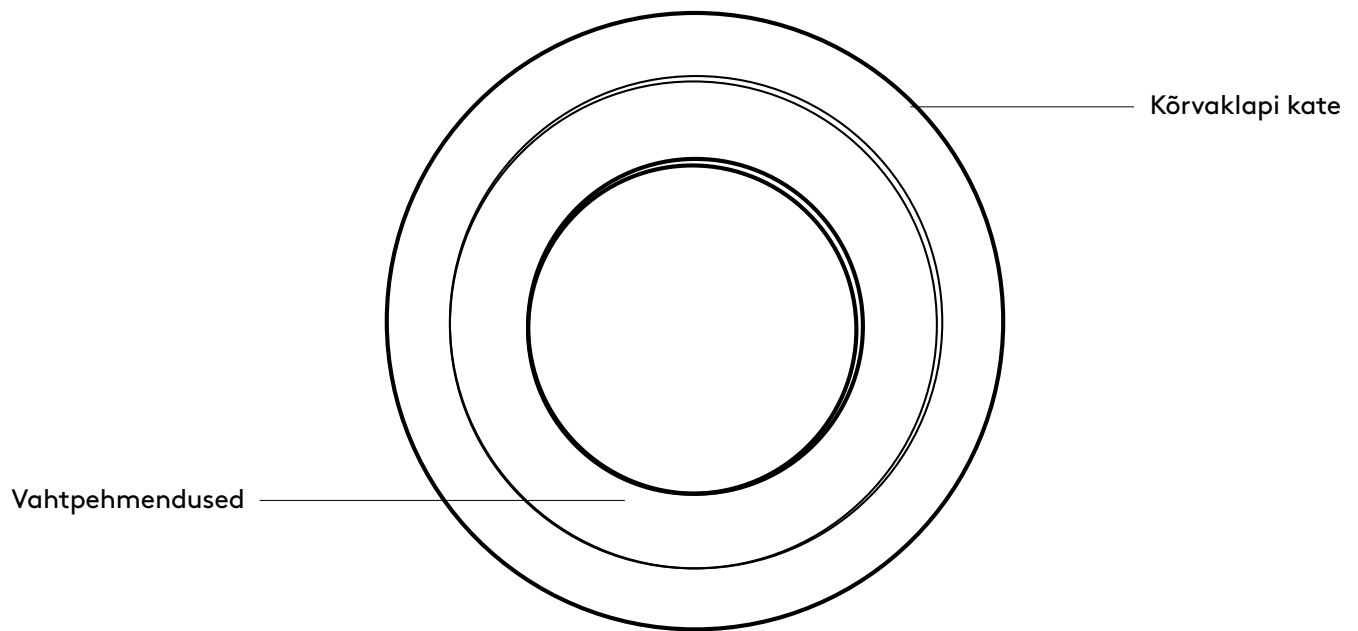

KARBI SISU

1. 1 paar (2 tk) vahetatavaid kõrvaklappide katteid
2. 1 paar (2 tk) vahtpehmendusi
3. 1 paar (2 tk) kleepriba

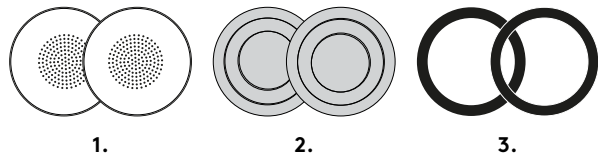

KÕRVAKLAPPIDE KATETE VAHETAMINE

1. Võtke olemasolev kõrvaklapi kate ära, pigistades katet ettevaatlikult kokku.

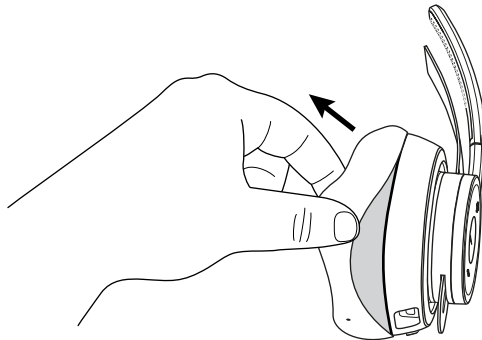

2. Eemaldage kõrvaklapi kate aeglaselt, kuni see on täielikult maas.

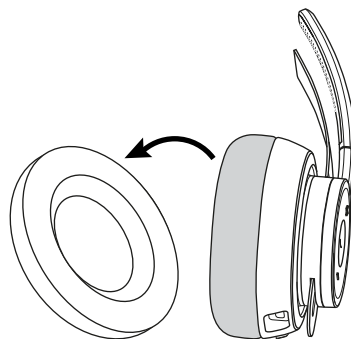

Veenduge, et te ei pigistaks vahtpehmendust kokku, sest võite neid kergesti kahjustada.

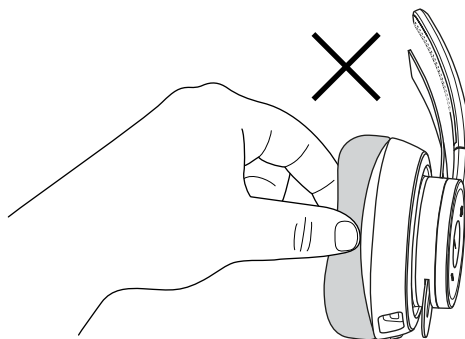

3. Kui vahtpehmendus on kahjustatud, järgige allolevaid samme.

a. Võtke vahtpehmendus ära ja asendage uuega.

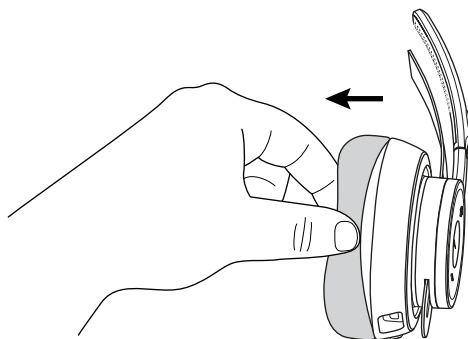

b. Paigutage kleepriba kõigepealt kõrvakaitse ülemisele osale.

c. Seejärel kinnitage vahtpehmendus kleepriba külge.

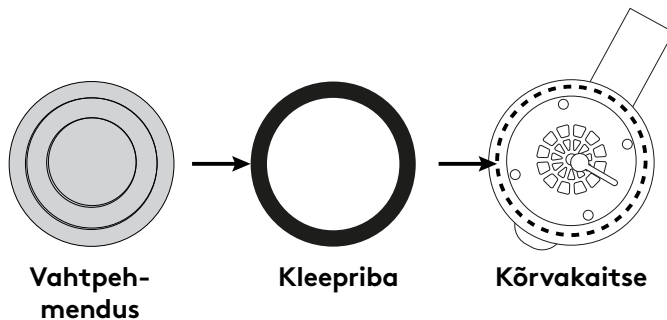

4. Haarake uuest kõrvaklapi kattest kinni, veendudes, et küljel olevad väikesed augud oleks kõrvakaitse ülemise ja alumise osaga joondatud. See peaks joonduma allääres oleva USB C-pordiga.

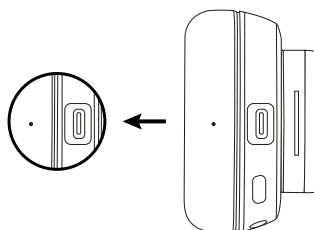

5. Alustage ülevalt ja juhtige kõrvaklapi katte serv vahesse. Pange katte serv kõrvaklapi kuulari ümber olevasse vahesse.

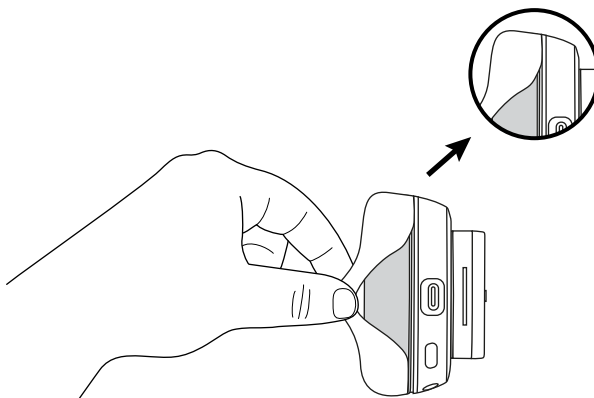

6. Pärast lõpetamist patsutage kõrvakaitset õrnalt mitu korda, et õhk välja suruda.

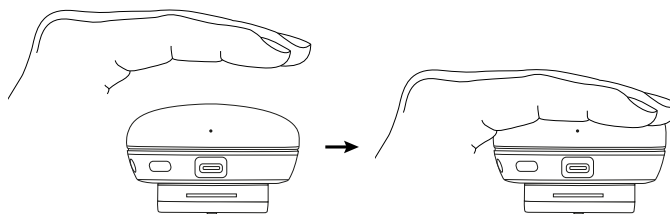

MÕÕDUD

KÕRVAKLAPPIDE KATTED:

Kõrgus x laius x sügavus: 70,7 mm x 70,7 mm x 16,4 mm

www.logitech.com/support/zone-wireless-earpad-covers

IERĪCES APRAKSTS

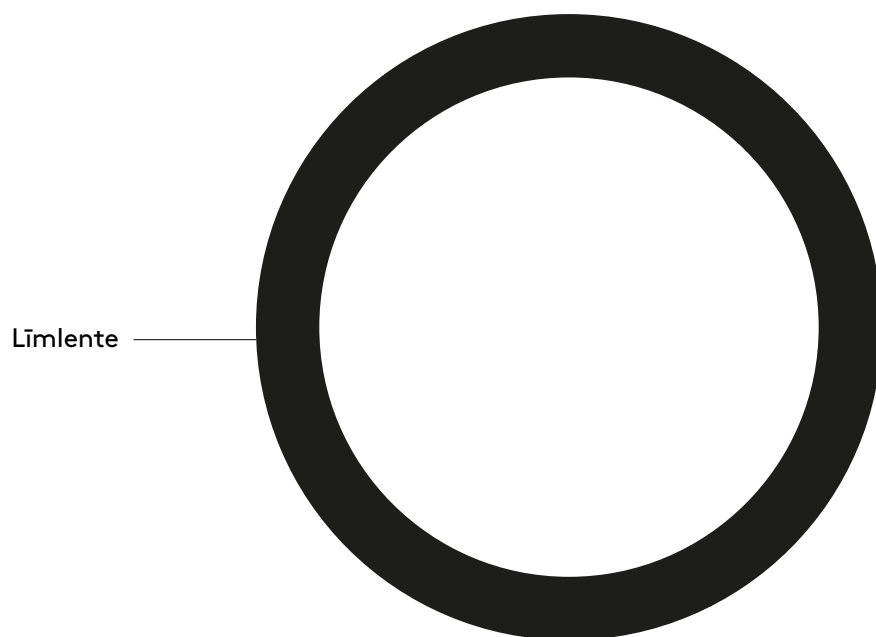
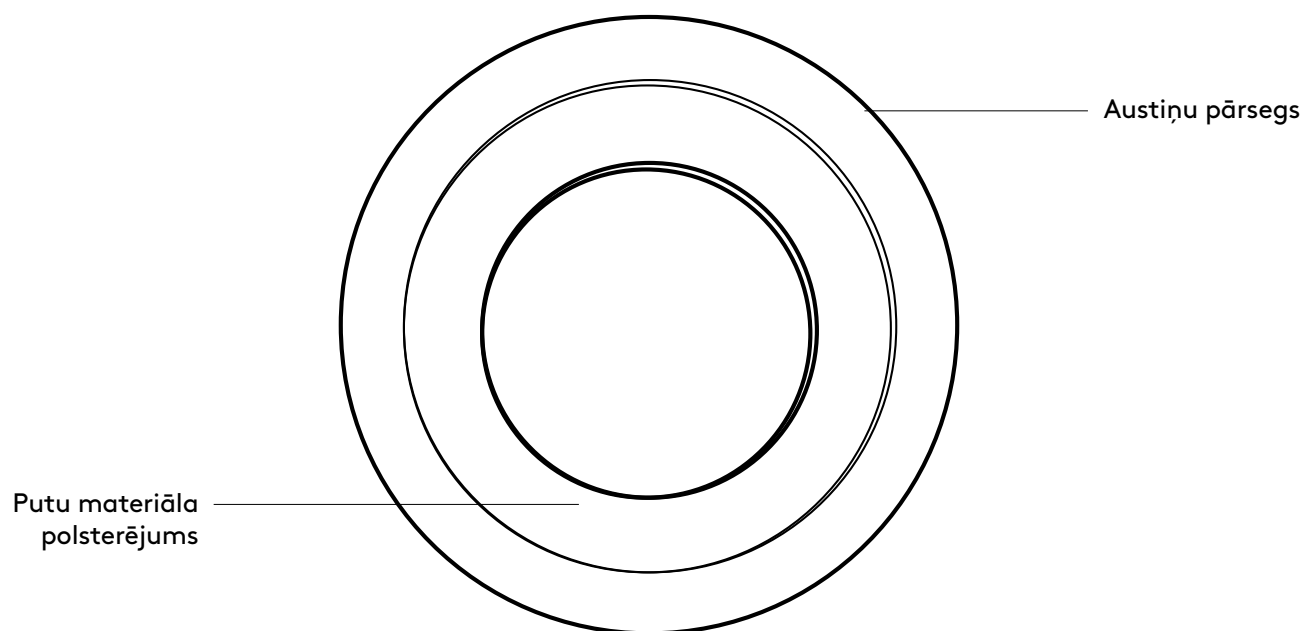

IEPAKOJUMA SATURS

1. 1 pāris (2 gab.) nomaināmu austiņu pārsegu
2. 1 pāris (2 gab.) putu materiāla polsterējuma
3. 1 pāris (2 gab.) limlentu

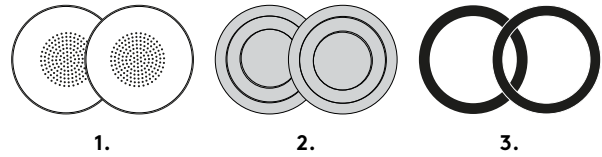

AUSTIŅU PĀRSEGU NOMAIŅA

1. Noņemiet esošo austiņu pārsegu, uzmanīgi satverot stūri.

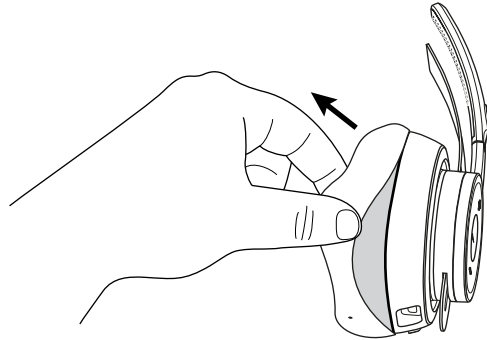

2. Lēni noņemiet austiņu pārsegu, līdz tas ir pilnībā noņemts.

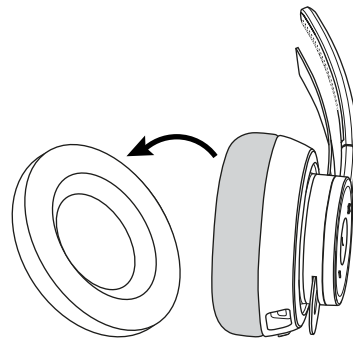

Raugiet, lai netiktu saspiests putu materiāla polsterējums, ko var viegli sabojāt.

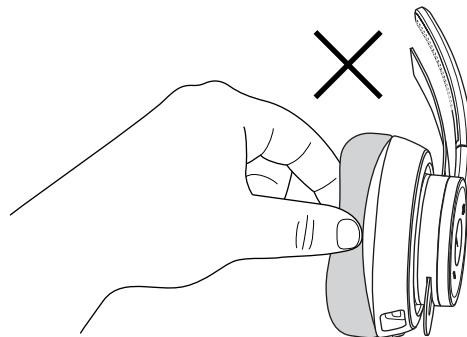

3. Ja putu materiāla polsterējums ir bojāts, veiciet tālāk norādītās darbības.
- Nolobiet putu materiāla polsterējumu un uzlieciet jaunu.

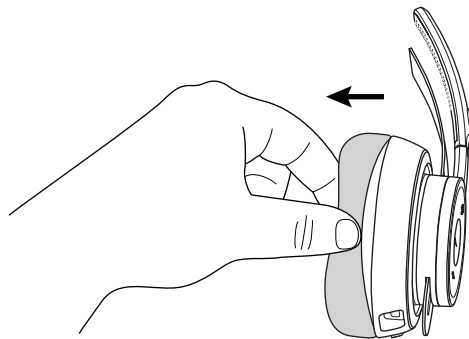

- Vispirms uzlieciet līmteni uz auss uzliktņa.

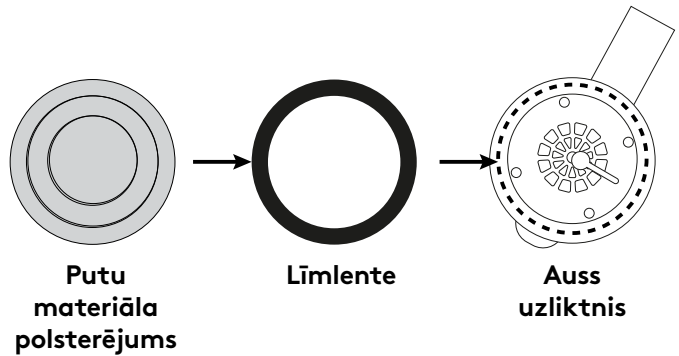

- Tad pie līmentes nostipriniet putu materiāla polsterējumu.

4. Satveriet jauno austiņu pārsegu un pārliecinieties, ka mazās atveres sānos atrodas simetriski attiecībā pret auss uzliktņa augšpusi un apakšpusi. Atverei jāsavietojas ar USB C pieslēgvietu apakšā.

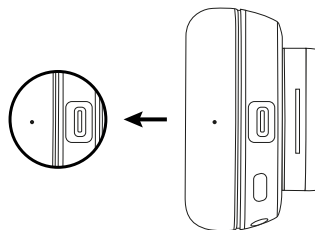

5. Sākot no augšas, ievietojiet austiņu pārsega malu spraugā. Ievietojiet pārsega malu spraugā apkārt auss uzliktnim.

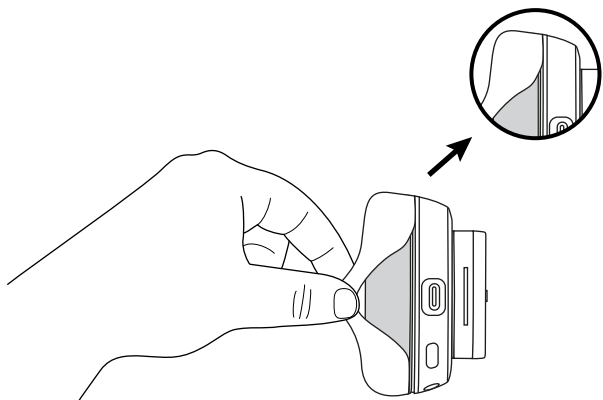

6. Pēc tam vairākas reizes maigi saspiediet auss uzliktni, lai izspiestu ārā gaisu.

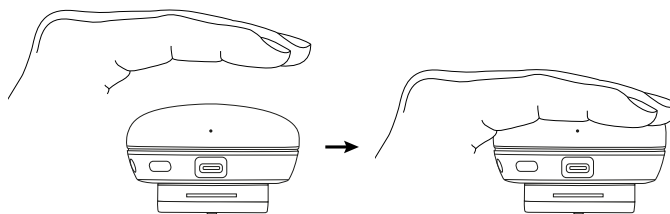

IZMĒRI

AUSTIŅU PĀRSEGI:

augstums x platumums x dziļums: 70,7 mm x 70,7 mm x 16,4 mm

www.logitech.com/support/zone-wireless-earpad-covers

SUSIPAŽINKITE SU SAVO PRODUKTU

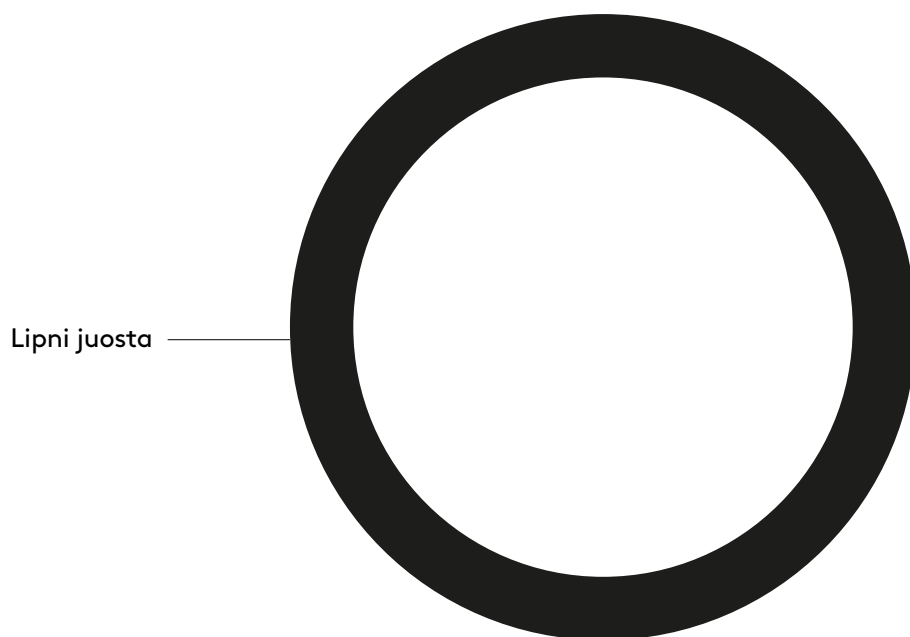
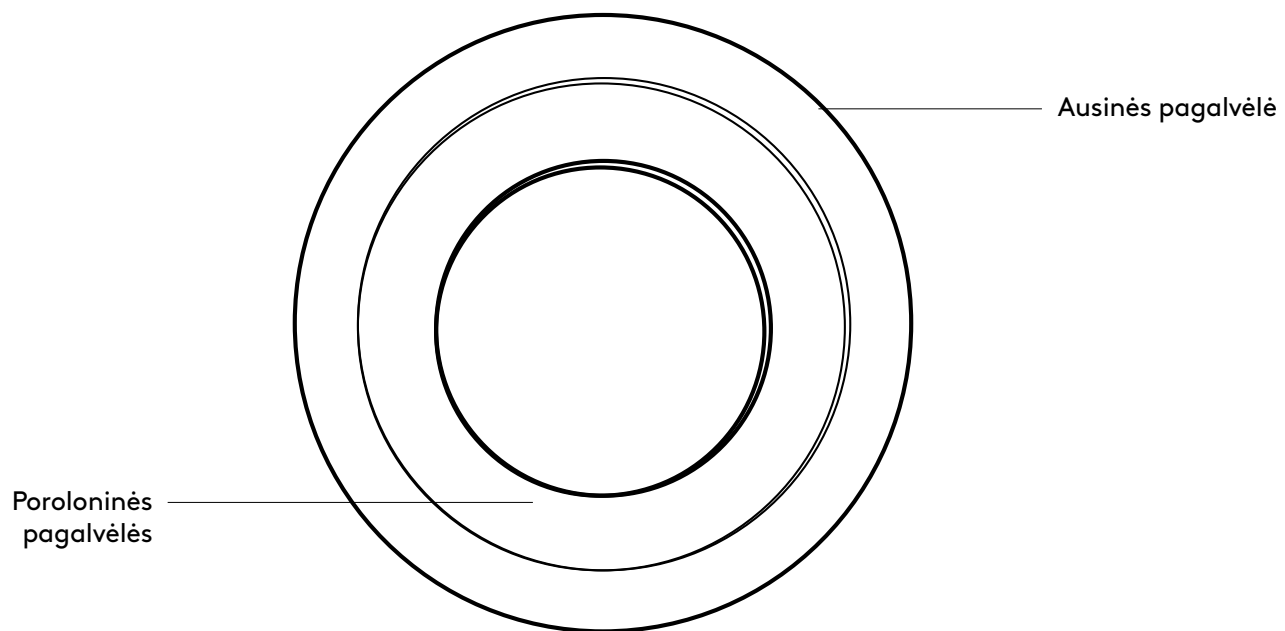

DĖŽUTĖJE YRA

1. 1 pora (2 vnt.) keičiamų ausinių pagalvėlių
2. 1 pora (2 vnt.) poroloninių pagalvėlių
3. 1 pora (2 vnt.) lipnių juostų

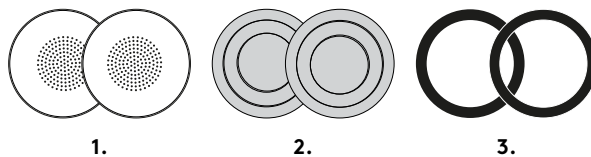

AUSINIŲ PAGALVĖLIŲ KEITIMAS

1. Nuimkite esamą ausinės pagalvėlę atsargiai sužnybdami pagalvėlę.

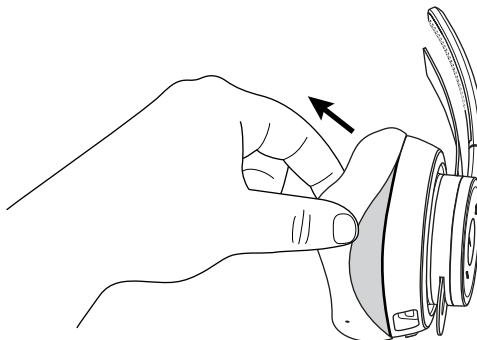

2. Ausinės pagalvėlę imkite lėtai, kol jis bus visiškai nuimta.

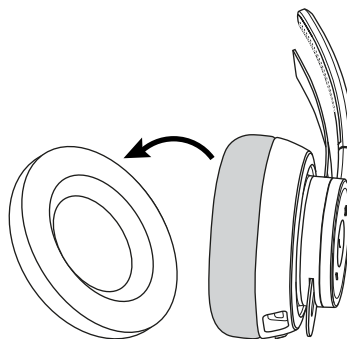

Nesužnybkite poroloninės pagalvėlės, kuri gali būti lengvai pažeista.

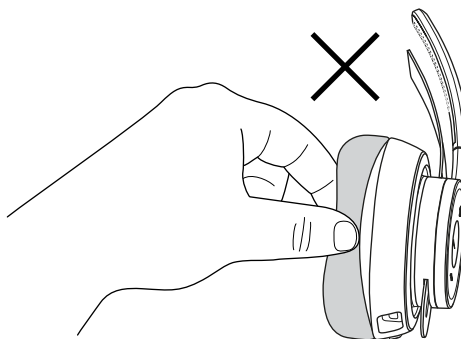

3. Jei poroloninė pagalvėlė yra pažeista, atlikite toliau nurodomus veiksmus.

a. Pašalinkite poroloninę pagalvėlę ir pakeiskite ją nauja.

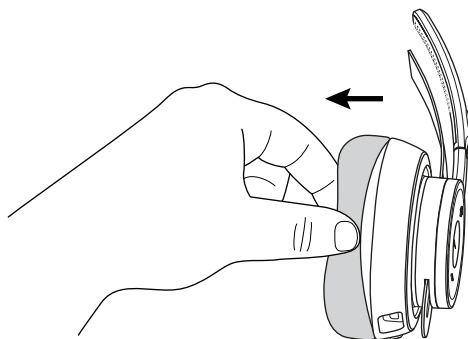

b. Pirmiausia ant ausinės viršaus uždėkite juostą.

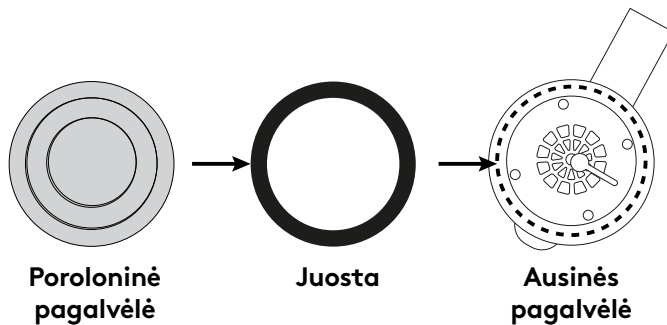

c. Tada pritvirtinkite poroloninę pagalvėlę prie juostos.

4. Paimkite naują ausinės pagalvėlę užtikrindami, kad mažos angos šone būtų išlygiuotos su ausinės viršumi ir apačia. Ji turėtų būti išlygiuota su USB C anga apačioje.

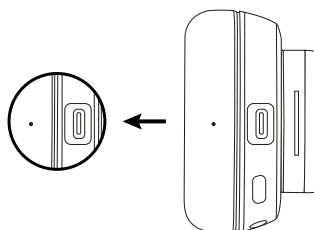

5. Pradėdami nuo viršaus, įstatykite ausinės pagalvėlės kraštą į plyšį. Įstatykite pagalvėlės kraštą į plyšį aplink ausinę.

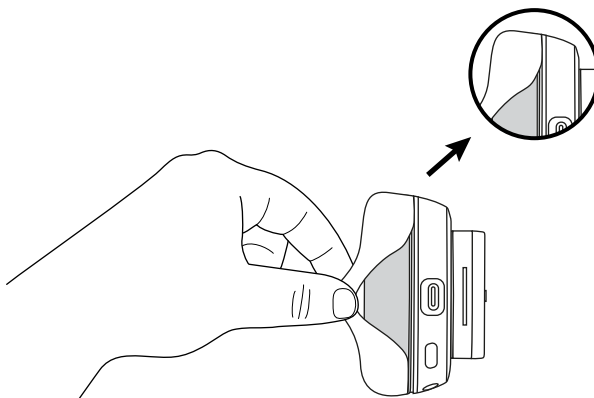

6. Baigę švelniai patapšnokite per ausinės pagalvėlę kelis kartus, kad būtų išstumtas oras.

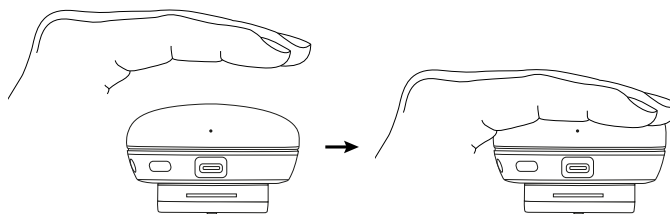

MATMENYS

AUSINĖS PAGALVĖLĖS:

aukštis x plotis x gylis: 70,7 mm x 70,7 mm x 16,4 mm

www.logitech.com/support/zone-wireless-earpad-covers

ЗАПОЗНАЙТЕ СЕ СЪС СВОЯ ПРОДУКТ

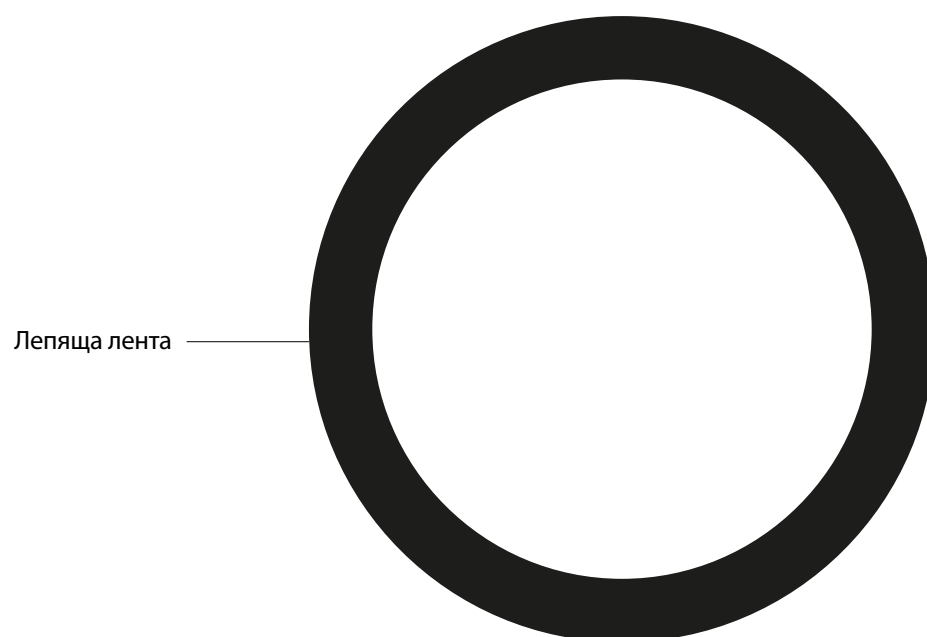
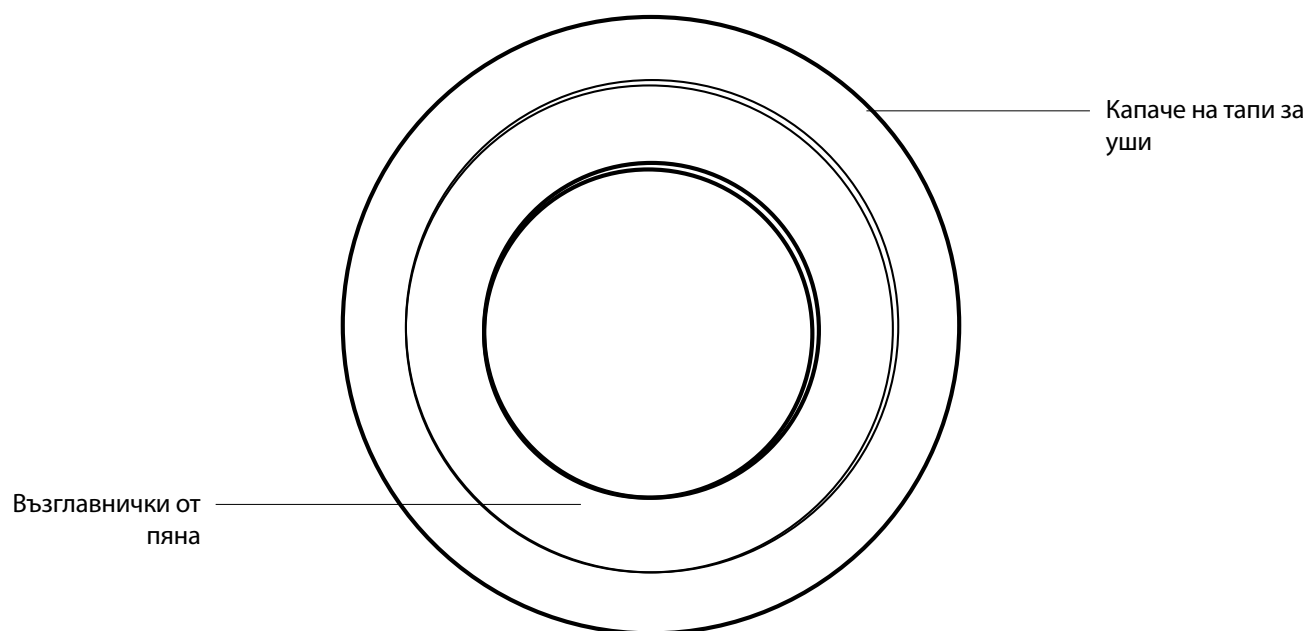

СЪДЪРЖАНИЕ НА КУТИЯТА

1. 1 чифт (2 броя) сменяеми капачета на тапи за уши
2. 1 чифт (2 броя) възглавнички от пяна
3. 1 чифт (2 броя) лепящи ленти

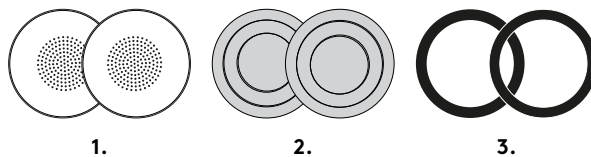

СМЯНА НА КАПАЧЕТА НА ТАПИ ЗА УШИ

1. Свалете наличното капаче на тапи за уши, като внимателно притиснете капачето.

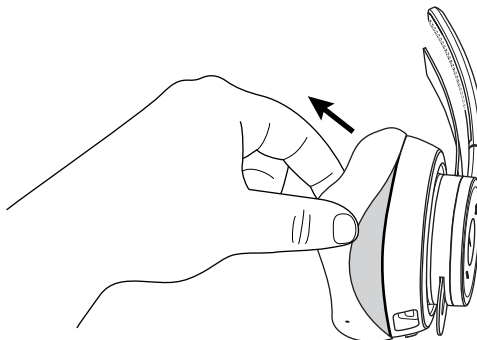

2. Свалете бавно капачето на тапите за уши, докато го отделите изцяло.

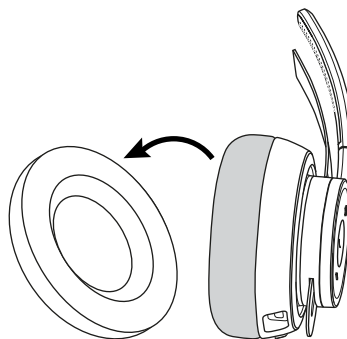

Внимавайте да не притиснете възглавничката от пяна, защото тя лесно може да се повреди.

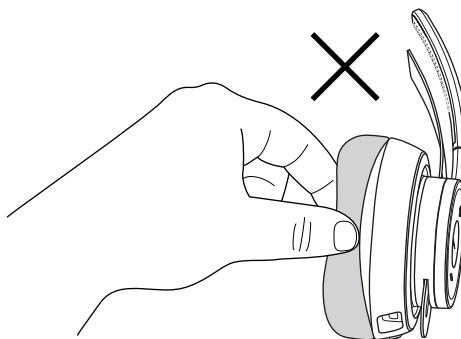

3. Ако възглавничката от пяна се повреди, следвайте стъпките по-долу.

a. Отлепете възглавничката от пяна и я сменете с нова.

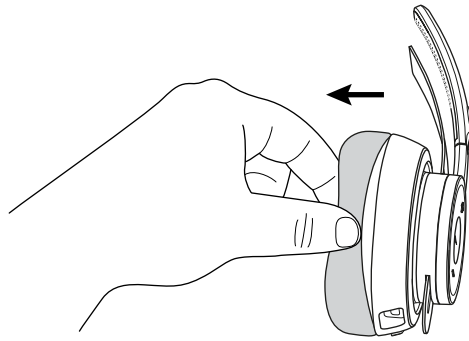

b. Най-напред поставете лентата най-отгоре върху капачето за уши.

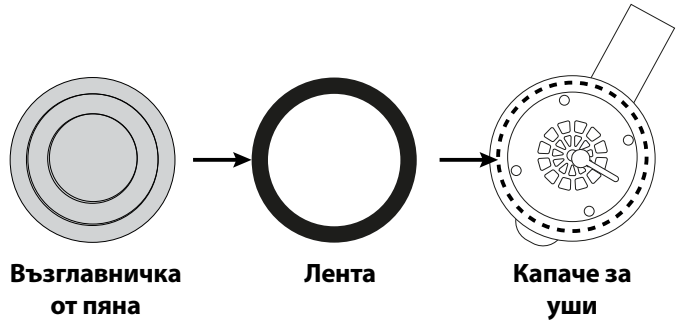

c. След това прикрепете възглавничката от пяна към лентата.

4. Хванете новото капаче на тапите за уши, като се уверите, че страничните малки отвори са подравнени с капачето за уши отгоре и отдолу. То трябва да се подравни с USB C порта най-отдолу.

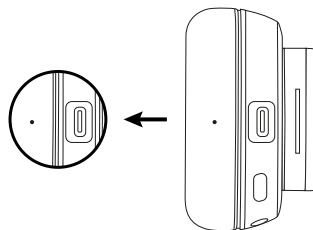

5. Започвайки най-отгоре, плъзнете края на капачето на тапите за уши в кушината. Поставете края на капачето в кушината, образувала се около ухото.

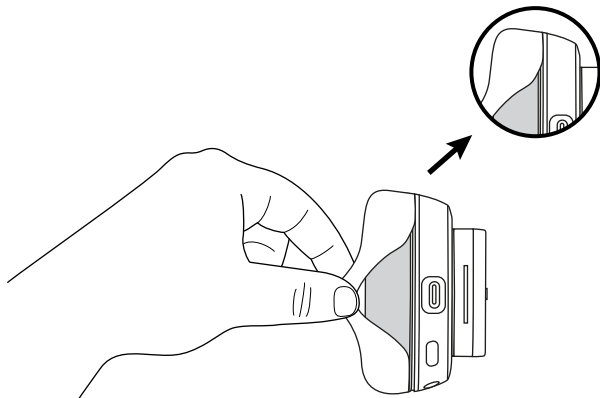

6. След като сте готови, внимателно потупайте капачето за уши няколко пъти, за да изгоните въздуха навън.

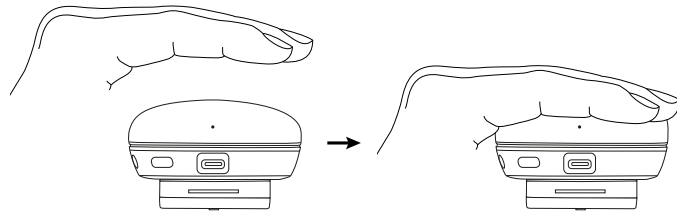

РАЗМЕРИ

КАПАЧЕТА НА ТАПИ ЗА УШИ:

Височина x ширина x дълбочина: 70,7 мм x 70,7 мм x 16,4 мм

www.logitech.com/support/zone-wireless-earpad-covers

UPOZNAJTE SVOJ UREĐAJ

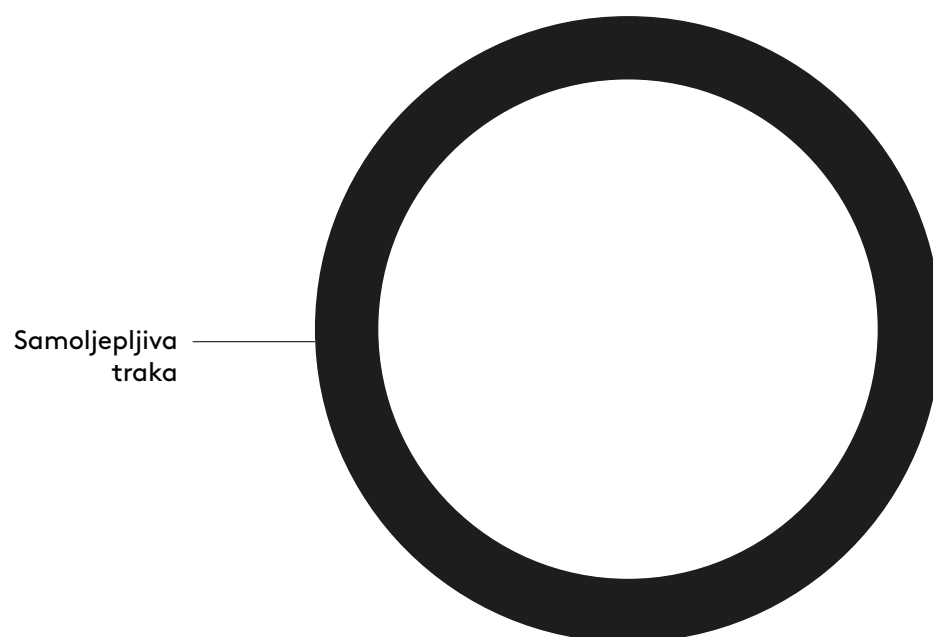
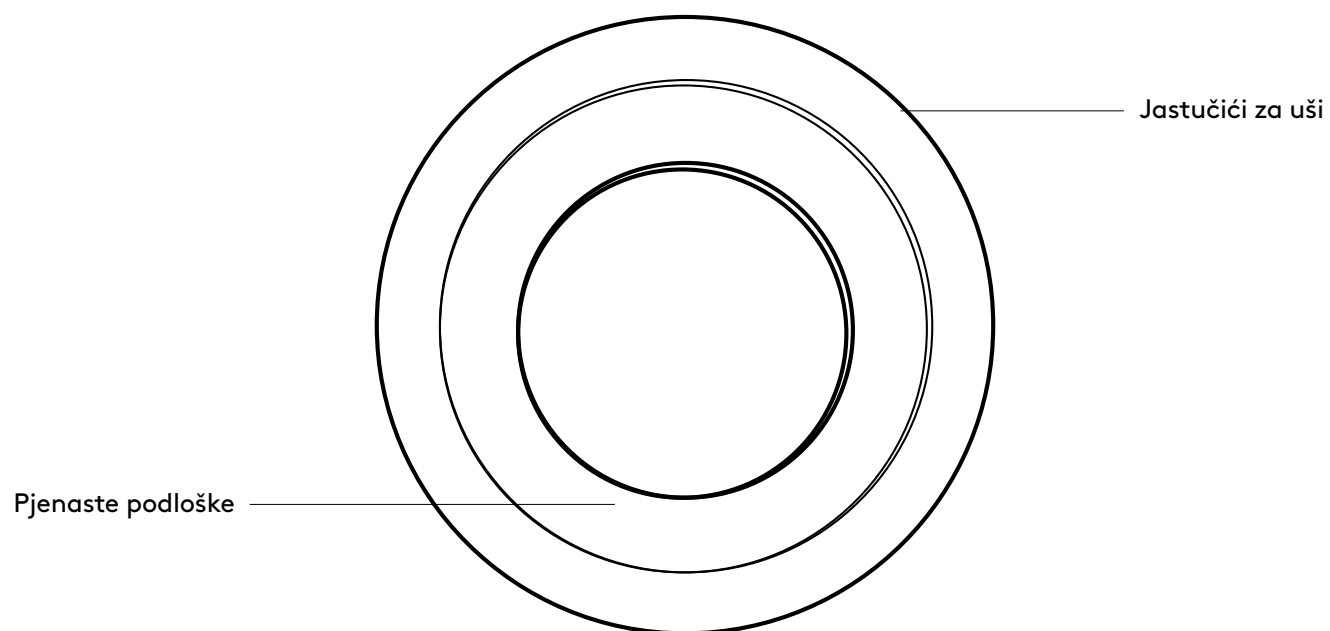

ŠTO JE U KUTIJI

1. 1 par (2 kom) zamjenjivih jastučića za uši
2. 1 par (2 kom) pjenastih podložki
3. 1 par (2 kom) smoljepljivih traka

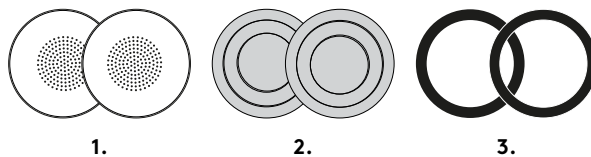

ZAMJENA JASTUČIĆA ZA UŠI

1. Skinite postojeće jastučiće polaganim pridržavanjem za vrh.

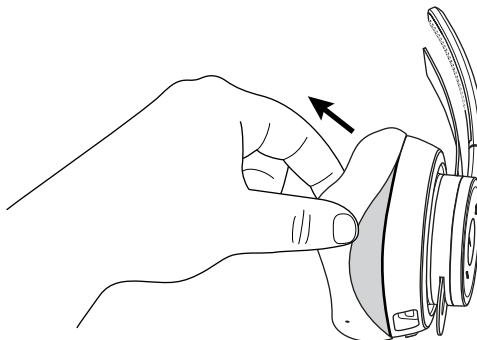

2. Polagano odstranite jastučiće dok se u potpunosti ne skinu.

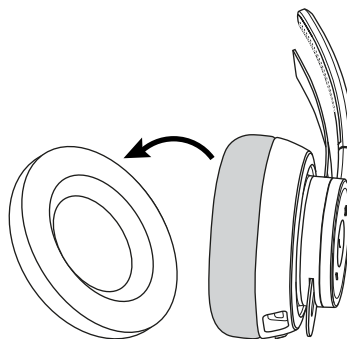

Provjerite da ne pritišćete pjenaste jastučiće jer se mogu oštetiti.

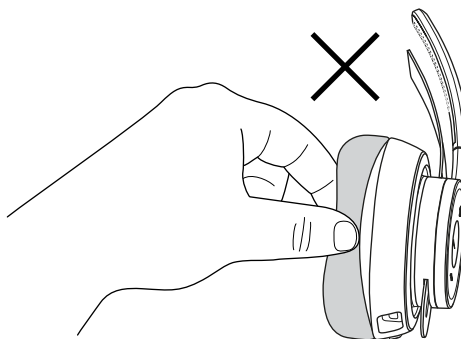

3. Ako je pjenasti jastučić oštećen molimo slijedite dolje navedene korake.
a. Skinite jastučić i zamijenite ga novim.

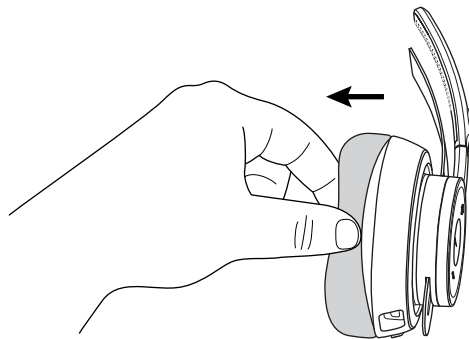

- b. Traku stavite na gornji dio podloške za uho.

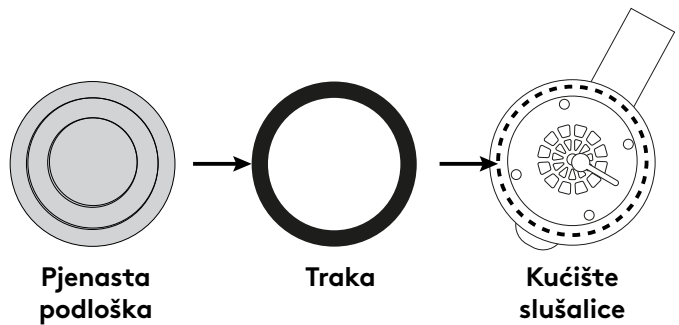

- c. Zatim jastučić pričvrstite trakom.

4. Prihvatite novi jastučić i pobrinite se da se maleni otvori na bočnoj strani poravnaju s gornjim i donjim dijelom podloške za uho. Trebala bi se poravnati s USB C portom na dnu.

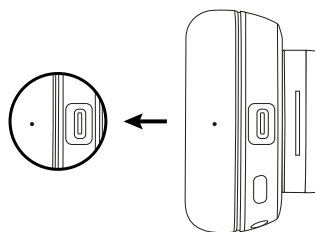

5. Započevši od gornjeg dijela, umetnite rub podloške za uho u otvor. Rub poklopca stavite u otvor oko kućišta slušalice.

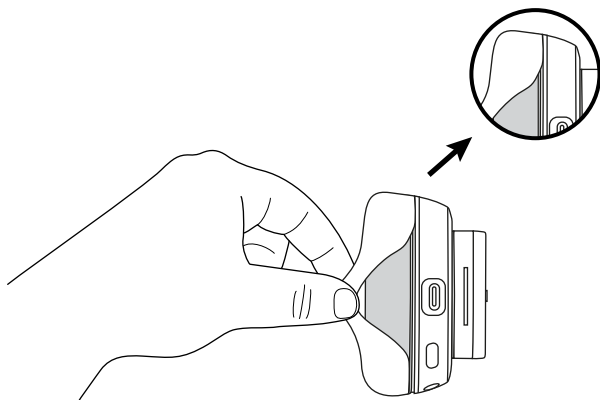

6. Nakon završetka ove radnje polagano dodirnite nekoliko puta kućište slušalice kako biste istisnuli zrak.

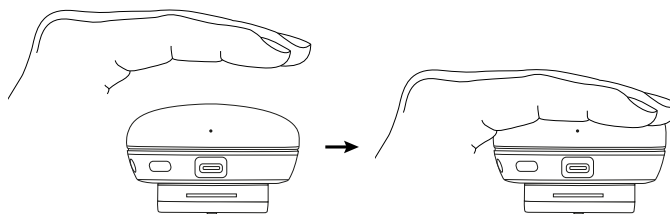

DIMENZIJE

JASTUČIĆI ZA UŠI:

Visina x širina x dubina: 70,7 mm x 70,7 mm x 16,4mm

www.logitech.com/support/zone-wireless-earpad-covers

UPOZNAJTE SVOJ PROIZVOD

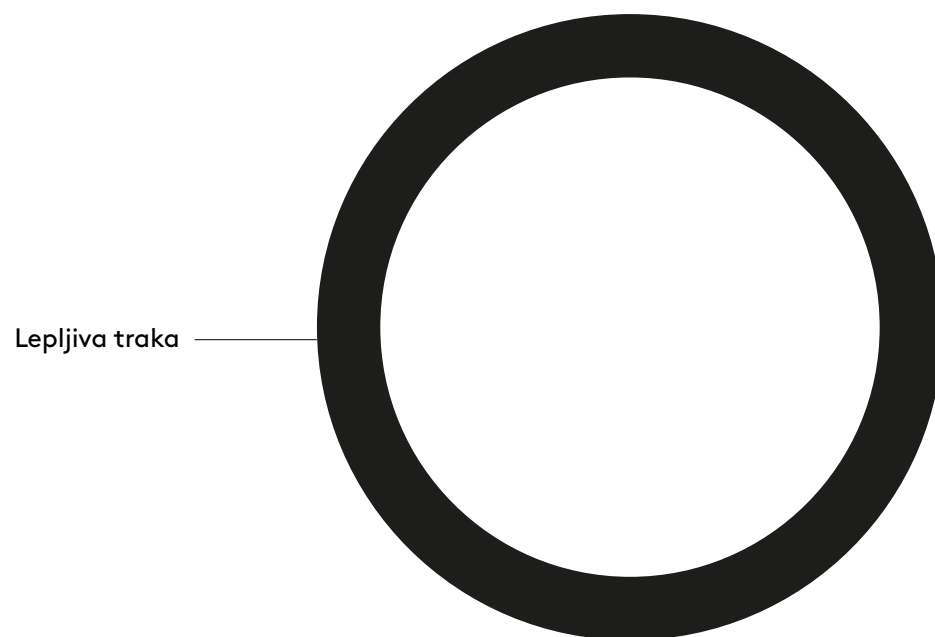
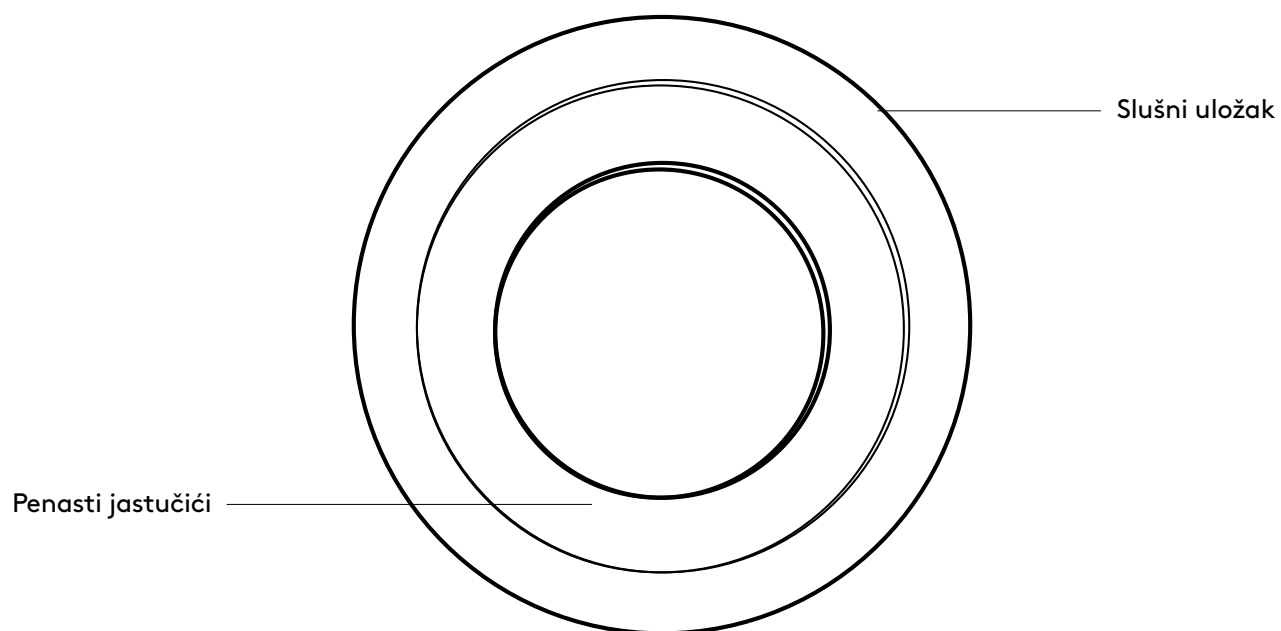

SADRŽAJ PAKOVANJA

1. 1 par (2 kom.) zamjenjivih slušnih uložaka
2. 1 par (2 kom.) penastih jastučića
3. 1 par (2 kom.) lepljivih traka

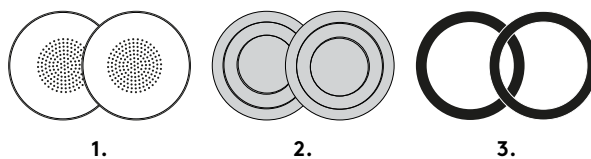

ZAMENJIVI SLUŠNI ULOŠCI

1. Pažljivo uhvatite prstima postojeći slušni uložak i skinite ga.

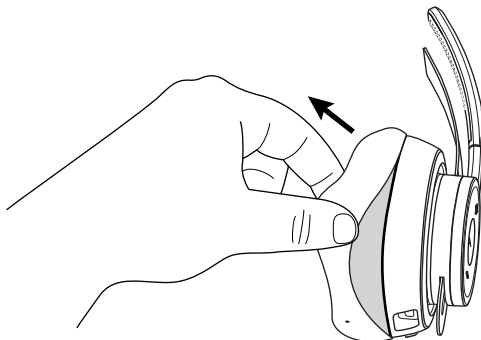

2. Polako skidajte slušni uložak dok ga potpuno ne uklonite.

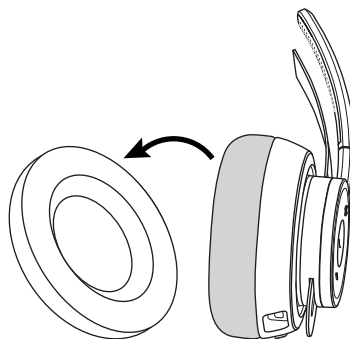

Pazite da prstima ne uhvatite penasti jastučić, jer se lako oštećuje.

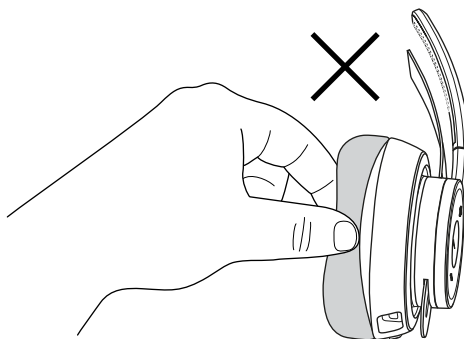

3. Ako se penasti jastučić ošteti, pratite korake u nastavku.

a. Skinite penasti jastučić i zamenite ga novim.

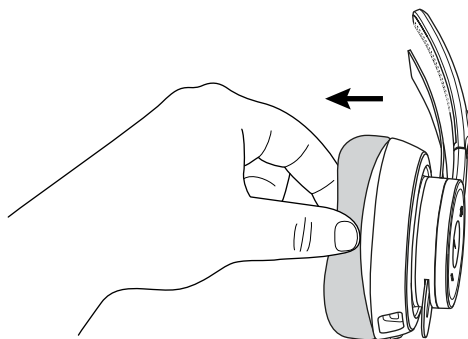

b. Prvo postavite traku na gornji deo kućišta slušalice.

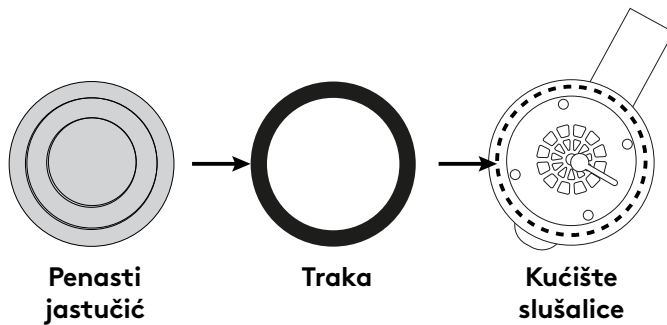

c. Zatim pričvrstite penasti jastučić na traku.

4. Postavite novi slušni uložak tako da se mali otvori sa strane poravnaju sa gornjim i donjim delom kućišta slušalice. Treba ga poravnati sa USB C portom na donjem delu.

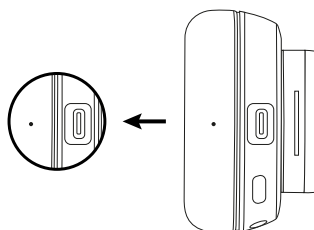

5. Počevši od gornjeg dela, uvlačite ivicu slušnog uložka u otvor. Postavljajte ivicu uložka u otvor oko kućišta slušalice.

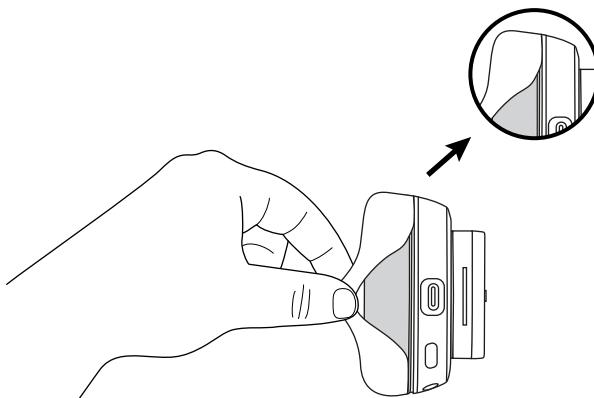

6. Kada završite, lagano udarite rukom po kućištu slušalice da biste izbacili vazduh.

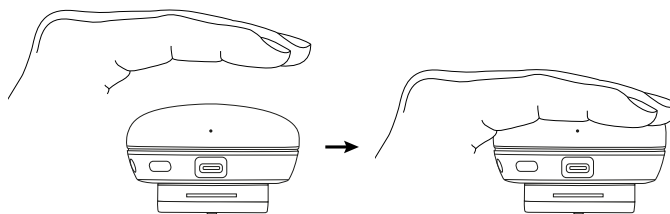

DIMENZIJE

SLUŠNI ULOŠCI:

Visina x širina x dužina: 70,7 mm x 70,7 mm x 16,4 mm

www.logitech.com/support/zone-wireless-earpad-covers

OPIS PRODUKTU

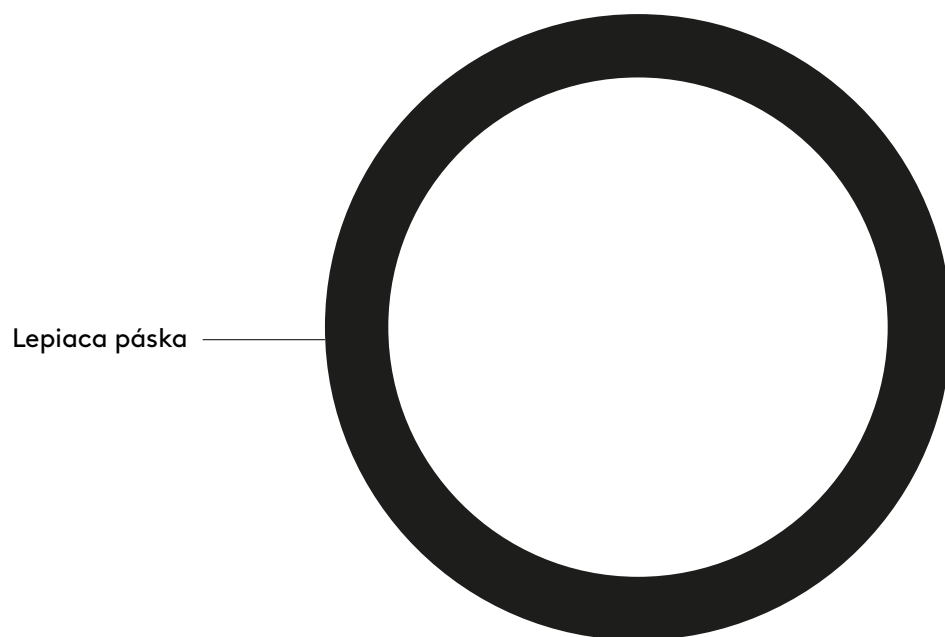
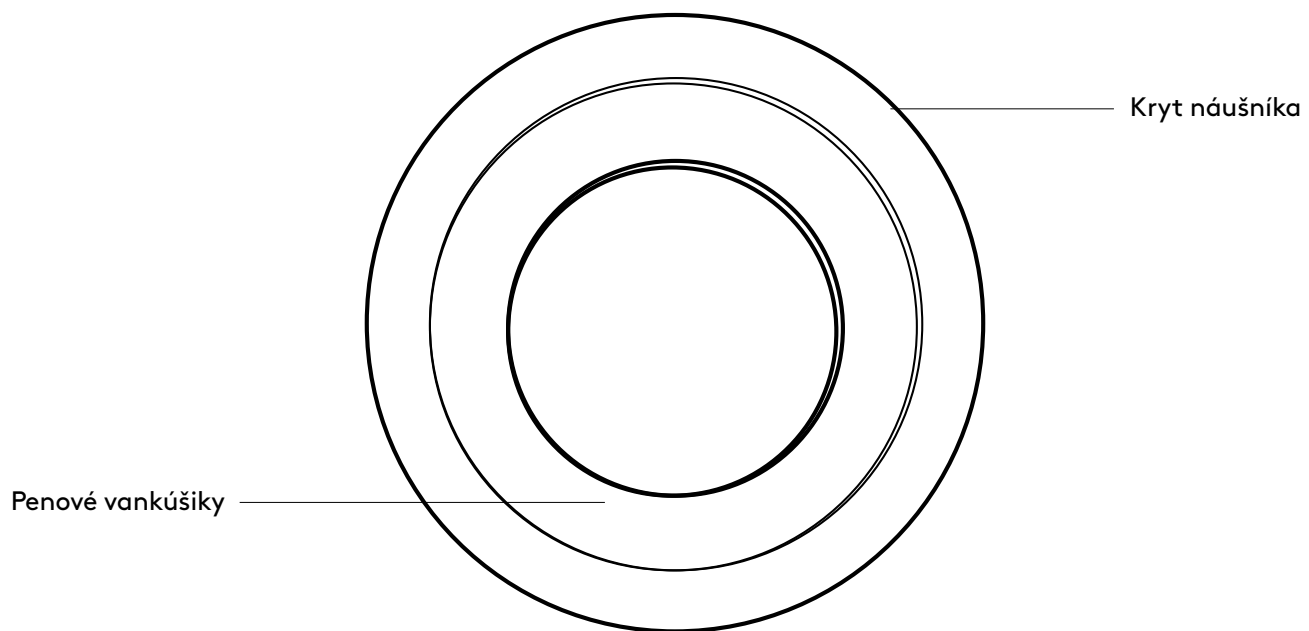

OBSAH BALENIA

1. 1 pár (2 ks) výmenných krytov náušníkov
2. 1 pár (2 ks) penových vankúšikov
3. 1 pár (2 ks) lepiacich pásov

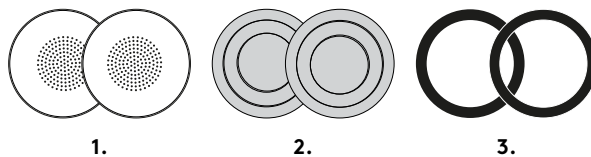

VÝMENA KRYTOV NÁUŠNÍKOV

1. Existujúci kryt náušníka opatrne snímte tým, že ho stlačíte.

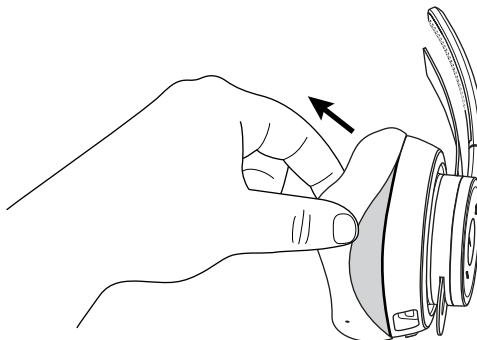

2. Pomaly ťahajte za kryt náušníka, kým ho celkom nesnímete.

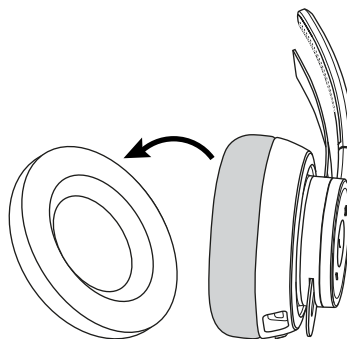

Dbajte na to, aby ste nestlačili penový vankúšik, ktorý sa ľahko poškodí.

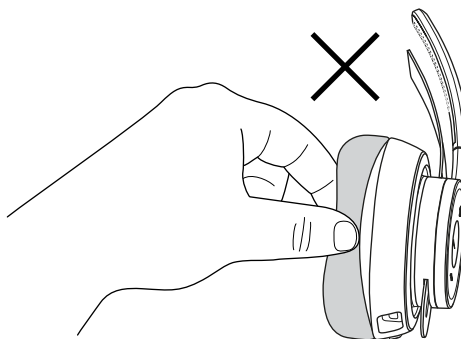

3. V prípade poškodenia penového vankúšika postupujte podľa pokynov nižšie.
- Odlepte penový vankúšik a vymeňte ho za nový.

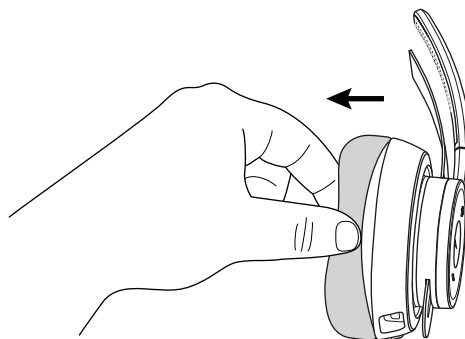

- Najprv nalepte pásku na vršok náušníka.

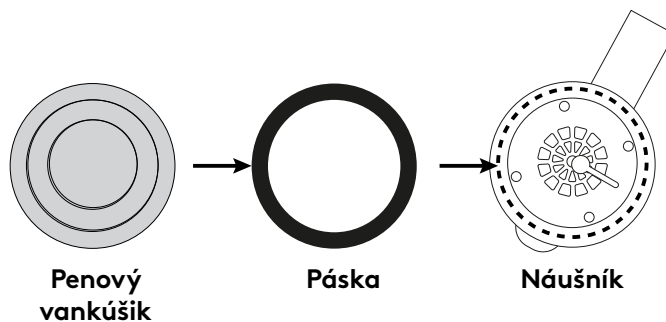

- Potom nalepte penový vankúšik k páske.

4. Uchopte nový kryt náušníka, pričom dbajte na to, aby sa malé otvory na boku vyrovnali s vrškom a spodkom náušníka. Mali by sa vyrovnať s portom USB C v spodnej časti.

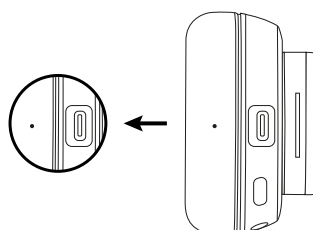

5. Začnite z vrchu a vložte okraj krytu náušníka do otvoru. Vložte okraj krytu do otvoru po celom obvode.

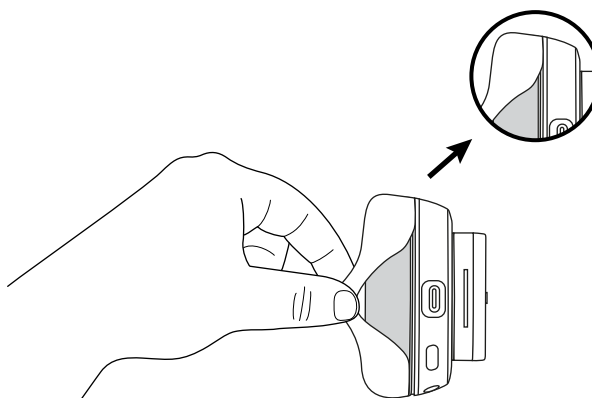

6. Po dokončení jemne niekoľkokrát prejdite po náušníku, čím vytlačíte zvyšný vzduch.

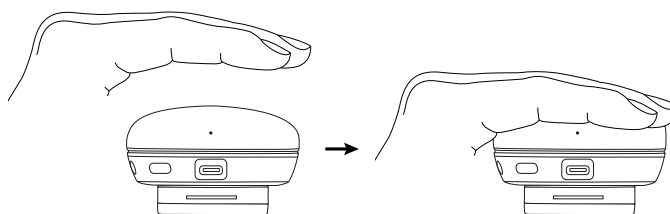

ROZMERY

KRYTY NÁUŠNÍKOV:

Výška x šírka x hĺbka: 70,7 mm x 70,7 mm x 16,4mm

www.logitech.com/support/zone-wireless-earpad-covers

FAMILIARIZAȚI-VĂ CU PRODUSUL

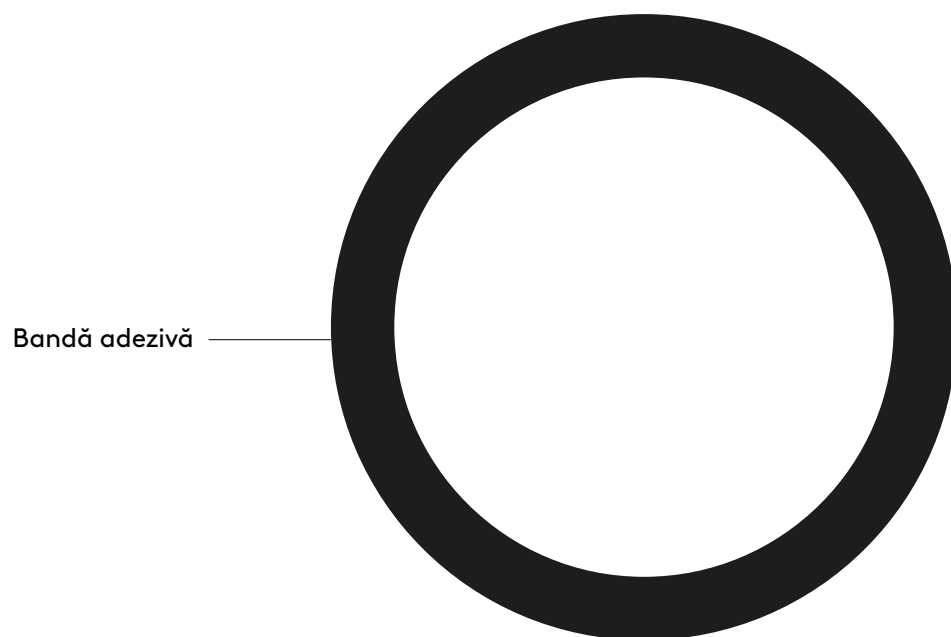
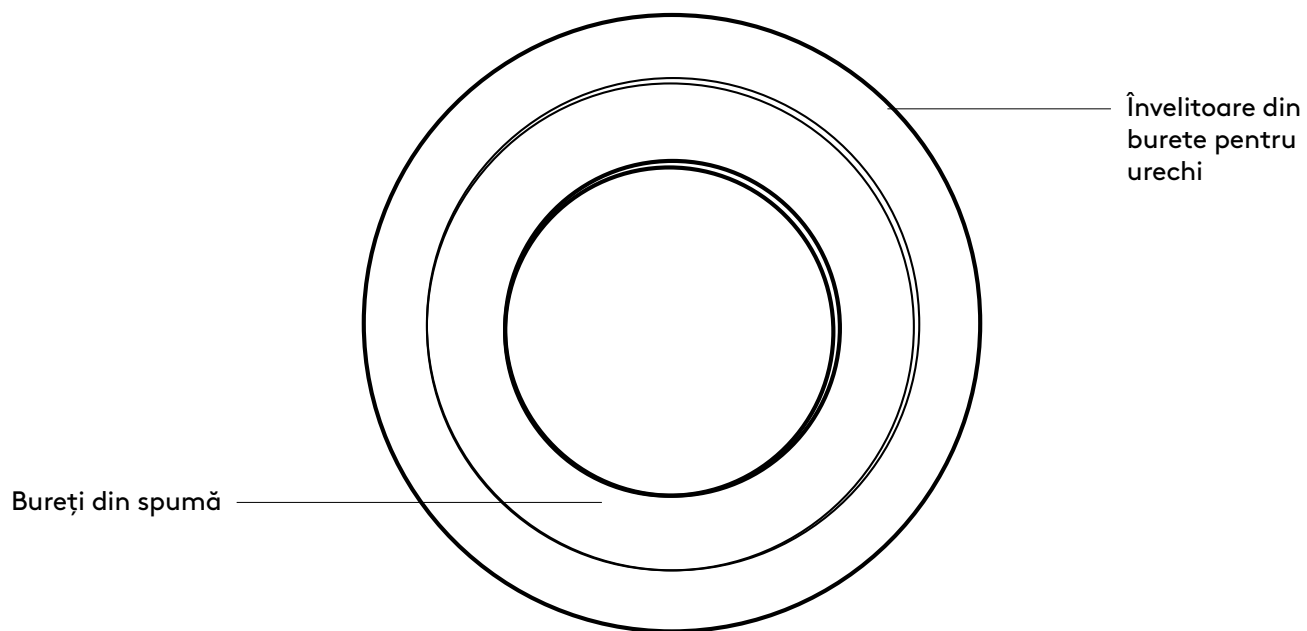

CONȚINUTUL CUTIEI

1. 1 pereche (2 bucăți) de învelitoare înlocuibile din burete pentru urechi
2. 1 pereche (2 bucăți) de bureți din spumă
3. 1 pereche (2 bucăți) de benzi adezive

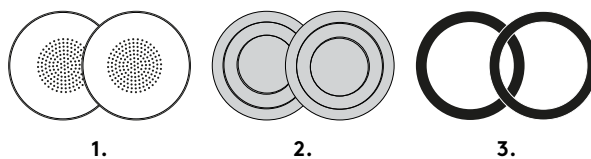

ÎNLOCUIREA ÎNVELITOARELOR DIN BURETE PENTRU URECHI

1. Îndepărtați actuala învelitoare din burete pentru urechi prin ciupirea ușoară a învelitorii.

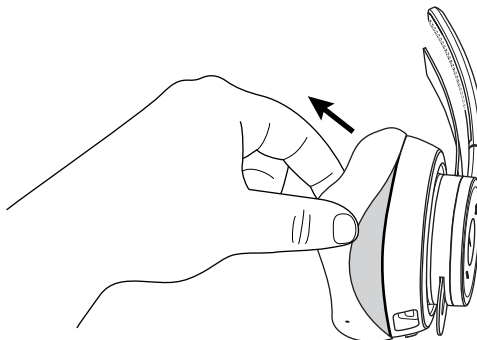

2. Trageți ușor de învelitoare astfel, până când este îndepărtată complet.

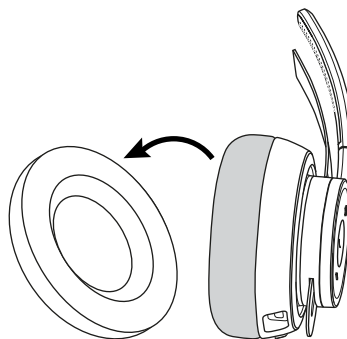

Aveți grijă să nu ciupiți buretele de spumă deoarece acesta este ușor de deteriorat.

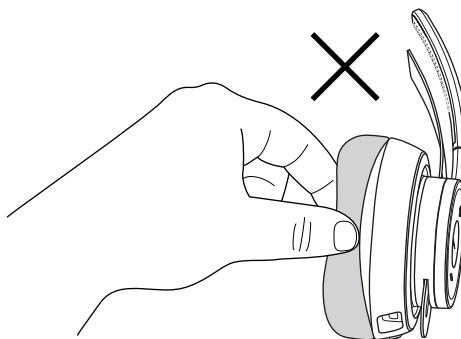

3. Dacă buretele de spumă este deteriorat, urmați pașii de mai jos.
- Dezlipiți buretele de spumă și înlocuiți-l cu unul nou.

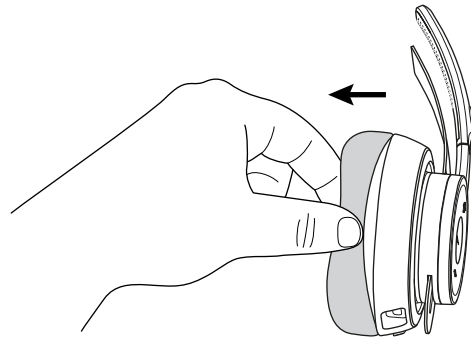

- Amplasați banda adezivă peste partea de sus a suportului pentru ureche.

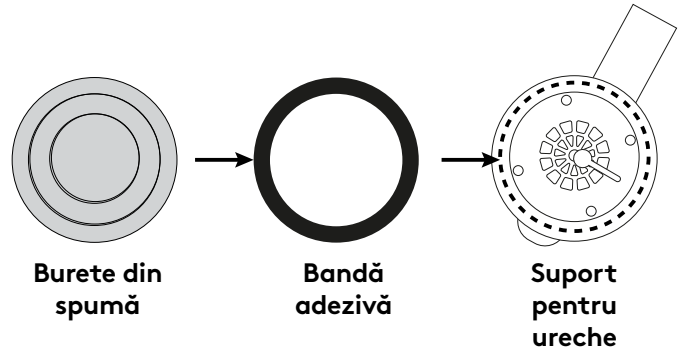

- Lipiți apoi buretele de spumă de banda adezivă.

4. Apucați bine de noua învelitoare din burete pentru urechi și asigurați-vă că micile orificii de pe părți se aliniază cu partea de sus și de jos a suportului pentru ureche. Învelitoarea trebuie să se alinieze cu portul USB-C din partea de jos.

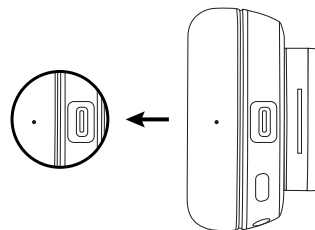

5. Începând cu partea de sus, introduceți marginea învelitorii din burete în spațiul liber. Introduceți marginea învelitorii în spațiul liber din jurul suportului pentru ureche.

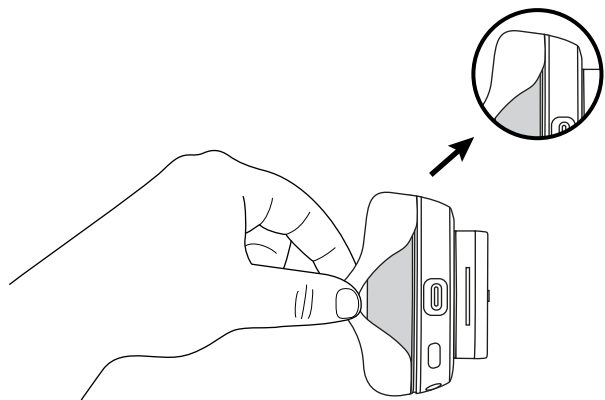

6. Când terminați, apăsați încet pe suportul pentru ureche de câteva ori pentru a împinge aerul afară.

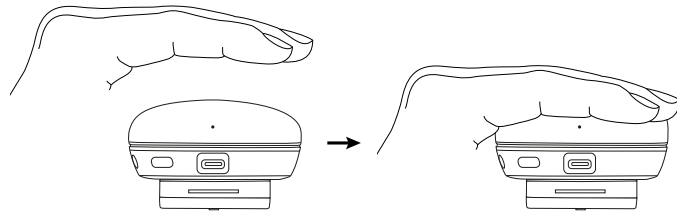

DIMENSIUNI

ÎNVELITOARE DIN BURETE PENTRU URECHI:

Înălțime x lățime x adâncime: 70,7 mm x 70,7 mm x 16,4 mm

www.logitech.com/support/zone-wireless-earpad-covers

ÜRÜNÜNÜZÜ TANIYIN

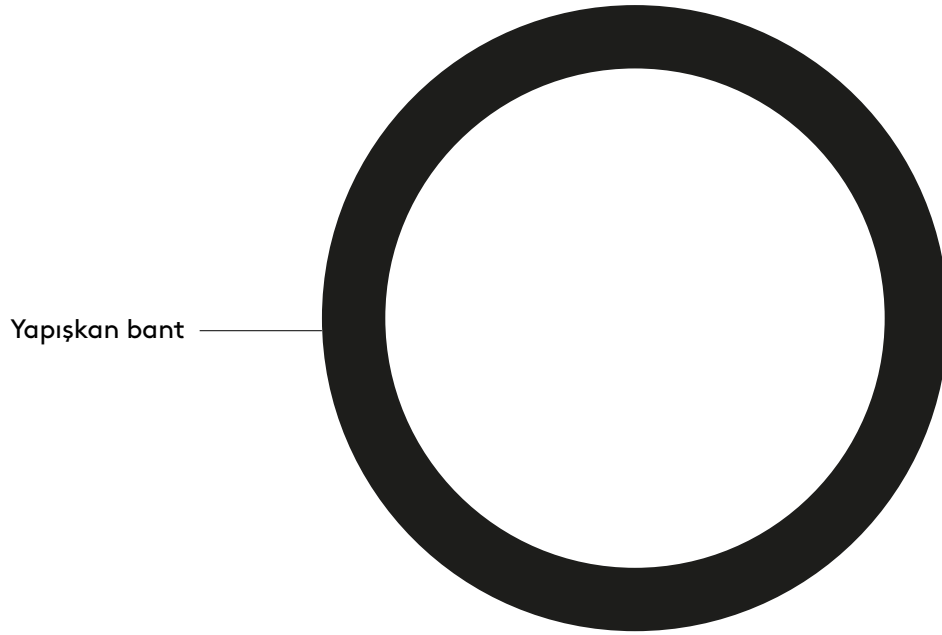
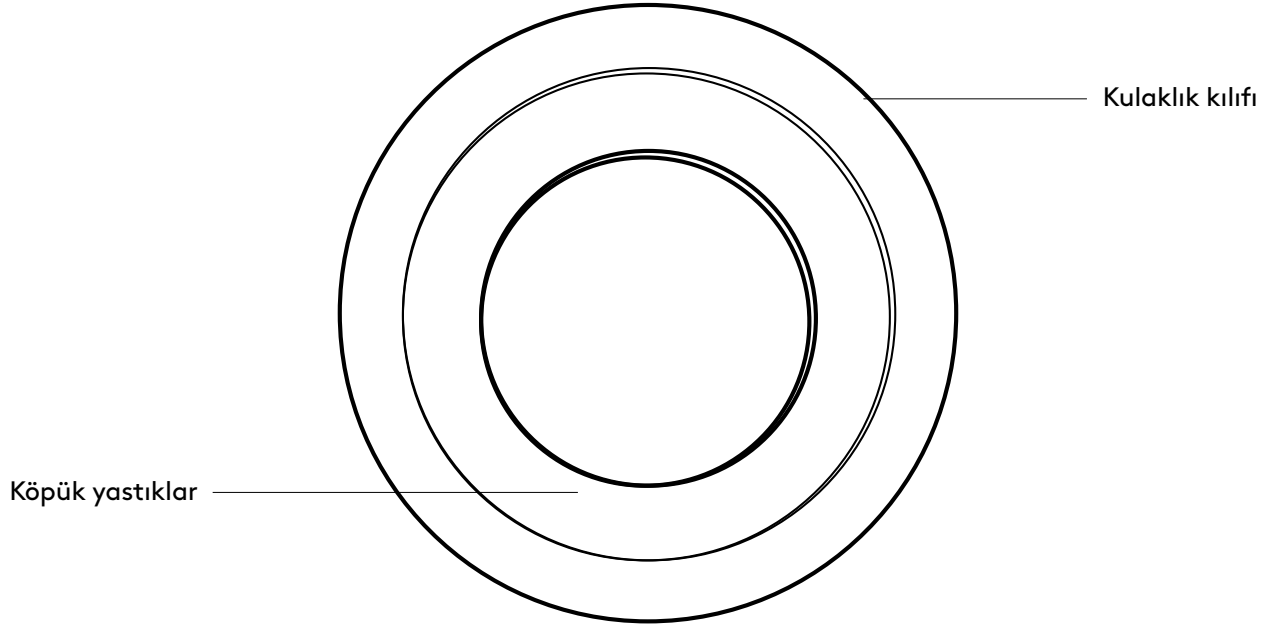

KUTUNUN İÇİNDEKİLER

1. 1 çift (2 parça) yedek kulaklık kılıfı
2. 1 çift (2 parça) köpük yastık
3. 11 çift (2 parça) yapışkan bant

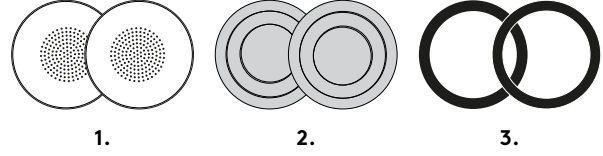

KULAKLIK KILIFLARINI DEĞİŞTİRME

1. Takılı kulaklık kılıfını dikkatle tutarak çıkarın.

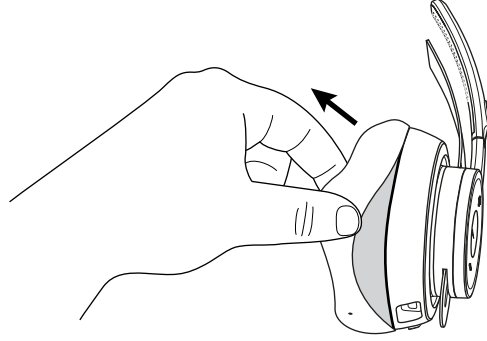

2. Kulaklık kılıfını yavaşça ve tümüyle çıkarın.

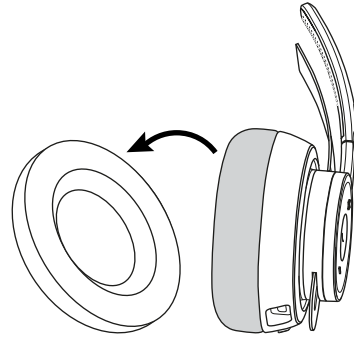

Kolayca hasar görebilecek köpük yastığı sıkıştırmamaya dikkat edin.

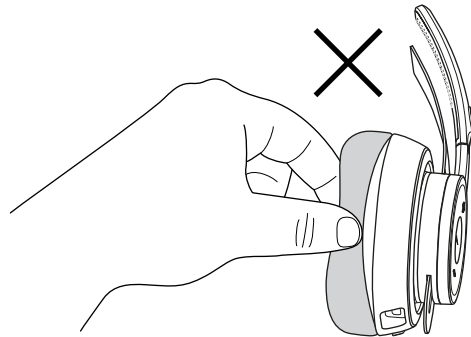

3. Yastık hasar görürse lütfen aşağıdaki adımları izleyin.
a. Köpük yastığı çıkarın ve yenisini takın.

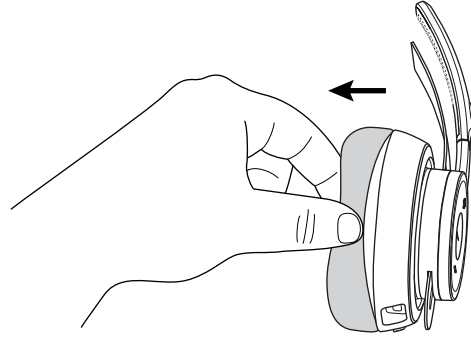

- b. Bandı kulağa giren parçanın üstüne yerleştirin.

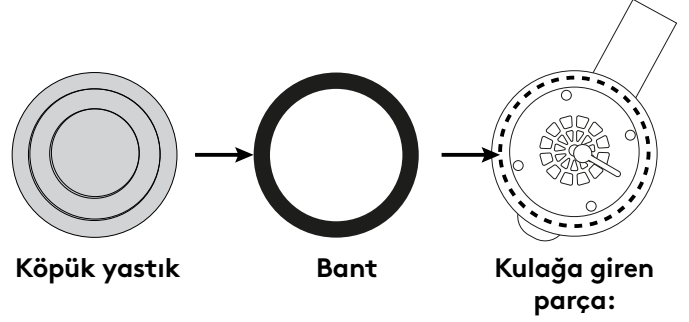

- c. Ardından köpük yastığı banda yapıştırın.

4. Yan taraftaki küçük deliklerin kulağa giren parçanın üst ve alt kısmıyla aynı hizada olduğundan emin olarak yeni kulaklık kılıfını sıkıca tutun. Alttaki USB C bağlantı noktasıyla aynı hizada olmalıdır.

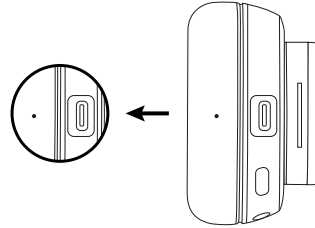

5. Üstten başlayarak kulaklık kılıfının kenarını boşluğa yerleştirin. Kılıfın kenarını kulaklığın etrafındaki boşluğa yerleştirin.

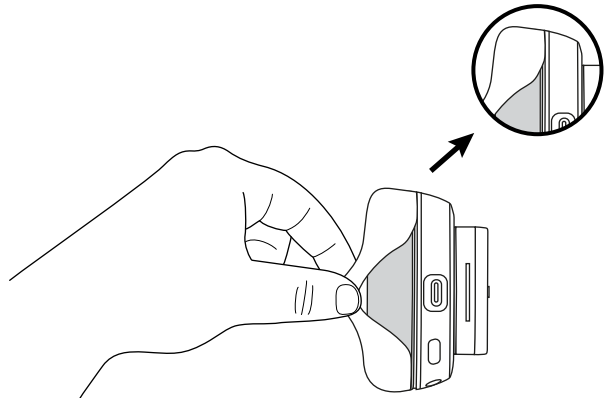

6. Bitirdikten sonra kulaklığa birkaç defa yumuşak bir hareketle vurarak içerideki havanın dışarı çıkmasını sağlayın.

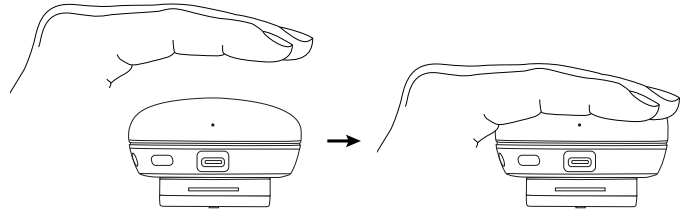

BOYUTLAR

KULAKLIK KILIFLARI:

Yükseklik x Genişlik x Derinlik: 70,7 mm x 70,7 mm x 16,4mm

www.logitech.com/support/zone-wireless-earpad-covers

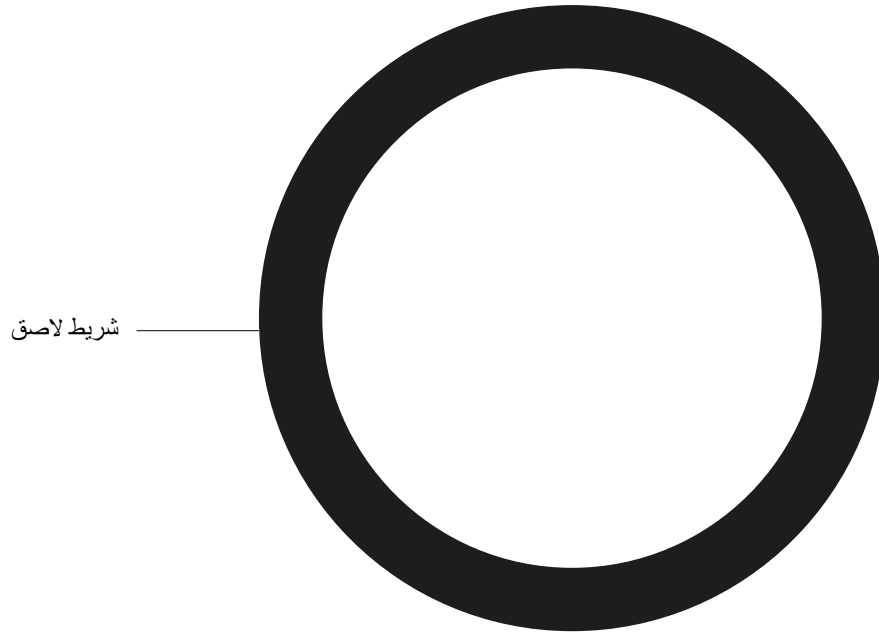
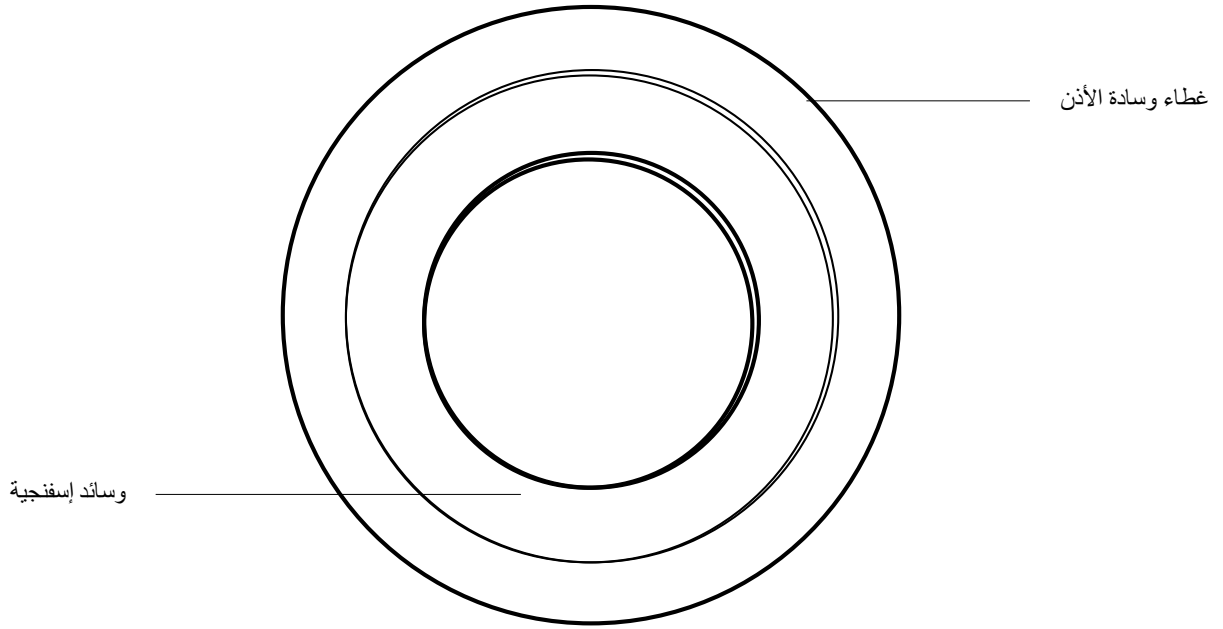

محتويات العبوة

1. زوج واحد (قطعتان) من أغطية وسادة الأذن القابلة للاستبدال
2. زوج واحد (قطعتان) من الوسائد الإسفنجية
3. زوج واحد (قطعتان) من الأشرطة اللاصقة

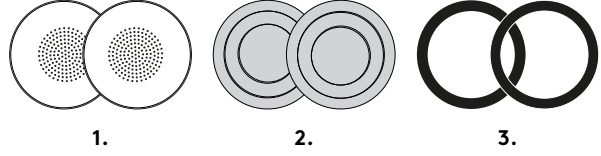

أغطية وسادة الأذن البديلة

1. قم بخلع غطاء وسادة الأذن الحالية من خلال نزع الغطاء بعناية.

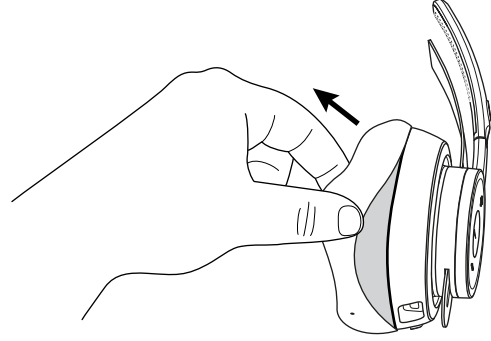

2. قم بإزالة غطاء وسادة الأذن ببطء حتى يخرج تمامًا. تأكد من عدم الضغط على الوسادة الإسفنجية نفسها حيث

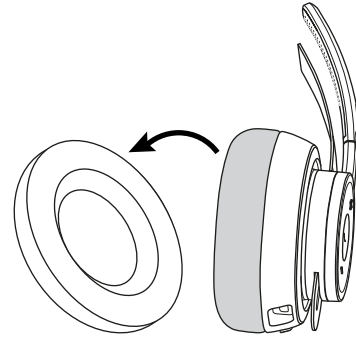

يمكن أن تتعرض للتلف بسهولة.

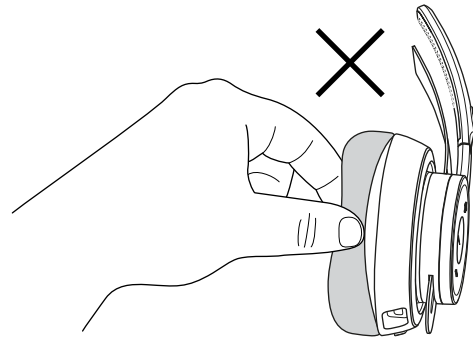

3. إذا تعرضت الوسادة الإسفنجية للتلف، فيرجى اتباع الخطوات أدناه.

a. قم بنزع الوسادة الإسفنجية واستبدلها بوسادة جديدة.

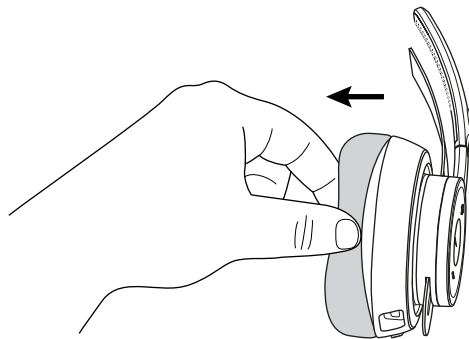

b. قم بوضع الشريط اللاصق على قمة غطاء الأذن أولاً.

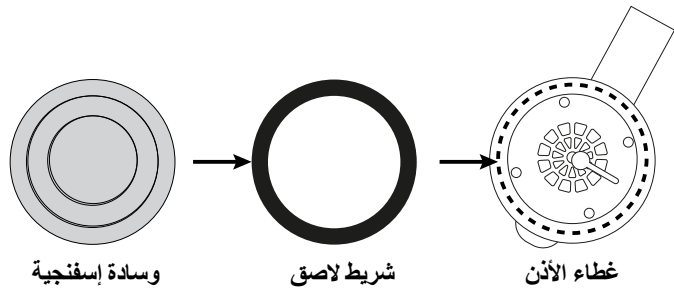

c. ثم تثبت الوسادة الإسفنجية بالشريط اللاصق.

4. شد غطاء وسادة الأذن الجديد برفق لتثبيتته، وتأكد من أن الفتحات الصغيرة الموجودة على الجانب تتوافق مع الجزء العلوي والسفلي لغطاء الأذن. يجب أن تتوافق مع منفذ USB-C في الأسفل.

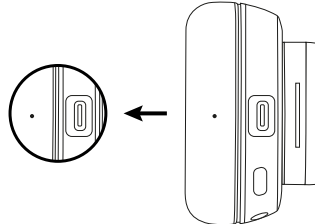

5. بدءاً من الجزء العلوي، أدخل حافة غطاء وسادة الأذن داخل الفجوة. ضع حافة الغطاء في الفجوة حول مشبك سماعة الأذن.

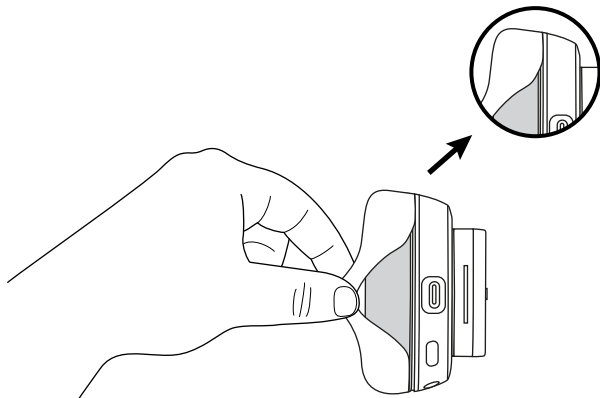

6. بعد الانتهاء، ربيّت برفق على غطاء الأذن عدة مرات لدفع الهواء نحو الخارج.

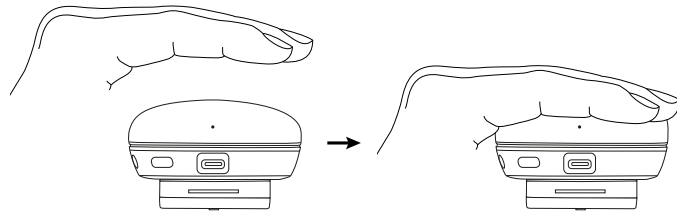

الأبعاد

غطاء وسادة الأذن:

الطول × العرض × السُمك: 70.7 مم × 70.7 مم × 16.4 مم

www.logitech.com/support/zone-wireless-earpad-covers

הכר את המוצר

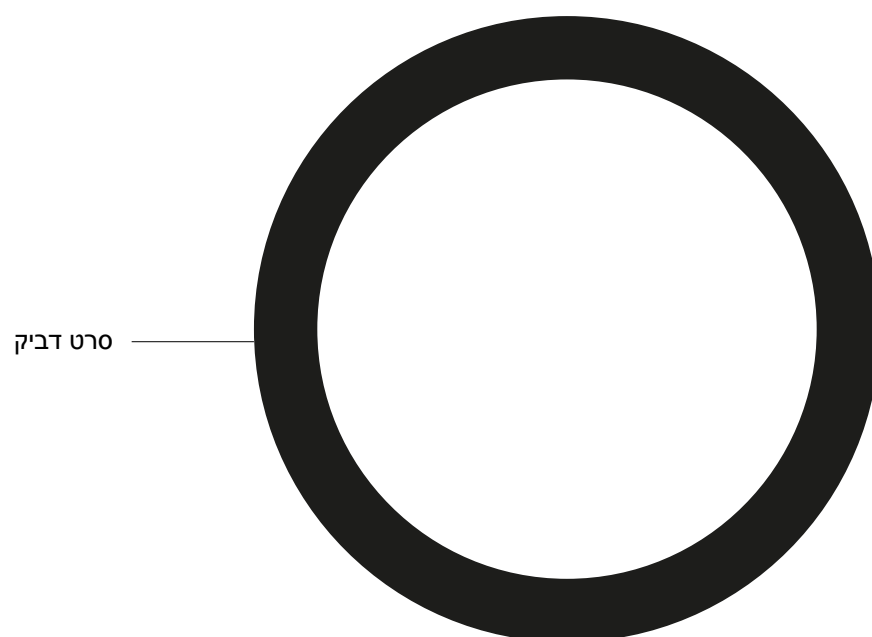
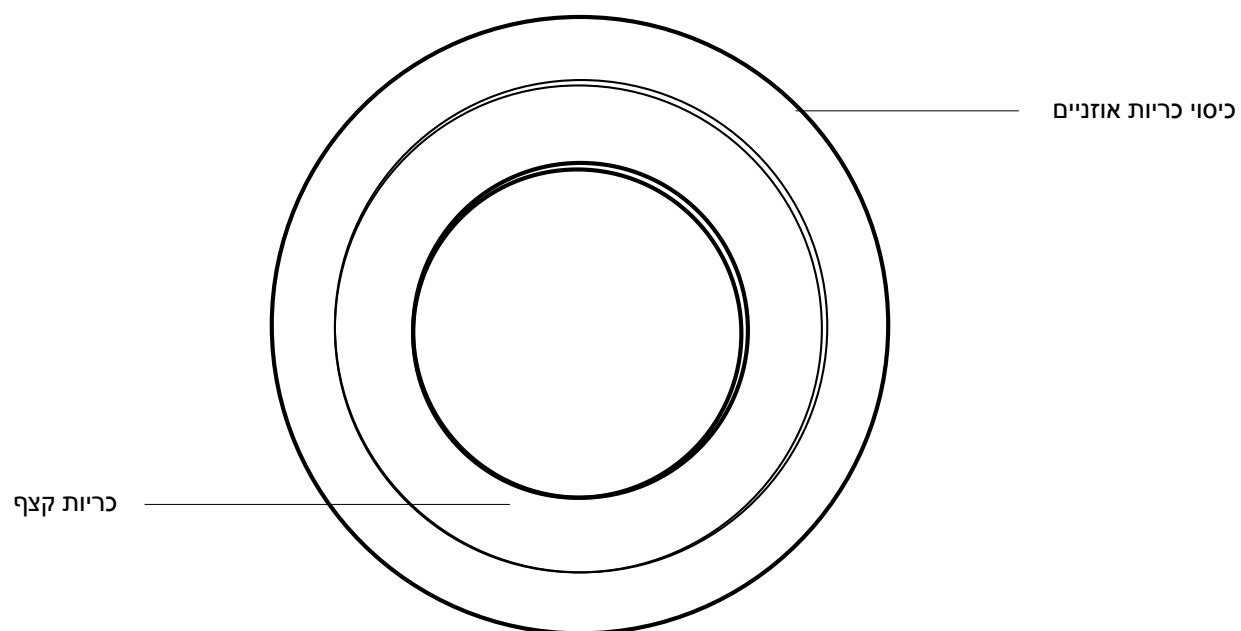

מה בקופסה?

1. זוג אחד (שתי יחידות) של כיסוי אוזניה מתחלף
2. זוג אחד (שתי יחידות) של כריות קצף
3. זוג אחד (שתי יחידות) של סרטים דביקים

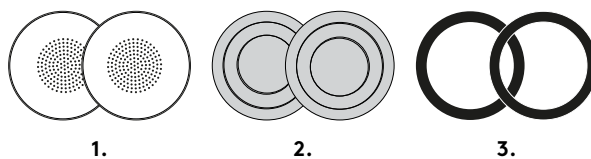

החלפת כיסוי כריות האוזניים

1. הסר את כיסוי כריות האוזניים הקיים על ידי צביטה עדינה של הכיסוי.

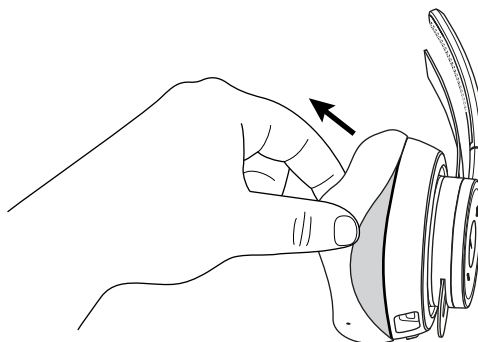

2. הסר בעדינות את כיסוי כריות האוזניים עד אשר יוסר לחלוטין.

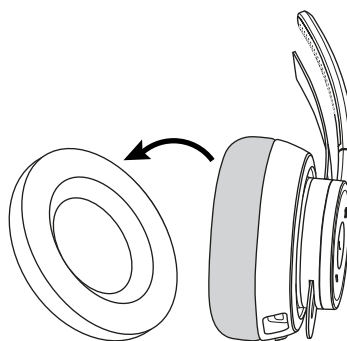

וודא לא לצבוט את כרית הקצף, אשר עלולה להינזק בקלות.

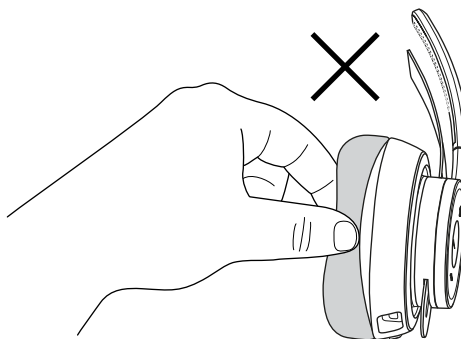

3. אם כרית הקצף פגומה, אנא בצע את השלבים הבאים.
 a. קלף את כרית הקצף והחלף בחדשה.

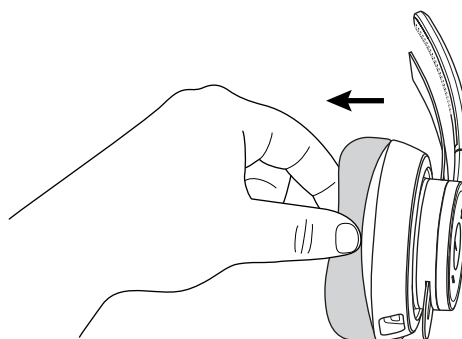

b. מקם תחילה את הדבק בחלק העליון של האפרכסת.

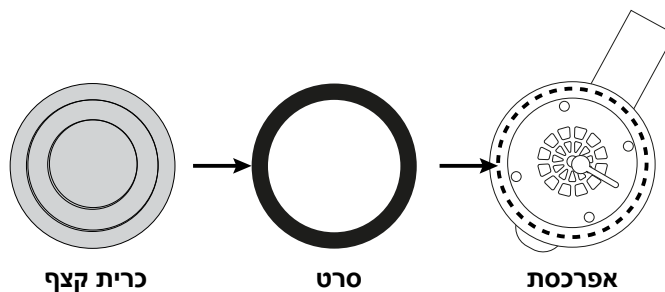

c. לאחר מכן, הצמד את כרית הקצף לסרט.

4. אחוז בכיסוי כריות האוזניים החדש, וודא כי החורים הקטנים בצד מיושרים אל מול החלק העליון והתחתון של האפרכסת. היא צריכה להתיישר עם יציאת USB-C בחלק התחתון.

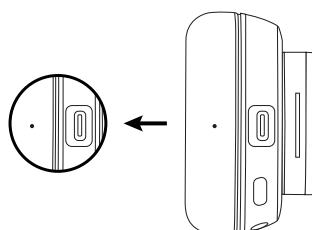

5. מהחלק העליון, חרוץ את קצה כיסוי כריות האוזניים פנימה לתוך המרווח. הנח את קצה הכיסוי במרווח מסביב לאפרכסת.

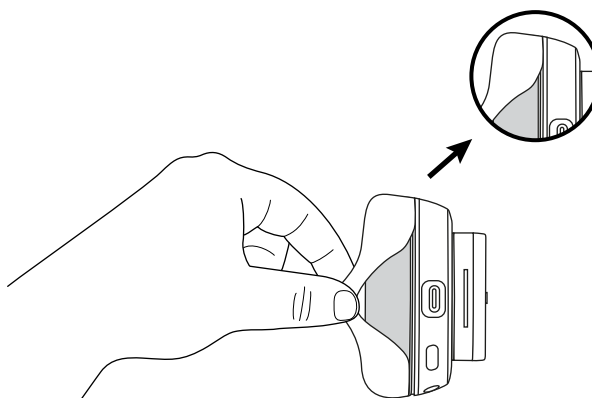

6. לאחר השלמת התהליך, טפח מספר פעמים בעדינות על האפרכסת על מנת לדחוף את האויר החוצה.

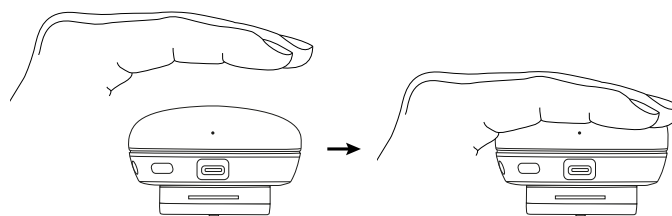

מידות

כיסויי כריות אוזניים

גובה x רוחב x עומק: 70.7 מ"מ x 70.7 מ"מ x 16.4 מ"מ

www.logitech.com/support/zone-wireless-earpad-covers