

# LOGITECH ZONE WIRED

Setup Guide  
设置指南

完整設定指南  
설치 가이드

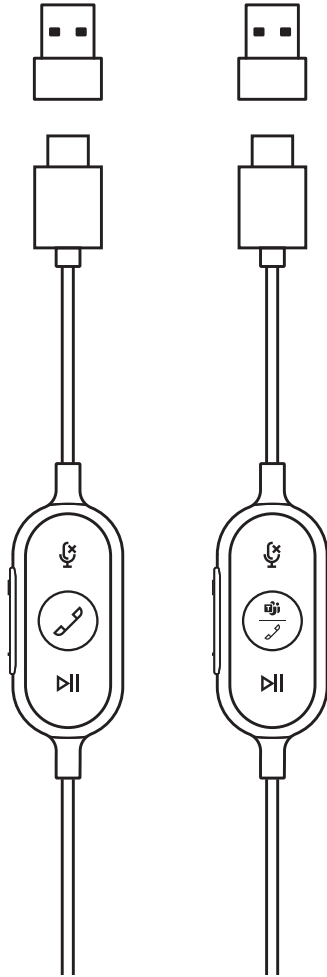
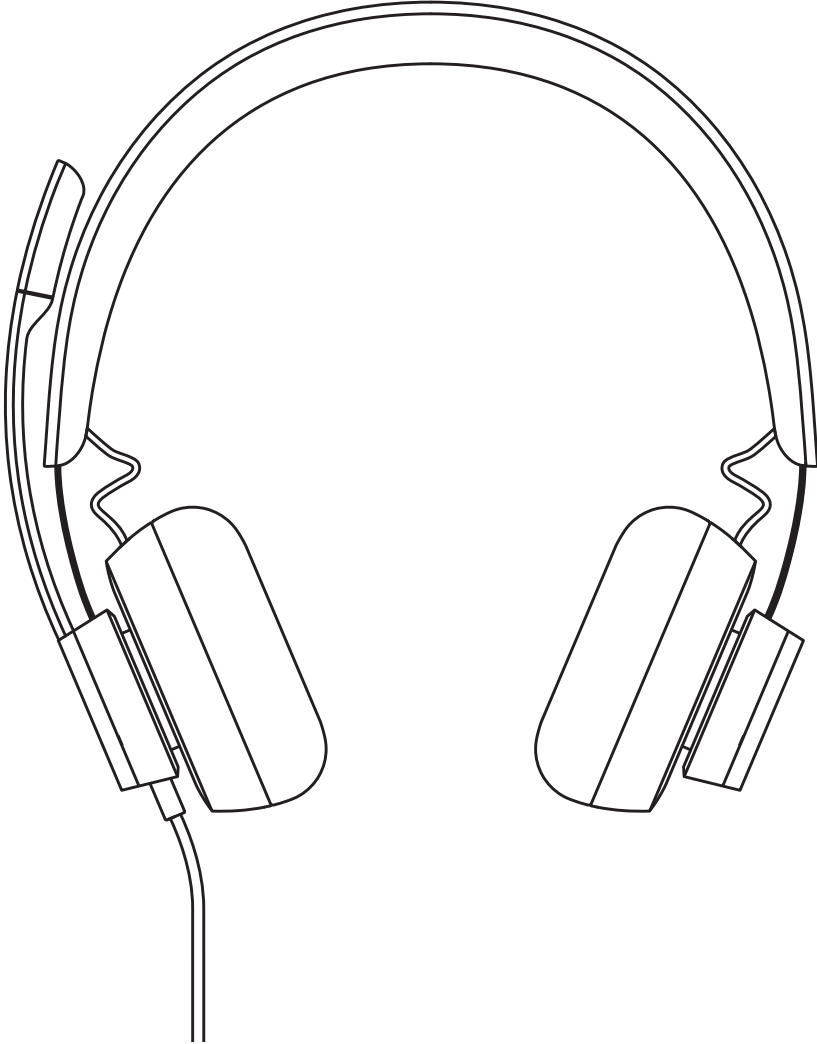

UNIFIED  
COMMUNICATIONS  
(UC) VERSION

MICROSOFT  
TEAMS VERSION

English . . . . .3

简体中文 . . . . . 10

繁體中文 . . . . . 18

한국어. . . . . 26

# KNOW YOUR PRODUCT



# IN-LINE CONTROLLER

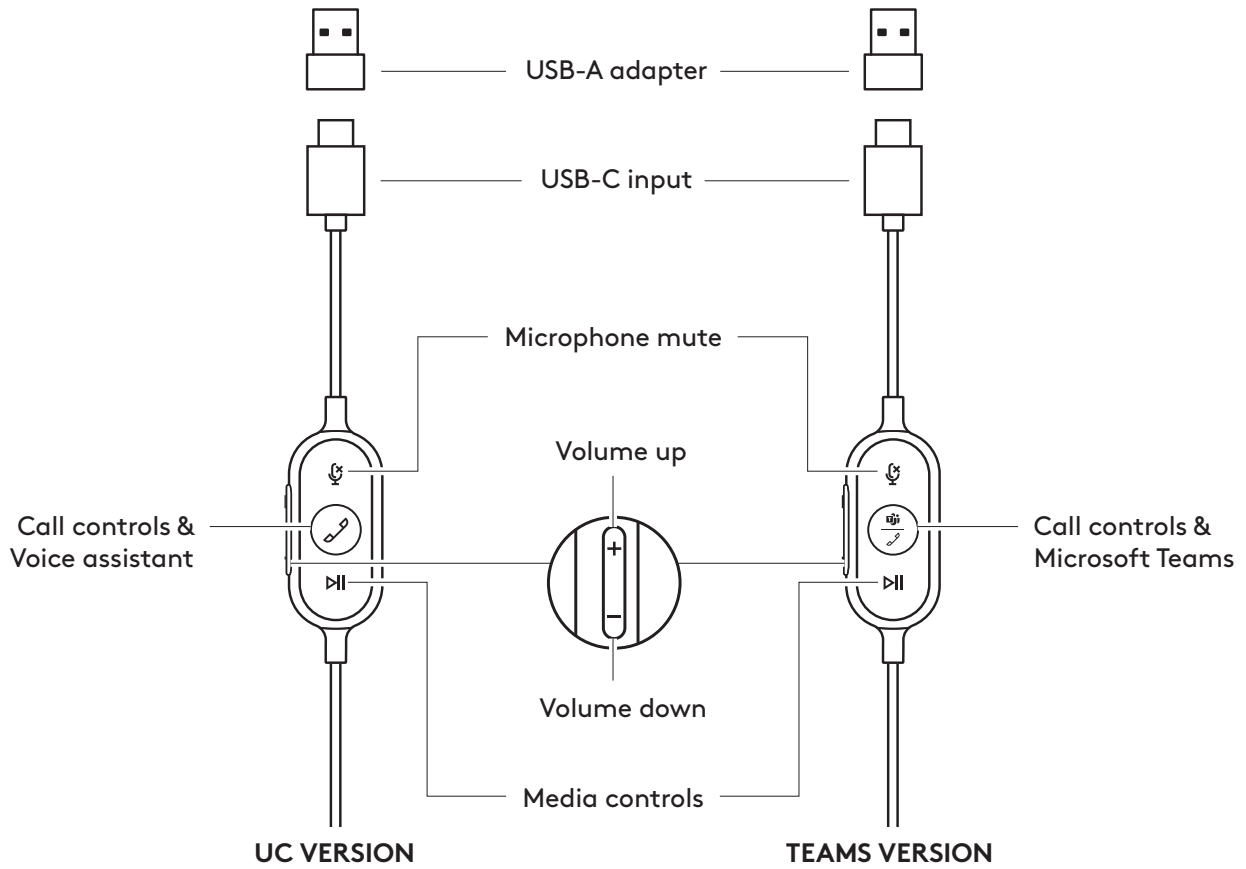

## WHAT'S IN THE BOX

1. Headset with In-line controller and USB-C connector
2. USB-A adapter
3. Travel bag
4. User documentation

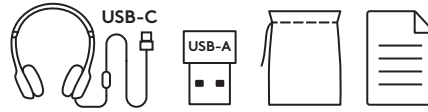

## CONNECTING THE HEADSET

Connect via USB-C

1. Plug the USB-C connector into your computer USB-C port.

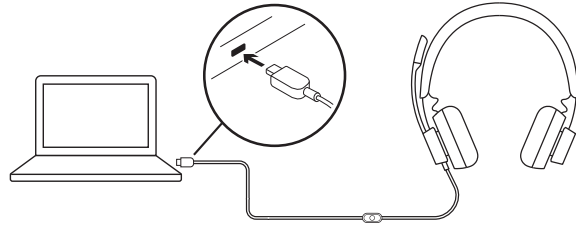

Connect via USB-A

1. Plug the USB-C connector into the USB-A adapter.
2. Plug the USB-A connector into your computer USB-A port.

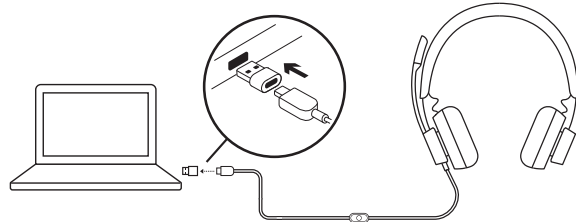

## HEADSET FIT

Adjust headset by sliding headband open or closed on both sides.

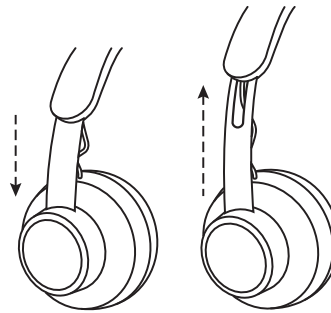

## ADJUSTING THE MICROPHONE BOOM

1. Microphone boom rotates 270 degrees. Wear it on either left or right side. To activate audio channel switching, download Logi Tune Desktop at: [www.logitech.com/support/zonewireddownloads](http://www.logitech.com/support/zonewireddownloads).
2. Adjust flexible microphone boom location to capture voice better.

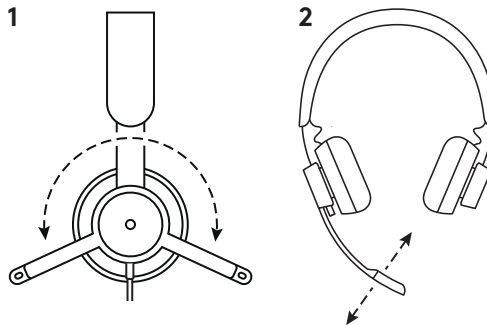



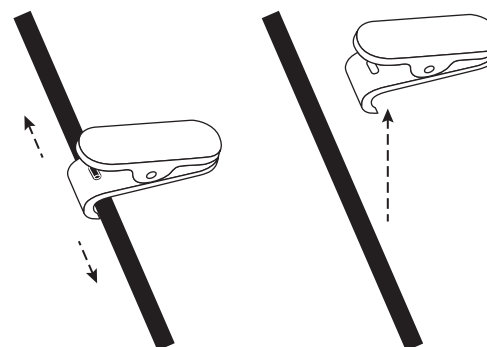

## ADJUSTABLE SHIRT CLIP

Secure the cable to your clothing with the shirt clip or remove it if you prefer.





## HEADSET IN-LINE CONTROLS AND INDICATOR LIGHT

TEAMS version				
Button	Usage	Indicator Light	Action	
	<b>Mute</b>	Mute on	Solid RED	Short press to Mute / Unmute
		Mute off	No light	
 	<b>Call Controls</b>	Incoming calls	Flashing WHITE	Short press to Answer calls
		Ongoing calls	Solid WHITE	2 second press to Reject calls
	<b>Teams Activities</b>	Connecting to Teams	Pulsing PURPLE	Short press to check connection to Teams
		Failed connection to Teams	Flashing PURPLE for 10 secs then off	
		Not connected to Teams	Flashing PURPLE 3 times then off	
		Connected to Teams	Solid PURPLE	Short press to Quickly access Teams
Teams Missed call / Voice mail / Join meeting notifications	Pulsing PURPLE	2 second press to Trigger Teams voice skills (Cortana)		
	<b>Media Controls</b>	No light	Short press to Play / Pause	
			Double press to Track forward	
			Triple press to Track backward	
<b>+</b>	<b>Volume</b>	No light	Short press to Volume up	
<b>-</b>			Short press to Volume down	

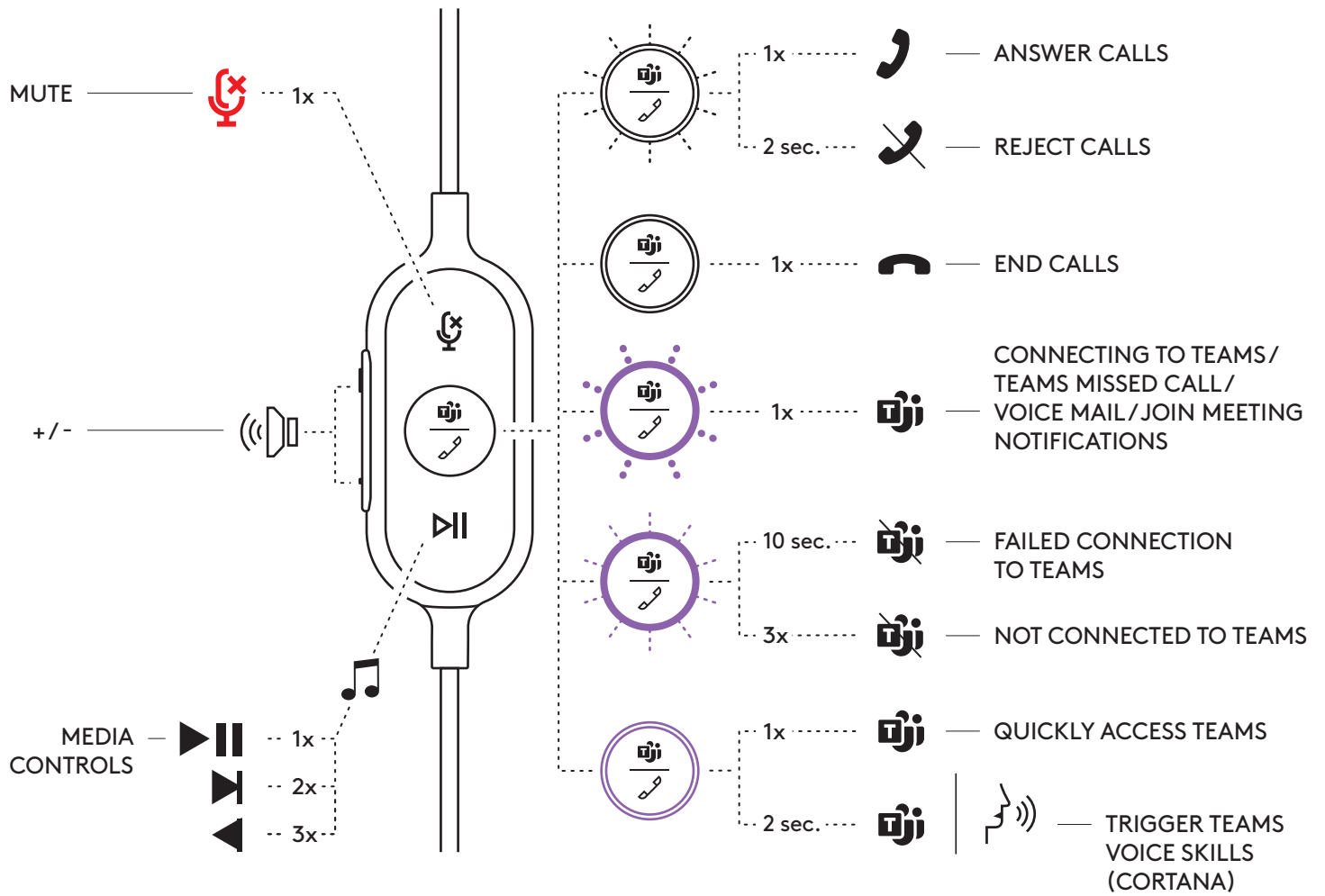
**Note:** Teams activities are only functional when Teams is running on unlocked PC or Mac.



UC version				
Button	Usage	Indicator Light	Action	
	<b>Mute</b>	Mute on	Solid RED	Short press to Mute / Unmute
		Mute off	No light	
	<b>Call Controls</b>	Incoming calls	Flashing WHITE	Short press to Answer calls
		Ongoing calls	Solid WHITE	Short press to End calls
	<b>Voice Assistant</b>	No light	2 second press to Trigger voice assistant*	
	<b>Media Controls</b>	No light	Short press to Play / Pause	
		No light	Double press to Track forward	
		No light	Triple press to Track backward	
+	<b>Volume</b>	No light	Short press to Volume up	
-			Short press to Volume down	

\*Voice assistant functionality may depend on device models.

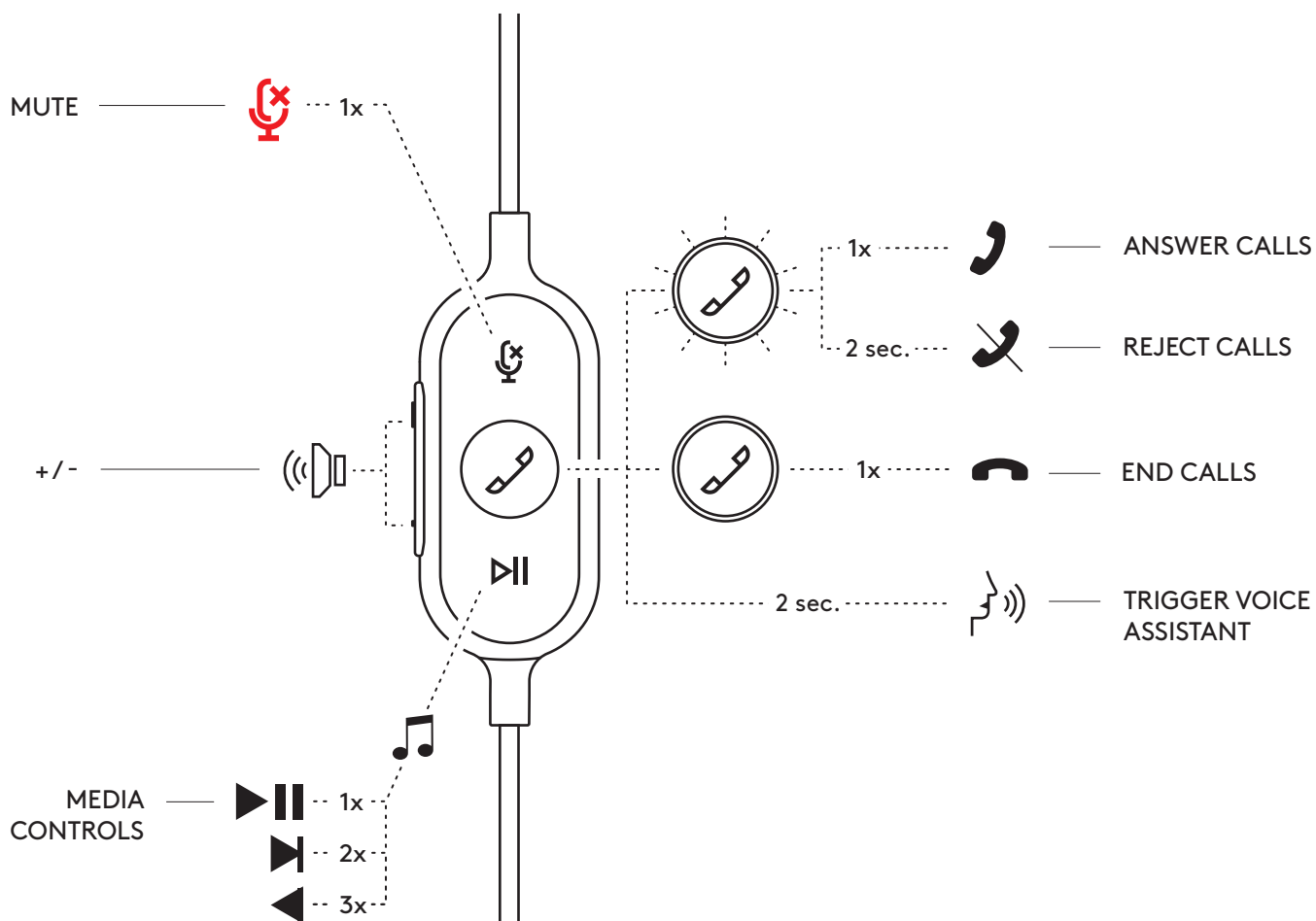

## LOGI TUNE DESKTOP (PC COMPANION APP)

Logi Tune Desktop helps boost your headset performance with periodic software and firmware updates, helps you adjust what you hear with 5 band EQ customization, and helps you control how you are heard with mic gain, sidetone controls, and more. The distraction-free mini-app allows you to make audio adjustments while in an active video call.

Learn more & download Logi Tune Desktop at: [www.logitech.com/LogiTune](http://www.logitech.com/LogiTune)

### NAVIGATE LOGI TUNE HEADSET SOUND

1. Adjust mic gain to modify the loudness of your voice on calls.
2. Adjust sidetone to better hear your own voice while on calls.
3. Adjust the equalizer with presets tuned for different music types or create custom EQ settings.
4. Run headset test on your speaker, mic and internet connection. The test summary will help with system fix tools for driver and OS related issues only.
5. Notification for software updates. Tap to accept.

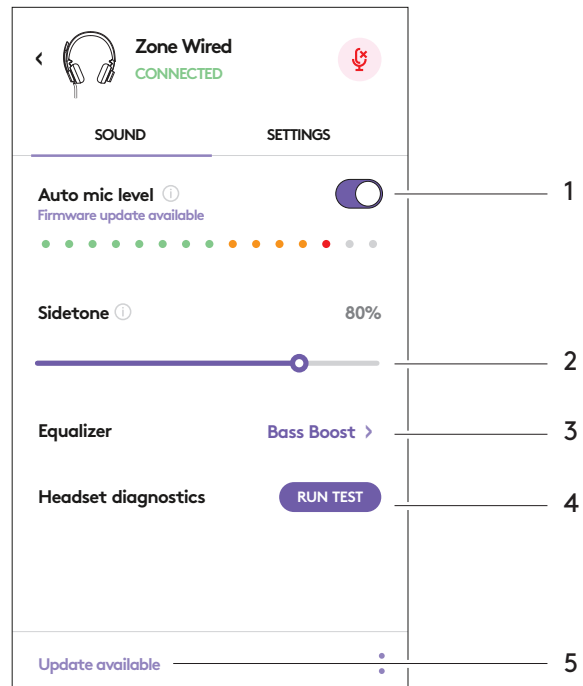

### NAVIGATE LOGI TUNE HEADSET SETTINGS

1. About headset > will give a summary of your device details and firmware information.
2. Control voice prompt.
3. Control flip to mute.
4. Auto app update - Activate to run updates in the background so that your app will always be up to date.
5. App notification control.

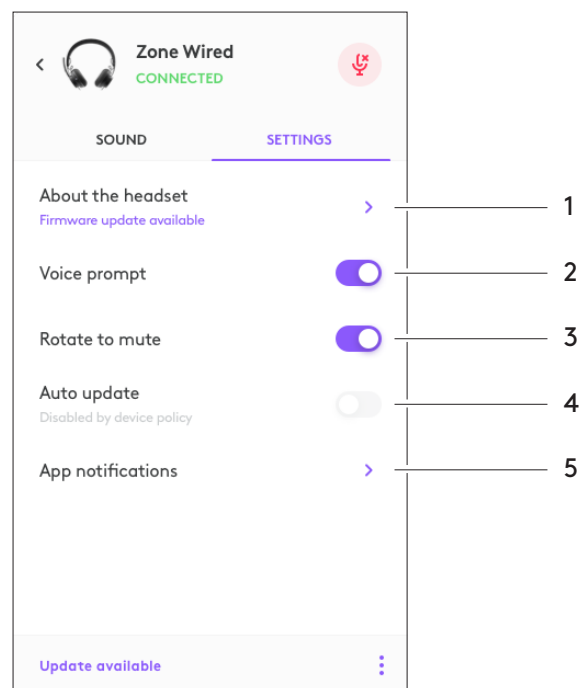

Learn more about Tune for Enterprise mass deployment and configuration at: [www.logitech.com/logitune](http://www.logitech.com/logitune)



## **DIMENSION**

### **Headset:**

Height x Width x Depth: 165.93mm x 179.73mm x 66.77mm

Weight: 0.211 Kg

### **Ear pad dimensions:**

Height x Width x Depth: 65.84mm x 65.84mm x 18.75mm

### **Adapter:**

Height x Width x Depth: 21.5mm x 15.4mm x 7.9mm

## **SYSTEM REQUIREMENTS**

Windows or Mac based computer with available USB-C or USB-A port.

## **TECHNICAL SPECIFICATIONS**

Input Impedance: 32 Ohms

Sensitivity (headphone): 99dB±3dB at 1000Hz @30mW,1cm

Sensitivity (microphone): Main mic: -48 dBV/Pa, Secondary mic: - 40 dBV/Pa

Frequency response (Headset): 20~16 kHz

Frequency response (Microphone): 100~16 kHz

Cable length: 1.9 m

# LOGITECH ZONE WIRED

## 设置指南

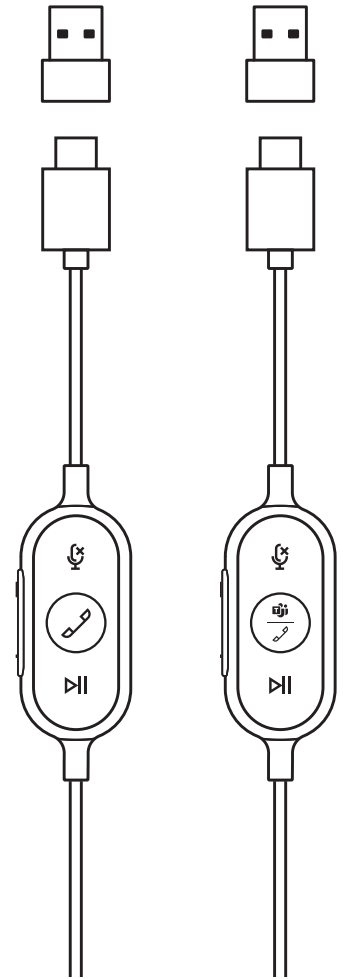

统一通讯  
(UC) 版

MICROSOFT  
TEAMS 版

## 了解您的产品



## 线控

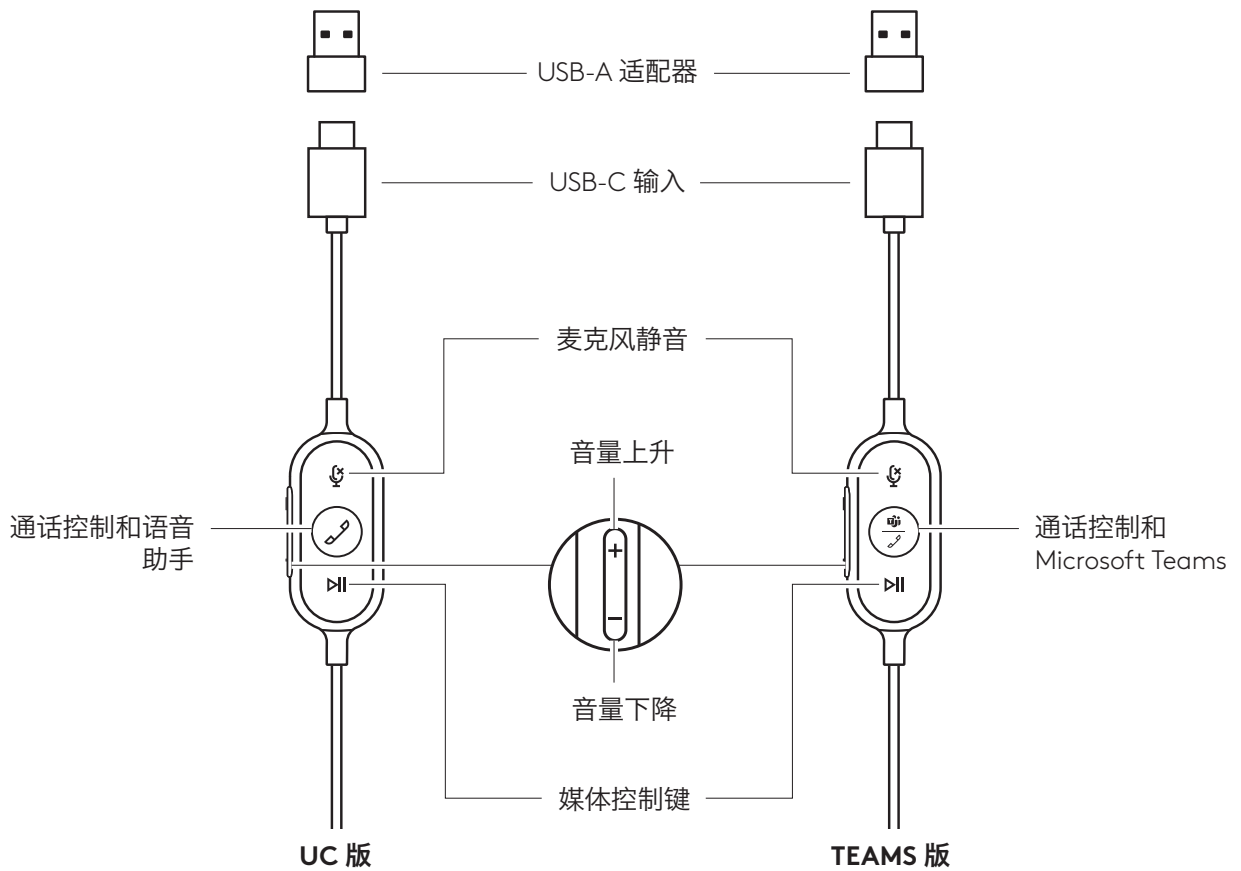

## 包装内容

1. 带线控和 USB-C 接头的耳机麦克风
2. USB-A 适配器
3. 便携包
4. 用户文档

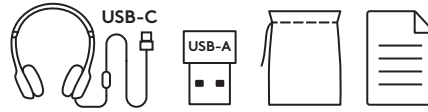

## 连接耳机麦克风

通过 USB-C 连接

1. 将 USB-C 接头插入电脑的 USB-C 端口。

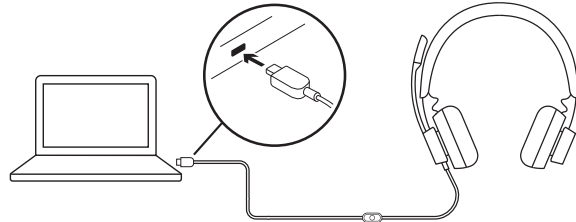

通过 USB-A 连接

1. 将 USB-C 接头插入 USB-A 适配器。
2. 将 USB-A 接头插入电脑的 USB-A 端口。

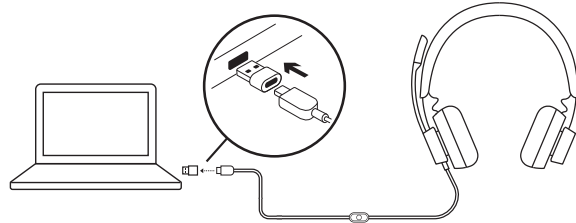

## 耳机麦克风贴合佩戴

滑动两侧头带调节耳机麦克风。

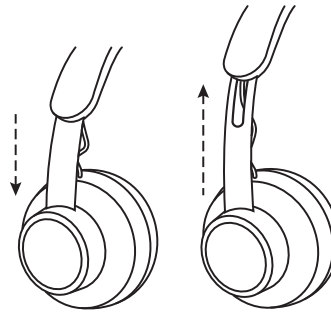

## 调整麦克风杆

1. 麦克风杆可旋转 270 度。可将其佩戴于左侧或右侧。要激活音频频道切换，请在以下位置下载 Logi Tune 桌面版：  
[www.logitech.com/support/zonewireddownloads](http://www.logitech.com/support/zonewireddownloads)。
2. 调整灵活麦克风杆位置，以更好地捕捉声音。

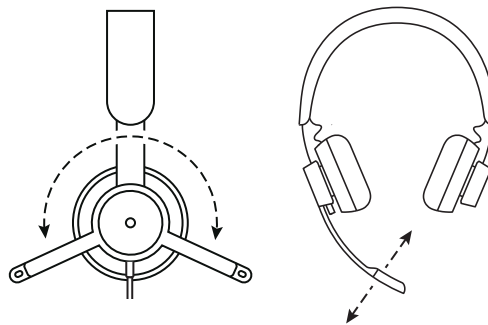

## 可调节衬衫夹

用衬衫夹将线缆固定到衣服上，或者根据需要将其卸下。

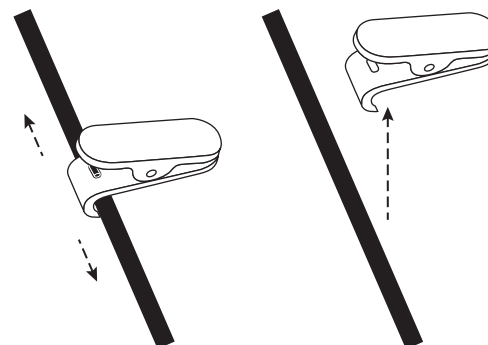

## 耳机麦克风线控和指示灯

TEAMS 版				
按钮	使用		指示灯	操作
	静音	开启静音	常亮红色	短按静音/取消静音
		取消静音	无指示灯	
	通话控制	通话呼入	闪烁白色	短按接听通话 按住 2 秒拒绝通话
		通话中	常亮白色	短按结束通话
	Teams 行为	正在连接 Teams	闪烁紫色	短按检查与 Teams 的连接
		连接 Teams 失败	闪烁紫色 10 秒后熄灭	
		未连接 Teams	闪烁紫色 3 次后熄灭	
		已连接 Teams	常亮紫色	短按快速访问 Teams 按住 2 秒触发 Teams 语音功能 (Cortana)
		Teams 未接通话/语音邮件/ 加入会议通知	闪烁紫色	短按回应 Teams 通知
	媒体控制		无指示灯	短按播放/暂停
				按两次前进
				按三次后退
+	音量	无指示灯		短按音量上升
				-

**请注意：**仅当 Teams 运行于未锁定的 PC 或 Mac 上时，Teams 行为才有效。

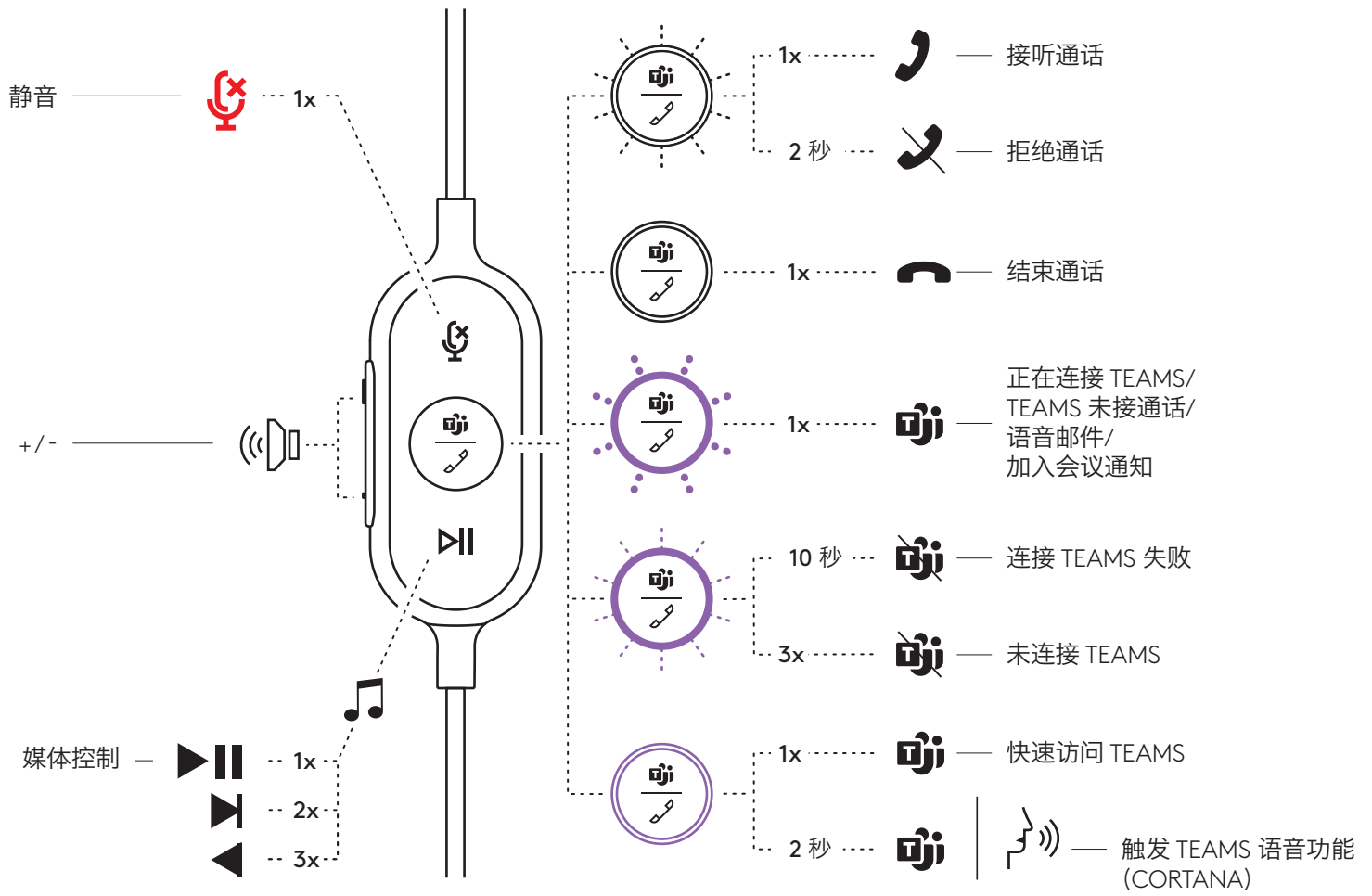

UC 版				
按钮	使用		指示灯	操作
	静音	开启静音	常亮红色	短按静音/取消静音
		取消静音	无指示灯	
	通话控制	通话呼入	闪烁白色	短按接听通话
		通话中	常亮白色	短按结束通话
	语音助手		无指示灯	按住 2 秒触发语音助手*
	媒体控制		无指示灯	短按播放/暂停
				按两次前进
				按三次后退
+	音量		无指示灯	短按音量上升
-		短按音量下降		

\*语音助手功能可能取决于设备型号。

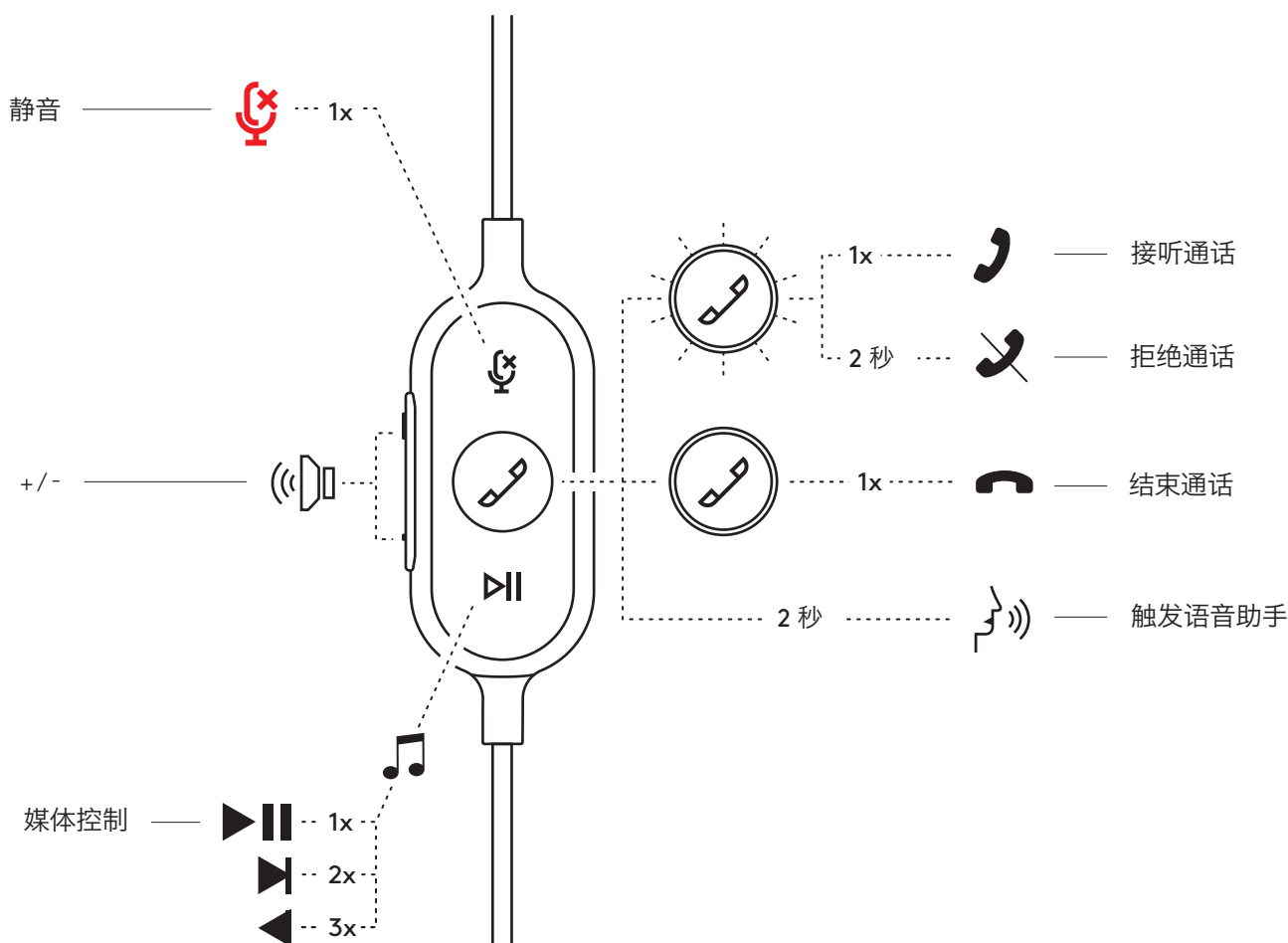

## LOGI TUNE 桌面版 (PC 配套应用程序)

Logi Tune 桌面版通过定期的软件和固件更新来帮助提高耳机麦克风性能，通过 5 频段均衡器自定义帮助您调节声音，并通过麦克风增益、侧音控制等功能控制声音。免干扰的迷你应用程序让您可以在进行视频通话时调整音频。

了解更多和下载 Logi Tune 桌面版：  
[www.logitech.com/LogiTune](http://www.logitech.com/LogiTune)

### 导航 LOGI TUNE 耳机麦克风声音

1. 调整麦克风增益，改变通话中声音的响度。
2. 调整侧音，以便在通话时更好地听到自己的声音。
3. 使用针对不同音乐类型调整的预设来调节均衡器，或者创建自定义均衡器设置。
4. 在扬声器、麦克风和互联网连接上运行耳机麦克风测试。该测试摘要将仅针对与驱动程序和操作系统相关的问题提供系统修复工具。
5. 软件更新通知。点击接受。

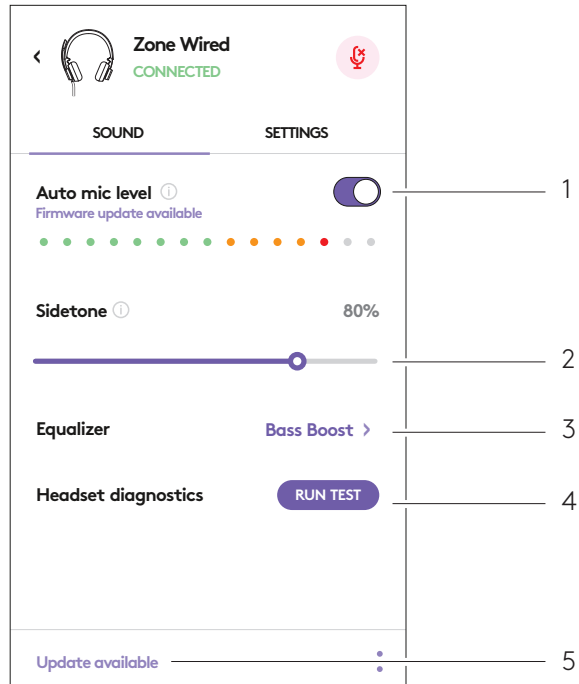

### 导航 LOGI TUNE 耳机麦克风设置

1. 关于耳机麦克风 > 将提供设备详细信息和固件信息的摘要。
2. 控制语音提示。
3. 控制翻转静音。
4. 自动更新应用程序 - 激活后可在后台运行更新，保持您的应用程序始终是最新状态。
5. 应用程序通知控制。

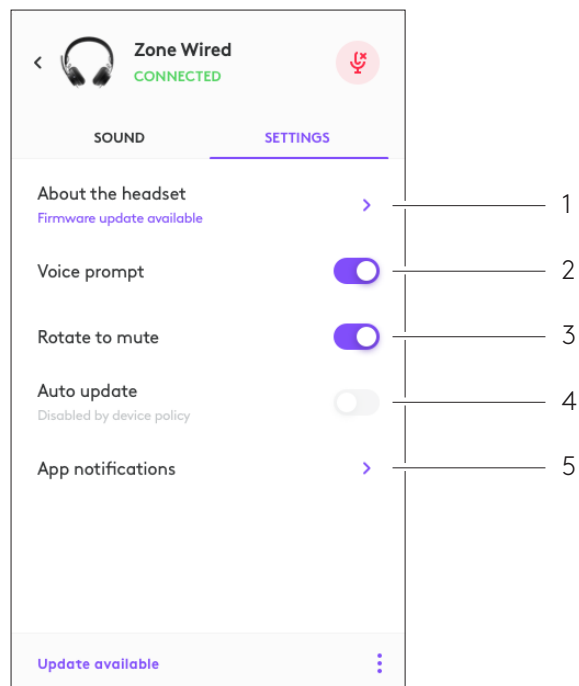

了解有关 Tune 企业版大规模部署和配置的更多信息，请访问：  
[www.logitech.com/logitune](http://www.logitech.com/logitune)



## 尺寸

耳机麦克风:

高 x 宽 x 深: 165.93 毫米 x 179.73 毫米 x 66.77 毫米

重量: 0.211 千克

耳罩尺寸:

高 x 宽 x 深: 65.84 毫米 x 65.84 毫米 x 18.75 毫米

适配器:

高 x 宽 x 深: 21.5 毫米 x 15.4 毫米 x 7.9 毫米

## 系统要求

配备可用 USB-C 或 USB-A 端口的 Windows 或 Mac 电脑。

## 技术规格

输入阻抗: 32 欧姆

灵敏度 (耳机麦克风): 99dB±3dB @ 1000Hz @30mW, 1 厘米

灵敏度 (麦克风): 主麦克风: -48 dBV/Pa, 副麦克风: -40 dBV/Pa

频率响应 (耳机麦克风): 20~16 kHz

频率响应 (麦克风): 100~16 kHz

线缆长度: 1.9 米

# LOGITECH ZONE WIRED

## 設定指南



整合通訊  
(UC) 版本



MICROSOFT  
TEAMS 版本

## 瞭解您的產品

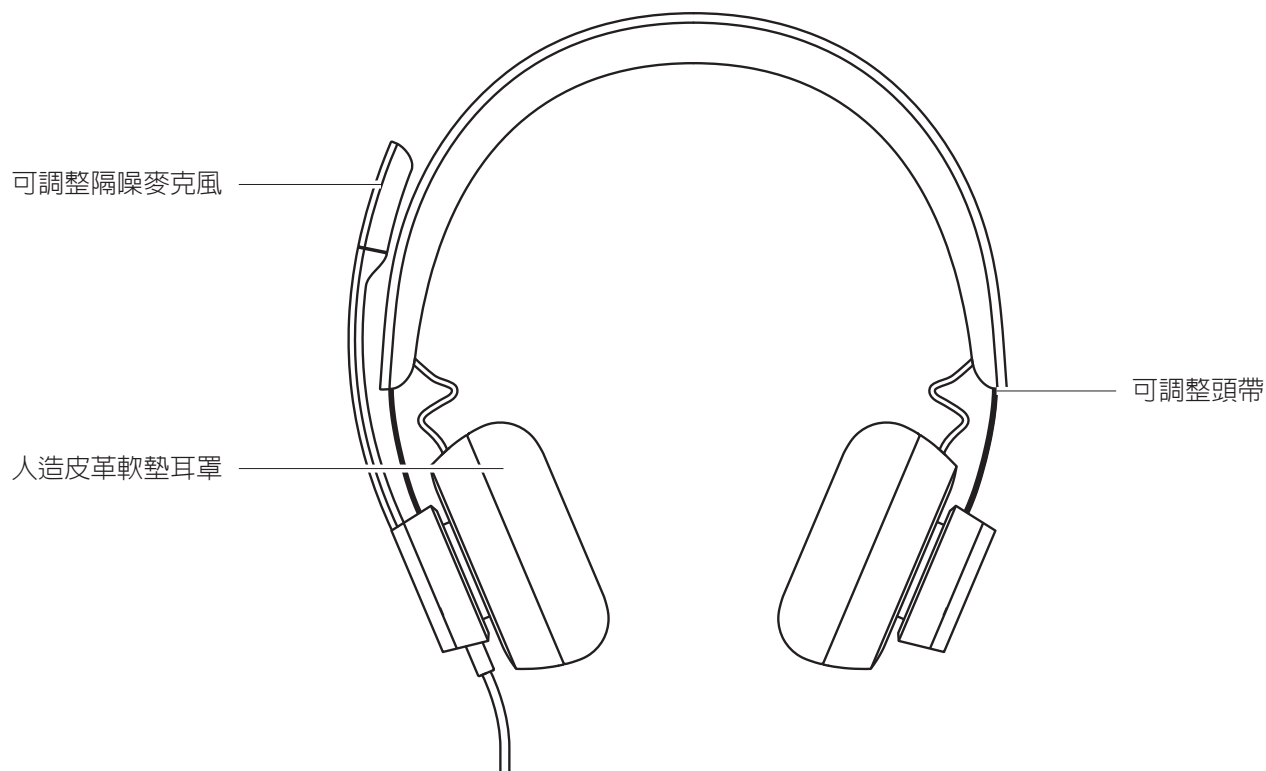

## 線控裝置

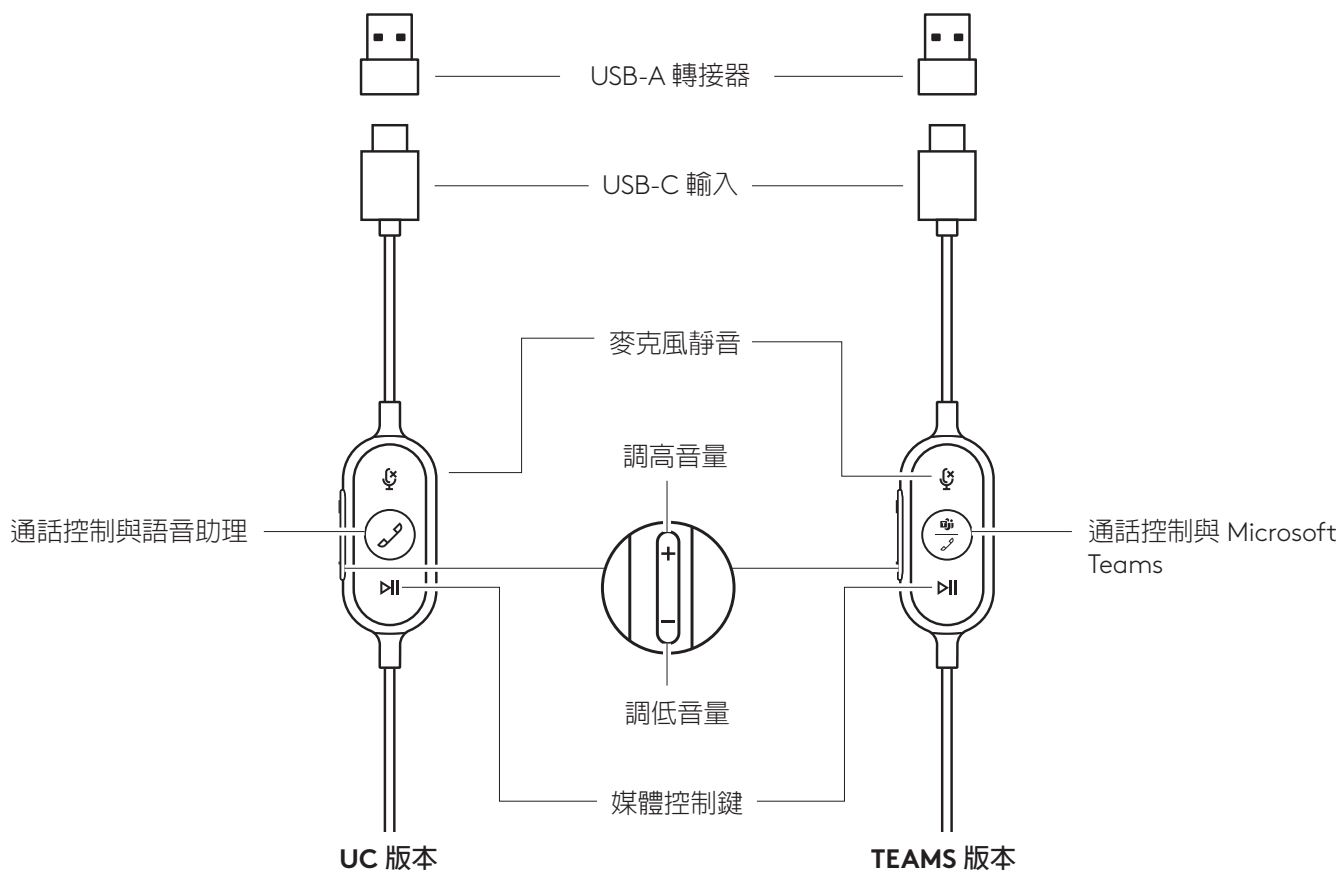

## 包裝內容

1. 具備線控裝置和 USB-C 接頭的耳機麥克風
2. USB-A 轉接器
3. 攜行袋
4. 使用者文件

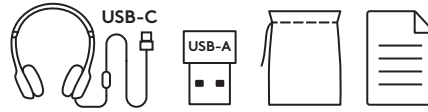

## 連接耳機麥克風

透過 USB-C 連接

1. 將 USB-C 接頭插入您電腦的 USB-C 連接埠。

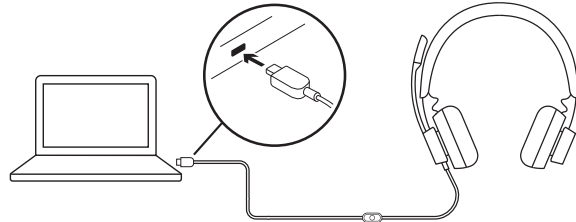

透過 USB-A 連接

1. 將 USB-C 接頭插入 USB-A 轉接器。
2. 將 USB-A 接頭插入您電腦的 USB-A 連接埠。

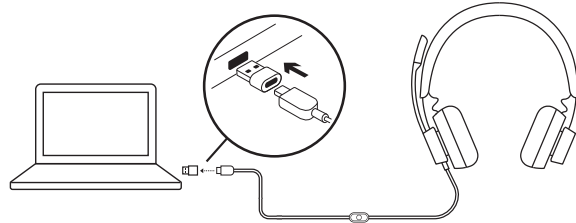

## 耳機麥克風配戴

透過滑動兩側頭帶使其開啓或關閉來調整耳機麥克風。

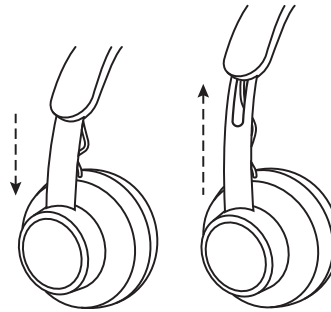

## 調整麥克風桿。

1. 麥克風桿可旋轉 270 度。可將其配戴在左側或右側。若要啓用音訊頻道切換，請到下列網址下載 Logi Tune Desktop：  
[www.logitech.com/support/zonewireddownloads](http://www.logitech.com/support/zonewireddownloads).
2. 彈性調整麥克風桿位置以更好地擷取聲音。

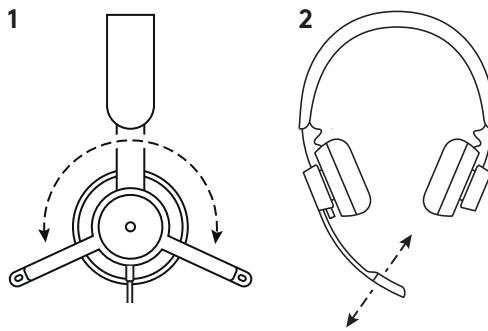

## 可調整衣夾

利用衣夾將連接線穩固夾在衣服上，或者您喜歡的話也可將其取下。

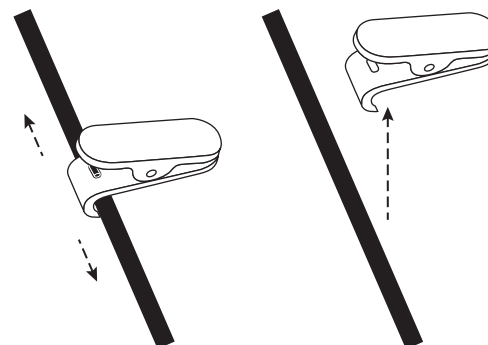



## 耳機麥克風線控裝置指示燈

TEAMS 版本				
按鈕	用途		指示燈	行動
	靜音	靜音開啟	穩定紅燈	短按靜音 / 取消靜音
		靜音關閉	無指示燈	
 	通話控制	來電	閃爍白燈	短按接聽通話 按下 2 秒可掛斷來電
		通話中	穩定白燈	短按結束通話
	Teams 活動	正在連線到 Teams	閃爍紫燈	短按檢查與 Teams 的連線
		未能連線到 Teams	閃爍紫燈 10 秒然後熄滅	
		未連線到 Teams	閃爍紫燈 3 次然後熄滅	
		已連線到 Teams	穩定紫燈	短按快速存取 Teams 按下 2 秒可觸發 Teams 語音功能 (Cortana)
Teams 未接的通話 / 語音郵件 / 加入會議通知	閃爍紫燈	短按可回應 Teams 通知		
	媒體控制鍵		無指示燈	短按可播放/暫停
				按兩下可播放下一曲目
				按三下可播放上一曲目
+	音量		無指示燈	短按可增加音量
-				短按可減少音量

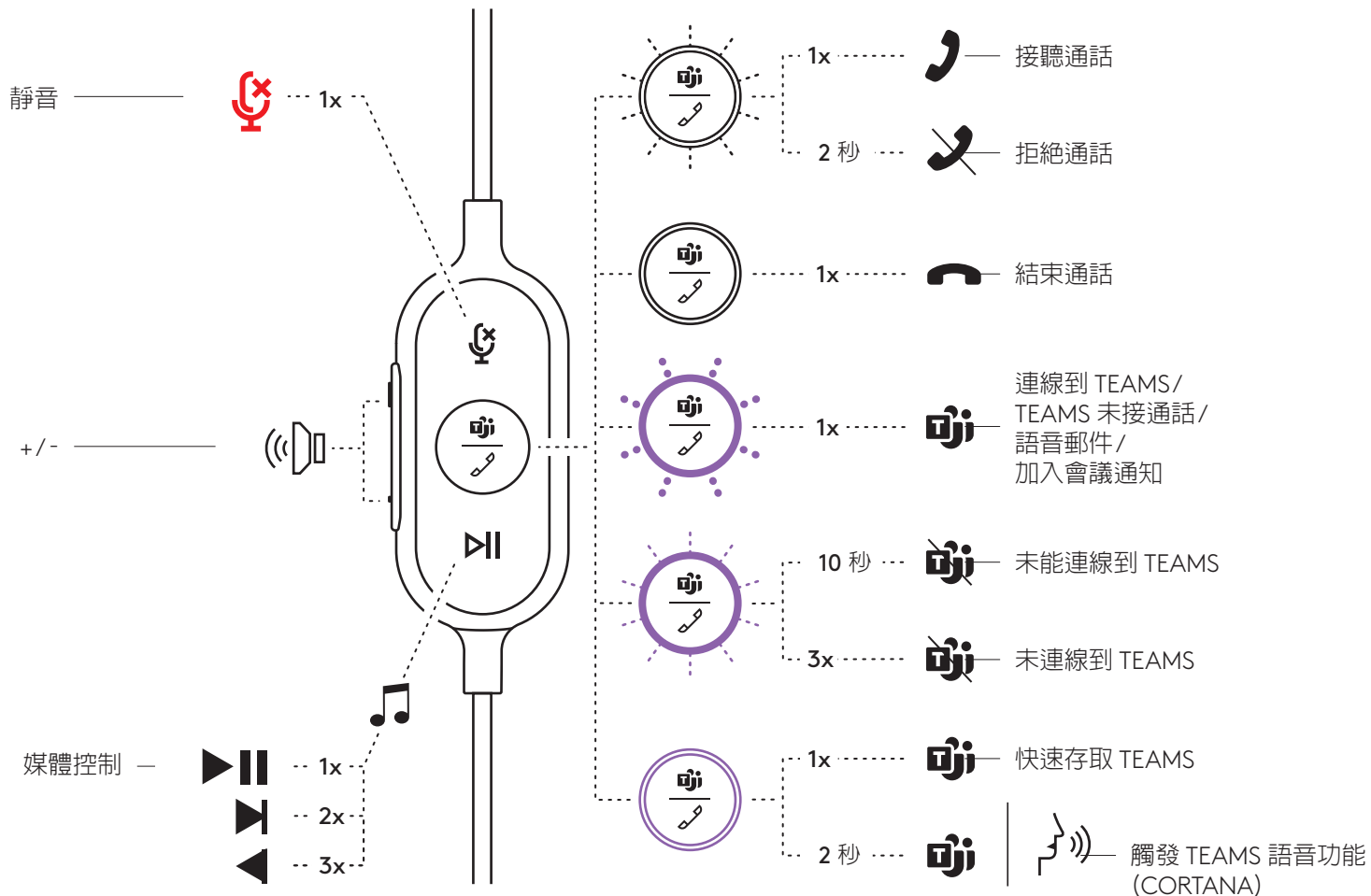
注意：Teams 活動僅在 Teams 正在未鎖定的 PC 或 Mac 上執行時可以使用。



UC 版本				
按鈕	用途		指示燈	行動
	靜音	靜音開啟	穩定紅燈	短按靜音 / 取消靜音
		靜音關閉	無指示燈	
	通話控制	來電	閃爍白燈	短按接聽通話
		通話中	穩定白燈	短按結束通話
	語音助理	無指示燈	按下 2 秒可觸發語音助理*	
	媒體控制鍵		無指示燈	短按可播放/暫停
				按兩下可播放下一曲目
				按三下可播放上一曲目
+	音量			短按可增加音量
-				短按可減少音量

\* 語音助理功能視裝置型號而定。

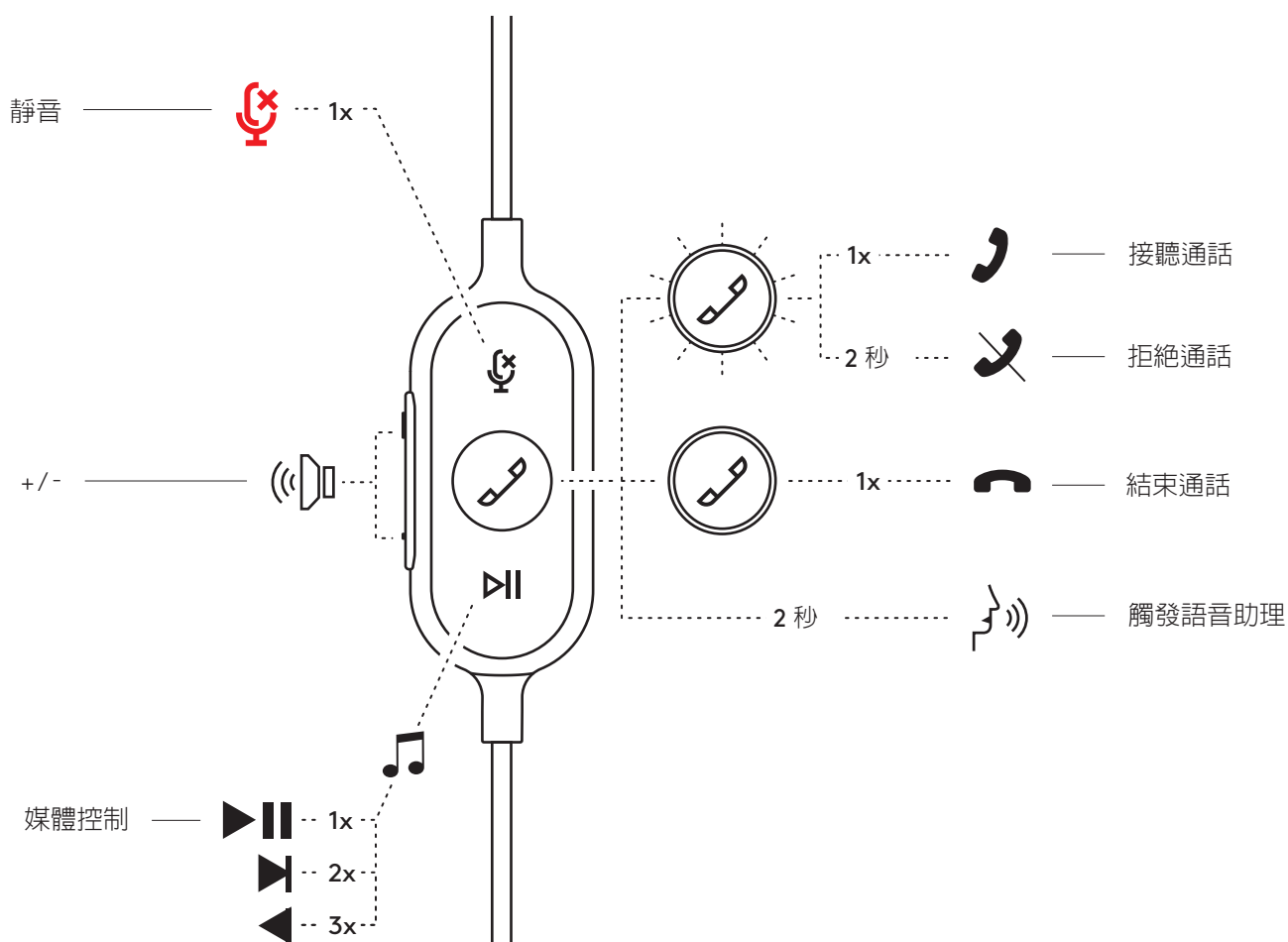

## LOGI TUNE DESKTOP (PC 伴隨應用程式)

Logi Tune Desktop 透過定期的軟體和韌體更新，協助提升您耳機麥克風的效能，透過 5 波段等化器自訂功能協助您調整所聽到的聲音，並透過麥克風增益、側音控制等協助您控制別人聽到之您聲音的品質。這個不會使人分心的免費迷你應用程式使您可以在有視訊通話進行時，可以同時執行音訊調整。

瞭解更多資訊並下載 Logi Tune Desktop：  
[www.logitech.com/LogiTune](http://www.logitech.com/LogiTune)

### 瞭解 LOGI TUNE HEADSET 聲音控制功能

1. 調整麥克風增益可修改您通話中語音的響亮程度。
2. 調整側音可讓別人在通話中更好地聽清您的聲音。
3. 調整針對不同音樂類型預先設定調校的等化器，或是建立自訂等化器設定。
4. 在您的音箱、麥克風或網際網路連線上執行耳機麥克風測試。測試摘要僅為對驅動程式的系統修復工具或作業系統相關問題提供協助。
5. 軟體更新通知。點按接受。

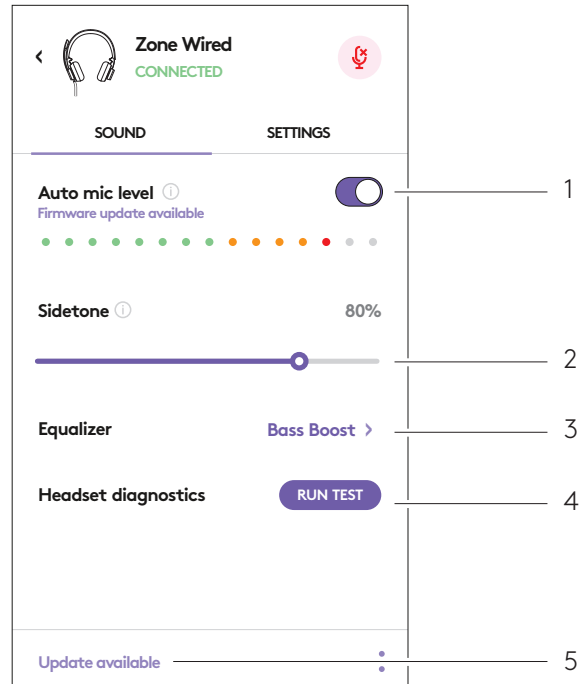

### 瞭解 LOGI TUNE HEADSET 設定

1. 關於耳機麥克風 > 提供您裝置詳細資料和韌體資訊的摘要。
2. 控制語音提示。
3. 控制翻轉靜音。
4. 自動更新應用程式 - 啟用此功能可在背景執行更新，使應用程式始終保持在最新狀態。
5. 應用程式通知控制。

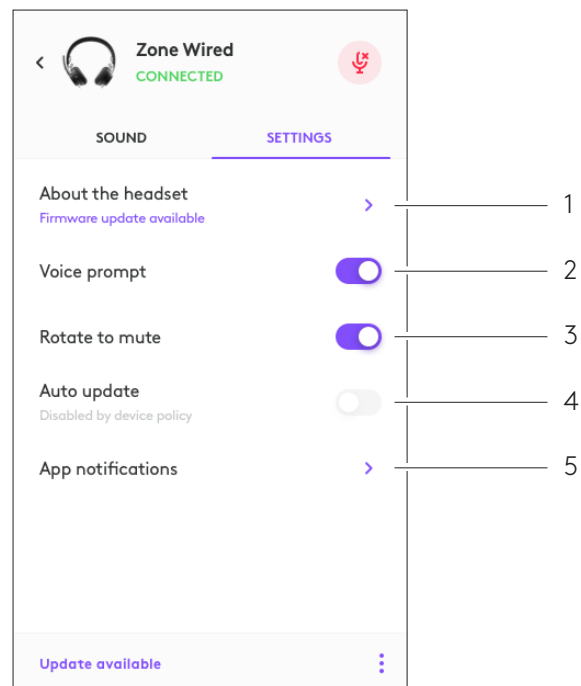

如要瞭解關於 Tune for Enterprise 大量部署與設定的更多資訊，請到：  
[www.logitech.com/logitune](http://www.logitech.com/logitune)



## 尺寸

耳機麥克風：

高 x 寬 x 深：165.93 公釐 x 179.73 公釐 x 66.77 公釐

重量：0.211 公斤

耳墊尺寸：

高 x 寬 x 深：65.84 公釐 x 65.84 公釐 x 18.75 公釐

轉接器：

高 x 寬 x 深：21.5 公釐 x 15.4 公釐 x 7.9 公釐

## 系統需求

具備可用的 USB-C 或 USB-A 連接埠的 Windows 或 Mac 電腦

## 技術規格

輸入阻抗：32 歐姆

耳機靈敏度：99dB±3dB at 1000Hz @30mW,1cm

麥克風靈敏度：主要麥克風：-48 dBV/Pa，次要麥克風：-40 dBV/Pa

耳機麥克風頻率響應：20~16 kHz

麥克風頻率響應：100~16 kHz

連接線長度：1.9 公尺

# LOGITECH ZONE WIRED

## 설치 가이드

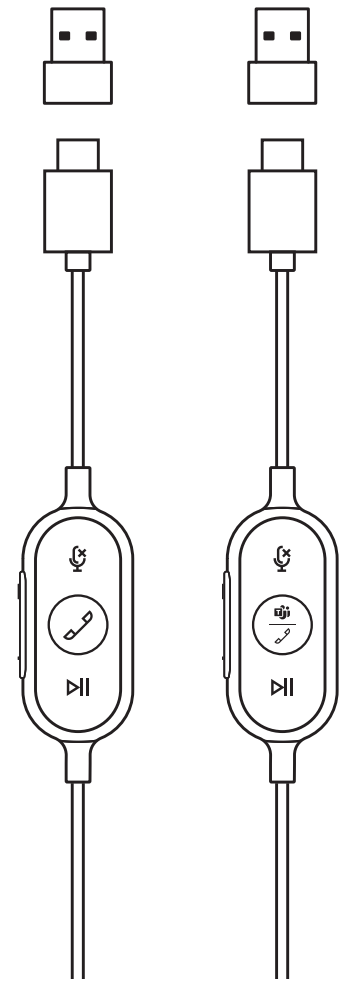

일반(UC) 버전

MICROSOFT  
TEAMS 버전

## 제품 설명



## 인라인 컨트롤러

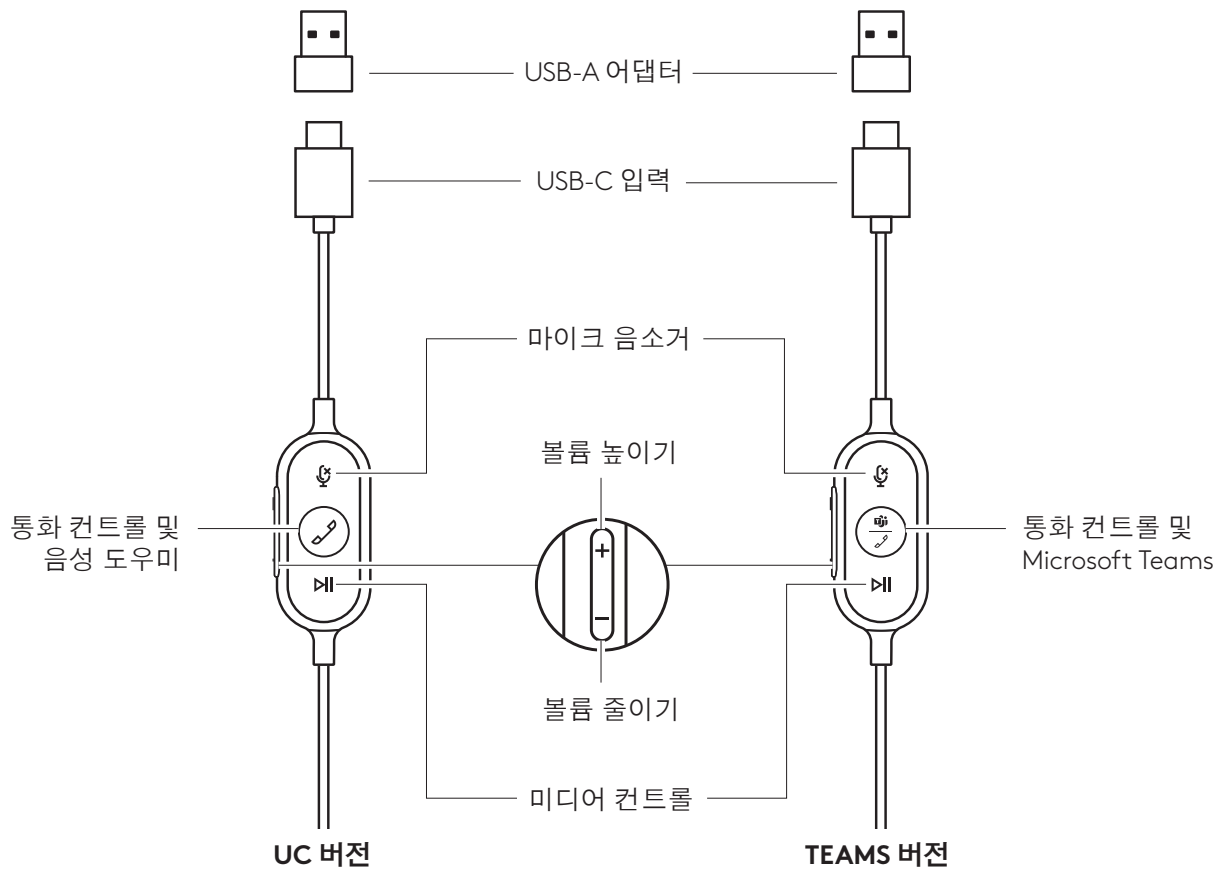

## 내용물

1. 인라인 컨트롤 및 USB-C 커넥터를 갖춘 헤드셋
2. USB-A 어댑터
3. 휴대용 가방
4. 사용 설명서

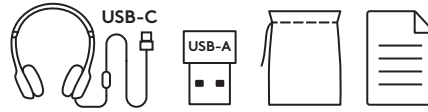

## 헤드셋 연결

### USB-C 연결

1. USB-C 커넥터를 컴퓨터 USB-C 포트에 연결합니다.

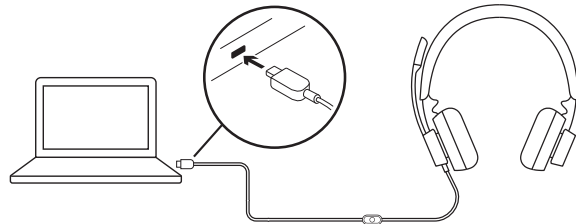

### USB-A 연결

1. USB-C 커넥터를 USB-A 어댑터에 연결합니다.
2. USB-A 커넥터를 컴퓨터 USB-A 포트에 연결합니다.

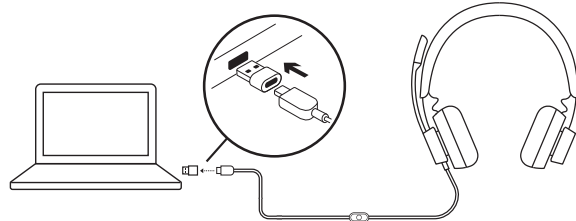

## 헤드셋 핏

헤드밴드의 양쪽을 슬라이드로 여닫아 헤드셋을 조절합니다.

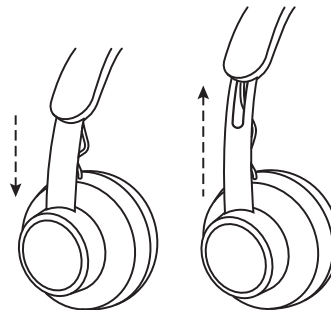

## 마이크 붐 조절

1. 마이크 붐은 270도 회전 가능합니다. 왼쪽 또는 오른쪽으로 착용할 수 있습니다. 오디오 채널 전환을 활성화하려면 다음 페이지에서 Logi Tune 데스크탑을 다운로드하십시오.  
[www.logitech.com/support/zonewireddownloads](http://www.logitech.com/support/zonewireddownloads).
2. 유연한 마이크 붐의 위치를 조절하면 목소리를 더 잘 들을 수 있습니다.

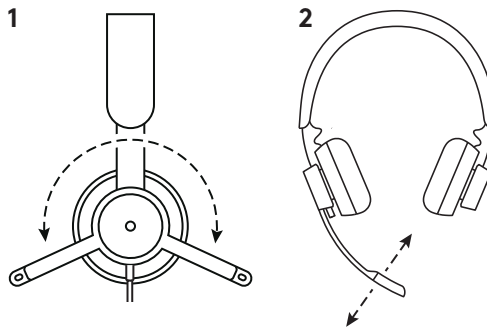

## 조절식 셔츠 클립

셔츠 클립으로 옷에 케이블을 고정하거나 필요에 따라 제거할 수 있습니다.

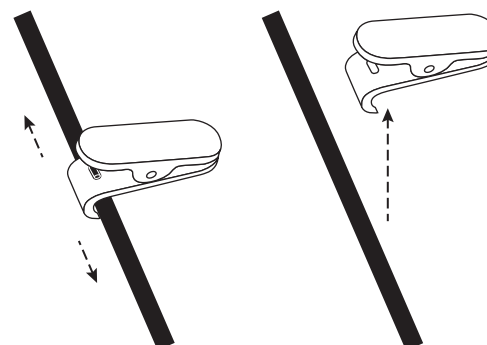

## 헤드셋 인라인 컨트롤 및 표시등

TEAMS 버전				
단추	용도		표시등	동작
	음소거	음소거 켜짐	빨간색으로 유지	짧게 눌러 음소거/음소거 해제
		음소거 꺼짐	불빛 없음	
	통화 제어	걸려온 통화	하얀색으로 깜박임	짧게 눌러 통화 응답
		진행 중인 통화	흰색으로 유지	2초간 눌러 통화 거부
	Teams 활동	Teams 연결	보라색으로 깜박임	짧게 눌러 Teams 연결 확인
		Teams 연결 실패	10초 동안 보라색으로 깜박인 뒤 꺼짐	
		Teams 연결되지 않음	보라색으로 3번 깜박인 뒤 꺼짐	
		Teams 연결됨	보라색으로 유지	
		Teams 부재중 전화/음성 메일/미팅 참가 알림	보라색으로 깜박임	
	미디어 컨트롤		불빛 없음	짧게 눌러 재생/일시 정지
				두 번 눌러 트랙 앞으로
				세 번 눌러 트랙 뒤로
	볼륨		불빛 없음	짧게 눌러 볼륨 높이기
				짧게 눌러 볼륨 줄이기

**참고:** Teams 활동은 잠겨 있지 않은 PC 또는 Mac에서 Teams를 사용 중일 때만 작동됩니다.

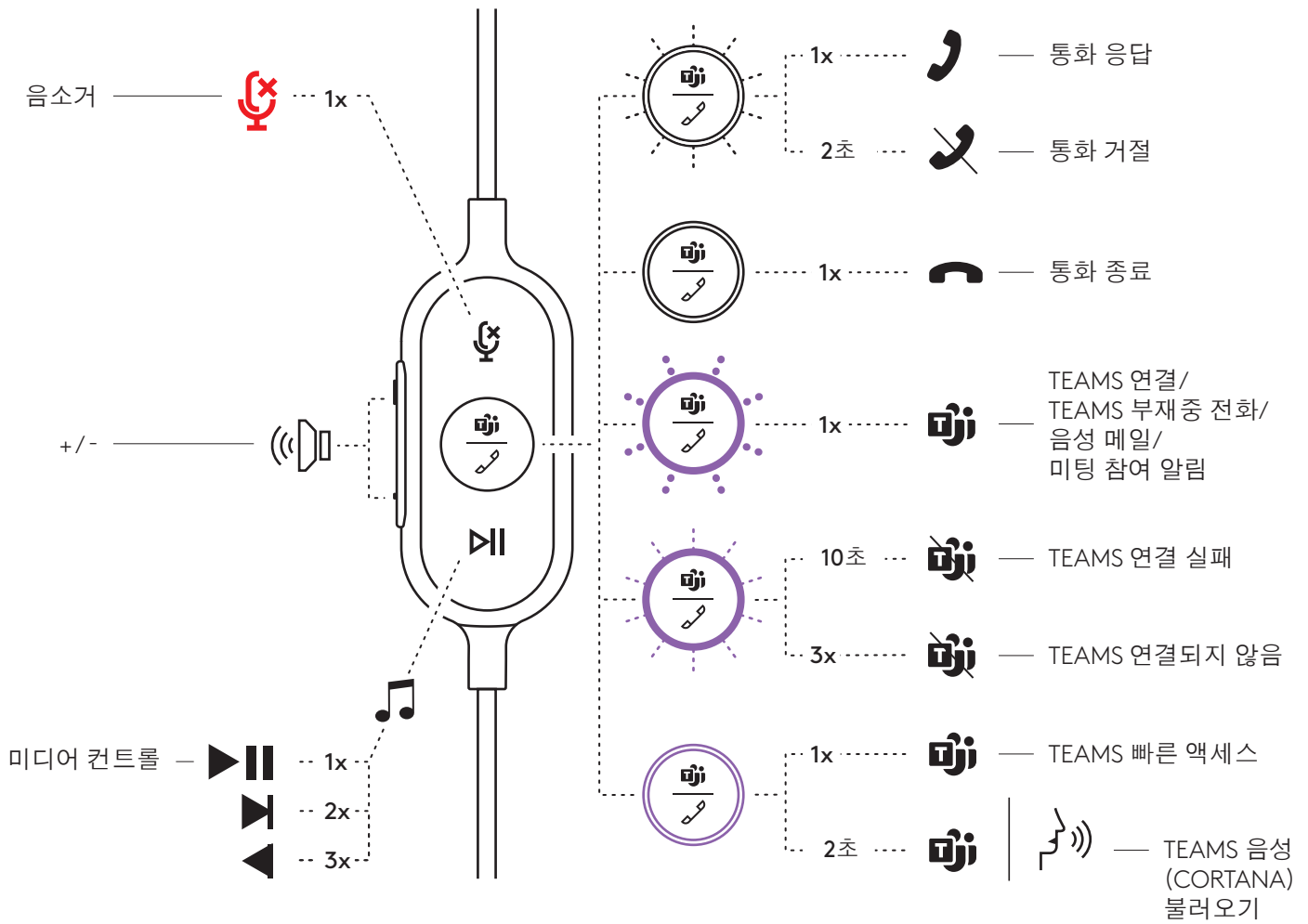

UC 버전				
단추	용도	표시등	동작	
🔇	음소거	음소거 켜짐	빨간색으로 유지	짧게 눌러 음소거/음소거 해제
		음소거 꺼짐	불빛 없음	
☎	통화 제어	걸려온 통화	하얀색으로 깜박임	짧게 눌러 통화 응답
		진행 중인 통화	흰색으로 유지	2초간 눌러 통화 거부
	음성 지원	불빛 없음	짧게 눌러 통화 종료	2초 동안 눌러 음성 도우미 불러오기*
▶⏸	미디어 컨트롤	불빛 없음	짧게 눌러 재생/일시 정지	
+			두 번 눌러 트랙 앞으로	
-			세 번 눌러 트랙 뒤로	
+	볼륨	불빛 없음	짧게 눌러 볼륨 높이기	
-			짧게 눌러 볼륨 줄이기	

\*음성 도우미 기능은 장치 모델에 따라 달라집니다.

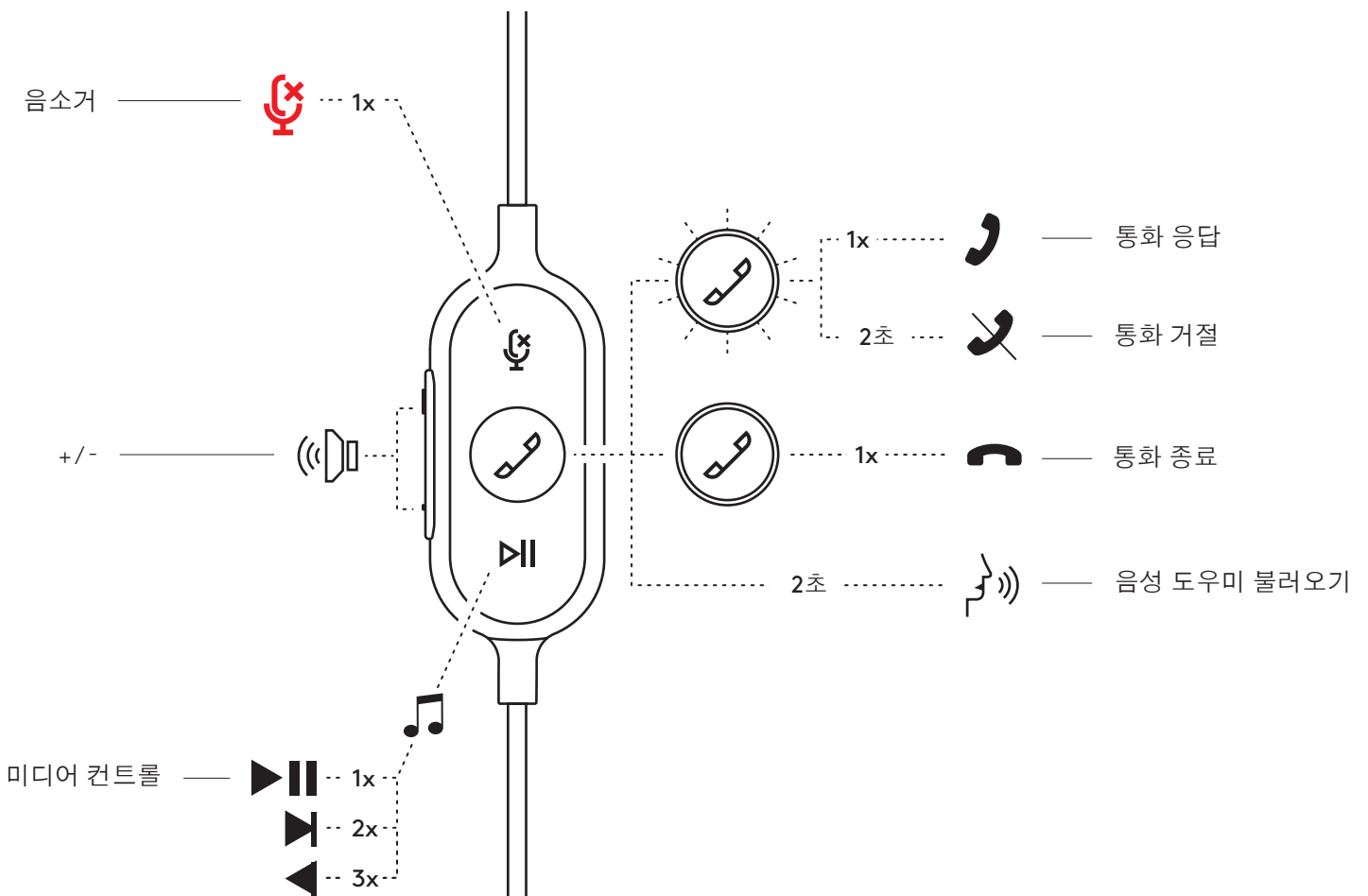

## LOGI TUNE 데스크탑(PC 파트너 앱)

Logi Tune 데스크탑은 주기적인 소프트웨어 및 펌웨어 업데이트로 헤드셋 성능 향상에 도움이 되며 5밴드 EQ 커스텀으로 들리는 소리를 조절할 수 있습니다. 마이크 게인, 촉음 컨트롤 등으로 본인의 음성을 제어하는 것을 도와줍니다. 편리한 미니맵으로 화상 회의 중에도 오디오를 조절할 수 있습니다.

다음 페이지에서 Logi Tune 데스크탑에 대해 더 알아보고 다운로드하세요.

[www.logitech.com/LogiTune](http://www.logitech.com/LogiTune)

## LOGI TUNE 헤드셋 사운드 탐색하기

1. 마이크 게인을 조절하여 통화 중 내 음성의 크기를 변경합니다.
2. 통화 중 본인의 목소리를 더욱 잘 들을 수 있도록 촉음을 조절합니다.
3. 다양한 음악 유형에 맞춘 프리셋으로 이퀄라이저를 조절하거나 커스텀 EQ 설정을 생성합니다.
4. 스피커, 마이크, 인터넷 연결을 이용하여 헤드셋을 테스트합니다. 테스트 요약은 드라이버 및 OS 관련 문제에 대한 시스템 수정 도구에 도움이 됩니다.
5. 소프트웨어 업데이트 알림. 수락하려면 탭 하세요.

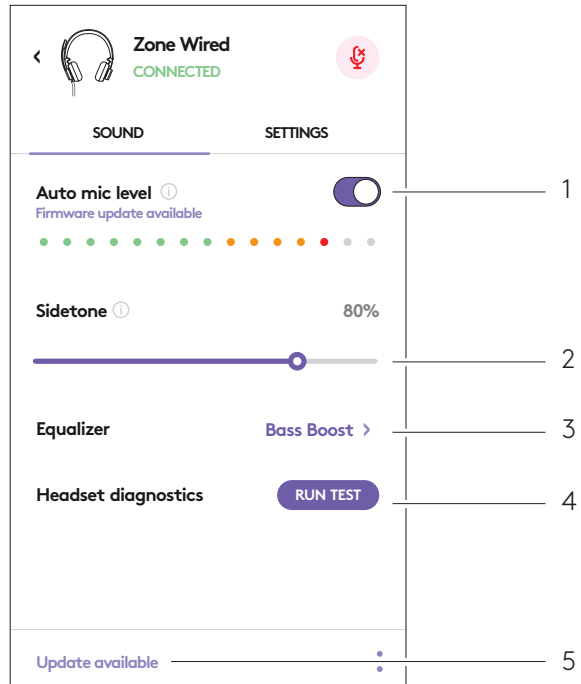

## LOGI TUNE 헤드셋 설정 탐색하기

1. 헤드셋 정보 > 는 장치 세부 사항 및 펌웨어 정보를 요약하여 알려줍니다.
2. 음성 안내를 컨트롤합니다.
3. 플립 음소거를 컨트롤합니다.
4. 자동 앱 업데이트 - 백그라운드에서 업데이트를 활성화하면 앱이 항상 최신 상태로 유지됩니다.
5. 앱 알림 컨트롤.

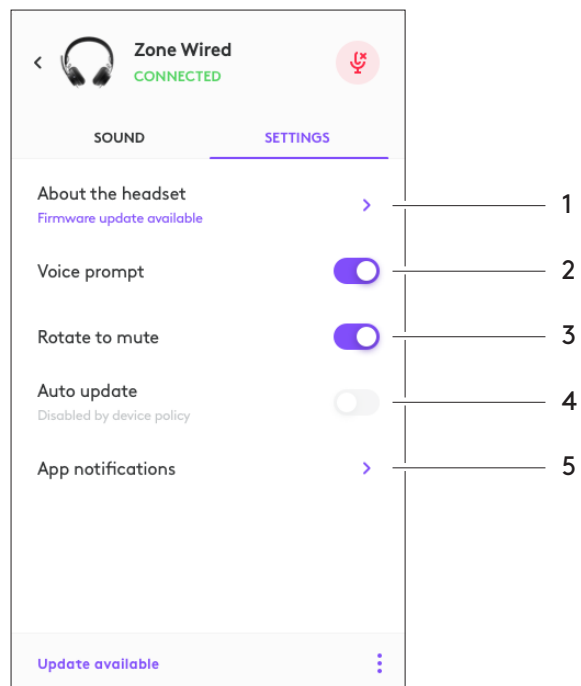

다음 페이지에서 엔터프라이즈용 Tune 대량 배포 및 구성에 대해 자세히 알아보십시오.

[www.logitech.com/logitune](http://www.logitech.com/logitune)



## 사이즈

헤드셋:

높이 x 너비 x 깊이: 165.93mm x 179.73mm x 66.77mm

무게: 0.211 Kg

이어 패드 치수:

높이 x 너비 x 깊이: 65.84mm x 65.84mm x 18.75mm

어댑터:

높이 x 너비 x 깊이: 21.5mm x 15.4mm x 7.9mm

## 시스템 요구 사항

USB-C 또는 USB-A 포트가 달린 Windows 또는 Mac 기반 컴퓨터.

## 기술 사양

입력 임피던스: 32 Ohms

감도 (헤드폰): 1000Hz @30mW에서 99dB±3dB, 1cm

감도 (마이크): 기본 마이크: -48 dBV/Pa, 보조 마이크: -40 dBV/Pa

주파수 응답 (헤드셋): 20~16 kHz

주파수 응답 (마이크): 100~16 kHz

케이블 길이: 1.9 m