

# C920 PRO HD WEBCAM

Complete Setup Guide  
设置指南

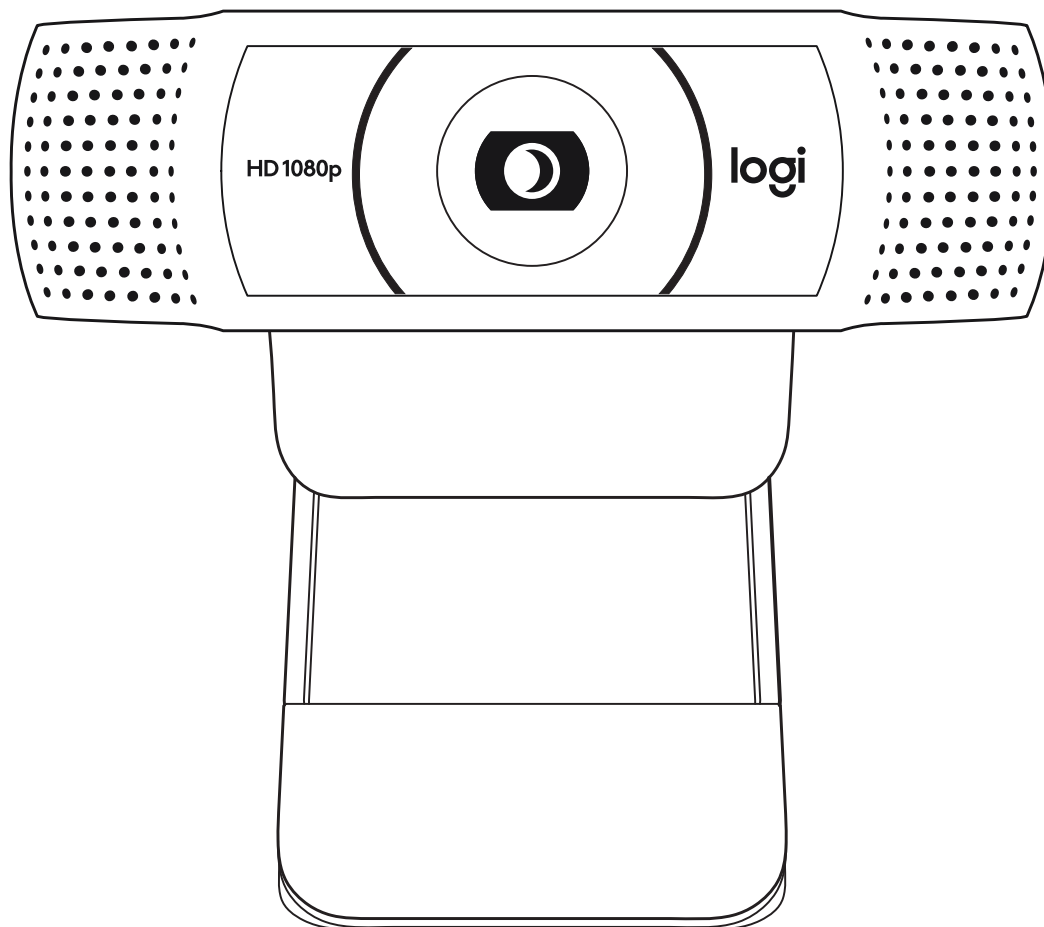

logitech®

# CONTENTS

English . . . . .3

简体中文 . . . . .7

繁體中文 . . . . . 11

한국어 . . . . . 15

Indonesia . . . . . 19

# KNOW YOUR PRODUCT

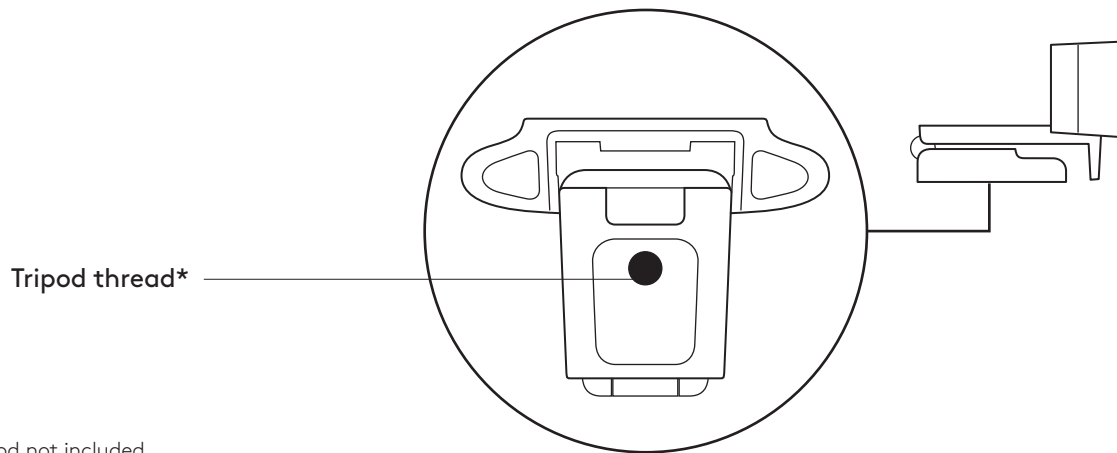
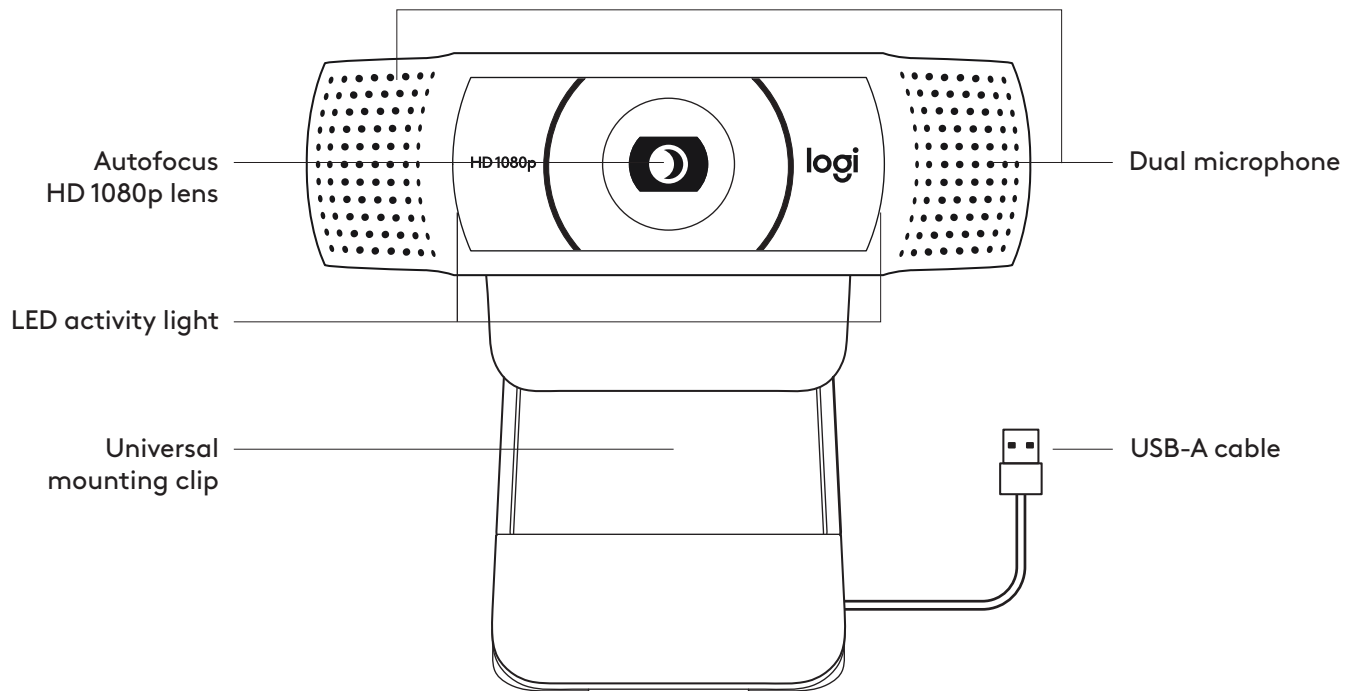

\* Tripod not included

## WHAT'S IN THE BOX

- 1 Webcam with 5 ft (1.5 m) attached USB-A cable
- 2 User documentation

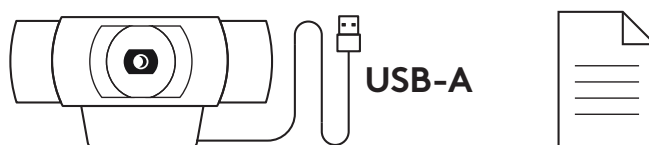

## SETTING UP THE WEBCAM

For placement on a monitor

- 1 Place your webcam on a computer, laptop or monitor at a position or angle you desire.

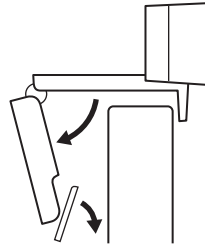

- 2 Adjust the webcam to make sure the foot on the universal mounting clip is flush with the back of your device.

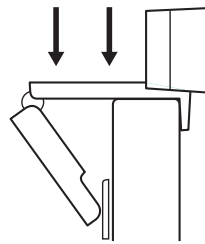

- 3 Manually adjust the webcam up/down to the best position to frame yourself.

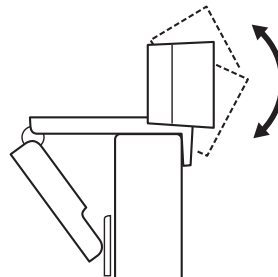

For placement on a tripod\*

- 1 Locate the ¼ inch tripod thread on the bottom of the universal mounting clip.

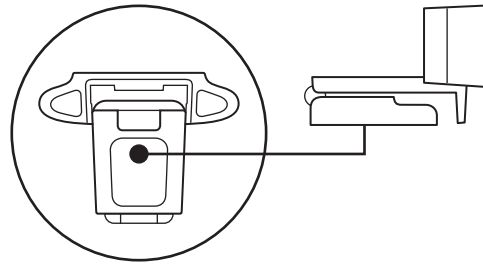

- 2 Secure the webcam on your tripod by twisting it into the ¼ inch thread.

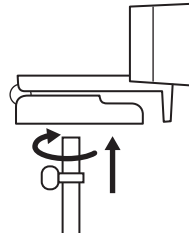

- 3 Place your webcam with the tripod anywhere you desire to the best position to frame yourself.

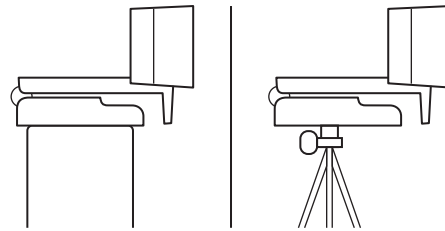

\* Tripod not included

### CONNECTING THE WEBCAM VIA USB-A

Plug the USB-A connector into the USB-A port on your computer.

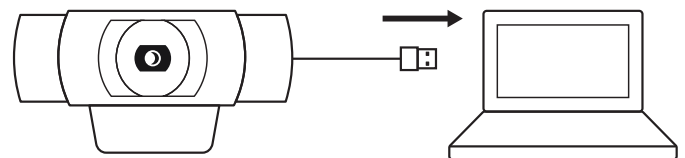

## SUCCESSFUL CONNECTION

LED activity light will light up when the webcam is in use by an application.

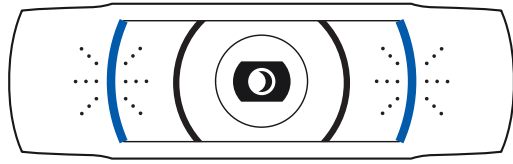

## DIMENSIONS

### INCLUDING FIXED MOUNTING CLIP:

Height x Width x Depth:  
1.70 in (43.3 mm) x 3.70 in (94 mm) x 2.80 in (71 mm)

Cable Length: 5 ft (1.5 m)

Weight: 5.71 oz (162 g)

[www.logitech.com/support/C920](http://www.logitech.com/support/C920)

# 了解您的产品

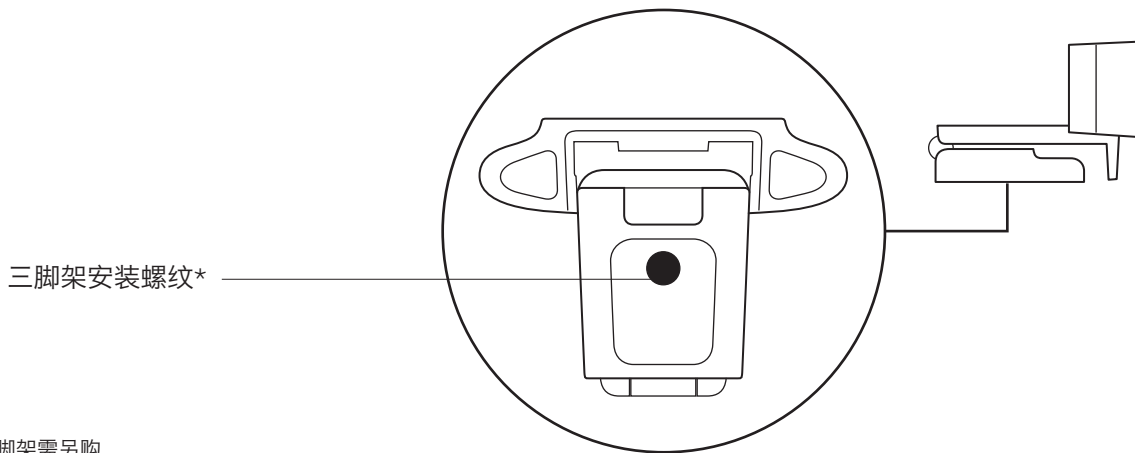
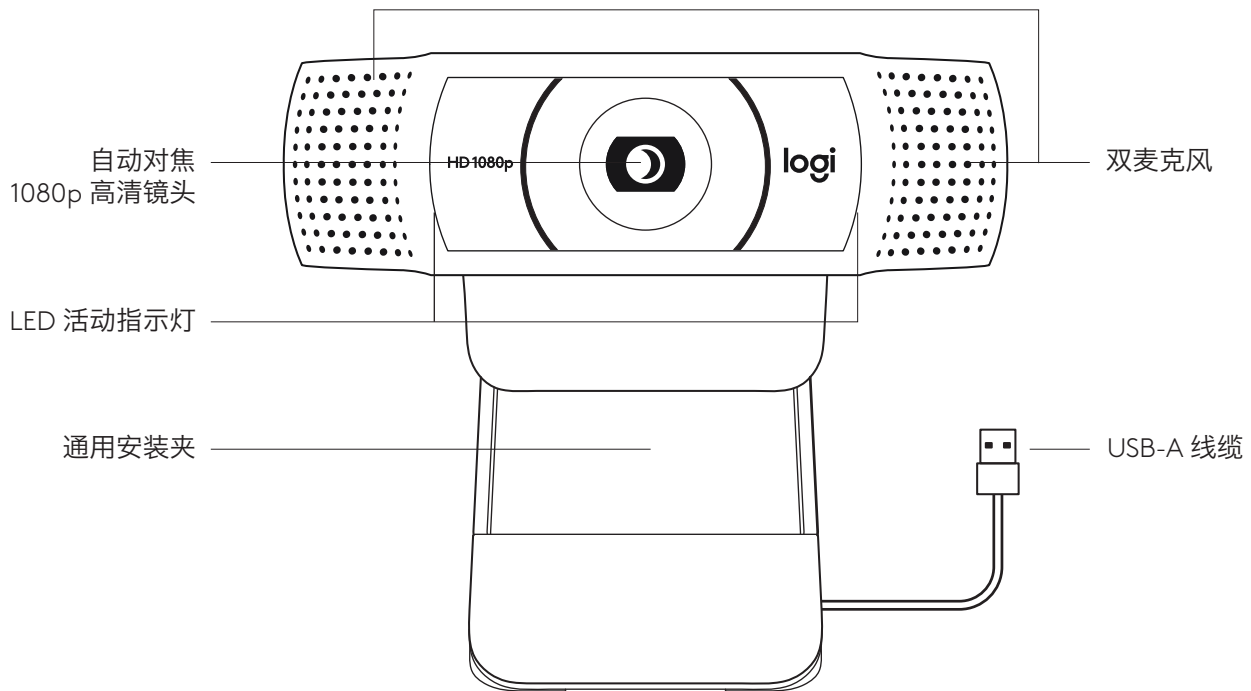

\*三脚架需另购

## 包装内容

- 1 网络摄像头, 附约 1.5 米 USB-A 线缆
- 2 用户文档

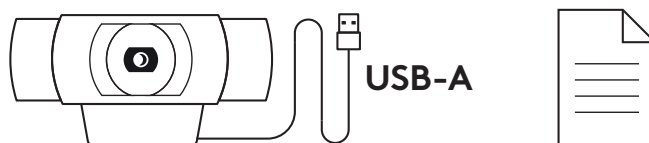

## 设置网络摄像头

放置于显示器上

- 1 将网络摄像头以所需的位置或角度放置在电脑、笔记本电脑或显示器上。

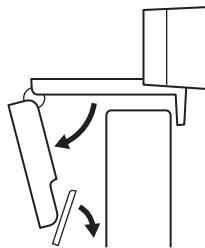

- 2 调节网络摄像头，确保通用安装夹支脚与显示器背面齐平。

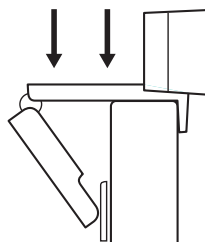

- 3 手动将网络摄像头上/下调节至合适的构图位置。

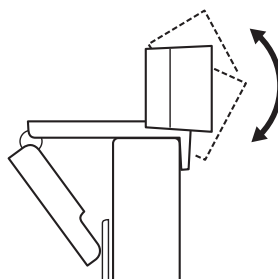



放置于三脚架上\*

1 找到通用安装夹底部的 ¼ 英寸三脚架安装螺纹。

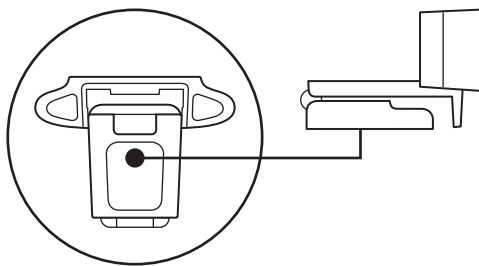

2 将三脚架拧入 ¼ 英寸安装螺纹，将网络摄像头固定于三脚架上。

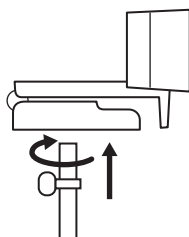

3 将网络摄像头和三脚架放置于您想要的合适位置以构图。

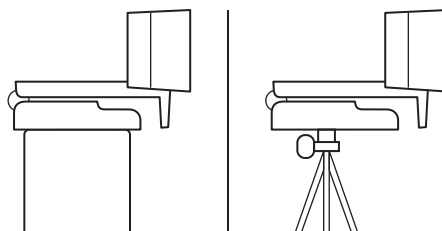

\*三脚架需另购

**通过 USB-A 连接网络摄像头**

将 USB-A 接头插入电脑的 USB-A 端口。

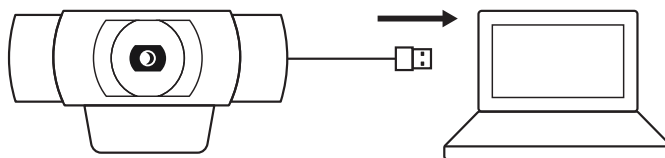

## 成功连接

当应用程序使用网络摄像头时，LED 活动指示灯将点亮。

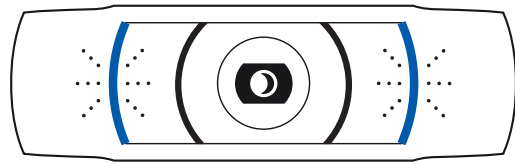

## 规格

### 包括固定的安装夹:

高 x 宽 x 深:

约 43.3 毫米 x 约 94 毫米 x 约 71 毫米

线缆长度: 约 1.5 米

重量: 约 162 克

[www.logitech.com/support/C920](http://www.logitech.com/support/C920)

## 瞭解您的產品

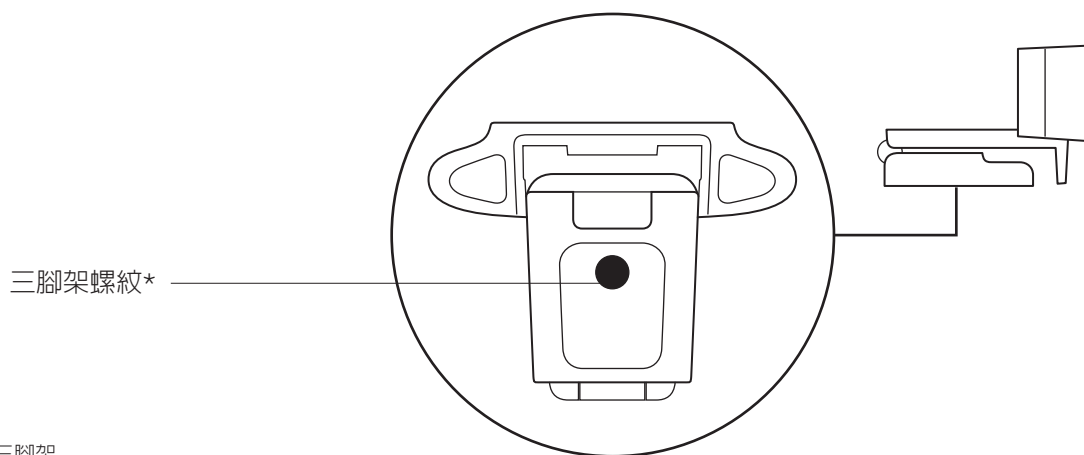
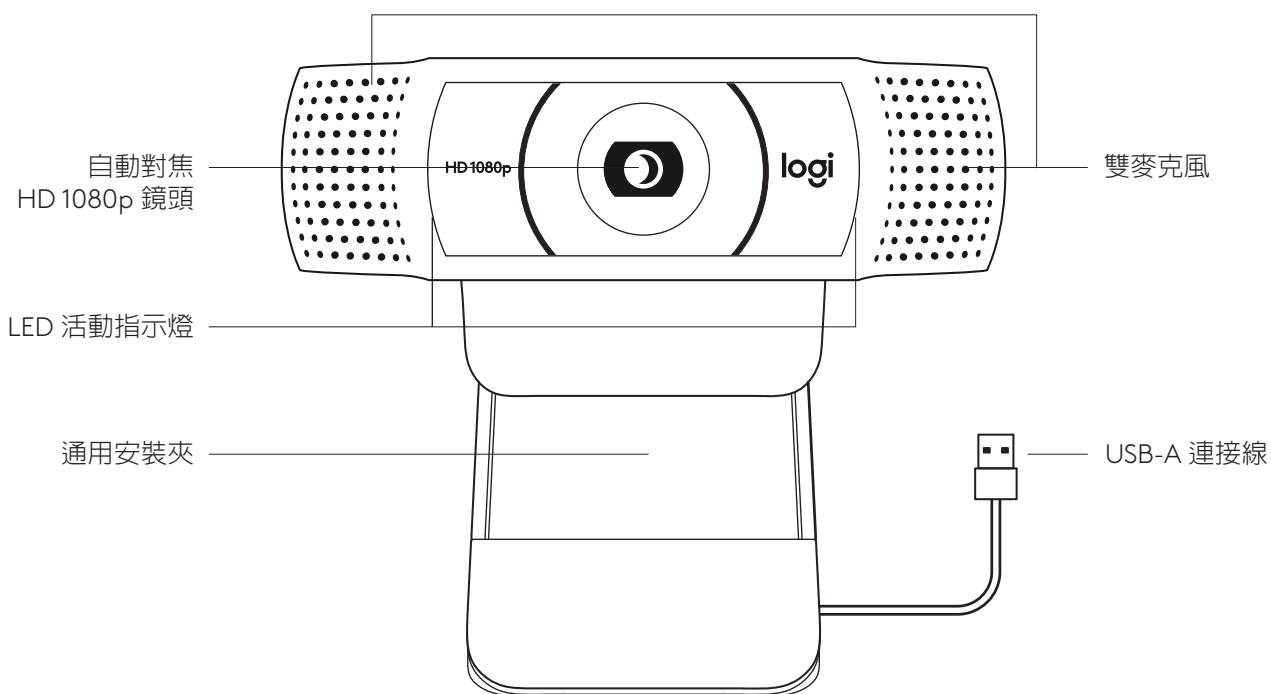

\* 未隨附三腳架

### 包裝內容

- 1 含 1.5 公尺 (5 英尺) USB-A 連接線的網路攝影機
- 2 使用者文件



## 設定網路攝影機

放在螢幕上

- 1 將網路攝影機放到電腦、筆記型電腦或顯示器上您要的位置或角度。

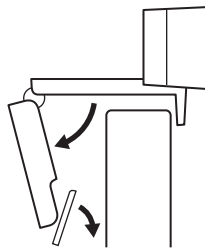

- 2 調整網路攝影機，確認通用安裝夾的腳架與您的裝置背面齊平。

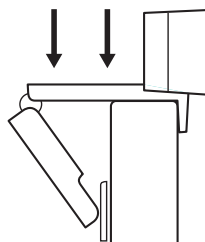

- 3 手動上/下調整網路攝影機，將其調整到對準您取景的最佳位置。

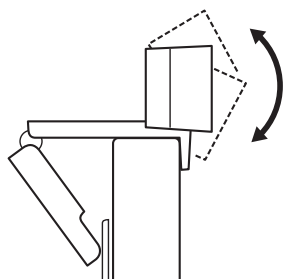

放在三腳架上\*

- 1 找到位於通用安裝夾具底部上的 ¼ 英吋三腳架安裝螺紋。

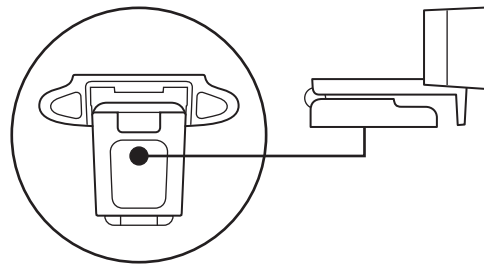

- 2 將三腳架轉入 ¼ 英吋螺紋中，使網路攝影機固定在三腳架上。

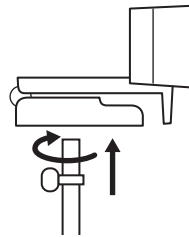

- 3 將網路攝影機連同三腳架放在您想要的、能夠獲得最佳自拍角度的任何位置。

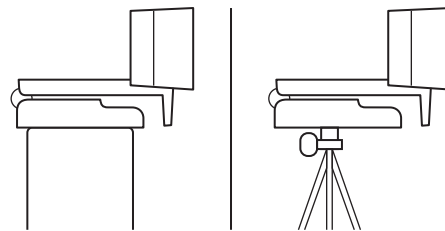

\* 未隨附三腳架

### 透過 USB-A 連接網路攝影機

將 USB-A 接頭插入您電腦的 USB-A 連接埠。

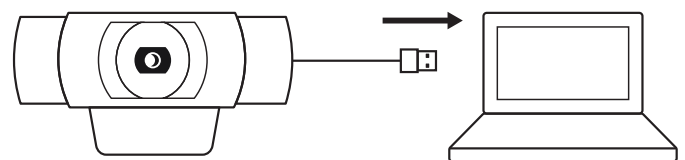

## 成功連接

LED 活動指示燈會在應用程式使用網路攝影機時亮起。

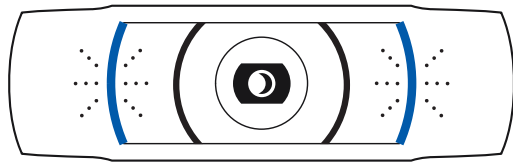

## 尺寸

包含固定安裝夾：

高 x 寬 x 深：

43.3 公釐 (1.70 英吋) x 94 公釐 (3.70 英吋) x 71 公釐 (2.80 英吋)

連接線長度：1.5 公尺 (5 英呎)

重量：162 公克 (5.71 盎司)

[www.logitech.com/support/C920](http://www.logitech.com/support/C920)

# 제품 설명

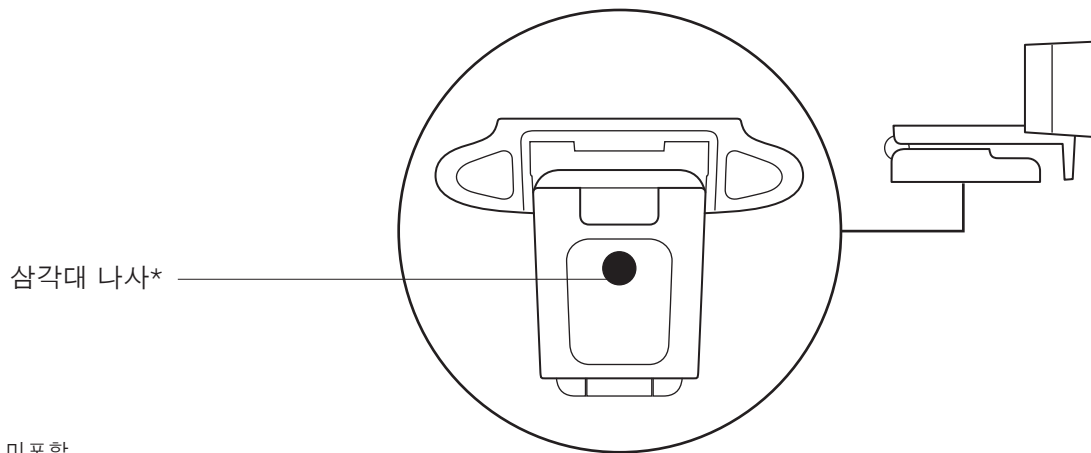
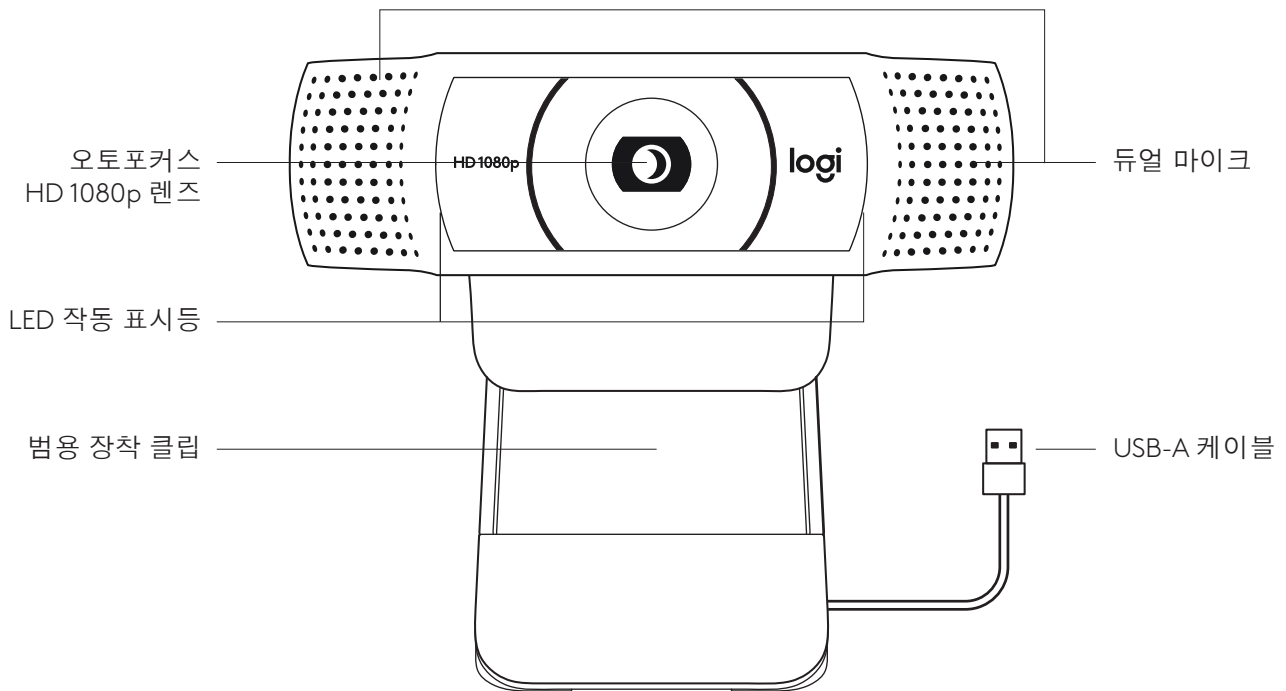

\* 삼각대 미포함

## 박스 내용물

- 1 1.5m(5피트) USB-A 케이블이 부착된 웹캠
- 2 사용 설명서

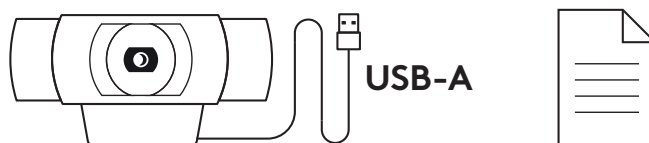

## 웹캠 설정

모니터에 배치할 경우

- 1 컴퓨터 위, 노트북, 모니터 등 원하는 위치 및 각도에 웹캠을 거치합니다.

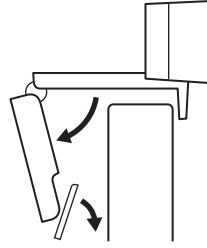

- 2 웹캠을 조절하여 거치할 장치의 후면과 범용 장착 클립의 발이 평행을 이루게 합니다.

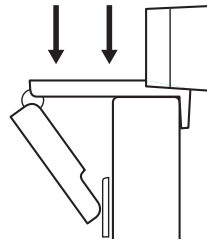

- 3 웹캠을 위아래로 조절하여 최적의 촬영 위치를 찾습니다.

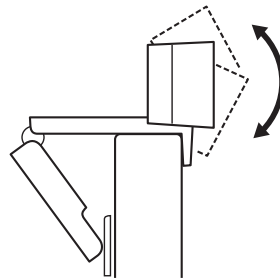



삼각대에 배치할 경우\*

1 범용 장착 클립 하단에서 ¼인치 삼각대 나사를 찾습니다.

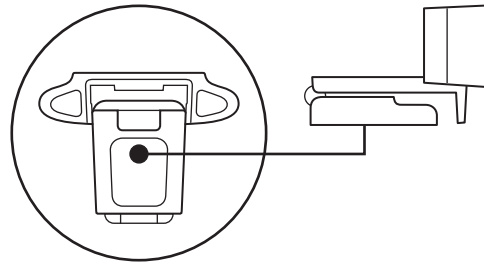

2 웹캠을 ¼인치 나사에 끼워 삼각대에 고정합니다.

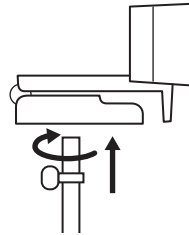

3 삼각대에 장착된 웹캠을 배치하여 최적의 촬영 위치를 찾습니다.

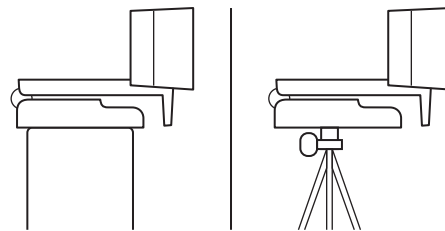

\* 삼각대 미포함

### USB-A로 웹캠 연결

USB-A 커넥터를 컴퓨터 USB-A 포트에 연결합니다.

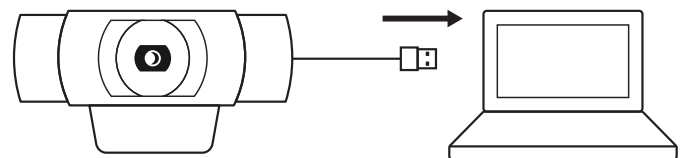

## 연결 성공

애플리케이션에서 웹캠을 사용하면 LED 작동 표시등에 불이 들어옵니다.

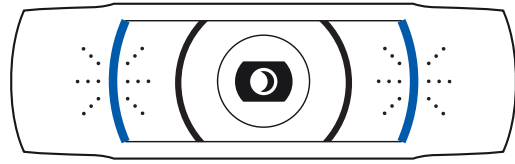

## 규격

### 고정 장착 클립 포함

높이 x 너비 x 깊이:

43.3mm(1.70인치) x 94mm(3.70인치) x 71mm(2.80인치)

케이블 길이: 1.5미터 (5피트)

무게: 162g(5.71oz)

[www.logitech.com/support/C920](http://www.logitech.com/support/C920)

## MENGENAL PRODUK

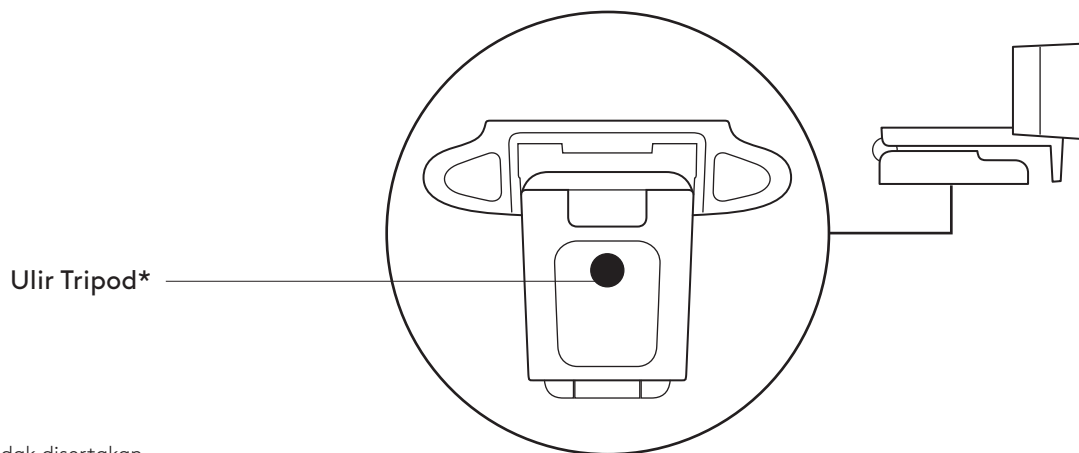
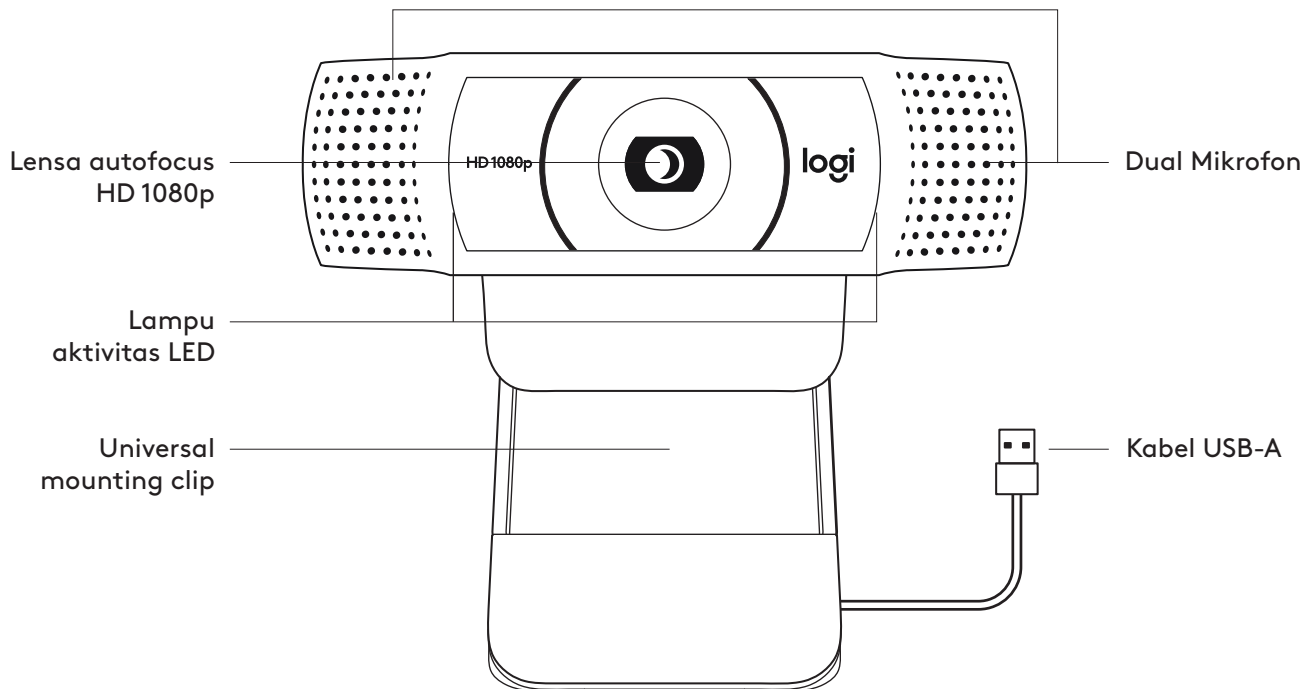

\* Tripod tidak disertakan

### ISI KEMASAN

- 1 Webcam dengan kabel USB-A 5 kaki (1,5 m) terpasang
- 2 Dokumentasi pengguna



## MEMASANG WEBCAM

Untuk penempatan di atas layar

- 1 Letakkan webcam Anda di komputer, laptop, atau layar pada posisi atau sudut yang Anda inginkan.

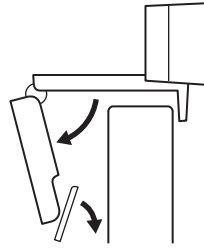

- 2 Sesuaikan webcam untuk memastikan kaki universal mounting clip terpasang erat dengan bagian belakang perangkat Anda.

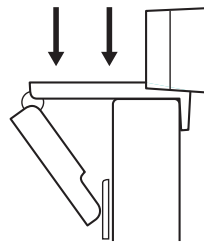

- 3 Gerakkan webcam ke atas/ke bawah ke posisi terbaik agar bisa menangkap diri Anda.

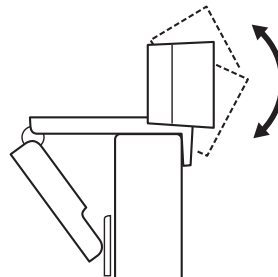

Untuk penempatan di atas tripod\*

- 1 Cari ulir tripod ¼ inci di bagian bawah universal mounting clip.

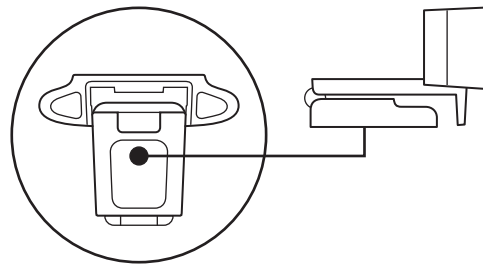

- 2 Pasangkan webcam di tripod Anda dengan memutarinya pada ulir ¼ inci.

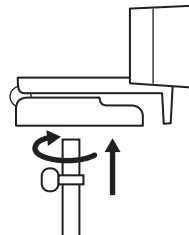

- 3 Letakkan webcam yang telah terpasang di tripod di mana pun yang Anda inginkan agar mendapatkan posisi terbaik untuk menyorot diri Anda.

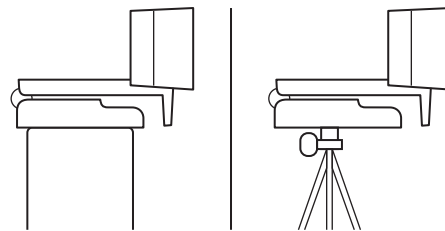

\* Tripod tidak disertakan

### MENGHUBUNGKAN WEBCAM VIA USB-A

Pasangkan konektor USB-A ke port USB-A di komputer Anda.

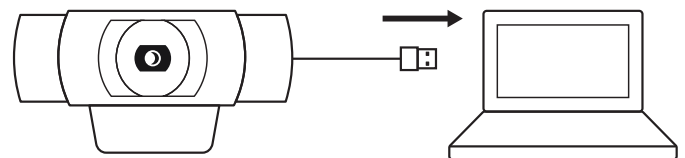

## KONEKSI BERHASIL

Lampu aktivitas LED akan menyala ketika webcam digunakan oleh sebuah aplikasi.

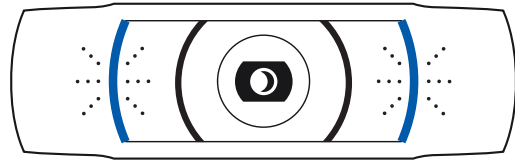

## DIMENSI

### TERMASUK FIXED MOUNTING CLIP:

Tinggi x Lebar x Tebal:

1,70 inci (43,3 mm) x 3,70 inci (94 mm) x 2,80 inci (71 mm)

Panjang Kabel: 5 kaki (1,5 inci)

Berat: 5,71 oz (162 g)

[www.logitech.com/support/C920](http://www.logitech.com/support/C920)