

# Operation Manual

**Pure Sine Wave Inverter**  
**300/600/1000/1600/2500/3500W**

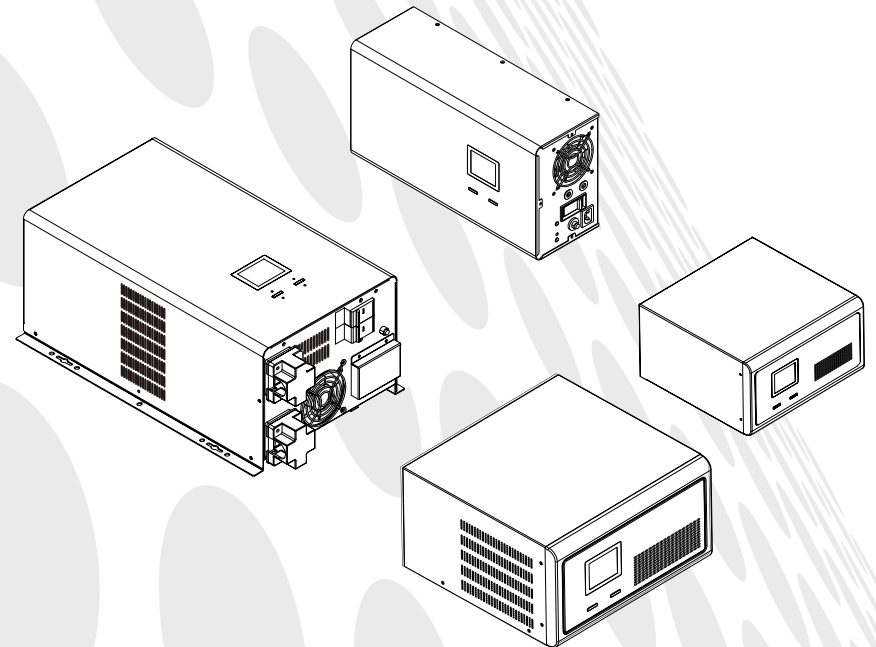

# Table of Contents

<b>1 Safety Information</b> .....	<b>1</b>
<b>2 Product Overview</b> .....	<b>2</b>
2.1 Specifications.....	2
2.2 Front panel features.....	4
2.3 Rear panel features.....	5
<b>3 Installation Instructions</b> .....	<b>6</b>
3.1 Unpacking inspection.....	6
3.2 Installation.....	6
<b>4 Operations</b> .....	<b>8</b>
4.1 Turn the inverter On / Off.....	8
4.2 Display interface.....	8
4.3 MPPT & DC modules (Optional) status indicators.....	9
4.4 Settings.....	9
<b>5 Troubleshooting</b> .....	<b>12</b>

# 1 Safety Information



## CAUTION

Non-qualified electricians are forbidden to open the case due to hazard of electrical shock.

Consulting the dealer is required before using for below equipment. Its application, configuration, management and maintenance must be specially considered and designed.

- Medical equipment which is directly related to patients'life
- Elevator and other equipment which may endanger personal safety



## Safety and General Information

- Read all safety information and operating instructions carefully before attempting to install, operate, service or maintain the inverter.
- Do not disassemble this inverter. Contact your local service center if maintenance or repair is needed.
- Disconnect all connection wiring before maintenance or cleaning to avoid the risk of electric shock.
- Do not use liquid extinguisher if there is a fire, a dry powder extinguisher is recommended.
- Do not dispose of the batteries with fire. The batteries may explode.
- Do not open or mutilate batteries. Released electrolyte inside is harmful to the skin and eyes, and maybe toxic.
- Do not connect the positive pole and negative pole directly, otherwise it will cause electric shocks or will be on fire.

## 2 Product Overview

### 2.1 Specifications

MODEL	300 W	600 W	1000 W	1600 W	2500 W	3500 W
<b>DC Input</b> (the inverter must be connected to batteries to work properly)						
Nominal input voltage	12 V			24 V		
DC input range	10 ~ 15 V			20 ~ 30 V		
<b>AC Input</b>						
Bypass input range	0 ~ 264 Vac for 220 Vac / 230 Vac / 240 Vac, 0 ~ 132 Vac for 100 Vac / 110 Vac / 115 Vac / 120 Vac					
Mains input range	150 ~ 282 Vac for 220 Vac; 163 ~ 307 Vac for 240 Vac; 75 ~ 141 Vac for 110 Vac; 82 ~ 154 Vac for 120 Vac.		156 ~ 294 Vac for 230 Vac; 68 ~ 128 Vac for 100 Vac; 79 ~ 148 Vac for 115 Vac;			
Input frequency range	50 Hz / 60 Hz (Auto-sense & Settable: 5% ~ 15%, default 15%), 42.5 ~ 57.5 Hz for 50 Hz, 51 ~ 69 Hz for 60 Hz					
Input range of the generator	99 ~ 282 Vac for 220 Vac; 108 ~ 307 Vac for 240 Vac; 50 ~ 141 Vac for 110 Vac; 54 ~ 154 Vac for 120 Vac.		104 ~ 294 Vac for 230 Vac; 45 ~ 128 Vac for 100 Vac; 52 ~ 148 Vac for 115 Vac; No AVR in generator mode			
Input frequency range of the generator	40 ~ 70 Hz					
Input power matching of the generator	Rated power 10% ~ 150%, regulating step 10%, default 120%					
<b>Output</b>						
Inverter output range	220 Vac / 230 Vac / 240 Vac $\pm$ 5% or 100 Vac / 110 Vac / 115 Vac / 120 Vac $\pm$ 5% (settable)					
Bypass output range	0 ~ 264 Vac for 220 V / 230 V / 240 V, 0 ~ 132 Vac for 100 V / 110 V / 115 V / 120 V					
Mains output range	174 ~ 242 Vac for 220 Vac; 190 ~ 264 Vac for 240 Vac; 87 ~ 121 Vac for 110 Vac; 95 ~ 133 Vac for 120 Vac.		182 ~ 253 Vac for 230 Vac; 79 ~ 109 Vac for 100 Vac; 93 ~ 125 Vac for 115 Vac;			
Output frequency	50 Hz / 60 Hz $\pm$ 0.3 (Auto-sense & settable)					
Output waveform	Pure sine wave					
Output power	300 W	600 W	1000 W	1600 W	2500 W	3500 W
Efficiency	Max. 95% (Mains mode); Max. 80% (Inverter mode)					
ECO mode	Settable, load < 3%, enter in 80 s					
No-load shutdown	Settable, time can be set (1 ~ 99 min), load can be set (3% ~ 50%)					
Transfer time	10 ms				15 ms	
Power factor	1.0					
THDV	< 5% (linear load)					
Inductive load	Yes					
Motor load	Yes					
Rectifier load	Yes					
Overload capability	Mains mode: 110% 120 s; 125% 60 s; 150% 10 s (switch to bypass) Inverter mode: 110% 60 s; 125% 10 s; 150% 10 s (shut down)					

<b>Battery</b>						
Charging current (selectable)	Default 10 A	Default 20 A, regulating step 1 A (< 10 A) / 5 A (> 10 A)				
	Max. 15 A	Max. 30 A	Max. 40 A	Max. 40 A	Max. 50 A	Max. 60 A
Equalizing charge voltage	Single battery 14.4 Vdc (default), 13.6 ~ 15 Vdc settable					
Floating charge voltage	Single battery 13.7 Vdc (default), 13.2 ~ 14.6 Vdc settable					
DOD	Single battery 10.8 Vdc (default), 9.6 ~ 13 Vdc settable					
EOD	Single battery 10.2 Vdc (default), 9.6 ~ 11.5 Vdc settable					
Reverse warning	Buzzer					
<b>Alarm</b>						
Switch on / off	Continuous beep 2 s					
Low battery	Beep 0.2 s at interval of 0.4 s					
Overload	Beep 2 s at interval of 2.5 s					
Mains power abnormal	Beep 0.3 s at interval of 5 s					
<b>MPPT Modules (Optional)</b>						
Model	10 A / 20 A / 30 A / 40 A			/	/	
Max. PV input voltage (Voc)	40 V			60 V	/	/
PV optimum operating voltage (Vmp)	18 V ~ 32 V			29 V ~ 48 V	/	/
Max.PV power	120 W / 240 W / 360 W / 480 W			240 W / 480 W / 720 W / 960 W	/	/
<b>DC Modules (Optional)</b>						
Model	5 V (2 A), 9 V / 12 V (1 A), 15 V / 24 V (1 A), 12 V / 24 V (10 A)					
<b>Others</b>						
Protections	Overload – short-circuit – overvoltage – undervoltage – overcharge – overtemperature – excessive low battery – missing insert					
Interface	LCD & BUZZER					
Operating temperature	0°C ~ 40°C					
Operating humidity	Relative humidity 93%					
Altitude	< 1000 m, (above 1000 m, derating 1% for each additional 100 m), 4000 m max.					
Net weight (kg)	8.0/8.5/7.4	10.9/11.4/11	14.0/14.6	18.0/18.5	32.0	36.0
Gross weight (kg)	9.0/9.5/8.4	11.9/12.4/12	15.0/15.6	19.0/19.5	34.0	38.0
Dimensions (WxDxH) mm	280x258x120 (w/o option) 293x280x160 (w/ option) 400x210x127 (Wall mounted)		293x280x160		302x479x209	
Packaged dimensions (WxDxH) mm	330x352x200 (w/o option) 370x355x235 (w/ option) 490x290x195 (Wall mounted)		370x355x235		353x582x287	

Note: Specifications are subject to change without notice.

## Charging features

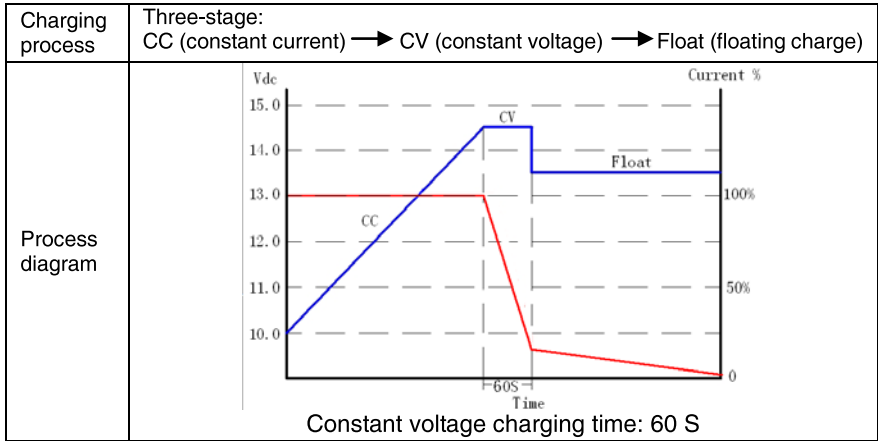

## 2.2 Front panel features

### 300 W ~ 1600 W front panel

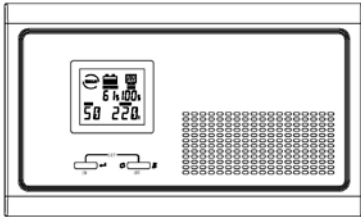

Tower type

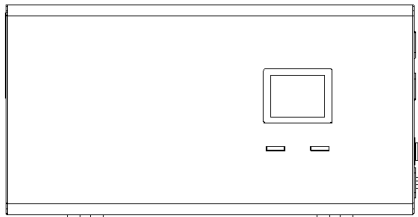

Wall mounted type

### 2500 W ~ 3500 W front panel



## 2.3 Rear panel features

### 300 W ~ 1600 W rear panel

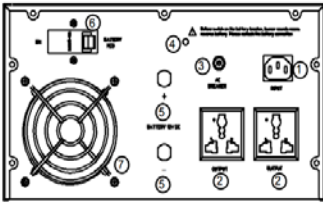

Tower type

- ① AC input socket
- ② Output sockets
- ③ Overcurrent protector
- ④ Buzzer for battery reverse
- ⑤ Battery wiring
- ⑥ Battery breaker
- ⑦ Fan

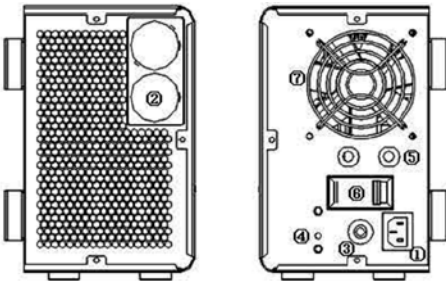

Wall mounted type

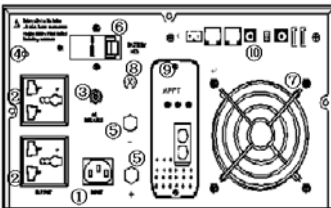

Optional model (with MPPT / DC modules)

- ⑧ DC output fuse
- ⑨ MPPT (optional)
- ⑩ DC output (optional)

### 2500 W ~ 3500 W rear panel

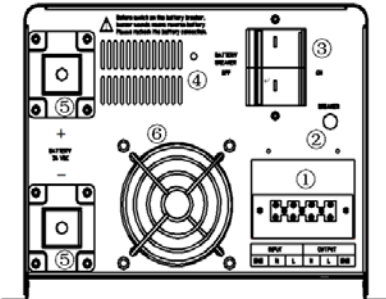





- ① Input/output terminal block
- ② Overcurrent protector
- ③ Battery breaker
- ④ Buzzer for battery reverse
- ⑤ Battery wiring terminal
- ⑥ Fan

# 3 Installation Instructions

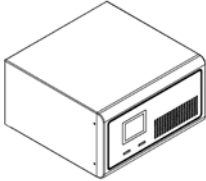
## 3.1 Unpacking inspection

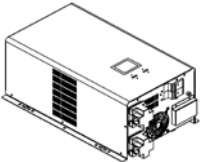
Inspect the contents upon receipt. Notify the carrier and dealer if the unit is damaged.

300 W ~ 1600 W package contents		
 <p>300 W ~ 1600 W Inverter</p>	 <p>AC input power cords</p>	 <p>Operation manual</p>
2500 W ~ 3500 W package contents		
 <p>2500 W ~ 3500 W Inverter</p>	 <p>Operation manual</p>	

## 3.2 Installation

 <b>CAUTION</b>
<p>The inverter is designed for indoor use. Do not operate this UPS in direct sunlight, in contact with fluids, or where there is excessive dust or humidity.</p>
<p>Place batteries in sound ventilation environment.</p>
<p>Use insulated tools to reduce the risk of short-circuit when installing or working with the inverter, the batteries, or other equipments attached to this unit.</p>
<p>Be sure that the ground terminal has been connected with the ground.</p>

### 3.2.1 Installation information

- Inspect whether the battery voltage and Mains voltage are correct or not.
- Connect the inverter with batteries, utility power and loads. Be sure all wiring is correct, terminals are screwed tightly and terminal cover is locked.
- Open the battery breaker, press ON button, then the inverter starts up in 3 seconds, and then check if the load has problem (overload, short-circuit ect.). If it does, check and correct until confirming it is normal, and then connect to the utility power.



### 3.2.2 Connect external battery

#### 300 W / 600 W / 1000 W inverter battery connection

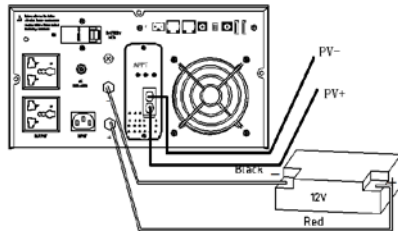
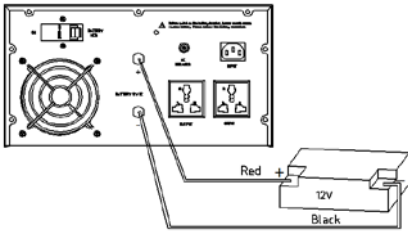

Optional model (with MPPT modules)

(Note that the red cable is connected to the positive terminal, black cable is connected to the negative terminal)

#### 1600 W inverter battery connection

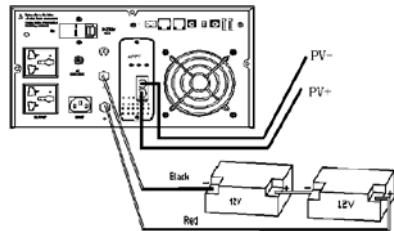
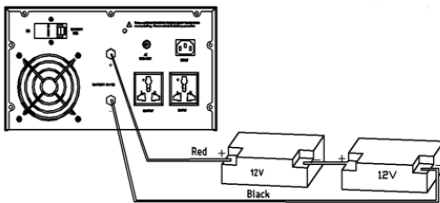

Optional model (with MPPT modules)

(Note that the red cable is connected to the positive terminal, black cable is connected to the negative terminal)

#### 2500 W / 3500 W inverter battery connection

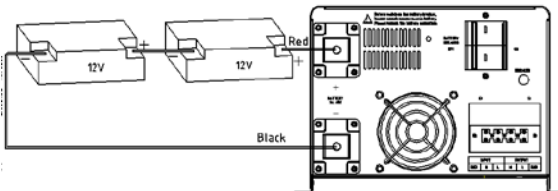

(Note that the red cable is connected to the positive terminal, black cable is connected to the negative terminal, and 2500 W battery cable is more than 35 mm<sup>2</sup>, 3500 W battery cable is more than 50 mm<sup>2</sup>)

# 4 Operations



Turn on the inverter in battery mode first. Be sure that the load has no problem (overload, short-circuit ect.) before connecting to utility power.

## 4.1 Turn the inverter On / Off

- Without connecting to utility power, press and hold “ON” button for 3 seconds, release it until the buzzer beeps, the inverter starts up. In the process of the inverter running, press and hold “OFF” button for 3 seconds, release it until the buzzer beeps, the inverter is shut down.
- When the inverter works in mains power / AC mode, press and hold “OFF” button for 3 seconds, release it until the buzzer beeps, the inverter goes to bypass mode.
- When the inverter works in bypass mode, press and hold “ON” button for 3 seconds, release it until the buzzer beeps, the inverter goes to AC mode.

## 4.2 Display interface

### Inverter mode

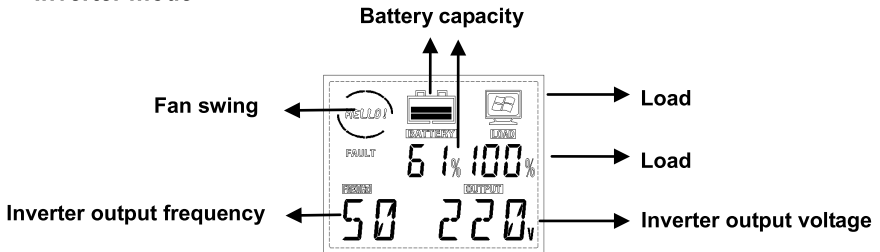

### Mains power mode

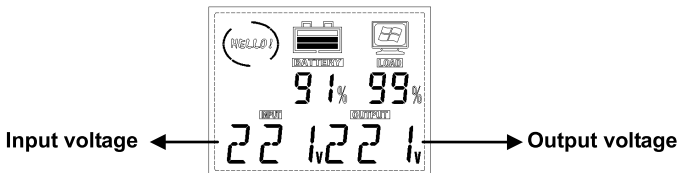

### 4.3 MPPT & DC modules (Optional) status indicators

Modules	Status	LED Indicators	Action
MPPT Module	Normal PV charging	Yellow and green indicators are lit continuously	Operating is normal
	MPPT over-temperature	Red indicator is lit continuously	MPPT charging is turned off
	PV low voltage	Green indicator extinguishes	MPPT charging is turned off
	PV high voltage	Green indicator flashes	MPPT charging is turned off
	Battery overvoltage protection	Yellow indicator flashes	MPPT charging is turned off
DC Module	DC module output overload	Red indicator is lit continuously	Fuse of DC module is blown out, and output is interrupted

## 4.4 Settings







### 4.4.1 Setting operation

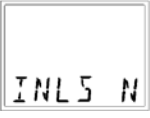

- In normal mode, press and hold “ON” + “OFF” button at the same time for 3 seconds to go to Setup mode.
- In Setup mode, press and hold “ON” + “OFF” button at the same time for 3 seconds to exit from Setup mode, and the setting are not saved.
- In Setup mode, press “ON” button for page turning to select configuration options.
- In Setup mode, press “OFF” button to configure current settings.
- In Setup mode, press “ON” button to turn to page “Save & Exit” interface, press “OFF” button and select “Y”, then press “ON” button to confirm to save datas and exsit from Setup mode.
- After the setting is configured, shut down and restart the inverter before the settings takes effect.
- In normal mode and starting state, press “OFF” button to mute.
- If there is failure and failure is solved, press “OFF” button first and release it to press “ON” button, and restart the inverter for normal use.

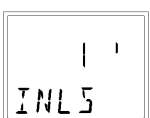
#### 4.4.2 General settings

Configure these settings at any time, using the display interface.



No.	Parameters	Default Value	Options	LCD Display
1	OUT: Rated output voltage of the inverter (option)	220V	220V / 230V / 240V	
2	INP: Input power matching of the generator (option)	120%	10% ~ 120% (based on rated power)	
3	HZ: Rated output frequency of the inverter (option)	50HZ	50HZ / 60HZ	
4	RANG: Input frequency range setting (option)	± 5%	± 5% ~ ± 15%	
5	B: Equalizing charge voltage (option)	14.1V	13.6V ~ 15.0V	
6	F: Floating charge voltage (option)	13.5V	13.2V~14.6V	
7	A: Battery low voltage alarm point setting (option)	10.8V	9.6V ~ 13.0V	
8	E: End of discharge voltage (option)	10.2V	9.6V ~ 11.5V	
9	CUR: Charging current (option)	10A (300W) 20A (600W)	0 ~ 60A	











		~3500W)		
10	IECO: Inverter no-load ECO mode Note: If select "Y", check whether the configured load rate in " Inverter shutdown load rate" is correct or not, if not, change it. (option)	N	Y / N	
11	INLS: Inverter no-load shutdown function Note: If select "Y", check whether the configured load rate in " Inverter shutdown load rate" is correct or not, if not, change it. (option)	N	Y / N	
12	INLS: Setting of the load rate of UPS auto-shutdown, The load rate of shutdown needed on the scene shall prevail during application. (Shall be taken as valid only when DC supply power) (option)	3 %	3 % ~ 50 %	
13	INLS: Setting of the delay time of UPS auto-shutdown, When load ≤ setting value, the system will shut down after the configured time. (Shall be taken as valid only in battery mode) (option)	1 min	1 ~ 99 min	
14	ACAU: AC self-starting function (option)	Y	Y / N	
15	DCAU: DC auto restart function Note: If select "Y", check whether the configured time in "DC auto restart time" is correct or not, if not, change it. (option)	N	Y / N	
16	T: DC auto restart time (option)	1H	0.5H ~ 8.0H	



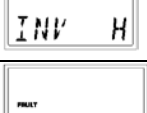

17	ITR: Input voltage display setting , displays the current rated voltage of the system; If select “100 /.../ 240”, the input voltage displays “100V /.../ 240V”, the transformer variable is <i>the</i> configured voltage value: rated voltage value. (option)	OFF	200 - 240V UPS: OFF / 100 / 110 / 115 / 120; 100 - 120V UPS: OFF / 200 / 220 / 230 / 240	
18	OTR: Output voltage display setting, displays the current rated voltage of the system; If select “100 /.../ 240”, the output voltage displays “100 V/.../240 V”, the transformer variable is the configured voltage value: rated voltage value. (option)	OFF	200 - 240V UPS: OFF / 100 / 110 / 115 / 120; 100 - 120V UPS: OFF / 200 / 220 / 230 / 240	
19	SAVE: Save and Exit		Y / N	

## 5 Troubleshooting

This section lists the status and alarm messages that the UPS might display. A suggested corrective action is listed with each display message to help you troubleshoot problems.

No.	Problem Description	Display Message	Corrective Action
1	AC output short circuit		Check if the load is short circuited.
2	AC output voltage is too high		Contact the dealer or supplier from whom it was purchased.

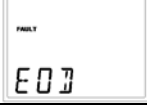
3	AC output voltage is too low		Contact the dealer or supplier from whom it was purchased.
4	Output overload		Check the load.
5	Relay fault		Contact the dealer or supplier from whom it was purchased.
6	MOSFET over-current		Contact the dealer or supplier from whom it was purchased.
7	MOS overtemperature		Decrease the operating load. Contact the dealer or supplier if the problem persists.
8	Connection of heat sink and temperature sensor abnormal		Contact the dealer or supplier from whom it was purchased.
9	Transformer overtemperature		Decrease the operating load. Contact the dealer or supplier if the problem persists.
10	Inverter AC output voltage is too high		Contact the dealer or supplier from whom it was purchased.
11	Inverter AC output voltage is too low		Contact the dealer or supplier from whom it was purchased.
12	Soft-start fault		Contact the dealer or supplier from whom it was purchased.

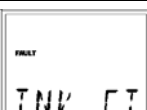
13	BUS voltage is too high (Battery is overcharged )		Check the battery voltage. Contact the dealer or supplier if the problem persists.
14	Charging over-current		Contact the dealer or supplier from whom it was purchased.
15	Battery voltage is too high		Check the battery voltage.
16	Battery over-discharge protection		Check the battery voltage
17	Fault self-locking		Wait for auto clearance or manually shut down and restart the inverter
18	CT fault		Check the CT signal line

For DC module (optional) failure, replace the DC output fuse if the red LED indicator on the DC module is illuminated.