

### Table of Contents

Title	Page
Overview	3
Unpacking Inspection	4
Safety Information	5
Rules For Safe Operation	6
International Electrical Symbols	8
The Meter Structure	9
Rotary Switch	10
Functional Buttons	11
Display Symbols	13
Measurement Ranges	15
A. Selecting a Measurement Range	15
B. Manual Ranging and Autoranging	15
Measurement Operation	17
A. AC & DC Voltage Measurement	17
B. Measuring Continuity, Diodes & Resistance	19
C. Frequency & Revolution (RPM) Measurement	22
D. DC or AC Current Measurement	24
Turning on the Display Backlight	26
The <b>BLUE</b> Button	26
The <b>RS232C</b> Button	26
Operation of Hold Mode	27
Full Icons Display	27
Sleep Mode	27
Analogue Bar Graph Display	28
General Specifications	29



**Model UT60D: OPERATING MANUAL**

	<b>Page</b>
Accuracy Specifications_____	30
A. AC Voltage_____	30
B. DC Voltage_____	30
C. Continuity, Diodes & Resistance Test_____	31
D. Frequency_____	32
E. Revolution (RPM)_____	32
F. DC Current_____	33
G. AC Current_____	33
Maintenance_____	34
A. General Service_____	34
B. Testing the Fuses_____	35
C. Replacing the Battery_____	36
D. Replacing the Fuses_____	37
RS232C Serial Port_____	38
A. RS232C Port Cable_____	38
B. Setting of RS232C Serial Ports_____	38
C. System Requirements for Installing the UT60D Interface Program_____	39

### Overview

This Operating Manual covers information on safety and cautions. Please read the relevant information carefully and observe all the **Warnings** and **Notes** strictly.



#### **Warning**

**To avoid electric shock or personal injury, read the "Safety Information" and "Rules for Safe Operation" carefully before using the Meter.**

Digital Multimeter **Model UT60D** (hereafter referred to as "the Meter") has autorange and manual range options with maximum reading 3400. The enclosure structure design adopted advanced "co-injection" technique in order to provide sufficient insulation.

In addition to the conventional measuring functions, it is equipped with a 34 segments analogue bar graph and RS232C standard serial port for easy connection with computer to realize macro recording and monitoring and capture of transient dynamic data, displaying change of waveform during the measurement, providing data and evidence to engineering technicians for scientific research. This is also a highly applied digital multimeter of good performance with full overload protection.

### Unpacking Inspection

Open the package case and take out the Meter. Check the following items carefully to see any missing or damaged part:

Item	Description	Qty
1	Operating Manual	1 piece
2	Test Lead	1 pair
3	9V Battery (NEDA1604, 6F22 or 006P) (installed)	1 piece
4	RS232C Interface Cable	1 piece
5	CD-ROM (Installation Guide & Computer Interface Software)	1 piece

In the event you find any missing or damage, please contact your dealer immediately.

### Safety Information

This Meter complies with the standards IEC61010: in pollution degree 2, overvoltage category (CAT. III 1000V, CAT. IV 600V) and double insulation.

CAT. III: Distribution level, fixed installation, with smaller transient overvoltages than CAT. IV

CAT IV: Primary supply level, overhead lines, cable systems etc.

Use the Meter only as specified in this operating manual, otherwise the protection provided by the Meter may be impaired.

In this manual, a **Warning** identifies conditions and actions that pose hazards to the user, or may damage the Meter or the equipment under test.

A **Note** identifies the information that user should pay attention on.

International electrical symbols used on the Meter and in this Operating Manual are explained on page 8.

## Rules For Safe Operation (1)

### Warning











To avoid possible electric shock or personal injury, and to avoid possible damage to the Meter or to the equipment under test, adhere to the following rules:

- 1 Before using the Meter inspect the case. Do not use the Meter if it is damaged or the case (or part of the case) is removed. Look for cracks or missing plastic. Pay attention to the insulation around the connectors.
- 1 Inspect the test leads for damaged insulation or exposed metal. Check the test leads for continuity. Replace damaged test leads with identical model number or electrical specifications before using the Meter.
- 1 Do not apply more than the rated voltage, as marked on the Meter, between the terminals or between any terminal and grounding.
- 1 The rotary switch should be placed in the right position and no any changeover of range shall be made during measurement is conducted to prevent damage of the Meter.
- 1 When the Meter working at an effective voltage over 60V in DC or 30V rms in AC, special care should be taken for there is danger of electric shock.
- 1 Use the proper terminals, function, and range for your measurements.
- 1 Do not use or store the Meter in an environment of high temperature, humidity, explosive, inflammable and strong magnetic field. The performance of the Meter may deteriorate after dampened.
- 1 When using the test leads, keep your fingers behind the finger guards.

## Rules For Safe Operation (2)

- 1 Disconnect circuit power and discharge all high-voltage capacitors before testing continuity, diodes, resistance or current.
- 1 Before measuring current, check the Meter's fuses and turn off power to the circuit before connecting the Meter to the circuit.
- 1 Replace the battery as soon as the battery indicator  appears. With a low battery, the Meter might produce false readings that can lead to electric shock and personal injury.
- 1 Remove test leads and RS232C interface cable from the Meter and turn the Meter power off before opening the Meter case.
- 1 When servicing the Meter, use only the same model number or identical electrical specifications replacement parts.
- 1 The internal circuit of the Meter shall not be altered at will to avoid damage of the Meter and any accident.
- 1 Soft cloth and mild detergent should be used to clean the surface of the Meter when servicing. No abrasive and solvent should be used to prevent the surface of the Meter from corrosion, damage and accident.
- 1 The Meter is suitable for indoor use.
- 1 Under the environment with high (+/-4kV) electrostatic discharge, the Meter may not be operated as normal condition. The user may require resetting the Meter.
- 1 Turn the Meter power off when it is not in use and take out the battery when not using for a long time.
- 1 Constantly check the battery as it may leak when it has been using for some time, replace the battery as soon as leaking appears. A leaking battery will damage the Meter.

## International Electrical Symbols

	AC (Alternating Current)
	DC (Direct Current)
	AC or DC
	Grounding
	Double Insulated
	Deficiency of Built-In Battery.
	Continuity Test.
	Diode.
	Fuse.
	Warning. Refer to the Operating Manual.
	Conforms to Standards of European Union.





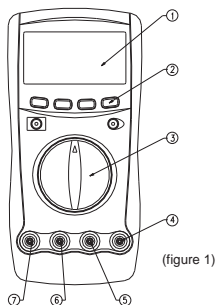





### The Meter Structure (see figure 1)



- ① LCD Display
- ② Functional Buttons
- ③ Rotary Switch
- ④ **H<sub>Z</sub>V $\Omega$**  Input Terminal:  
Input for voltage, frequency/rpm, resistance, diode and continuity measurements.
- ⑤ **COM** Input Terminal:  
Return terminal for all measurements.
- ⑥  **$\mu$ AmA** Input Terminal:  
Input for 0.1 $\mu$ A to 340.0mA current measurements.
- ⑦ **10A** Input Terminal:  
Input for 0.01A to 10.00A current measurements.









### Rotary Switch

Below table indicated for information about the rotary switch positions.







Rotary Switch Position	Function
OFF	Power is turned off
V  Hz	DC voltage measurement range from 340.0mV to 1000V or AC voltage measurement range from 3.400V to 750.0V.
  $\Omega$	 Continuity test.  Diode test. $\Omega$ Resistance measurement range from 340.0 $\Omega$ to 34.00M $\Omega$ .
HzRPM	Frequency measurement range from 3.400KHz to 34.00MHz or RPM measurement.
$\mu$ A  Hz	AC or DC current measurement range from 340.0 $\mu$ A to 3400 $\mu$ A.
mA  Hz	AC or DC current measurement range from 34.00mA to 340.0mA.
Hz  A	AC or DC current measurement 10.00A.

## Functional Buttons (1)

Below table indicated for information about the functional button operations.

Button	Measuring Function	Operation Performed
	Display Backlight	Press  once to turn the Display Backlight on and it shall shut off automatically in 10 seconds later.
 (BLUE)	 Hz	Switches between AC and DC voltage; the Meter beeps. DC is default.
	 $\Omega$ $\rightarrow$	Switches between continuity and diode and resistance measurements; the Meter beeps. Resistance is default.
	HzRPM	Switches between Hz unit display and RPM unit display; the Meter beeps. This function is suitable for RPM $\rightarrow$ Frequency interchanging measurement.
	 Hz	Switches between AC and DC current range from 340.0uA to 3400uA; the Meter beeps. DC is default.
	 Hz	Switches between AC and DC current range from 34.00mA to 340.0mA; the Meter beeps. DC is default.
	 A	Switches between AC and DC current 10.00A; the Meter beeps. DC is default.
Hz	DC/AC voltage or DC/AC current	1. Press to start the frequency counter; the Meter beeps. 2. Press again to return to the previous measurement mode; the Meter beeps.

### Functional Buttons (2)

	At <b>OFF</b> position	Press <b>H<sub>z</sub></b> button while turning on the Meter to disable Sleep Mode feature.
<b>RANGE</b>	Any rotary switch position except at  ,  and <b>A<math>\tilde{\sim}</math></b> mode.	<ol style="list-style-type: none"> <li>1. Press <b>RANGE</b> to enter the manual ranging mode; the Meter beeps. Manually selecting a range causes the Meter to exit the Hold mode.</li> <li>2. Press <b>RANGE</b> to step through the ranges available for the selected function; the Meter beeps.</li> <li>3. Press and hold <b>RANGE</b> for over 1 second to return to autoranging; the Meter beeps.</li> </ol>
	At <b>OFF</b> position	Press <b>RANGE</b> button while turning on the Meter to disable Sleep Mode feature.
<b>RS232C</b>	Any rotary switch position	Turn on or off the serial port interface without changing the original setting.
	At <b>OFF</b> position	Press <b>RS232C</b> button while turning on the Meter to disable Sleep Mode feature.
<b>HOLD</b> 	Any rotary switch position	Press <b>HOLD</b>  to enter and exit the Hold mode in any mode, the Meter beeps.
	At <b>OFF</b> position	<ol style="list-style-type: none"> <li>1 Press and hold <b>HOLD</b> button while turning on the Meter to display full icons.</li> <li>1 Press <b>HOLD</b> again to return to normal display mode.</li> </ol>

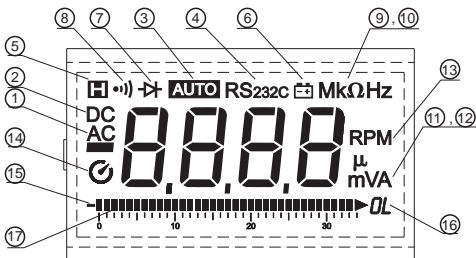

### Display Symbols (1) (see figure 2)



(figure 2)

Number	Symbol	Meaning
①	AC	Indicator for AC voltage or current. The displayed value is the mean value.
②	DC	Indicator for DC voltage or current.
③	<b>AUTO</b>	The Meter is in the auto range mode in which the Meter automatically selects the range with the best resolution.
④	<b>RS232C</b>	Data output is in progress.
⑤	<b>H</b>	Data hold is active.
⑥	<b>⚡</b>	The battery is low. <b>⚠ Warning: To avoid false readings, which could lead to possible electric shock or personal injury, replace the battery as soon as the battery indicator appears.</b>
⑦	<b>→ </b>	Test of diode.
⑧	<b>•  )</b>	The continuity buzzer is on.

### Display Symbols (2) (see figure 2)

⑨	$\Omega$ , $k\Omega$ , $M\Omega$	$\Omega$ : Ohm. The unit of resistance. $k\Omega$ : kilohm. $1 \times 10^3$ or 1000 ohms. $M\Omega$ : Megaohm. $1 \times 10^6$ or 1,000,000 ohms.
⑩	Hz, kHz, MHz	Hz : Hertz. The unit of frequency in cycles/second. kHz : Kilohertz. $1 \times 10^3$ or 1,000 hertz. MHz: Megahertz. $1 \times 10^6$ or 1,000,000 hertz.
⑪	V, mV	V : Volts. The unit of voltage. mV : Millivolt. $1 \times 10^{-3}$ or 0.001 volts.
⑫	A, mA, $\mu A$	A : Amperes (amps). The unit of current. mA : Milliamp. $1 \times 10^{-3}$ or 0.001 amperes. $\mu A$ : Microamp. $1 \times 10^{-6}$ or 0.000001 amperes.
⑬	RPM	Revolution Measurement. The unit: rev./min.
⑭		Sleep Mode feature is enabled. It can be disabled by pressing <b>RANGE</b> , <b>Hz</b> or <b>RS232C</b> when turning on the Meter.
⑮		Indicates negative reading.
⑯	<b>OL</b>	The input value is too large for the selected range.
⑰		Analogue bar graph display.

## Measurement Ranges (1)

A measurement range determines the highest value the Meter can measure. Most Meter functions have more than one range. See "Accuracy Specifications."

### A. Selecting a Measurement Range

Being in the right measurement range is important:

- 1 If the range is too low for the input, the Meter displays **OL** to indicate an overload.
- 1 If the range is too high, the Meter will not display the most accurate measurement.

### B. Manual Ranging and Autoranging

The Meter has both manual range and autorange options:

- 1 In the autorange mode, the Meter selects the best range for the input detected.  
This allows you to switch test points without having to reset the range.
- 1 In the manual range mode, you select the range.  
This allows you to override autorange and lock the Meter in a specific range.

The Meter defaults to the autorange mode in measurement functions that have more than one range. When the Meter is in the autorange mode, **AUTO** is displayed.

To enter and exit the manual range mode:

1. Press **RANGE**.  
The Meter enters the manual range mode and **AUTO** turns off.  
Each presses of **RANGE** increments the range. When the highest range is reached, the Meter wraps to the lowest range.

## Measurement Ranges (2)

2. To exit the manual range mode, press and hold **RANGE** for over one second.  
The Meter returns to the autorange mode and **AUTO** is displayed.

### Note

- 1 If you manually change the measurement range after entering Hold mode, the Meter exits this mode.
- 1 Under diode, continuity and A range measurement, only manual range mode is available.



### Measurement Operation (1)

#### A. AC & DC Voltage Measurement

##### Warning

To avoid harms to you or damages to the Meter from electric shock, please do not attempt to measure voltages higher than DC1000V / AC750V rms, although readings may be obtained.

AC Voltage Measurement (see figure 3)

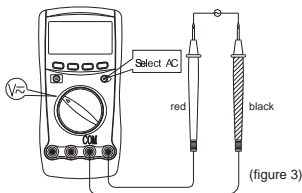

The AC voltage ranges are: 3.400V, 34.00V, 340.0V and 750.0V. To measure AC Voltage, connect the Meter as follows:

1. Insert the red test lead into the **HzVΩ** terminal and the black test lead into the **COM** terminal.
2. Set the rotary switch to **V~Hz** and press **BLUE** button to select AC measurement mode.
3. Connect the test leads across with the object being measured.

The measured value shows on the display, which is effective value of sine wave (mean value response).

#### Note

- 1 In each range, the Meter has an input impedance of 10MΩ. This loading effect can cause measurement errors in high impedance circuits. If the circuit impedance is less than or equal to 10kΩ, the error is negligible (0.1% or less).

### Measurement Operation (2)

- 1 When AC voltage measurement has been completed, disconnect the connection between the testing leads and the circuit under test.

#### DC Voltage Measurement (see figure 4)

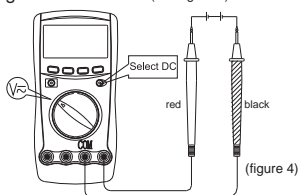

The DC Voltage ranges are: 340.0mV, 3.400V, 34.00V, 340.0V and 1000V. To measure DC voltage, connect the Meter as follows:

1. Insert the red test lead into the **HzVΩ** terminal and the black test lead into the **COM** terminal.
2. Set the rotary switch to **V~Hz**; DC measurement is default or press **BLUE** button to select DC measurement mode.
3. Connect the test leads across with the object being measured.

The measured value shows on the display.

#### Note

- 1 In each range, the Meter has an input impedance of  $10M\Omega$ . This loading effect can cause measurement errors in high impedance circuits. If the circuit impedance is less than or equal to  $10k\Omega$  the error is negligible (0.1% or less).
- 1 When DC voltage measurement has been completed, disconnect the connection between the testing leads and the circuit under test.

## Measurement Operation (3)

### B. Measuring Continuity, Diodes & Resistance

#### Warning

To avoid damages to the Meter or to the devices under test, disconnect circuit power and discharge all the high-voltage capacitors before measuring continuity, diodes & resistance.

Testing for Continuity (see figure 5)

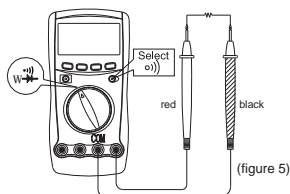

To test for continuity, connect the Meter as below:

1. Insert the red test lead into the **HzVΩ** terminal and the black test lead into the **COM** terminal.
2. Set the rotary switch to  $\Omega$  and press **BLUE** button to select measurement mode.
3. The buzzer sounds if the resistance of a circuit under test is less than  $50\Omega$ .

#### Note

- 1 The LCD displays **OL** indicating the circuit being tested is open.
- 1 When continuity testing has been completed, disconnect the connection between the testing leads and the circuit under test.

### Measurement Operation (4)

Testing Diodes (see figure 6)

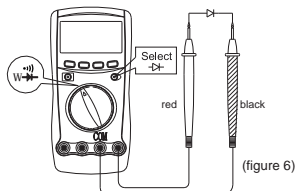

Use the diode test to check diodes, transistors, and other semiconductor devices. The diode test sends a current through the semiconductor junction, then measures the voltage drop across the junction. A good silicon junction drops between 0.5V and 0.8V.

To test a diode out of a circuit, connect the Meter as follows:

1. Insert the red test lead into the **HzVΩ** terminal and the black test lead into the **COM** terminal.
2. Set the rotary switch to  $\Omega \rightarrow \text{diode symbol}$  and press **BLUE** button to select  $\rightarrow$  measurement mode.
3. For forward voltage drop readings on any semiconductor component, place the red test lead on the component's anode and place the black test lead on the component's cathode.  
The measured value shows on the display.

#### Note

- 1 In a circuit, a good diode should still produce a forward voltage drop reading of 0.5V to 0.8V; however, the reverse voltage drop reading can vary depending on the resistance of other pathways between the probe tips.

### Measurement Operation (5)

- 1 Connect the test leads to the proper terminals as said above to avoid error display.
- 1 The LCD will display **OL** indicating open-circuit for wrong connection.
- 1 The unit of diode is Volt (V), displaying the positive-connection voltage-drop value.
- 1 When diode testing has been completed, disconnect the connection between the testing leads and the circuit under test.

### Resistance Measurement (see figure 7)

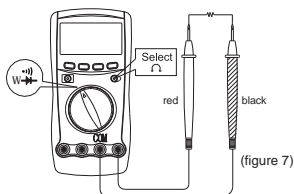

The resistance ranges are: 3.400kΩ, 34.00kΩ, 340.0kΩ, 3.400MΩ and 34.00MΩ . To measure resistance, connect the Meter as follows:

1. Insert the red test lead into the **H<sub>Z</sub>VΩ** terminal and the black test lead into the **COM** terminal.
2. Set the rotary switch to **Ω** (→), resistance measurement (Ω) is default or press **BLUE** button to select Ω measurement mode.
3. Connect the test leads across with the object being measured.

The measured value shows on the display.

## Measurement Operation (6)

### Note

- 1 The test leads can add  $0.1\Omega$  to  $0.2\Omega$  of error to resistance measurement. To obtain precision readings in low-resistance measurement, that is the range of  $340.0\Omega$ , short-circuit the input terminals beforehand and record the reading obtained (called this reading as X). (X) is the additional resistance from the test lead.

Then use the equation:

measured resistance value (Y) - (X) = precision readings of resistance.

- 1 For high-resistance measurement ( $>1M\Omega$ ), it is normal taking several seconds to obtain a stable reading.
- 1 If  $\Omega$  reading with shorted test leads is not  $\leq 0.5\Omega$ , check for loose test leads, incorrect function selection, or enabled Data Hold function.
- 1 The LCD displays **OL** indicating open-circuit for the tested resistor or the resistor value is higher than the maximum range of the Meter.
- 1 When resistance measurement has been completed, disconnect the connection between the testing leads and the circuit under test.

## C. Frequency & Revolution (RPM) Measurement

(see figure 8)

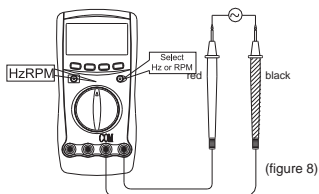

## Measurement Operation (7)

The frequency measurement ranges are :3.4kHz, 34kHz, 340kHz, 3.4MHz, 34MHz. To measure frequency, connect the Meter as follows:

1. Insert the red test lead into the **HzV $\Omega$**  terminal and the black test lead into the **COM** terminal.
2. Set the rotary switch to **HzRPM**; frequency measurement (Hz) is default or press **Hz** to select Hz measurement mode when it is under **V $\sim$ Hz**,  **$\mu$ A $\sim$ Hz**, **mA $\sim$ Hz** or **Hz $\sim$ A** range.
3. Connect the test leads across with the object being measured.  
The measured value shows on the display.
4. At **HzRPM** range, revolution unit can be displayed by pressing **BLUE** button until the RPM symbol is shown on the display.  
Press **BLUE** button again to return to frequency unit display.

### Note

- 1 To obtain a stable reading when measuring:
  - Input scope  $\geq 30V$  rms frequency signal:  
Set the rotary switch to **V $\sim$ Hz**,  **$\mu$ A $\sim$ Hz**, **mA $\sim$ Hz** or **Hz $\sim$ A**.  
Then press **Hz** to select Hz measurement mode to obtain frequency value.  
Press **RANGE** at that time can change the frequency sensitivity.
  - Input scope  $< 30V$  rms frequency signal:  
Follow the above step 2 carrying out the measurement.
- 1 When Hz measurement has been completed, disconnect the connection between the testing leads and the circuit under test.

## Measurement Operation (8)

### D. DC or AC Current Measurement (see figure 9)

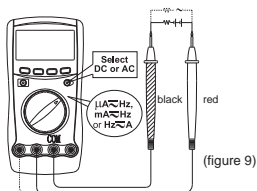

#### Warning

Never attempt an in-circuit current measurement where the open-circuit voltage between the circuit and ground is greater than 250V.

If the fuse burns out during measurement, the Meter may be damaged or the operator himself may be hurt. Use proper terminals, function, and range for the measurement. When the testing leads are connected to the current terminals, do not parallel them across any circuit.

The current measurement has 3 measurement positions on the rotary switch:  $\mu\text{A} \sim \text{Hz}$ ,  $\text{mA} \sim \text{Hz}$  or  $\text{Hz} \sim \text{A}$ .

The  $\mu\text{A} \sim \text{Hz}$  has a 340.0 $\mu\text{A}$  and 3400 $\mu\text{A}$  range, with auto ranging; the  $\text{mA} \sim \text{Hz}$  has a 34.00mA and 340.0mA range, with auto ranging;  $\text{Hz} \sim \text{A}$  position has only a 10.00A range, with manual ranging only.

To measure current, do the following:

1. Turn off power to the circuit. Discharge all high-voltage capacitors.
2. Insert the red test lead into the  $\mu\text{mA}$  or 10A or terminal and the black test lead into the COM terminal.



### Measurement Operation (9)

3. Set the rotary switch to  $\mu\text{A}\sim\text{Hz}$ ,  $\text{mA}\sim\text{Hz}$  or  $\text{Hz}\sim\text{A}$ . Use the **10A** terminal and  $\text{Hz}\sim\text{A}$  measurement position if the current value to be tested is an unknown.
4. The Meter defaults to DC current measurement mode. To toggle between DC and AC current measurement function, press **BLUE** button. AC current is displayed as an mean value (calibrated against sine wave effective value).
5. Break the current path to be tested. Connect the red test lead to the more positive side of the break and the black test lead to the more negative side of the break.
6. Turn on power to the circuit.  
The measured value shows on the display.

#### Note

- 1 For safety sake, the measuring time for high current should be  $\leq 10$  seconds for each measurement and the interval time between 2 measurements should be greater than 15 minutes.
- 1 When current measurement has been completed, disconnect the connection between the testing leads and the circuit under test.

## Turning on the Display Backlight



### Warning

In order to avoid the hazard arising from mistaken readings in insufficient light or poor vision, please use Display Backlight function.

- 1 Press  once to turn the Display Backlight on.
- 1 Display Backlight will automatically shut off in about 10 seconds later.

## The BLUE button

It uses for selecting the required measurement function when there is more than one function at one position of the rotary switch.

## The RS232C button

Press **RS232C** to enter or exit data output mode.

In RS232C serial port data output mode, if the Meter is under the Hold operation, the Meter will display the corresponding operation's data. However, the serial port output the instantaneous data from the input terminals.



In RS232C serial port data output mode, the Sleep Mode function will be disabled.

### Operation of Hold Mode



#### Warning

To avoid possibility of electric shock, do not use Hold mode to determine if circuits are without power. The Hold mode will not capture unstable or noisy readings.



The Hold mode is applicable to all measurement functions.

- 1 Press **HOLD**  to enter Hold mode; the Meter beeps.
- 1 Press **HOLD**  again or **RANGE** or turn the rotary switch to exit Hold mode; the Meter beeps.
- 1 In Hold mode,  is displayed.

### Full Icons Display

If the Meter is turned on with **HOLD**  being pressed on, the LCD will display all the icons and maintain this mode until the LCD enters normal display mode when the **HOLD**  is pressed again.

### Sleep Mode







- 1 To preserve battery life, the Meter automatically turns off if you do not turn the rotary switch or press any button for 10 minutes.
- 1 The Meter can be activated by turning the rotary switch or pressing any button other than .
- 1 The Meter will display the last measurement value before it entered Sleep Mode if it is activated by pressing any button other than  and it was not in the continuity measurement mode before it entered Sleep Mode.  
If the Meter is activated by turning the rotary switch, it will start from the switch selected function.
- 1 To disable the Sleep Mode, press **Hz**, **RANGE** or **RS232C** button while turning on the Meter.

### **Analogue Bar Graph Display**

The analogue bar graph likes the needle in a traditional analogue meter (AMM). It refreshes 10 times a sec, which is much faster than that of digital display and is applied to zero adjustment and observation of rapidly changing signal that make digital display hard to read.

The analogue display is divided uniformly into 10 scales and composed of 34 segments; of which the full-range value corresponds to the full-range value of the measurement range that has been selected. The polarity of the measured value is displayed as "-" on the left of the analogue display: positive polarity is not displayed. For example, when 34V range is selected, the full-range value of the analogue display is 34V, and as the full range is uniformly divided into 34 grades, each grade denotes 1V. If the input is 17V, the high-lighted bar-shape will be at the position indicated by the number 17. if the input is -17V, a "-" sign will appear on the left of the analogue display.

### General Specifications

- 1 Maximum Voltage : 1000V rms.  
between any Terminals  
and Grounding
- 1  Fused Protection for : 0.5A,250V fast type Glass  
 $\mu$ AmA Input Terminal fuse,  $\phi$ 5x20mm
- 1  Fused Protection for : 10A,250V fast type Glass  
10A Input Terminal fuse,  $\phi$ 5x20mm
- 1 Maximum Display : Display: 3400 and 34  
segments analogue bar  
graph.
- 1 Measurement Speed : Updates 3 times /second.
- 1 Temperature: Operating : 0°C~40°C (32°F ~104 °F).  
Storage : -10°C~50°C (14°F~122°F).
- 1 Relative Humidity :  $\leq$ 75% @ 0°C - 30°C;  
 $\leq$ 50% @ 31°C - 40°C.
- 1 Altitude: Operating : 2000 m; Storage:10000 m.
- 1 Battery Type : One piece of 9V  
NEDA1604 or 6F22 or  
006P.
- 1 Battery Deficiency : Display .
- 1 Data Holding : Display .
- 1 Negative reading : Display .
- 1 Overloading : Display **OL**.
- 1 Equipped with full icons display.
- 1 Auto and manual range selectable.
- 1 Dimensions (HxWxL) : 177 x 85 x 40 mm.
- 1 Weight : Approximate 300g (battery  
included).
- 1 Safety/Compliances : IEC61010 CAT.III 1000V,  
CAT.IV 600V overvoltage  
and double insulation  
standard.
- 1 Certification :  ,UL & CUL

## Accuracy Specifications (1)

Accuracy:  $\pm(a\% \text{ reading} + b \text{ digits})$ , guarantee for 1 year.

Operating temperature:  $23^{\circ}\text{C} \pm 5^{\circ}\text{C}$ .

Relative humidity:  $<75\%$ .

Temperature coefficient:  $0.1 \times (\text{specified accuracy}) / 1^{\circ}\text{C}$ .

### A. AC Voltage

Range	Resolution	Accuracy
3.4V	1mV	$\pm(1.5\%+3)$
34V	10mV	[If the signal frequency being measured $\geq 10\text{kHz}$ , accuracy: $\pm 4\%+4$
340V	100mV	
750V	1V	$\pm(2.5\%+3)$

#### Remarks:

- 1 Input impedance  $\geq 10\text{M}\Omega$  .
- 1 Displays effective value of sine wave (mean value response).
- 1 Frequency response:  
 $<34\text{V}$ : 45Hz ~ 20kHz, -3dB can reach 1000kHz.  
 $\geq 34\text{V}$ : 45Hz ~ 1kHz, -3dB can reach 30kHz.

### B. DC Voltage

Range	Resolution	Accuracy	Overload Protection
340mV	0.1mV	$\pm(0.8\%+3)$	1000V DC 750V AC rms continuous.
3.4V	1mV	$\pm(0.8\%+1)$	
34V	10mV		
340V	100mV		
1000V	1V	$\pm(1\%+3)$	

**Remark:** Input impedance  $\geq 10\text{M}\Omega$  .

## Accuracy Specifications (2)

### C. Continuity, Diodes & Resistance Test

Range	Resolution	Accuracy	Overload Protection
Continuity Test (340.0Ω)	0.1Ω	Approximate ≤ 50Ω	600Vp
Diode	1mV	N/A	
340Ω	0.1Ω	±(1.2%+2)+short circuit resistance	
3.4kΩ	1Ω	±(1%+2)	
34kΩ	10Ω		
340kΩ	100Ω		
3.4MΩ	1kΩ	±(1.2%+2)	
34MΩ	10kΩ	±(1.5%+2)	

#### Remarks:

- 1 **Continuity Test 340.0Ω Range:**  
Buzzer beeps continuously.  
Open circuit voltage approximate 1.2V.
- 1 **Diode Range:**  
Open circuit voltage approximate 2.8V.  
Displays approximate forward current drop reading 1mA.
- 1 **340Ω Range:**  
Open circuit voltage approximate 1.2V.
- 1 **3.4kΩ~ 34MΩ Range:**  
Open circuit voltage approximate 0.5V.

## Accuracy Specifications (3)

### D. Frequency

Range	Resolution	Accuracy	Overload Protection
3.4kHz	1Hz	±(0.2%+2)	600Vp
34kHz	10Hz		
340kHz	100Hz		
3.4MHz	1kHz		
34MHz	10kHz		

#### Remarks:

- 1 100mV ≤ Input amplitude ≤ 30V rms.
- 1 At voltage and current range (VAHz):

Range	Accuracy
10Hz~1kHz	±(2%+3)

Input amplitude: ≥1000 digits.

### E. Revolution (RPM)

Range	Resolution	Accuracy	Overload Protection
34k	0.01k	±(0.2%+2)	600Vp
340k	0.1k		
3.4M	1k		
34M	10k		
340M	100k		

#### Remark:

- 1 100mV ≤ Input amplitude ≤ 30V rms.



## Accuracy Specifications (4)

### F. DC Current

Range	Resolution	Accuracy	Overload Protection
340μA	0.1μA	±(1.2%+2)	0.5A, 250V, fast type Glass fuse, φ5x20 mm.
3400μA	1μA		
34mA	10μA		
340mA	100μA		
10A	10mA	±(1.5%+2)	10A, 250V, fast type Glass fuse, φ5x20 mm.

**Remark:**

1 **10A Range:**

For continuous measurement ≤10 seconds and interval time between 2 measurements greater than 15 minutes.

### G. AC Current

Range	Resolution	Accuracy	Overload Protection
340μA	0.1μA	±(1.5%+5)	0.5A, 250V, fast type Glass fuse, φ5x20 mm.
3400μA	1μA		
34mA	10μA		
340mA	100μA		
10A	10mA	±(2.5%+5)	10A, 250V, fast type Glass fuse, φ5x20 mm.

**Remarks:**

1 Frequency response 40Hz ~ 1kHz.

1 Displays effective value of sine wave (mean value response).

1 **10A Range:**

For continuous measurement ≤10 seconds and interval time between 2 measurements greater than 15 minutes.

## Maintenance (1)

This section provides basic maintenance information including battery and fuse replacement instruction.



### Warning

**Do not attempt to repair or service your Meter unless you are qualified to do so and have the relevant calibration, performance test, and service information. To avoid electrical shock or damage to the Meter, do not get water inside the case.**

#### A. General Service

- 1 Periodically wipe the case with a damp cloth and mild detergent. Do not use abrasives or solvents.
- 1 To clean the terminals with cotton bar with detergent, as dirt or moisture in the terminals can affect readings.
- 1 Turn the Meter to **OFF** position when it is not in use and take out the battery when not using for a long time.
- 1 Do not store the Meter in a place of humidity, high temperature and strong magnetic field.

## Maintenance (2)

### B. Testing the Fuses



#### Warning

To avoid electrical shock or personal injury, remove the test leads and any input signals before replacing the battery or fuse.

To prevent damage or injury, install **ONLY** replacement fuses with identical amperage, voltage, and speed ratings.

To test the fuse:

1. Set the rotary switch to  $\Omega$   $\rightarrow$   $\rightarrow$  and select  $\rightarrow$  by pressing **BLUE** button.
2. Plug a test lead into the terminal **H<sub>z</sub>V $\Omega$**  and touch the probe tip to the **10A** or  **$\mu$ AmA** terminal.
  - 1 If the Meter beeps, the fuse is good.
  - 1 If the display shows **OL**, replace the fuse and test again.
  - 1 If the display shows any other value, have the Meter serviced and contact your dealer immediately.

If the Meter does not work while the fuse is all right, send it to your dealer for repair.

## Maintenance (3)

### C. Replacing the Battery (see figure 10)

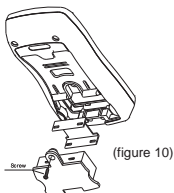

#### Warning

To avoid false readings, which could lead to possible electric shock or personal injury, replace the battery as soon as the battery indicator "  " appears.

To replace the battery:

1. Turn the Meter to **OFF** position and remove all connections from the terminals.
2. Remove the screw from the battery compartment, and separate the battery compartment from the case bottom.
3. Remove the battery from the battery compartment.
4. Replace the battery with a new 9V battery (NEDA1604, 6F22 or 006P).
5. Rejoin the case bottom and battery compartment, and reinstall the screw.

## Maintenance (4)

### D. Replacing the Fuses (see figure 11)

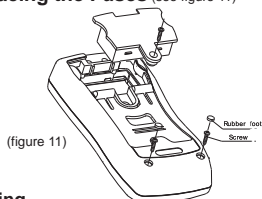

#### Warning

To avoid electrical shock or arc blast, or personal injury or damage to the Meter, use specified fuses **ONLY** in accordance with the following procedure.

To replace the Meter's fuse:

1. Turn the Meter to **OFF** position and remove all connections from the terminals.
2. Remove the screw from the battery compartment, and separate the battery compartment from the case bottom.
3. Remove the 2 rubber feet and 2 screws from the case bottom, and separate the case top from the case bottom.
4. Remove the fuse by gently prying one end loose, then take out the fuse from its bracket.
5. Install **ONLY** replacement fuses with the identical type and specification as follows and make sure the fuse is fixed firmly in the bracket.

Fuse 1: 0.5A, 250V, fast type Glass fuse,  
 $\phi$  5x20mm.

Fuse 2: 10A, 250V, fast type Glass fuse,  
 $\phi$  5x20 mm.

### Maintenance (5)

6. Rejoin the battery compartment and the case top, and reinstall the screw.
7. Rejoin the case bottom and case top, and reinstall the 2 screws and 2 rubber feet.

Replacement of the fuses is seldom required. Burning of a fuse always results from improper operation.

### RS232C Serial Port (1)

#### A. RS232C Port Cable

The Meter		Computer			
D-sub 9 Pin Male		D-sub 9 Pin Female	D-sub 25 Pin Female	Pin Name	Remark
2	---	2	3	RX	Receiving Data
3	---	3	2	TX	Transmitting Data
4	---	4	20	DTR	Data Terminal Ready
5	---	5	7	GND	Grounding
6	---	6	6	DSR	Data Set Ready
7	---	7	4	RTS	Request To Send
8	---	8	5	CTS	Clear To Send

#### B. Setting of RS232C Serial Ports

Default of RS232C serial port for communication is set as:

Baud Rate	2400
Start bit	1 (always 0)
Stop bit	1 (always 1)
Data bits	7
Parity	1 (odd)

## RS232C Serial Port (2)

### C. System Requirements for Installing the UT60D Interface Program

To use **UT60D Interface Program**, you need the following hardware and software:

- 1 An IBM PC or equivalent computer with 80486 or higher processor and 640 x 480 pixel or better monitor.
- 1 Microsoft Windows 95 or above.
- 1 At least 8MB of RAM.
- 1 At least 8MB free space in hard drive.
- 1 Can access to a local or a network CD-ROM.
- 1 A free serial port.
- 1 A mouse or other pointing device supported by Windows.

Please refer to the included "**Installation Guide & Computer Interface Software**" for installing and operating instructions of the **UT60D Interface Program**.

~ END ~

This operating manual is subject to change without notice.

**UNI-T®**

**Model UT60D: OPERATING MANUAL**



**UNI-T®**

**Model UT60D: OPERATING MANUAL**



**Model UT60D: OPERATING MANUAL**

©Copyright 2001 Uni-Trend International Limited.  
All rights reserved.

Manufacturer: UNI-TREND TECHNOLOGY(DONG GUAN)LIMITED  
Address: Dong Fang Da Dao, Bei Shan Dong Fang Industrial  
Development District, Hu Men Town, Dong Guan City,  
Guang Dong Province, China

Headquarters: Uni-Trend International Limited  
Address: Rm901, 9/F, Nanyang Plaza 57 Hung To Road  
Kwun Tong Kowloon, Hong Kong

Tel: (852) 2950 9168  
Fax: (852) 2950 9303  
Email: [info@uni-trend.com](mailto:info@uni-trend.com)  
<http://www.uni-trend.com>