

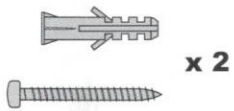

Elevation
Design





+

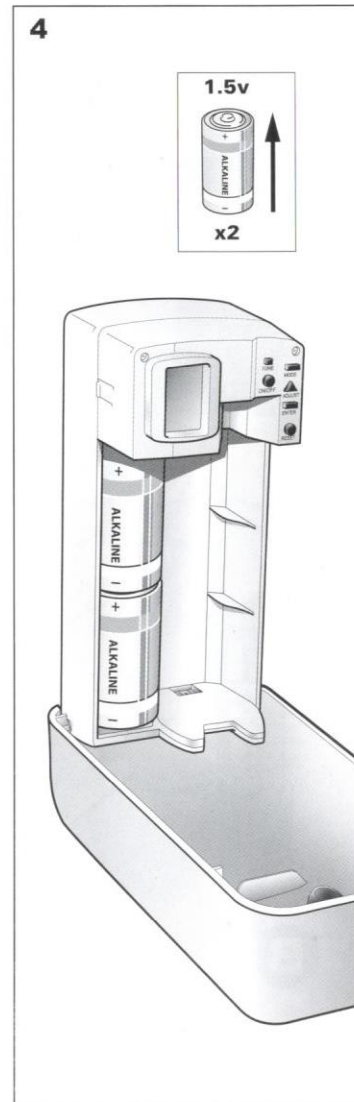
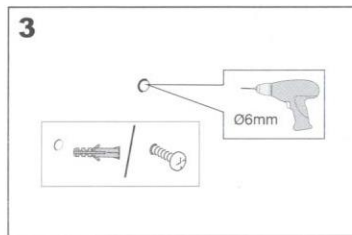
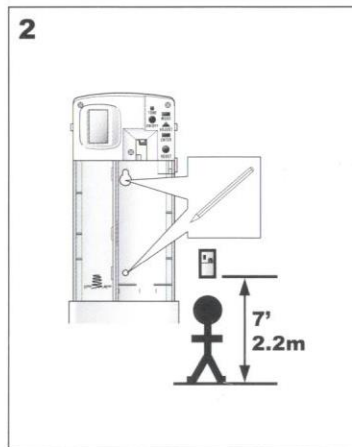
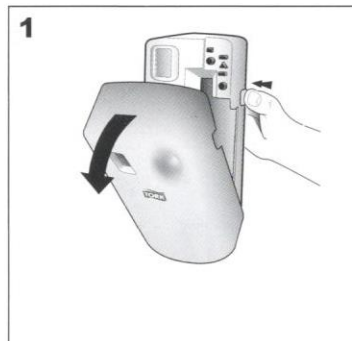
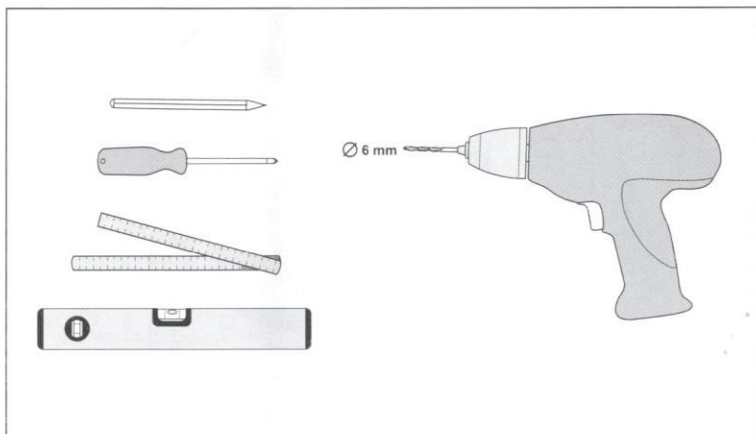

5

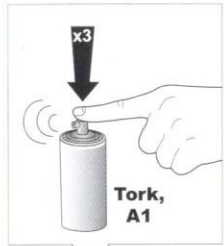

Tork, A1

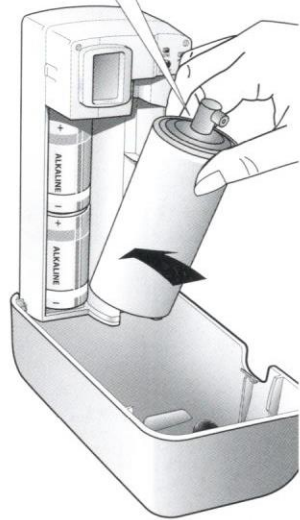

6

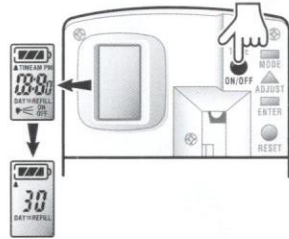

7

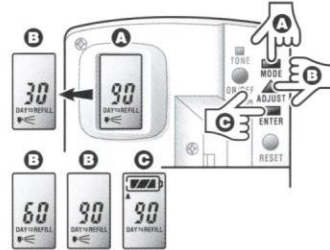

8

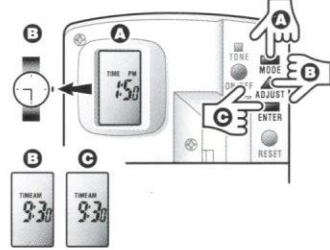

9

8hr / 12hr / 16hr / 24hr ?

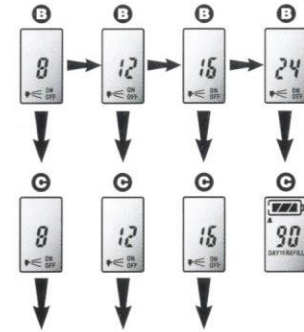
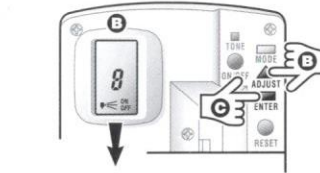

8hr / 12hr / 16hr

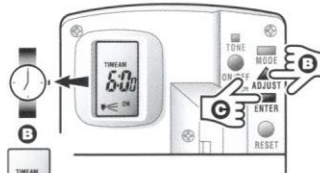

10

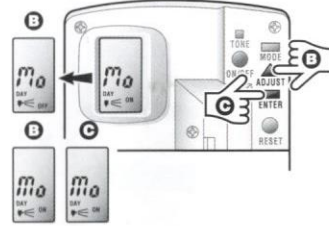
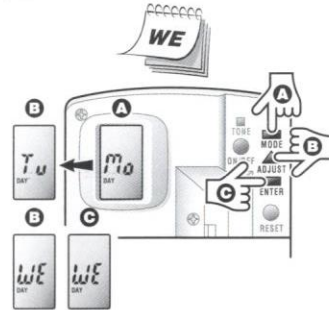

ma	Lun - Mo - Lun - Seg - Lu - ma - ma - Aeut. - Pon. - Di - Po - Po - H - E - Pirmd - P	fr	Ven - Fr - Ven - Sex - Vi - pe - fr - Flop. - Pt. - ITT - Pa - Pi - P - R - Plektd - Pn
Tu	Mar - Di - Mar - Ter - Ma - ti - To - We - BT - Ut - Ut - K - T - O - A	Sa	Sam - Sa - Sab - Sab - Sa - la - 10 - 2ab - Sob. - CS - So - So - Szo - L - S - S
We	Mer - Mi - Mer - Qua - Mi - ke - on - Tet. - Sr - CP - St - St - Sze - K - T - T	Su	Dim - So - Dom - Dom - Do - su - so - Kup. - Niedz. - BC - Ne - Ne - V - P - Sv - S
Ta	Jeu - Do - Gio - Qui - Ju - to - to - Flej. - Czw. - 4T - Ct - St - Cs - N - C - K		

11

