

**SANY**<sup>®</sup>

# SPECIFICATION



**160t**



**75.5m**



**102.5m**

# STC1600T7

**SANY TRUCK CRANE**

QUALITY CHANGES THE WORLD

[crane.sanyglobal.com](http://crane.sanyglobal.com)

V1.1

It is one of the core business units in SANY Group, specializing in the development and manufacturing of high-end wheel cranes, crawler cranes and tower cranes, including the complete range of wheel cranes from 8 to 2200t, crawler cranes from 25 to 4500t and tower cranes from 6 to 185t.

三一集团旗下核心事业部，从事高端轮式起重机、履带起重机、塔式起重机系列产品的研发制造。覆盖8-2200吨全吨位轮式起重机，25-4500吨全吨位履带起重机，6-185吨塔式起重机。



SANY CRANE



# STC1600T7

SANY TRUCK CRANE  
160T LIFTING CAPACITY

STC1600T7 is a truck crane with 160t lifting capacity, 7 section 75.5m boom, wireless remote control of counterweight lifting, superstructure slewing and outrigger telescoping, standard winch follower and one-key boom telescoping.

STC1600T7一款最大起重量160吨、7节臂、最大主臂长75.5米的汽车起重机。配重升降、上车回转、支腿伸缩均可远程遥控，标配卷扬随动、起重臂一键伸缩。



## 75.5m Boom

Boom full extension 75.5m

## 75.5m主臂

主臂全伸最长75.5m

## Wireless Remote Control

Wireless remote control available for CW lifting, superstructure slewing and outrigger telescoping

## 无线遥控

配重提放、上车回转、支腿伸缩均可远程遥控



## Strong Bearing Chassis

H-outriggers and high-strength rectangular cross-section frame

### 高承载能力底盘

H 型活动支腿 + 高强度矩形截面车架

## SANY Adjustable Counterweight Technology

SANY self-developed adjustable counterweight technology, the CW lifting cylinder can move 550mm back and forth

### 三一配重变位技术

三一自创配重变位技术，配重提升油缸可前后移动 550mm

## SANY TRUCK CRANE STC1600T7-1 / 160T LIFTING CAPACITY

### Boom system

#### 臂架结构

Oval shape large cross section boom 75.5m in full length, fixed jib 17.5m, 9.5m extension optional, leading in industry.

Max. lifting moment of basic boom 5145kN·m, max. lifting moment of full extension boom 2234kN·m. Max. load 9.2t at full extension boom.

大截面卵型主臂,全伸臂长75.5m,副臂长17.5m,可选9.5m延伸臂,行业领先。  
基本臂最大起重力矩5145kN·m,全伸臂最大起重力矩2234kN·m,全伸臂最大吊重9.2t。



### Integrated remote control

#### 集成遥控技术

The remote control panel integrating counterweight lifting, turntable slewing, jib deployment, cab side step telescoping, outrigger telescoping, one-key leveling.

集成配重提拉、转台回转、副臂收展、操纵室踏板伸缩、支腿伸缩、一键调平。





## Chassis

### 车架底盘

New 3m wide chassis, H type outriggers and high-strength rectangular cross-section frame, improving torsion and bending resistance and working convenience.

HANDE heavy-duty axles, the max. gradeability 45%, fuel consumption per 100 km 50L, able to travel slowly with 23t counterweight + 4 outrigger pads on board in short distance.

All axles are equipped with high-efficiency drum brake, highly efficient and reliable.

G-class chassis; ground clearance 310mm, approach/departure angle 17°/17°, better travel flexibility. Equipped with 450L large volume fuel reservoir with excellent endurance mileage.

全新 3m 宽底盘，H 型活动支腿 + 高强度矩形截面车架，提升吊载抗扭抗弯能力和作业便利性。

汉德重承载车桥，最大爬坡度 45%，百公里油耗 50L，可带 23t 配重 + 4 块支腿垫板短距离低速转场。

全桥配置大尺寸鼓式制动器，制动效率更高，更可靠。

G 类车；离地间隙 310mm，接近 / 离去角 17/17°，通过性优越。配置 450L 大容积燃油箱，续航能力优越。

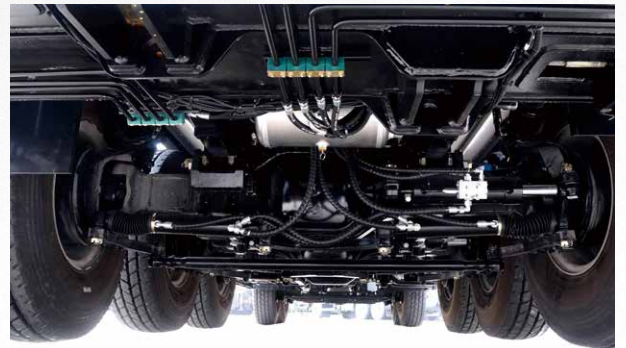

# Adjustable Counterweight Technology

## 配重变位技术介绍

The adjustable counterweight technology with CW lifting cylinder installed on the swing body, and the swing body can rotate 90° around the axis. Therefore, the CW lifting cylinder can move 550mm back and forth, and also the rotation of the swing body can be realized by a single person. The telescoping of the CW cylinder can be remotely controlled, which greatly saves time and improves work efficiency.

配重变位技术,配重提升油缸安装在摆动体上,摆动体可绕轴旋转 90 度,因此配重提升油缸可前后移动 550mm,摆动体的旋转可由单人实现,配重油缸的伸缩可由远程遥控,大幅节约了时间,提升了工作效率。

12 counterweight combinations: 1.3t, 11t, 13.3t, 17.3t, 21.3t, 23t, 27t, 31t, 31.3t, 41t, 42.3t, 52t.

It can achieve 24 combinations of effects with Adjustable Counterweight Technology.

12 种重量组合 1.3t、11t、13.3t、17.3t、21.3t、23t、27t、31t、31.3t、41t、42.3t、52t, 搭配配重变位技术,能够达到 24 种组合的效果。

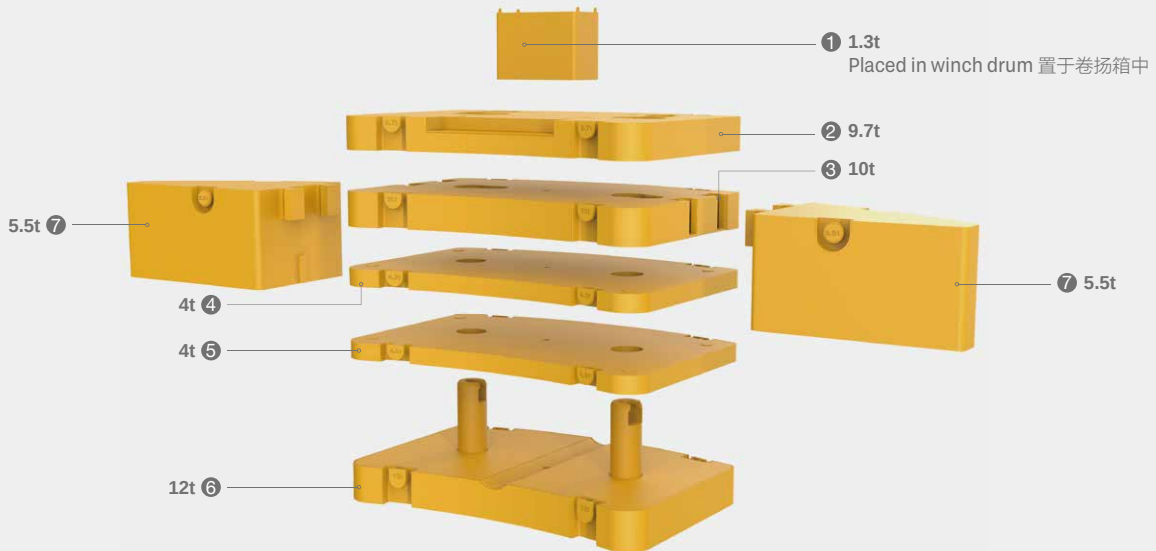

Total weight(t) 总重量	Combinations 组合	Total weight(t) 总重量	Combinations 组合
1.3	①	27	① + ② + ⑤ + ⑥
11	① + ②	31	① + ② + ④ + ⑤ + ⑥
13.3	① + ⑥	31.3	① + ③ + ④ + ⑤ + ⑥
17.3	① + ⑤ + ⑥	41	① + ② + ③ + ④ + ⑤ + ⑥
21.3	① + ④ + ⑤ + ⑥	42.3	① + ③ + ④ + ⑤ + ⑥ + ⑦
23	① + ② + ⑥	52	① + ② + ③ + ④ + ⑤ + ⑥ + ⑦



Three CW displacement schemes: front position, rear position 1, rear position 2.  
配重变位机构搭配配重可以分为前位、后位 1、后位 2。

1. Front position (Normal position), 41t CW  
1. 配重位于前位(正常情况),挂 41t 配重

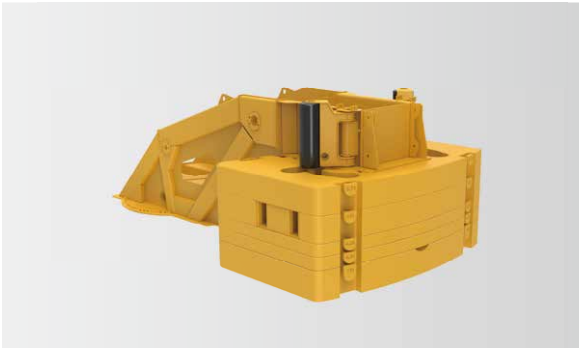

4.7m

**Total weight(t) 总重量**

1.3	1.3	11
11	11	13.3
13.3	13.3	17.3
17.3	17.3	21.3
21.3	21.3	23
23	23	27
27		31
31		31.3
31.3		41
41		42.3
42.3		52
52		

2. Rear position 1, 41t CW  
2. 配重部分后移,挂 41t 配重



5.25m

**Total weight(t) 总重量**

23	23	23
27		27
31		31
41		41
52		52

9.7t CW is placed in the front position, and 10t & 4t & 4t & 12t CW in the rear position, which increases the torque by 162kN.m. It is equivalent to adding an additional 4.5t CW in the front position situation.

9.7t 配重处于前位,10t、4t、4t、12t 配重处于后位,力矩增加了 162kN.m,等同于在配重前位状态下加一块 4.5t 配重。

3. Rear position 2, 41t CW  
3. 配重全后移,挂 41t 配重



5.25m

**Total weight(t) 总重量**

13.3	13.3	13.3
17.3	17.3	17.3
21.3	21.3	21.3
31.3		31.3
41		41
42.3		42.3
52		52

41t CW moves 550mm backward, and the torque increases by 221kN.m. It is equivalent to adding an additional 6t CW in the front position situation.

41t 配重整体后移 550mm,力矩增加了 221kN.m,等同于在配重前位状态下增加一块 6t 配重。

# Transport Dimensions

## 运输尺寸

Unit:mm

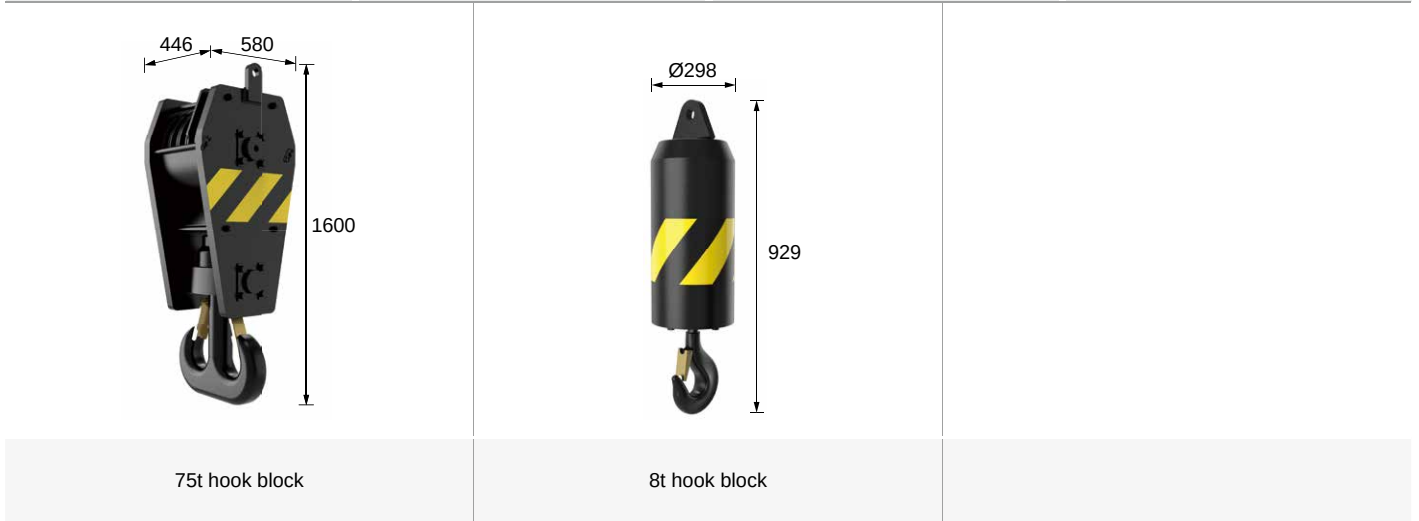
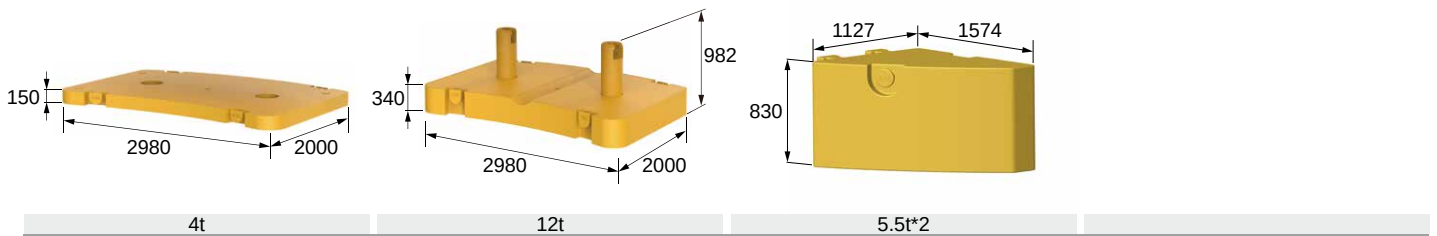
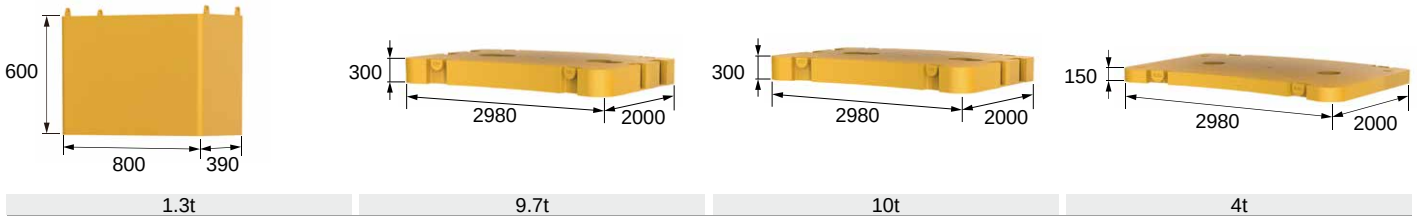

### Transport Solution 运输方案

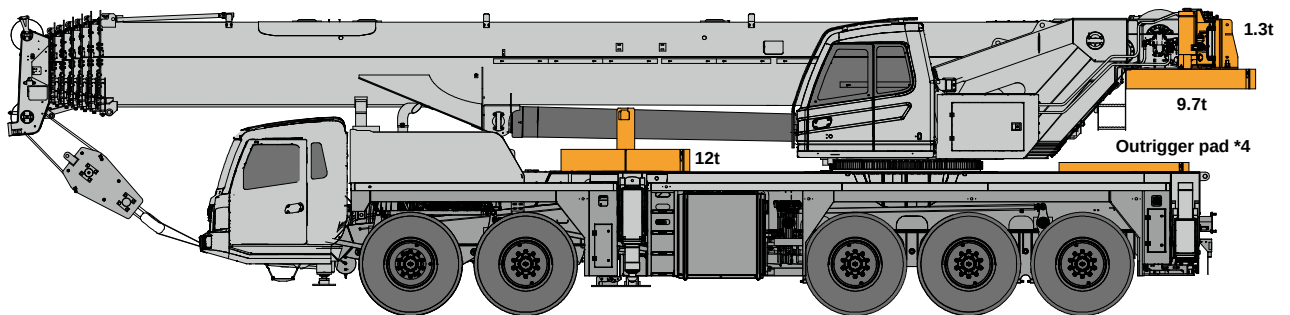

☰ 1.3t+9.7t+12t=23t, 4 outrigger pads are placed in rear section of frame

## Operator's cab 操纵室



20° tiltable operator's cab perfectly arranged with new interior decor, the new comfortable seat movable in a range of 150 mm and tiltable by 140°. Large size window and skylight increases visibility to secure clear view for load operation near or far away.

The new 7-vent air-conditioning system, switch button integrated in front dash, easy to operate.

The new membrane switch button is adopted and placed ergonomically. The operator can touch the buttons without bending forward. Mobile phone support, cup holder and rear storage shelf available.

Both sides of the chassis are equipped with a 300 mm widened foot step, and the superstructure is equipped with a maintenance staircase.

全新设计内装, 20°可仰, 选用全新舒适座椅, 前后移动距离 150mm, 可仰 140°, 操纵室前方视野清空, 远近距离吊载, 视野全线无遮挡。

全新立体 7 通道空调送风系统, 空调按钮前置, 操作方便, 体感舒适。

采用全新薄膜开关按键, 面板位置设计最优人机角度, 操作手无需前移操作; 设置手机支架, 水杯支架, 后置置物平台, 取用更便捷。

底盘两侧配置 300mm 加宽脚梯, 上车配置检修楼梯。

## Control system 操作系统



CAN BUS system: Controllers, displays, gauges, I/O modules, sensors, etc. are integrated in CAN Bus networking, fast-responsive.

Fault diagnosis system: Operating device with smart controller, body with BCM module, accurately locating the fault point for convenient maintenance.

7" HD color display and silica gel panel, to further improve man-machine interaction.

SANY load moment indicator system provides protection for overload, over release, and over winding.

智能总线网络系统: 整车控制器、显示器、显示仪表、I/O 模块、主要传感器等采用 CAN 总线组网, 高速信息传输。

智能故障诊断系统: 操作装置带智能控制器、车身带 BCM 控制模块, 拥有故障诊断系统, 能精准定位故障点, 方便检修。

高清 7" 彩色显示屏、硅胶面板操控, 进一步提升人机工程。

三一自主产权力矩限器系统, 具备超载、过放、过卷等全面的安全保护。

## Power Train 动力系统



### Engine

WEICHAH WP12.430N inline six-cylinder supercharged diesel engine with watercooler and inter cooler, conforming to Euro III emission standard.

Rated power: 316kW/1900rpm.

Max. torque: 2060Nm/ 1000~1400rpm.

Fuel reservoir capacity: 450L.

### Transmission

FAST manual transmission, 10 forward gears, 2 reversing gears, large speed ratio range, adaptable to slope climbing and high-speed traveling.

### Brake system

Composed of drum brake, air chamber and ABS system, the braking performance is more reliable and efficient. Standard service brake for all axles, parking brake for axle 2/3/4/5.

### Drive

Standard 10x6, with axle 3/4/5 driven.

### Steering system

Axle 1 and 2 are steered mechanically, axle 4 and 5 are steered electro hydraulically.

### 发动机

潍柴 WP12.430N 直列六缸、水冷却、增压中冷、柴油发动机，可满足欧三排放法规要求。

额定功率：316kW/1900rpm。

最大扭矩：2060Nm/ 1000~1400rpm。

燃油箱容积 450L。

### 变速箱

FAST 手动变速箱，变速箱有 10 个前进挡、2 个后退挡，速比范围大，既可满足低速场地爬坡行驶又可满足高速行驶。

### 制动系统

由鼓式制动器、制动气室、ABS 主要配件系统组成，制动性能更加可靠、高效。全桥标配行车制动，2、3、4、5 桥配驻车制动。

### 驱动系统

标配 10 × 6 驱动模式，3、4、5 桥为驱动桥。

### 转向系统

1、2 桥机械式转向机构，4、5 桥电液辅助转向。

## Electrical System 电气系统

### Precise load moment indicator system

SANY independently developed LMI, with an accuracy of 0~3%.

### Third wrap indicator

Standard electronic third wrap indicator can realize winch following.

### Cabling

Centralized electrical cabinet and heavy-duty connector applied for harness of superstructure, convenient for maintenance; IP rating up to IP67, ensuring high reliability.

### Winch monitoring system

Winch camera equipped for monitoring its working condition and identifying rope disorder in time.

### Anemometer

The anemometer is installed at the boom head, with real-time wind speed and allowable range displayed in the screen.

### 精准力限器系统

三一自主研发的力矩限制器系统，精度达 0~3%。

### 钢丝绳三圈保护器

标配电子三圈保护器，可实现卷扬随动。

### 电缆布线

上车电缆布线采用集中式分线盒及重载接插件，维护方便；防护等级 IP67，可靠性高。

### 卷扬监控系统

卷扬摄像头监视卷扬工作及时发现乱绳的情况。

### 风速仪

起重臂臂头设置风速仪，上车显示屏显示实时风速和安全风速。



Anti-two-block switch  
高度限位器



Third wrap indicator  
三圈保护器



Cable reel  
电缆卷筒



Anemometer  
风速仪

# MachineLink<sup>+</sup>

ROOTCLOUD T-AMS Pro device comes as standard to realize GPS trajectory, machine status, maintenance management, E-fence, alarm management, and operator management on computer or mobile MachineLink+ platform, by remote control of cranes. This telematics package greatly boosts efficiency of customer fleet management and helps provide better after-sales services.

标配树根物联终端 T-AMS Pro, 通过对起重机设备的远程控制, 在电脑或移动端 MachineLink+ 平台实现轨迹回放、设备状态、维保设备、电子围栏、报警管理、操作手管理等功能, 极大提高客户设备管理效率, 提升三一售后服务能力。

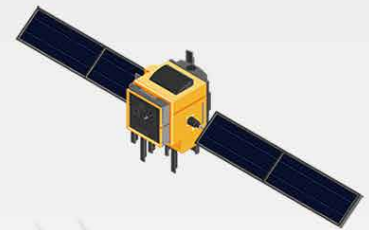
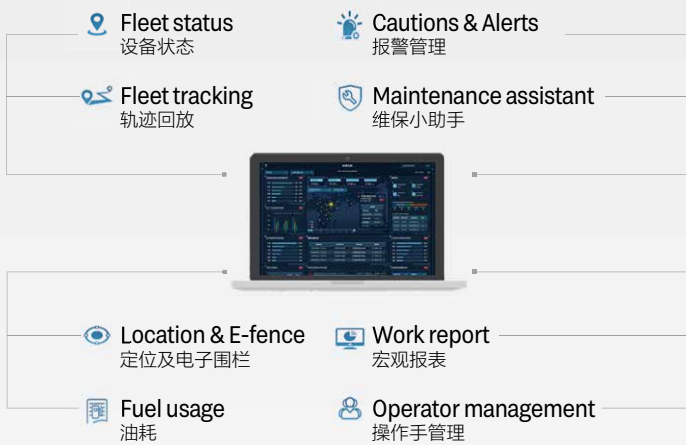

# Hydraulic System

## 液压系统

### Single cylinder pin

7 independent boom sections of variable length combinations, realizing higher lifting capacity at larger radius, time saving and labor saving.

### 单缸插销系统

含7节主臂,大臂间彼此独立,可实现更多臂段组合,为长臂段、大幅度状态下提供更大吊载能力,省时省力。



# Superstructure

## 上车

Open-type electronically controlled load-sensing system and closed-type slewing system, enabling simultaneous operation of four actions.  
Electro proportional compensated passive luffing-down system applied to control the luffing speed, making luffing more reliable and stable.

Closed-type slewing system, ensuring no pressure loss and no overflowing noise upon start/stop, and making the operation quieter and more energy-saving.

Electronically controlled load-sensing hydraulic system, electronic joystick and electronic throttle, ensuring easy operation and more accurate control and millisecond-level action response speed, with min. single-rope hoisting speed  $\leq 1.5\text{m/min}$ , and distribution difference in case of combined motions  $\leq 8\%$ .

通过开放式电控负载敏感系统和封闭式回转系统,可同时实现四动作联动。

电比例自重落幅系统控制落幅速度,更可靠更平稳。

采用封闭式回转系统,停启时无压力损失,无溢流噪声,更安静,更节能。

电控负载敏感液压系统,采用电手柄、电油门控制,轻松操作的同时,控制更精准;动作响应毫秒级速度;卷扬单绳最低速度  $\leq 1.5\text{m/min}$ ;复合动作分配误差  $\leq 8\%$ 。

### Double pump intelligent flow distribution system

Brand-name oil pump and motor, the min. winch single rope speed is less than  $1.5\text{m/min}$ , the min. stable slewing speed is less than  $0.1^\circ/\text{s}$ , easy to realize mm-level high precision operation.

New double pump intelligent flow distribution system, independent luffing, confluent telescoping, combined motion stability increased by more than 50%.

The electronically controlled system can save 15% energy and also improve the efficiency of heavy load operation by 30%.

### 双泵智能流量分配系统

国际知名品牌油泵、马达,卷扬单绳最低速度小于  $1.5\text{m/min}$ ,回转最低稳定小于  $0.1^\circ/\text{s}$ ,轻松实现毫米级吊装。

全新开发双泵智能流量分配系统,变幅独立,伸臂合流,复合动作平稳性提升 50% 以上。

电控系统使上车吊载综合节能 15%,重载作业效率提升 30%。

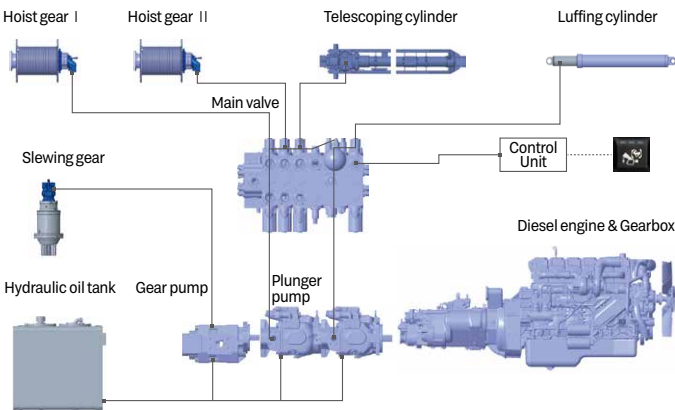

# Chassis

## 下车

### Dual circuit + emergency main steering system

Main steering system: Oil pump directly connected to the engine to supply oil independently to the steering gear, ensuring efficient and reliable steering.

Emergency steering system: Piston pump installed on the transmission, ensuring steering assistance throughout the traveling.

### Electro-hydraulic assisted steering system

A Hytek load-sensing piston pump installed to supply oil for assisted steering, which is directly connected to the engine and always in the standby mode, so that the assisted steering system can respond quickly once the assisted steering command is received.

### Outrigger telescoping system

Full-electric control of outrigger, realizing stepless telescoping.

### 双回路 + 应急主转向系统

主转向系统: 油泵与发动机直连, 独立对方向机供油, 主转向高效、可靠。

应急转向系统: 柱塞泵安装在变速箱上, 确保车辆行进过程中始终有转向助力。

### 电液辅助转向系统

辅助转向采用海特克负载敏感柱塞泵提供油源, 该油泵与发动机直连, 油泵始终处于转向待机模式, 一旦接到辅助转向指令, 辅助转向系统能够快速响应。

### 支腿伸缩系统

支腿伸缩采用全电控方式, 可实现支腿的无级伸缩。

# Overall Dimensions

整机尺寸

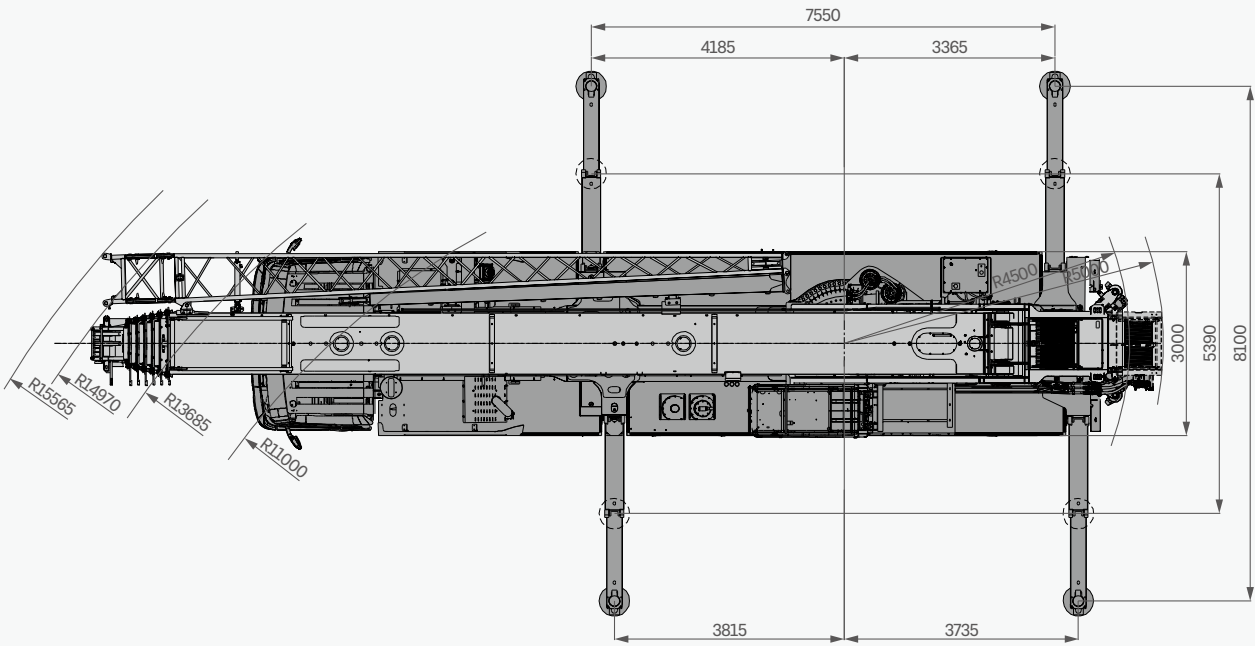
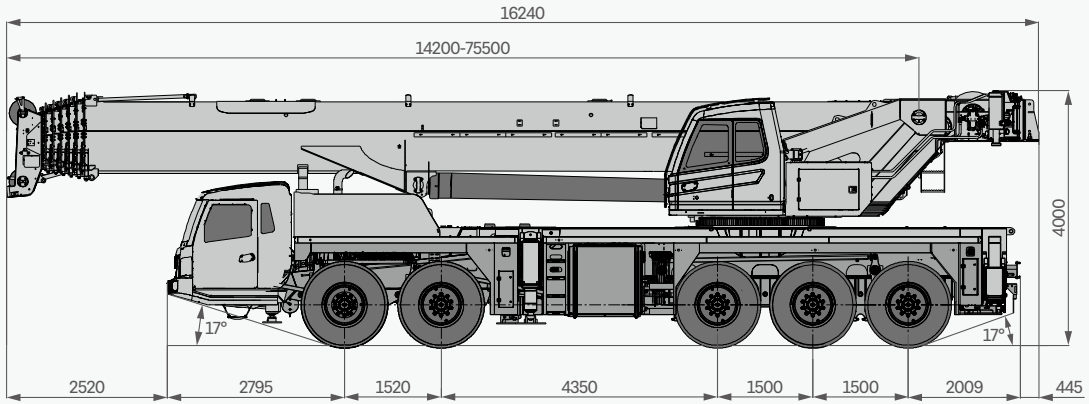



# Technical Specification

## 整机参数

CATEGORY 类型	ITEM 项目	UNIT 单位	VALUE 参数	
CAPACITY 额定起重量	Max. lifting capacity 最大起重量	t	160	
WEIGHT 重量参数	Gross weight 整机总质量	t	54.6	
POWER 发动机参数	Engine model 发动机型号 (排放标准)	-	WP12.430N(EURO III)	
	Max. engine power 发动机最大功率	kW/rpm	316/1900	
	Max. engine torque 发动机最大输出扭矩	N·m/rpm	2060/1000-1400	
DIMENSIONS 尺寸参数	Overall length 整机全长	mm	16240	
	Overall width 整机全宽	mm	3000	
	Overall height 整机全高	mm	3995	
TRAVEL 行驶参数	Max. travel speed 最高行驶速度	km/h	85	
	Steering radius 转弯半径	Min.steering radius 最小转弯半径	m	11
		Min.steering radius of boom tip 臂头最小转弯半径	m	15
	Wheel formula 车轮模式	-	10 × 6 × 8	
	Min.ground clearance 最小离地间隙	mm	310	
	Approach angle 接近角	°	17	
	Departure angle 离去角	°	17	
	Max.gradeability 最大爬坡度	-	45%	
	Fuel consumption per 100km 每 100 公里油耗	L	50	
	MAIN PERFORMANCE 主要性能参数	Working temperature range 使用温度区间	°C	-25~+45
Min.rated lifting radius 最小额定幅度		m	2.5	
Tail slewing radius 转台尾部回转半径		mm	4.5	
Boom sections (Qty.) 臂节数		-	7	
Boom shape 臂形状		-	Oval shape 卵圆型	
Max.lifting moment 最大起重力矩		Basic boom 基本臂	kN·m	5145
		Full-extension boom 全伸主臂	kN·m	2234
		Full-extension boom + jib 全伸主臂 + 副臂	kN·m	1019
		Full-extension boom + boom extension + jib 全伸主臂 + 延伸臂 + 副臂	kN·m	646
Boom length 臂长		Basic boom 基本臂	m	14.1
		Full-extension boom 全伸主臂	m	75.5
		Full-extension boom + jib 全伸主臂 + 副臂	m	93
		Full-extension boom + boom extension + jib 全伸主臂 + 延伸臂 + 副臂		102.5
Max.lifting height 最大起重高度		Basic boom 基本臂	m	14.6
		Full-extension boom 全伸主臂	m	76
		Full-extension boom + jib 全伸主臂 + 副臂	m	93
		Full-extension boom + boom extension + jib 全伸主臂 + 延伸臂 + 副臂	m	102.5
Outrigger span (Longitudinal × Transverse) 支腿跨距 (纵 × 横)	m	7.55 × 8.1		
Jib offset 副臂安装角度	°	0, 15, 30		
AIRCONDITIONER 空调	In operator's cab 上车空调	-	Heating & cooling 制冷、制热	
	In driver's cab 下车空调	-	Heating & cooling 制冷、制热	

# Technical Specification

## 整机参数



### Axle Load 轴荷

Axle 轴	1	2	3	4	5	Gross weight 总重量
Axle load 轴荷 /t	12	12	10.2	10.2	10.2	54.6
Remark 备注	Excluding jib, jib beacket, spare tire, hooks, auxiliary winch, outrigger floats, CW. 不带副臂、副臂托架、备胎、主副钩、副卷扬、支腿盘、配重					



### Hook 吊钩

Rated load 额载 /t	Number of sheaves 滑轮数量	Rope rate 倍率	Hook weight/kg 吊钩重量
● 8	0	1	170
● 75 (double eye 锚钩)	5	10	735
○ 50 (double eye 锚钩)	3	6	480
○ 100 (with additional device 需额外装置)	7	14	1030
● Standard 标配 ○ Optional 选配			



### Operations 主要动作参数

Item 项目	Max.single rope lifting speed (empty load) 单绳速度 (空载)	Rope diameter/length 钢丝绳直径 / 长度	Max. single line pull 最大单绳拉力
Main winch 主卷扬	135m/min	20mm/370m	7.5t
Auxiliary winch 副卷扬 (Optional 选配)	135m/min	20mm/215m	7.5t
Slewing speed 回转速度	1.5r/min		
Full luffing up/down time of boom 主臂起落幅时间	70s/100s		
Full extension/retraction time of boom 主臂伸缩时间	630s/650s		
Outrigger jack 垂直支腿	Retraction 收	60s	
	Extension 放	50s	
Outrigger beam 水平支腿	Retraction 收	20s	
	Extension 放	30s	

# Crane Introduction

## 整机介绍

Carrier 下车

### Driver's cab 驾驶室

- Self-developed full width cab in ergonomic design, featuring vibration and external noise isolation.
- Equipped with pneumatic suspension seats with headrest, safety belt, adjustable steering wheel, large rear-view mirror, defroster, Cooling & heating AC, stereo radio, and full set of instrument and controls, realizing safety and comfort.
- 自主开发全宽钢整体式钢结构驾驶室，采用人体工程学原理设计，减震性和封闭性优良。
- 配备气动悬置的驾驶座与副驾座、三点安全带、可调整式的转向盘、大视野后视镜、配有头枕的舒适驾驶椅、防雾扇、冷暖空调、立体收音机等，控制仪器和仪表齐全，更加舒适、安全、人性化。

### Carrier frame 车架

- Designed and manufactured by Sany, the torsion resistant box-type structure is welded by fine grain high-strength steel, featuring increased bearing capacity.
- 三一设计、制造，由细晶粒高强度钢板焊接而成的防扭转箱形结构，承载能力强。

### Engine 发动机

- Model: WEICHAI WP12.430N inline six-cylinder diesel engine with watercooler and inter cooler.
- Emission standard: Euro III.
- Fuel reservoir capacity: 450L.
- 型式：潍柴 WP12.430N、直列六缸、水冷却、增压中冷、柴油发动机。
- 排放标准：欧三。
- 燃料箱有效容积：450L。

### Transmission 变速箱

- Manual transmission, 10 forward gears, 2 reversing gears, large speed ratio range, adaptable to slope climbing and high-speed traveling.
- 手动变速箱，变速箱有 10 个前进挡、2 个后退挡，速比范围大，既可满足低速场地爬坡行驶又可满足高速行驶。

### Transmission shaft 传动轴

- Optimized layout, higher torque output via contrate gear connecting transmission shaft cardan.
- 优化的传动轴布置，传动轴传动平稳、可靠。最优化力传输，采用端面齿联结传动轴，传递扭矩大。

### Axle 车桥

- Axle 1、2、4、5 are steer axles, axles 3、4、5 are triplex tandem drive axles with built-in differential lock, realizing tougher ability to rough-terrain travelling. Two-stage reducer gear and more compact axle bags contribute to better accessibility. Press-welding axle housing technology, bearing capacity is stronger.
- 3、4、5 轴为三联贯通式驱动轴，动力更均衡，1、2、4、5 轴为转向轴，驱动轴内置轴间和轮间差速器锁，使车辆有更强的脱困能力；双级减速，桥包体积更小，使车辆有更好的通过性；冲焊桥壳工艺，承载能力更强。

### Suspension system 悬挂

- Front suspension is realized by independent leaf spring, middle and rear oscillation leaf spring. The leaf spring is verified by 100,000 cycling fatigue tests to ensure strength and ride comfort.
- 前轴采用独立式钢板弹簧，中后轴采用摆动支架式钢板弹簧平衡悬架系统；板簧经过超过 10 万次的疲劳试验，同时优化前后板簧的性能参数，保证强度的同时兼顾乘坐的舒适性。

### Steering 转向系统

- Axle 1 & 2 are mechanical steering, axle 4 & 5 are electro-hydraulic power steering.
- 1、2 桥机械式转向机构，4、5 桥电液辅助转向。

### Tires 轮胎

- Radial tires sized 385/95R25, commonly used for heavy-duty trucks.
- 子午线轮胎，全车使用 385/95R25，广泛适用于重型汽车，通用性强。

### Wheel formula 车轮模式

- 10 × 6 × 8.

### Outrigger 支腿

- H-type layout, four point support with high strength steel plate, easy to operate, outrigger beam hydraulically telescoping, jack telescoping protected by two-way holding valve.
- H 型支腿 4 点支撑，易操作、稳定性强；采用细晶粒高强度钢板材料，一、二级支腿全液压横向伸缩。垂直油缸采用双向液锁进行安全保护。

### Brake 制动系统

- The braking system includes service brake & parking brake & emergency brake & assisting brake.
- Service brake: air servo, dual circuit; whole axles adopts drum brake, delivering stronger braking performance.
- Parking brake: functioning at axles 2、3、4、5 by spring-loaded air chamber.
- Emergency brake: performed by accumulator releasing pressure.
- Assisting brake: engine exhaust brake, safety assured when driving down long slopes.
- 制动系统包括行车制动、驻车制动、应急制动和辅助制动。
- 行车制动采用双回路制动系统，所有车轮均采用空气伺服制动器，全桥采用鼓式制动，制动能力更强。
- 驻车制动是通过气室内弹簧作用在第二、三、四、五桥上。
- 应急制动阀由蓄能器储能断气制动兼做应急制动。
- 辅助制动为排气制动，保证在下长坡时的制动安全，保证行车的安全可靠。

### Electrical system 电气系统

- 2\*12V maintenance-free battery with a mechanical power switch, the overall power can be cut off manually. CAN instrument, data integration between superstructure and chassis.
- 2 × 12V 免维护蓄电池，配有机械式电源总开关，可手动切断整车电源；总线控制系统，可实现上下车信息交互。

# Crane Introduction

## 整机介绍

superstructure 上车

### Operator's cab 操纵室

- It adopts pressed and welded construction, equipped with safety glass, sun shade, outward opening door, joystick mounted on the control box in line with the principle of man-machine engineering. Corrosion-resistant FRP reinforced structure, fully covered softened interior, panoramic skylight, operator seat back tiltable and other use-friendly design, making it comfortable and easy to operate. Touch screen of adjustable angle realizes multi-screen & multi-angle monitoring to ensure working safety and the one-click operation. The main control console is combined with the operation display system for convenient man-machine interaction. Cab 20 ° tiltable, designed for easy observation of load at heights. Cooling and heating A/C available.
- 采用冲压成型的全焊接结构，装有安全玻璃，车窗装有遮阳帘，外开式车门，操纵杆安装在操纵箱上，符合人机工程原理；防腐玻璃钢强化复合结构、全覆盖软化内饰、全景式天窗、操作手座椅靠背可倾斜定位等人性化设计，操作舒适、轻松；触摸式显示屏，视角可调节、多画面、多角度监控保证作业安全，满足一键式操作；主控台与操作显示系统有机结合，人机交互方便快捷；操纵室可向上倾斜20°，满足高处的作业观察需要；配备冷暖空调。

### Boom & telescoping system 伸缩系统

- Single cylinder pin telescoping with electro hydraulic control, functioning automatic telescoping.
- Using multi-level pressure control, a number of telescopic balance valve cores, mechanic and hydraulic interlock of cylinder pins and boom pins, to ensure safe and reliable functioning.
- Oval shape seven-section boom with high strength steel plate.
- 采用单缸插销技术，通过电液控制系统实现缸销、臂销的插拔动作，配置自动伸缩功能。
- 采用多级压力控制，多个伸缩平衡阀芯，缸销臂销的机械液压的双重互锁机构，保证了伸缩系统安全可靠的工作。
- 7节臂，由高强度焊接结构钢制成，卵形截面。

### Hoist 起升系统

- Efficient and energy saving speed regulation is realized by double variables of pump and motor. Winch balance valve coupled with exclusive anti-slip tech contribute to smoother hoisting.
- Normally closed type winch brake and winch balance valve are set to prevent hook falling and stalling.
- Standard 8t & 75t hooks, non-rotation main wire rope with 20mm diameter and 370m length.
- 泵、马达双变量调速，高效节能。卷扬平衡阀与独特的防溜钩技术完美结合，重物起落平稳。
- 常闭式卷扬制动器，并设置卷扬平衡阀，可防止落钩失速。
- 标配 8t、75t 吊钩，长 370m 阻旋转钢丝绳（主），直径  $\phi$  20mm。

### Luffing system 变幅系统

- Passive luffing down with balance system, reducing energy cost yet raising stability. Adopting single cylinder and front hinge, it saves more effort in luffing and improves the situation of load of boom, and also uses electric proportional control balance valve. Luffing angle: 0°~80°.
- 自重落幅，更加节能。采用单根油缸，前铰支布置，变幅更省力且起重臂受力得到改善；采用电比例控制平衡阀。变幅角度：0°~80°。

### Hydraulics 液压系统

- Double pump intelligent flow distribution system to realize independent luffing and confluence telescoping, combined motion stability.
- Load sensing variable piston pump can control flow in high precision, reducing energy loss significantly.
- Electrically controlled valve functions flow compensation and load sensing control, securing stable control over single and combined motions.
- Winch adopts electric control variable motor, high efficiency at high speed, stable and low noise at low speed. The max. single rope lifting speed of main winch and auxiliary are 135m/min.
- 采用全新开发双泵智能流量系统，变幅独立，伸臂合流，复合动作操控性强。
- 采用国际知名品牌电比例负载敏感双联柱塞泵，高精度流量控制，能量损耗低。
- 电比例负载敏感多路阀，具备流量补偿、负载反馈控制功能，轻松实现单个动作和组合动作的稳定控制。
- 卷扬采用电控变量马达，高速效率高，低速稳定噪音小；主副卷扬单绳最大速度达 135m/min。

### Slewing 回转系统

- Integrated slewing buffer valve with free swing function. Smooth slewing start & control with excellent inching performance.
- 带集成回转缓冲阀，具有自由滑转功能，回转启动和控制平稳，微动性卓越。

# Crane Introduction

## 整机介绍



### Control system 控制系统

- Vehicle data display system: equipped with multiple sensors to give timely feedback of data information, achieving real-time monitoring of the vehicle working state.
- Man-machine interaction interface: more user-friendly interface with rich and clear information. Customers can set the vehicle controllability according to their personal operation habits and different operating conditions to fully meet the preferred needs of customers.
- 整车数据显示系统：配置丰富的传感器件，及时反馈数据信息，实现实时监控，确保随时掌控整车工作状态。
- 人机交互界面：人机交互界面设计人性化，信息丰富而清晰，客户可根据个人操作习惯和不同使用条件自行设置整车操控性，充分满足客户的个性化需求。



### Counterweight 配重

- Movable counterweight features combinations: 1.3t, 11t, 13.3t, 17.3t, 21.3t, 23t, 27t, 31t, 31.3t, 41t, 42.3t, 52t. CW assembly and disassembly controlled by remote device.
- 组合式可变平衡重。1.3t、11t、13.3t、17.3t、21.3t、23t、27t、31t、31.3t、41t、42.3t、52t 共 12 种组合方式，可后移 550mm，满足不同工况的需求，最大限度发挥结构件性能，可遥控拆卸及安装，微动性好。



### Safety equipment 安全装置

- Load moment indicator: A method of analytical mechanics is adopted and a moment limiter calculation system based on the hoisting mechanics model is established. Through online empty-load calibration, the rated hoisting accuracy can reach  $\pm 3\%$  to fully protect the hoisting operation.
- The hydraulic system is equipped with balance valve, relief valve, two-way holding valve, etc. to realize stability and reliability.
- Boom head and jib head are equipped with A2B switch to prevent the wire rope from over winding.
- The boom head is equipped with anemometer to detect whether the wind speed at heights exceeds the allowable range.
- The length & angle sensor and pressure sensor are equipped to display the operating status of the crane in real time, automatically cut off dangerous actions, and give a buzzer alarm.
- 采用分析力学方法，建立了基于吊重力学模型的力矩限制器计算系统，通过在线空载标定，吊重精度达到  $\pm 3\%$ 。
- 液压系统配置液压平衡阀、溢流阀、双向液压锁等元件，实现液压系统稳定可靠。
- 主、副臂端配置高度限位器，防止钢丝绳过卷。
- 臂端装有风速仪，检测高空风速是否超过可作业允许范围。
- 配置长度角度传感器、压力传感器，实时显示起重机作业状态，自动切断危险动作。



### Optional equipment at extra fees 选配

- 50t & 100t hook, 9.5m boom extension, outrigger pad, auxiliary winch assembly
- Customized painting
- Other equipment available upon request
- 50t、100t 吊钩，9.5m 延伸臂，支腿垫板，副卷扬装配总成
- 特殊涂装
- 其他配置视需求定

# Operating Range

## 起升高度曲线

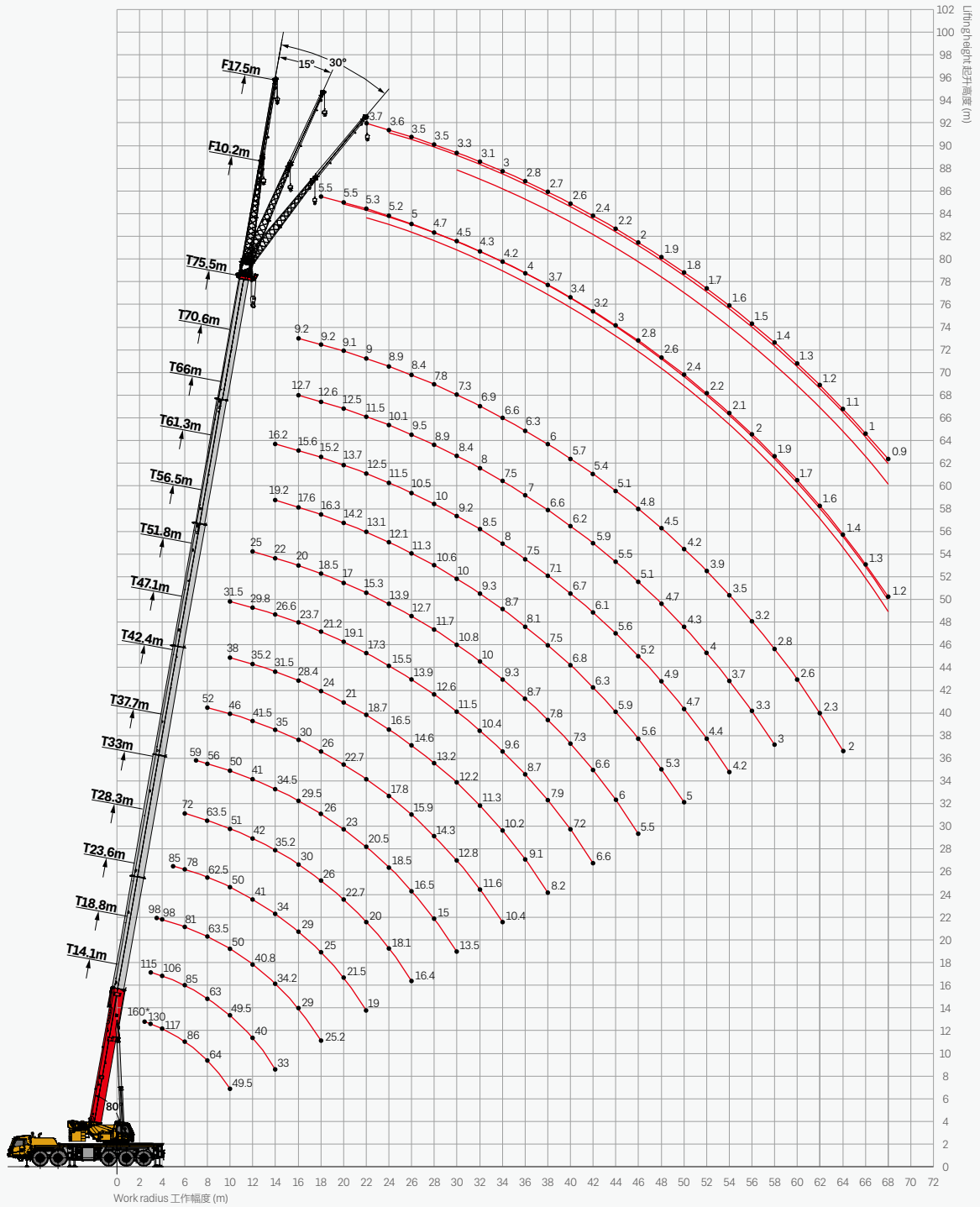

# Load Chart-Telescopic Boom

## 性能表 - 主臂

Unit: t

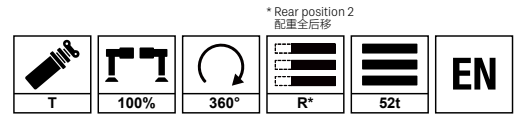

Radius (m) 幅度	14.1	18.8	23.5	28.2	32.9	37.6	42.3	47.0	51.7	56.4	61.1	65.8	70.5	75.5	Radius (m) 幅度
2.5	160*														2.5
3	130*	115*													3
3.5	126*	110*	98												3.5
4	117*	106*	98												4
4.5	109*	101	98												4.5
5	100	96	94	85*											5
5.5	93	90	87.5	81.5											5.5
6	86	85	81	78	72*										6
6.5	79.5	79	76	74	72*										6.5
7	75	73	71.5	70	72*	59									7
7.5	68.5	68	67	66	67.5	57.5									7.5
8	64	63	63.5	62.5	63.5	56	52								8
9	55.5	55.5	55.8	55	56	53.5	49	37							9
10	49.5	49.5	50	50	51	50	46	36	31.5						10
12		40	40.8	41	42	41	41.5	31.8	29.8	25					12
14		33	34.2	34	35.2	34.5	35	28.4	26.6	22	19.2	16.2			14
16			29	29	30	29.5	30	25.5	23.7	20	17.6	15.6	12.7	9.2	16
18			25.2	25	26	26	26	22	21.2	18.5	16.3	15.2	12.6	9.2	18
20				21.5	22.7	23	22.7	19.3	19.1	17	14.2	13.7	12.5	9.1	20
22				19	20	20.5	20	17.1	17.3	15.3	13.1	12.5	11.5	9	22
24					18.1	18.5	17.8	15.2	15.5	13.9	12.1	11.5	10.1	8.9	24
26					16.4	16.5	15.9	13.6	13.9	12.7	11.3	10.5	9.5	8.4	26
28						15	14.3	12.3	12.6	11.7	10.6	10	8.9	7.8	28
30						13.5	12.8	11.2	11.5	10.8	10	9.2	8.4	7.3	30
32							11.6	10.2	10.4	10	9.3	8.5	8	6.9	32
34							10.4	9.3	9.6	9.3	8.7	8	7.5	6.6	34
36								8.5	8.7	8.7	8.1	7.5	7	6.3	36
38								7.7	7.9	7.8	7.5	7.1	6.6	6	38
40									7.2	7.3	6.8	6.7	6.2	5.7	40
42									6.6	6.6	6.3	6.1	5.9	5.4	42
44										6	5.9	5.6	5.5	5.1	44
46										5.5	5.6	5.2	5.1	4.8	46
48											5.3	4.9	4.7	4.5	48
50											5	4.7	4.3	4.2	50
52												4.4	4	3.9	52
54												4.2	3.7	3.5	54
56													3.3	3.2	56
58													3	2.8	58
60														2.6	60
62														2.3	62
64														2	64
Rope rate 钢丝绳倍率	22	16	13	11	9	8	7	6	5	4	3	3	2	2	Rope rate 钢丝绳倍率

Remark: ratings with \* require higher rope rate and 100t-130t hook.  
注: 带 \* 的起重量需要提高倍率, 并使用 100-130 吨级吊钩。

# Load Chart-Telescopic Boom

## 性能表 - 主臂

Unit: t

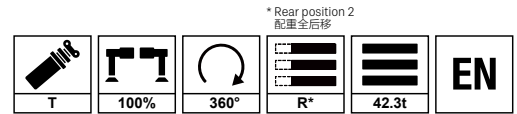

Radius (m) 幅度	14.1	18.8	23.5	28.2	32.9	37.6	42.3	47.0	51.7	56.4	61.1	65.8	70.5	75.5	Radius (m) 幅度
2.5	150*														2.5
3	130*	115*													3
3.5	124*	110*	98												3.5
4	114*	106*	98												4
4.5	105	101	98												4.5
5	95.5	95	91.5	85*											5
5.5	87.2	87	84.5	81.5											5.5
6	80	80	77.6	77.8	72*										6
6.5	74	74	72.5	72.3	72*										6.5
7	68.8	68.3	68.5	67.3	68	59									7
7.5	64	63.6	64.2	63	63.6	57.5									7.5
8	59.5	59.3	60.3	59	59.8	56	52								8
9	52.2	52	53.4	52.6	53.5	53	49	37							9
10	46.8	46.5	47.6	47.3	48	47.8	46	36	31.5						10
12		38	38.6	38.5	39.3	39.2	39.2	31.8	29.8	25					12
14		31.5	32.5	32	32.8	33.5	33	28.4	26.6	22	19.2	16.2			14
16			27.6	27	27.9	28.6	28.2	25.5	23.7	20	17.6	15.6	12.7	9.2	16
18			23.3	23.2	24.5	24.8	24.2	22	21.2	18.5	16.3	15.2	12.6	9.2	18
20				20	21.6	21.5	21	19.3	19	17	14.2	13.7	12.5	9.1	20
22				17.5	19.2	18.8	18.1	17.1	16.8	15.3	13.1	12.5	11.5	9	22
24					17	16.5	15.7	15.2	15.2	13.9	12.1	11.5	10.1	8.9	24
26					15	14.5	13.7	13.3	13.3	12.7	11.3	10.5	9.5	8.4	26
28						12.8	12	11.6	11.6	11.1	10.6	10	8.9	7.8	28
30						11.4	10.6	10.2	10.2	10.2	9.6	9.2	8.4	7.3	30
32							9.5	9.1	9.1	9	8.5	8.5	8	6.9	32
34							8.5	8	8.5	8.1	8	7.6	7.5	6.6	34
36								7.1	7.6	7.5	7.5	7	6.7	6.3	36
38								6.4	6.8	7.1	7.1	6.6	6	5.9	38
40									6.1	6.6	6.5	5.9	5.3	5.2	40
42									5.5	6.1	5.9	5.3	4.7	4.6	42
44										5.6	5.4	4.8	4.2	4.1	44
46										5.1	4.9	4.3	3.7	3.6	46
48											4.5	3.9	3.3	3.2	48
50											4.1	3.5	2.9	2.8	50
52												3.2	2.6	2.5	52
54												2.9	2.3	2.2	54
56													2	1.9	56
58													1.8	1.7	58
60														1.5	60
62															62
64															64
Rope rate 钢丝绳倍率	22	16	13	11	9	8	7	6	5	4	3	3	2	2	Rope rate 钢丝绳倍率

Remark: ratings with \* require higher rope rate and 100t-130t hook.  
注: 带 \* 的起重量需要提高倍率, 并使用 100-130 吨级吊钩。



# Load Chart-Telescopic Boom

## 性能表 - 主臂

Unit: t

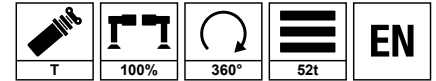

Radius (m) 幅度	14.1	18.8	23.5	28.2	32.9	37.6	42.3	47.0	51.7	56.4	61.1	65.8	70.5	75.5	Radius (m) 幅度
2.5	160*														2.5
3	130*	115*													3
3.5	124*	110*	98												3.5
4	114*	106*	98												4
4.5	106*	101	98												4.5
5	97	96	93	85*											5
5.5	88.5	88.5	86	81.5											5.5
6	81.5	81.5	79.5	78	72*										6
6.5	75.5	75.5	73.5	73.5	72*										6.5
7	70	70	70	69	69.5	59									7
7.5	65	65	66	64.5	65	57.5									7.5
8	60.5	60.5	62	60.5	61	56	52								8
9	53.2	53.2	54.5	53.7	54.5	53.5	49	37							9
10	47.5	47.2	48.5	48.5	49.2	48.7	46	36	31.5						10
12		38.5	39.5	39.5	40.2	39.8	40	31.8	29.8	25					12
14		32	33	33	33.7	33.8	33.8	28.4	26.6	22	19.2	16.2			14
16			28	28	28.7	29	29	25.5	23.7	20	17.6	15.6	12.7	9.2	16
18			24.5	24	24.7	25.5	25	22	21.2	18.5	16.3	15.2	12.6	9.2	18
20				21	22	22.3	22	19.3	19.1	17	14.2	13.7	12.5	9.1	20
22				18.3	19.6	19.8	19.3	17.1	17.3	15.3	13.1	12.5	11.5	9	22
24					17.7	17.6	17.1	15.2	15.5	13.9	12.1	11.5	10.1	8.9	24
26					16	15.8	15.2	13.6	13.9	12.7	11.3	10.5	9.5	8.4	26
28						14.2	13.5	12.3	12.6	11.7	10.6	10	8.9	7.8	28
30						12.9	12	11.2	11.5	10.8	10	9.2	8.4	7.3	30
32							10.7	10.2	10.3	9.6	9.3	8.5	8	6.9	32
34							9.7	9.3	9.2	8.9	8.6	8	7.5	6.6	34
36								8.4	8.3	8.3	7.6	7.5	7	6.3	36
38								7.6	7.4	7.5	7.1	7	6.6	6	38
40									6.7	6.8	6.7	6.3	6.2	5.7	40
42									6.1	6.2	6.3	5.8	5.9	5.4	42
44										5.7	5.9	5.5	5.3	5.1	44
46										5.3	5.6	5.2	4.8	4.6	46
48											5.3	4.8	4.3	4.1	48
50											5	4.5	3.9	3.7	50
52												4.2	3.5	3.3	52
54												3.8	3.2	3	54
56													2.9	2.7	56
58													2.6	2.4	58
60														2.2	60
62														2	62
64														1.7	64
Rope rate 钢丝绳倍率	22	16	13	11	9	8	7	6	5	4	3	3	2	2	Rope rate 钢丝绳倍率

Remark: ratings with \* require higher rope rate and 100t-130t hook.  
注: 带 \* 的起重量需要提高倍率, 并使用 100-130 吨级吊钩。

# Load Chart-Telescopic Boom

## 性能表 - 主臂

Unit: t

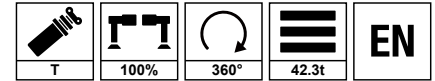

Radius (m) 幅度	14.1	18.8	23.5	28.2	32.9	37.6	42.3	47.0	51.7	56.4	61.1	65.8	70.5	75.5	Radius (m) 幅度
2.5	150*														2.5
3	130*	115*													3
3.5	122*	110*	98												3.5
4	113*	106*	98												4
4.5	102	100	97												4.5
5	92	92.5	89	85*											5
5.5	84	84.5	81	81.5											5.5
6	77.2	77.5	75.5	75.5	72*										6
6.5	71.5	71.5	71.5	70	70*										6.5
7	66.2	66	66.5	65	65.5	59									7
7.5	61.5	61.4	62	61	61.5	57.5									7.5
8	57.3	57.2	58	57	58	56	52								8
9	50.2	50.5	51.2	50.6	51.6	51	49	37							9
10	45	45.3	45.5	45.6	46.5	46	45.5	36	31.5						10
12		36.8	37	37	37.8	37.7	38	31.8	29.8	25					12
14		30.5	31.5	30.8	31.5	32.2	31.8	28.4	26.6	22	19.2	16.2			14
16			26.2	26	27	27.5	27	25.5	23.5	20	17.6	15.6	12.7	9.2	16
18			22	22.2	23.8	23.8	23.3	22	21	18.5	16.3	15.2	12.6	9.2	18
20				19.1	20.8	20.6	20	19.3	18.8	17	14.2	13.7	12.5	9.1	20
22				16.5	18.5	18	17.2	16.8	16.4	15.3	13.1	12.5	11.5	9	22
24					16.1	15.6	14.8	14.4	14.4	13.8	12.1	11.5	10.1	8.9	24
26					14.2	13.7	12.9	12.5	12.5	12	11.3	10.5	9.5	8.4	26
28						12.1	11.4	10.9	10.9	10.9	10.4	10	8.9	7.8	28
30						10.7	10	9.6	9.8	9.5	9	9.2	8.4	7.3	30
32							9.2	8.6	8.9	8.8	8.5	8.1	8	6.9	32
34							8.5	7.7	7.9	8.1	8	7.5	7.3	6.6	34
36								6.9	7	7.5	7.5	7	6.4	6.3	36
38								6.2	6.3	6.8	6.8	6.3	5.7	5.6	38
40									5.8	6.1	6.1	5.6	5	5	40
42									5.4	5.6	5.5	5	4.4	4.4	42
44										5.1	5	4.5	3.9	3.9	44
46										4.6	4.5	4	3.5	3.4	46
48											4.1	3.6	3.1	3	48
50											3.7	3.2	2.7	2.6	50
52												2.9	2.4	2.3	52
54												2.6	2.1	2	54
56													1.8	1.8	56
58													1.5	1.5	58
60															60
62															62
64															64
Rope rate 钢丝绳倍率	22	16	13	11	9	8	7	6	5	4	3	3	2	2	Rope rate 钢丝绳倍率

Remark: ratings with \* require higher rope rate and 100t-130t hook.  
注：带 \* 的起重量需要提高倍率，并使用 100-130 吨级吊钩。

# Load Chart-Telescopic Boom

## 性能表 - 主臂

Unit: t

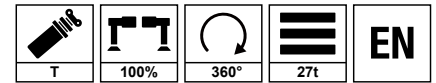

Radius (m) 幅度	14.1	18.8	23.5	28.2	32.9	37.6	42.3	47.0	51.7	56.4	61.1	65.8	70.5	75.5	Radius (m) 幅度
2.5	145*														2.5
3	130*	115*													3
3.5	120*	110*	98												3.5
4	107*	106*	98												4
4.5	95.5	95	93.5												4.5
5	86	85.8	84.5	84*											5
5.5	78	78	78	77.5											5.5
6	71.3	72	72	72	71*										6
6.5	65.5	66.3	66.2	66.5	66.5										6.5
7	60.5	61.3	61.3	61.5	62	59									7
7.5	56	57.1	57	57	57.8	57									7.5
8	52.2	53.2	53.2	53.3	54	53.5	52								8
9	45.5	46.7	46.8	46.8	47.5	47.8	47.5	37							9
10	40.8	41.3	41.5	41.5	42.2	42.8	42.3	36	31.5						10
12		33	33.2	33	34.2	34.8	34.2	31.8	29.8	25					12
14		26.8	26.8	26.7	28.6	28.5	27.6	26.7	26.4	22	19.2	16.2			14
16			21.4	21.1	23.3	22.8	21.9	21.5	21.6	20	17.6	15.6	12.7	9.2	16
18			17.4	17	19.2	18.6	17.8	17.4	17.5	17.5	16.3	15.2	12.6	9.2	18
20				15.5	16	15.5	15.2	14.7	14.3	14.5	14	13.7	12.5	9.1	20
22				13.8	13.6	13.1	13.6	12.2	12.3	12.5	12.2	11.9	11.5	9	22
24					11.6	11.2	11.6	10.3	10.4	11	10.8	10.6	10.1	8.9	24
26					10	10	10	8.7	9.5	9.4	9.4	9	8.8	8.4	26
28						9.1	8.7	7.9	8.9	8.1	8	7.7	7.5	7.4	28
30						8.2	7.6	7.3	7.8	7.3	6.9	6.6	6.4	6.3	30
32							6.7	6.8	6.9	6.6	6	5.7	5.5	5.4	32
34							5.9	6.3	6.1	5.8	5.2	4.9	4.7	4.6	34
36								5.9	5.4	5.2	4.5	4.2	4	3.9	36
38								5.3	4.8	4.6	3.9	3.6	3.4	3.3	38
40									4.3	4.1	3.4	3.1	2.9	2.8	40
42									3.8	3.6	3	2.7	2.4	2.4	42
44										3.2	2.6	2.3	2	2	44
46										2.8	2.2	1.9	1.6	1.6	46
48											1.9	1.6			48
50											1.6				50
52															52
54															54
56															56
58															58
60															60
62															62
64															64
Rope rate 钢丝绳倍率	22	16	13	11	9	8	7	6	5	4	3	3	2	2	Rope rate 钢丝绳倍率

Remark: ratings with \* require higher rope rate and 100t-130t hook.  
注: 带 \* 的起重量需要提高倍率, 并使用 100-130 吨级吊钩。

# Load Chart-Telescopic Boom

## 性能表 - 主臂

Unit: t

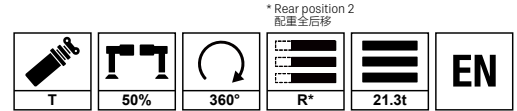

Radius (m) 幅度	14.1	18.8	23.5	28.2	32.9	37.6	42.3	47.0	51.7	56.4	61.1	65.8	70.5	75.5	Radius (m) 幅度
2.5	130*														2.5
3	117*	115*													3
3.5	105	105	98												3.5
4	97	97	97.5												4
4.5	90	90	89.5												4.5
5	81.5	82	82	81.5*											5
5.5	73.5	74.5	75	74.5											5.5
6	66	67.5	68	68	68										6
6.5	56.5	58.3	58.6	58.1	59.4										6.5
7	49	50.5	50.8	50.3	53	52.9									7
7.5	43	44.4	44.6	44.1	47.2	46.7									7.5
8	38.2	39.4	39.6	39.2	42.1	41.6	41.5								8
9	30.7	31.8	32	32.5	34.3	33.8	33.6	33.5							9
10	25.3	26.3	26.5	28.8	28.6	29	28.2	27.8	28						10
12		19.6	20.9	21.1	20.9	21.1	21.4	20.3	20.2	20.4					12
14		14.8	16	16.2	16	17	16.4	15.3	15.7	16.3	16.3	15.3			14
16			12.6	12.8	13.4	13.6	12.9	13.2	13.4	13.2	12.9	12.7	12.3	9.2	16
18			10.1	10.3	10.9	11	10.4	11.1	10.8	10.6	10.3	10.1	9.8	9.2	18
20				8.4	9	9	8.4	9.1	8.8	8.7	8.3	8.2	7.8	7.7	20
22				7.3	7.5	7.4	6.9	7.5	7.3	7.2	6.8	6.6	6.3	6.2	22
24					6.3	6.2	5.7	6.3	6.1	6	5.6	5.4	5.1	5	24
26					5.4	5.2	4.7	5.3	5.1	5	4.6	4.4	4.1	4	26
28						4.4	3.9	4.5	4.2	4.2	3.8	3.6	3.2	3.2	28
30						3.7	3.2	3.8	3.6	3.5	3.1	2.8	2.4	2.4	30
32							2.6	3.2	3	2.9	2.5	2.2	1.8	1.8	32
34							2.1	2.7	2.4	2.4	2	1.7			34
36								2.3	1.9	1.9	1.5				36
38								1.9	1.5	1.5					38
40															40
42															42
44															44
46															46
48															48
50															50
52															52
54															54
56															56
58															58
60															60
62															62
64															64
Rope rate 钢丝绳倍率	22	16	13	11	9	8	7	6	5	4	3	3	2	2	Rope rate 钢丝绳倍率

Remark: ratings with \* require higher rope rate and 100t-130t hook.  
注：带 \* 的起重量需要提高倍率，并使用 100-130 吨级吊钩。

# Load Chart-Telescopic Boom

## 性能表 - 主臂

Unit: t

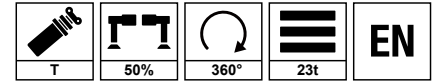

Radius (m) 幅度	14.1	18.8	23.5	28.2	32.9	37.6	42.3	47.0	51.7	56.4	61.1	65.8	70.5	75.5	Radius (m) 幅度
2.5	130*														2.5
3	117*	115*													3
3.5	105	105	98												3.5
4	97	97	96.5												4
4.5	89.5	89	89												4.5
5	81	81.5	82	81*											5
5.5	73	74	74	74											5.5
6	66	67	67.5	67.5	68										6
6.5	56.5	58.3	58.6	58.1	59.4										6.5
7	49	50.5	50.8	50.3	53	52.9									7
7.5	43	44.4	44.6	44.1	47.2	46.7									7.5
8	38.2	39.4	39.6	39.2	42.1	41.6	41.5								8
9	30.7	31.8	32	32.5	34.3	33.8	33.6	33.5							9
10	25.3	26.3	26.5	28.8	28.6	29	28.2	27.8	28						10
12		19.6	20.9	21.1	20.9	21.1	21.4	20.3	20.2	20.4					12
14		14.8	16	16.2	16	17	16.4	15.3	15.7	16.3	16.3	15.3			14
16			12.6	12.8	13.4	13.6	12.9	13.2	13.4	13.2	12.9	12.7	12.3	9.2	16
18			10.1	10.3	10.9	11	10.4	11.1	10.8	10.6	10.3	10.1	9.8	9.2	18
20				8.4	9	9	8.4	9.1	8.8	8.7	8.3	8.2	7.8	7.7	20
22				7.3	7.5	7.4	6.9	7.5	7.3	7.2	6.8	6.6	6.3	6.2	22
24					6.3	6.2	5.7	6.3	6.1	6	5.6	5.4	5.1	5	24
26					5.4	5.2	4.7	5.3	5.1	5	4.6	4.4	4.1	4	26
28						4.4	3.9	4.5	4.2	4.2	3.8	3.6	3.2	3.2	28
30						3.7	3.2	3.8	3.6	3.5	3.1	2.8	2.4	2.4	30
32							2.6	3.2	3	2.9	2.5	2.2	1.8	1.8	32
34							2.1	2.7	2.4	2.4	2	1.7			34
36								2.3	1.9	1.9	1.5				36
38								1.9	1.5	1.5					38
40															40
42															42
44															44
46															46
48															48
50															50
52															52
54															54
56															56
58															58
60															60
62															62
64															64
Rope rate 钢丝绳倍率	22	16	13	11	9	8	7	6	5	4	3	3	2	2	Rope rate 钢丝绳倍率

Remark: ratings with \* require higher rope rate and 100t-130t hook.  
注: 带 \* 的起重量需要提高倍率, 并使用 100-130 吨级吊钩。

# Operating Range

## 起升高度曲线

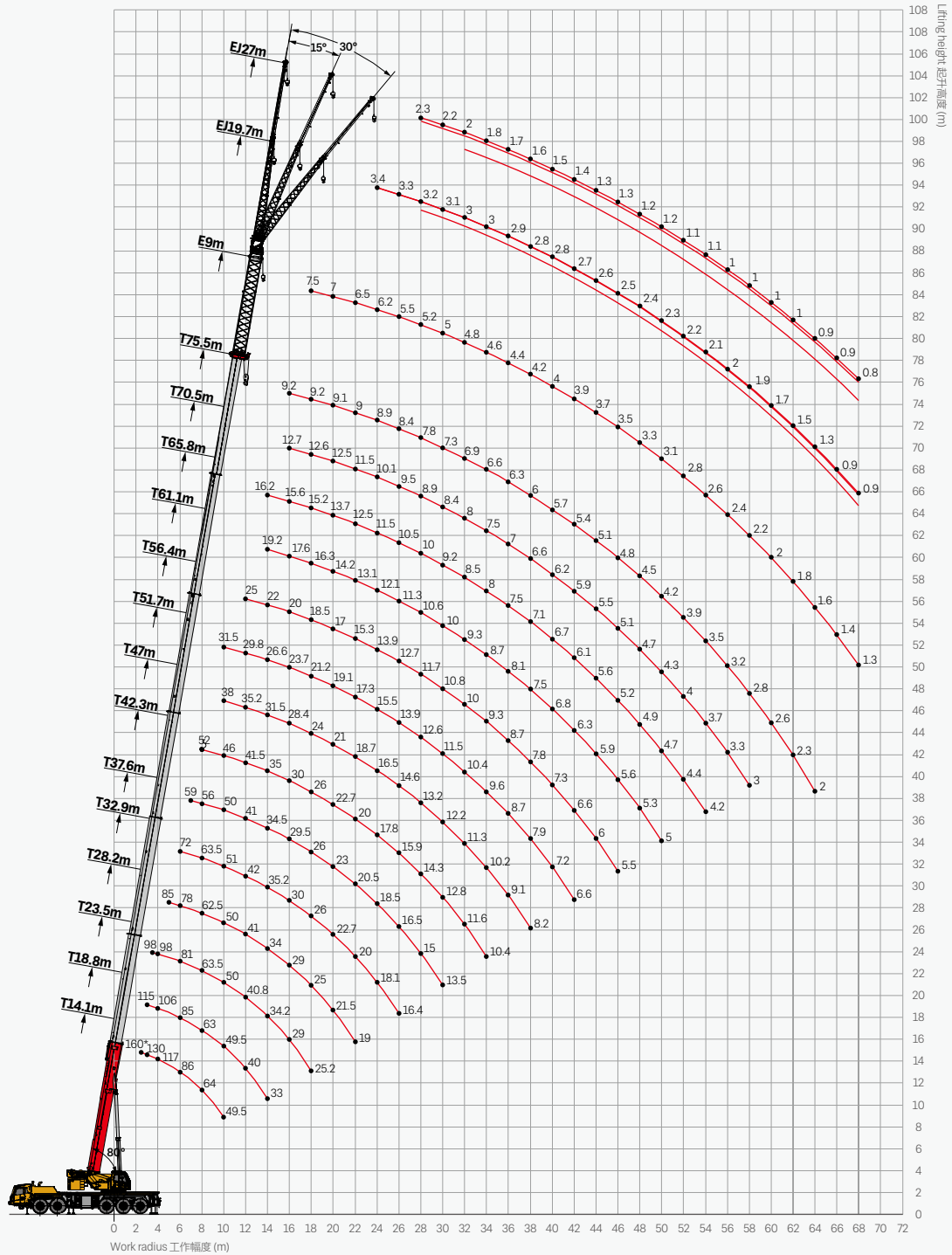

# Load Chart - Fixed Jib

## 性能表 - 副臂

Unit: t

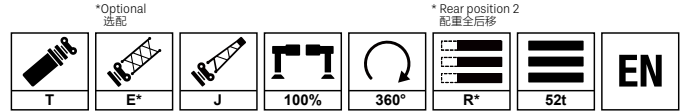

Boom angle 主臂仰角 (°)	75.5m+10.2m			75.5m+17.5m			75.5m+9m	75.5m+19.7m			75.5m+27m			Boom angle 主臂仰角 (°)
	0°	15°	30°	0°	15°	30°	0°	0°	15°	30°	0°	15°	30°	
18	5.5						7.5							18
20	5.5	4					7							20
22	5.3	4	3.3	3.7			6.5							22
24	5.2	4	3.3	3.6			6.2	3.4						24
26	5	4	3.3	3.5	2.4		5.5	3.3	2.7					26
28	4.7	3.9	3.2	3.5	2.3		5.2	3.2	2.6	2.1	2.3			28
30	4.5	3.9	3.2	3.3	2.3	1.6	5	3.1	2.6	2	2.2	1.5		30
32	4.3	3.8	3.2	3.1	2.2	1.6	4.8	3	2.5	2	2	1.5	1.3	32
34	4.2	3.7	3.1	3	2.2	1.6	4.6	3	2.4	1.9	1.8	1.4	1.2	34
36	4	3.6	3	2.8	2.1	1.6	4.4	2.9	2.3	1.9	1.7	1.3	1.2	36
38	3.7	3.5	2.9	2.7	2	1.5	4.2	2.8	2.2	1.8	1.6	1.2	1.2	38
40	3.4	3.2	2.8	2.6	1.9	1.5	4	2.8	2	1.8	1.5	1.2	1.2	40
42	3.2	3	2.7	2.4	1.8	1.5	3.9	2.7	1.9	1.7	1.4	1.2	1.1	42
44	3	2.8	2.6	2.2	1.8	1.4	3.7	2.6	1.8	1.7	1.3	1.1	1.1	44
46	2.8	2.6	2.4	2	1.8	1.4	3.5	2.5	1.7	1.6	1.3	1.1	1.1	46
48	2.6	2.4	2.2	1.9	1.7	1.3	3.3	2.4	1.6	1.6	1.2	1.1	1.1	48
50	2.4	2.2	2.1	1.8	1.6	1.3	3.1	2.3	1.5	1.6	1.2	1	1	50
52	2.2	2.1	2	1.7	1.5	1.3	2.8	2.2	1.4	1.5	1.1	1	1	52
54	2.1	2	1.9	1.6	1.4	1.3	2.6	2.1	1.3	1.4	1.1	1	1	54
56	2	1.9	1.8	1.5	1.3	1.3	2.4	2	1.2	1.3	1	1	1	56
58	1.9	1.8	1.7	1.4	1.3	1.2	2.2	1.9	1.1	1.2	1	1	1	58
60	1.7	1.6	1.5	1.3	1.2	1.2	2	1.7	1	1.1	1	0.9	0.9	60
62	1.6	1.5	1.4	1.2	1.1	1.2	1.8	1.5	1	1	1	0.9	0.9	62
64	1.4	1.4	1.3	1.1	1	1.2	1.6	1.3	0.9	0.9	0.9	0.9	0.9	64
66	1.3	1.3	1.2	1	0.9	1.1	1.4	0.9	0.9	0.9	0.9	0.9	0.8	66
68	1.2	1.2	1.1	0.9	0.8	1.1	1.3	0.9	0.8	0.8	0.8	0.8	0.8	68
Rope rate 钢丝绳倍率	1													Rope rate 钢丝绳倍率

# Load Chart - Fixed Jib

## 性能表 - 副臂

Unit: t

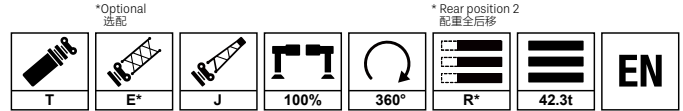

Boom angle 主臂仰角 (°)	75.5m+10.2m			75.5m+17.5m			75.5m+9m	75.5m+19.7m			75.5m+27m			Boom angle 主臂仰角 (°)
	0°	15°	30°	0°	15°	30°	0°	0°	15°	30°	0°	15°	30°	
18	5.5						7.5							18
20	5.5	4					7							20
22	5.3	4	3.3	3.7			6.5							22
24	5.2	4	3.3	3.6			6.2	3.4						24
26	5	4	3.3	3.5	2.4		5.5	3.3	2.7					26
28	4.7	3.9	3.2	3.5	2.3		5.2	3.2	2.6	2.1	2.3			28
30	4.5	3.9	3.2	3.3	2.3	1.6	5	3.1	2.6	2	2.2	1.5		30
32	4.3	3.8	3.2	3.1	2.2	1.6	4.8	3	2.5	2	2	1.5	1.3	32
34	4.2	3.7	3.1	3	2.2	1.6	4.6	3	2.4	1.9	1.8	1.4	1.2	34
36	4	3.6	3	2.8	2.1	1.6	4.4	2.9	2.3	1.9	1.7	1.3	1.2	36
38	3.7	3.5	2.9	2.7	2	1.5	4.2	2.8	2.2	1.8	1.6	1.2	1.2	38
40	3.4	3.2	2.8	2.6	1.9	1.5	4	2.8	2	1.8	1.5	1.2	1.2	40
42	3.2	3	2.7	2.4	1.8	1.5	3.6	2.7	1.9	1.7	1.4	1.2	1.1	42
44	3	2.8	2.6	2.2	1.8	1.4	3.3	2.6	1.8	1.7	1.3	1.1	1.1	44
46	2.8	2.6	2.4	2	1.8	1.4	3	2.5	1.7	1.6	1.3	1.1	1.1	46
48	2.6	2.4	2.2	1.9	1.7	1.3	2.7	2.4	1.6	1.6	1.2	1.1	1.1	48
50	2.4	2.2	2.1	1.8	1.6	1.3	2.4	2.3	1.5	1.6	1.2	1	1	50
52	2.1	2.1	2	1.7	1.5	1.3	2.2	2.2	1.4	1.5	1.1	1	1	52
54	1.9	1.9	1.9	1.6	1.4	1.3	1.9	2	1.3	1.4	1.1	1	1	54
56	1.7	1.7	1.7	1.5	1.3	1.3	1.7	1.8	1.2	1.3	1	1	1	56
58	1.5	1.5	1.6	1.4	1.3	1.2	1.5	1.6	1.1	1.2	1	1	1	58
60	1.4	1.4	1.4	1.3	1.2	1.2	1.4	1.4	1	1.1	1	0.9	0.9	60
62	1.2	1.2	1.2	1.2	1.1	1.2	1.2	1.3	1	1	1	0.9	0.9	62
64	1.1	1.1	1.1	1.1	1	1.2	1	1.1	0.9	0.9	0.9	0.9	0.9	64
66	0.9	0.9	0.9	1	0.9	1.1	0.9	0.9	0.9	0.9	0.9	0.9	0.8	66
68				0.9	0.8	1.1		0.8	0.8	0.8	0.8	0.8	0.8	68
Rope rate 钢丝绳倍率	1													Rope rate 钢丝绳倍率



# Load Chart - Fixed Jib

## 性能表 - 副臂

Unit: t

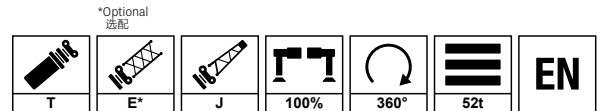

Boom angle 主臂仰角 (°)	75.5m+10.2m			75.5m+17.5m			75.5m+9m	75.5m+19.7m			75.5m+27m			Boom angle 主臂仰角 (°)
	0°	15°	30°	0°	15°	30°	0°	0°	15°	30°	0°	15°	30°	
18	5.5						7.5							18
20	5.5	4					7							20
22	5.3	4	3.3	3.7			6.5							22
24	5.2	4	3.3	3.6			6.2	3.4						24
26	5	4	3.3	3.5	2.4		5.5	3.3	2.7					26
28	4.7	3.9	3.2	3.5	2.3		5.2	3.2	2.6	2.1	2.3			28
30	4.5	3.9	3.2	3.3	2.3	1.6	5	3.1	2.6	2	2.2	1.5		30
32	4.3	3.8	3.2	3.1	2.2	1.6	4.8	3	2.5	2	2	1.5	1.3	32
34	4.2	3.7	3.1	3	2.2	1.6	4.6	3	2.4	1.9	1.8	1.4	1.2	34
36	4	3.6	3	2.8	2.1	1.6	4.4	2.9	2.3	1.9	1.7	1.3	1.2	36
38	3.7	3.5	2.9	2.7	2	1.5	4.2	2.8	2.2	1.8	1.6	1.2	1.2	38
40	3.4	3.2	2.8	2.6	1.9	1.5	4	2.8	2	1.8	1.5	1.2	1.2	40
42	3.2	3	2.7	2.4	1.8	1.5	3.9	2.7	1.9	1.7	1.4	1.2	1.1	42
44	3	2.8	2.6	2.2	1.8	1.4	3.7	2.6	1.8	1.7	1.3	1.1	1.1	44
46	2.8	2.6	2.4	2	1.8	1.4	3.5	2.5	1.7	1.6	1.3	1.1	1.1	46
48	2.6	2.4	2.2	1.9	1.7	1.3	3.2	2.4	1.6	1.6	1.2	1.1	1.1	48
50	2.4	2.2	2.1	1.8	1.6	1.3	2.9	2.3	1.5	1.6	1.2	1	1	50
52	2.2	2.1	2	1.7	1.5	1.3	2.6	2.2	1.4	1.5	1.1	1	1	52
54	2.1	2	1.9	1.6	1.4	1.3	2.4	2.1	1.3	1.4	1.1	1	1	54
56	2	1.9	1.8	1.5	1.3	1.3	2.2	2	1.2	1.3	1	1	1	56
58	1.9	1.8	1.7	1.4	1.3	1.2	2	1.9	1.1	1.2	1	1	1	58
60	1.7	1.6	1.5	1.3	1.2	1.2	1.8	1.7	1	1.1	1	0.9	0.9	60
62	1.6	1.5	1.4	1.2	1.1	1.2	1.6	1.5	1	1	1	0.9	0.9	62
64	1.4	1.4	1.3	1.1	1	1.2	1.4	1.3	0.9	0.9	0.9	0.9	0.9	64
66	1.3	1.3	1.2	1	0.9	1.1	1.3	0.9	0.9	0.9	0.9	0.9	0.8	66
68	1.2	1.2	1.1	0.9	0.8	1.1	1.1	0.9	0.8	0.8	0.8	0.8	0.8	68
Rope rate 钢丝绳倍率	1													Rope rate 钢丝绳倍率

# Load Chart - Fixed Jib

## 性能表 - 副臂

Unit: t

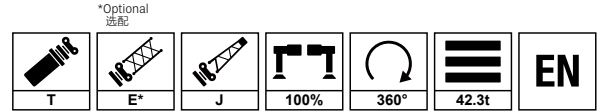

Boom angle 主臂仰角 (°)	75.5m+10.2m			75.5m+17.5m			75.5m+9m	75.5m+19.7m			75.5m+27m			Boom angle 主臂仰角 (°)
	0°	15°	30°	0°	15°	30°	0°	0°	15°	30°	0°	15°	30°	
18	5.5						7.5							18
20	5.5	4					7							20
22	5.3	4	3.3	3.7			6.5							22
24	5.2	4	3.3	3.6			6.2	3.4						24
26	5	4	3.3	3.5	2.4		5.5	3.3	2.7					26
28	4.7	3.9	3.2	3.5	2.3		5.2	3.2	2.6	2.1	2.3			28
30	4.5	3.9	3.2	3.3	2.3	1.6	5	3.1	2.6	2	2.2	1.5		30
32	4.3	3.8	3.2	3.1	2.2	1.6	4.8	3	2.5	2	2	1.5	1.3	32
34	4.2	3.7	3.1	3	2.2	1.6	4.6	3	2.4	1.9	1.8	1.4	1.2	34
36	4	3.6	3	2.8	2.1	1.6	4.4	2.9	2.3	1.9	1.7	1.3	1.2	36
38	3.7	3.5	2.9	2.7	2	1.5	4.1	2.8	2.2	1.8	1.6	1.2	1.2	38
40	3.4	3.2	2.8	2.6	1.9	1.5	3.7	2.8	2	1.8	1.5	1.2	1.2	40
42	3.2	3	2.7	2.4	1.8	1.5	3.4	2.7	1.9	1.7	1.4	1.2	1.1	42
44	3	2.8	2.6	2.2	1.8	1.4	3	2.6	1.8	1.7	1.3	1.1	1.1	44
46	2.7	2.6	2.4	2	1.8	1.4	2.7	2.5	1.7	1.6	1.3	1.1	1.1	46
48	2.4	2.4	2.2	1.9	1.7	1.3	2.4	2.4	1.6	1.6	1.2	1.1	1.1	48
50	2.1	2.2	2.1	1.8	1.6	1.3	2.2	2.3	1.5	1.6	1.2	1	1	50
52	1.9	2	2	1.7	1.5	1.3	2	2.1	1.4	1.5	1.1	1	1	52
54	1.7	1.8	1.8	1.6	1.4	1.3	1.8	1.9	1.3	1.4	1.1	1	1	54
56	1.5	1.6	1.6	1.5	1.3	1.3	1.6	1.7	1.2	1.3	1	1	1	56
58	1.3	1.4	1.4	1.4	1.3	1.2	1.4	1.5	1.1	1.2	1	1	1	58
60	1.2	1.2	1.2	1.3	1.2	1.2	1.2	1.3	1	1.1	1	0.9	0.9	60
62	1	1.1	1.1	1.2	1.1	1.2	1	1.1	1	1	1	0.9	0.9	62
64	0.9	0.9	0.9	1.1	1	1.2	0.9	1	0.9	0.9	0.9	0.9	0.9	64
66				1	0.9	1.1			0.8	0.8	0.9	0.9	0.8	66
68				0.9	0.8	1					0.8	0.8	0.8	68
Rope rate 钢丝绳倍率	1													Rope rate 钢丝绳倍率

# Load Chart - Fixed Jib

## 性能表 - 副臂

Unit: t

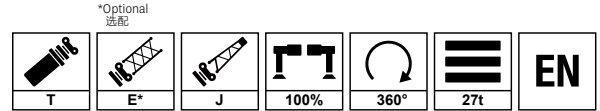

Boom angle 主臂仰角 (°)	75.5m+10.2m			75.5m+17.5m			75.5m+9m	75.5m+19.7m			75.5m+27m			Boom angle 主臂仰角 (°)
	0°	15°	30°	0°	15°	30°	0°	0°	15°	30°	0°	15°	30°	
18	5.5						7.5							18
20	5.5	4					7							20
22	5.3	4	3.3	3.7			6.5							22
24	5.2	4	3.3	3.6			6.2	3.4						24
26	5	4	3.3	3.5	2.4		5.5	3.3	2.7					26
28	4.7	3.9	3.2	3.5	2.3		5.2	3.2	2.6	2.1	2.3			28
30	4.3	3.9	3.2	3.3	2.3	1.6	4.5	3.1	2.6	2	2.2	1.5		30
32	3.8	3.7	3.2	3.1	2.2	1.6	4	3	2.5	2	2	1.5	1.3	32
34	3.3	3.3	3.1	3	2.2	1.6	3.5	3	2.4	1.9	1.8	1.4	1.2	34
36	2.9	2.9	2.9	2.8	2.1	1.6	3.1	2.9	2.3	1.9	1.7	1.3	1.2	36
38	2.5	2.5	2.5	2.7	2	1.5	2.7	2.7	2.2	1.8	1.6	1.2	1.2	38
40	2.2	2.2	2.2	2.4	1.9	1.5	2.3	2.4	2	1.8	1.5	1.2	1.2	40
42	1.9	1.9	1.9	2.1	1.8	1.5	2	2.1	1.9	1.7	1.4	1.2	1.1	42
44	1.6	1.6	1.6	1.9	1.8	1.4	1.7	1.8	1.8	1.7	1.3	1.1	1.1	44
46	1.4	1.4	1.4	1.6	1.7	1.4	1.5	1.5	1.5	1.5	1.3	1.1	1.1	46
48	1.2	1.2	1.2	1.4	1.5	1.3	1.3	1.3	1.3	1.3	1.2	1.1	1.1	48
50	1	1	1	1.2	1.3	1.3	1	1.1	1.1	1.1	1.2	1	1	50
52		0.8	0.8	1.1	1.1	1.2	0.8	0.8	0.9	0.9	1.1	1	1	52
54				0.9	0.9	1					1	1	1	54
56					0.8	0.9					0.8	0.9	0.9	56
58													0.8	58
Rope rate 钢丝绳倍率	1													Rope rate 钢丝绳倍率



## SANY GROUP CRANE BU

SANY Mobile Crane Industrial Park, No.168 Jinzhou Avenue, Jinzhou Development Zone, Changsha City,  
Hunan Province, P.R. China Zip 410600  
Consulting [sanycrane@sanygroup.com](mailto:sanycrane@sanygroup.com) (Crane BU) / [crd@sany.com.cn](mailto:crd@sany.com.cn) (IHQ)  
After-sales Service 0086-400 6098 318

Reminder:

Any change in the technical parameters and configuration due to product modification or upgrade may occur without prior notice. The machine in the picture may include additional equipment. This brochure is for reference only, and goods in kind shall prevail.

Copyright at SANY. No part of this brochure may be copied or used for any purpose without written approval from SANY.

© Edited in August 2022

### 三一集团起重事业部

中国湖南长沙金洲开发区金洲大道 168 号 三一汽车起重机产业园 邮编: 410600  
咨询: [sanycrane@sanygroup.com](mailto:sanycrane@sanygroup.com) (起重事业部) / [crd@sany.com.cn](mailto:crd@sany.com.cn) (国际总部)  
海外售后服务: 0086-400 6098 318

温馨提示:

由于技术不断更新, 技术参数及配置如有更改, 恕不另行通知。图中机器可能包括附加设备, 本画册仅供参考, 以实物为准。  
版权为三一所有, 未经三一书面许可, 本画册任何内容不得被复制用于任何目的。

© 2022 年 8 月版

