

Data Sheet | Item Number: 855-401/250-501

Plug-in current transformer; Primary rated current: 250 A; Secondary rated current: 1 A; Rated power: 5 VA; Accuracy class: 1

<https://www.wago.com/855-401/250-501>



Similar to illustration

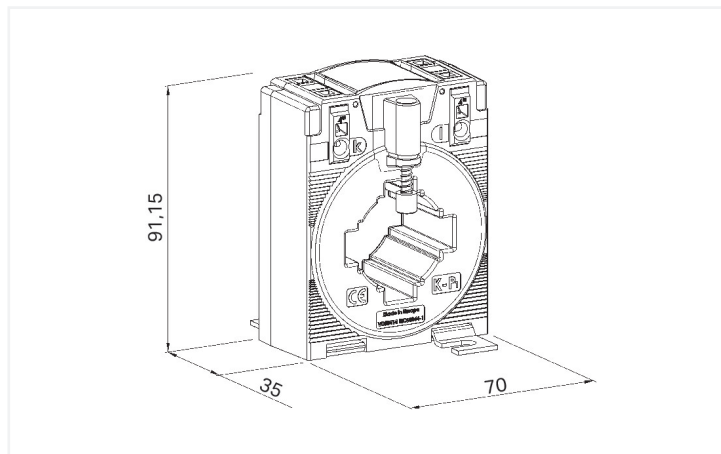

Dimensions in mm

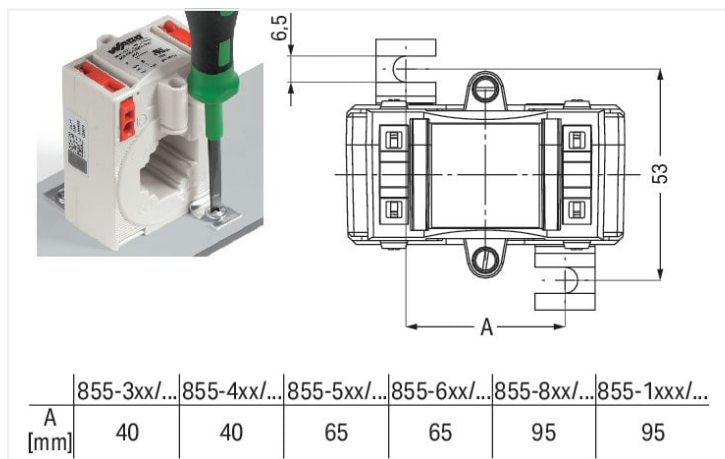

Dimensions in mm

Short description:

These plug-in units (855 Series) are inductive, single-conductor current transformers. Due to the measurement principle used, these current transformers are exclusively designed for AC network applications. **Features:**

- Screwless CAGE CLAMP® connection technology
- Several mounting options available
- Vibration- and shock-resistant
- High mechanical retention forces
- High current-carrying capacity
- Continuous overload of 120% the nominal primary current
- Low-voltage current transformer for operating voltages up to max. 1.2 kV
- For 690 V power networks
- UL recognized components

Technical data

Input current transformers

Primary rated current	250 A
Rated continuous thermal current I_{cth}	$1.2 \times I_N$
Rated short-time thermal current I_{th}	$60 \times I_N / 1 \text{ s (max. } 100 \text{ kA / 1 s)}$
Overcurrent limiting factor	FS5 / FS10 (type dependent; see type plate inscription)
Rated frequency	50 ... 60 Hz

Output (current transformer)

Secondary rated current	1 A
Rated power S_r	5 VA

Measurement error

Accuracy class	1
----------------	---

Safety and protection

Highest voltage for equipment Um	AC 1.2 kV _{rms}	Test voltage	
		Test voltage	AC 6 kV; 50 Hz; 1 min

Connection data

Connection technology	CAGE CLAMP®
Solid conductor	0.08 ... 4 mm ² / 28 ... 12 AWG
Fine-stranded conductor	0.08 ... 4 mm ² / 28 ... 12 AWG
Strip length	9 ... 10 mm / 0.35 ... 0.39 inches

Physical data

Width	70 mm / 2.756 inches
Height	91.15 mm / 3.589 inches
Depth	52 mm / 2.047 inches

Mechanical data

Mounting type	Closed current transformer Installation on mounting plate Mounting on DIN-rail via DIN-rail adapter Installation on round cable
---------------	--

Material data

Insulation class	E
Fire load	0 MJ
Weight	370 g

Environmental requirements

Ambient temperature (operation)	-5 ... +50 °C
Ambient temperature (storage)	-25 ... +70 °C
Operating altitude (max.)	1000 m

Standards and specifications

Conformity marking	CE
Standards/specifications	EN 61869-1 EN 61869-2 UL: E356480

Commercial data

eCl@ss 10.0	27-21-09-02
eCl@ss 9.0	27-21-09-02
ETIM 8.0	EC002048
ETIM 7.0	EC002048
PU (SPU)	1 pcs
Packaging type	Box
Country of origin	HU
GTIN	4055143523226
Customs tariff number	85043129900

Environmental Product Compliance

RoHS Compliance Status	Compliant, No Exemption
------------------------	-------------------------