

FLUKE.

64 Max

IR Thermometer

Users Manual

January 2017
© 2017 Fluke Corporation. All rights reserved. Specifications are subject to change without notice.
All product names are trademarks of their respective companies.

LIMITED WARRANTY AND LIMITATION OF LIABILITY

This Fluke product will be free from defects in material and workmanship for three years from the date of purchase. This warranty does not cover fuses, disposable batteries, or damage from accident, neglect, misuse, alteration, contamination, or abnormal conditions of operation or handling. Resellers are not authorized to extend any other warranty on Fluke's behalf. To obtain service during the warranty period, contact your nearest Fluke authorized service center to obtain return authorization information, then send the product to that Service Center with a description of the problem.

THIS WARRANTY IS YOUR ONLY REMEDY. NO OTHER WARRANTIES, SUCH AS FITNESS FOR A PARTICULAR PURPOSE, ARE EXPRESSED OR IMPLIED. FLUKE IS NOT LIABLE FOR ANY SPECIAL, INDIRECT, INCIDENTAL OR CONSEQUENTIAL DAMAGES OR LOSSES, ARISING FROM ANY CAUSE OR THEORY. Since some states or countries do not allow the exclusion or limitation of an implied warranty or of incidental or consequential damages, this limitation of liability may not apply to you.

11/99

Table of Contents

Title	Page
Introduction.....	1
How to Contact Fluke	1
Safety Information	2
Features	5
Overview.....	6
Settings Menu	6
Basic Features	10
Advanced Features	12
EMS setting	12
ALARM	13
Select MAX/MIN/AVG/DIF.....	14
SAVE and Review the Records.....	16
Lock the Measurement.....	19
Trigger Lock	19
Auto Capture	20
Set Temperature Units	22

64 Max
Users Manual

Set Date and Time	23
Aiming and Measurement	24
Maintenance.....	27
Change the Battery	27
Clean the Product	27
Specifications	29
Safety	30
Electromagnetic Compatibility.....	31

Introduction

The Fluke 64 Max IR Thermometer (the Product) can determine the surface temperature by measuring the amount of infrared energy radiated by the target's surface.

Warning

Read all safety information before you use the Product.

Safety Information

A **Warning** identifies conditions and procedures that are dangerous to the user. A **Caution** identifies conditions and procedures that can cause damage to the Product or the equipment under test.

Table 1 lists the symbols used on the Product and in this manual.

Warning







To prevent eye damage and personal injury:

- **Read all safety Information before you use the Product.**
- **Do not use the Product if it operates incorrectly.**
- **Use the Product only as specified, or the protection supplied by the Product can be compromised.**
- **Before you use the Product, inspect the case. Do not use the Product if it appears damaged. Look for cracks or missing plastic.**

***IR Thermometer
Safety Information***

- See emissivity information for actual temperatures. Reflective objects result in lower than actual temperature measurements. These objects pose a burn hazard.
- Do not look directly into the laser with optical tools (for example, binoculars, telescopes, microscopes). Optical tools can focus the laser and be dangerous to the eye.
- Do not look into the laser. Do not point laser directly at persons or animals or indirectly off reflective surfaces.
- Replace the batteries when the low battery indicator shows to prevent incorrect measurements.
- Do not use the Product around explosive gas, vapor, or in damp or wet environments.
- Use the Product only as specified or hazardous laser radiation exposure can occur.

Table 1. Symbols

Symbol	Meaning	Symbol	Meaning
	WARNING. RISK OF DANGER.		Warning. Laser.
	Consult user documentation.		Conforms to European Union directives.
	Conforms to relevant Australian EMC standards.		
	Indicates a Class 2 laser. DO NOT STARE INTO BEAM The following text may appear with the symbol on the product label: "IEC/EN 60825-1 Complies with 21 CFR 1040.10 and 1040.11 except for deviations pursuant to Laser Notice 50, dated June 24, 2007." In addition, the following pattern on the label will indicate wavelength and optical power: $\lambda = xxxnm, x.xxmW$		
	This product complies with the WEEE Directive marking requirements. The affixed label indicates that you must not discard this electrical/electronic product in domestic household waste. Product Category: With reference to the equipment types in the WEEE Directive Annex I, this product is classed as category 9 "Monitoring and Control Instrumentation" product. Do not dispose of this product as unsorted municipal waste.		

Features

The Product features:

- Single-spot laser sighting
- Backlight display
- Lighting LED
- Current temperature plus MAX, MIN, DIF, AVG temperature displays
- 1 AA battery
- Adjustable emissivity
- Auto off
- Printed 64 Max Instructions
- 24-hour clock
- Appointment measurement
- Monitoring measurement
- Ambient alarm
- Lower battery alarm
- IP54
- 3 meter drop
- Last reading Hold (7 seconds)
- High and low alarm
- Data storage and review
- Trigger lock
- Trigger protection

Overview

To turn on the Product, pull the trigger. The Product has a two-level menu. Use the menu to select features, turn on or turn off Product features, or for more detailed configurations. For a full view of the Product, see Figure 1. For a view of the laser and LCD (display), see Figure 2.

Settings Menu

To put the Product into HOLD status, pull and release the trigger. **HOLD** shows on the display. When the Product is in HOLD status, push the **SEL** button once to enter the first-level settings. Top-level settings include:

- ☹ (Light)
- ☀ (Backlight)
- ▲ (Laser)
- ALARM (⚡, HI, and LO)
- EMS (Emissivity)
- MAX/MIN/DIFF/AVG
- **REC** (Record)

*IR Thermometer
Overview*

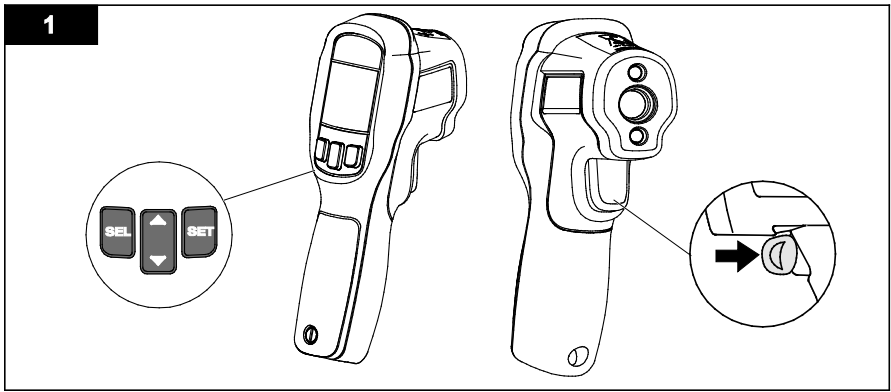

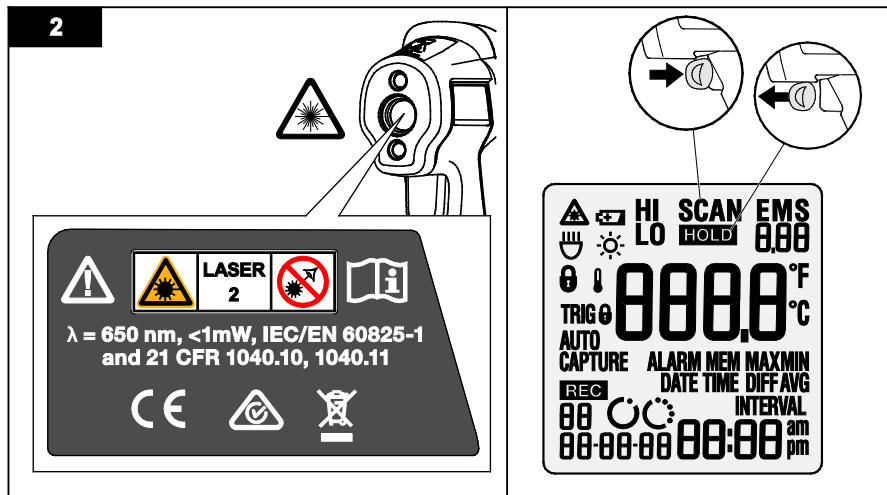

iba02.eps



iba01.eps

IR Thermometer
Overview

When the Product is in HOLD status, push and hold **SEL** for >3 seconds to enter the second-level menu. Second-level menu settings include:

- TRIG  (Trigger Lock)
-  (Lock)
- AUTO CAPTURE (TIME)
- AUTO CAPTURE (INTERVAL)
- DATE
- TIME
- TEMPERATURE UNIT





From either menu, push **SEL** to step through each feature. The last push goes back to HOLD status.

To set a feature or parameter, pull the trigger to save the option and return to HOLD status.

64 Max
Users Manual

Basic Features

These settings are either on or off:

-  (Light) See Figure 3.
-  (Backlight) See Figure 4.
-  (Laser) See Figure 5.
-  (Lock)
- TRIG  (Trigger Lock)

To change these settings:

1. When the Product is in HOLD status, push **SEL** to enter the first or second-level menu.
2. Push **SEL** several times until the feature shows on the display.
3. Push the **SET** button to change the ON or OFF status.
4. Push **SEL** several times or pull the trigger to quit the process and return to HOLD status.

Note

The Product laser is for aiming purposes only. The laser turns off when you release the trigger.

IR Thermometer
Overview

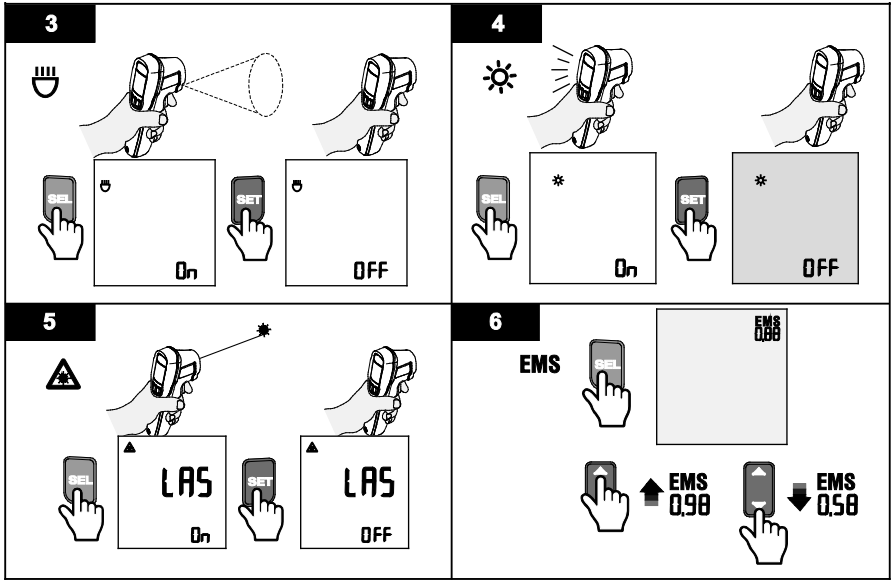

iba14.eps

Advanced Features

Advanced features are listed below.

EMS setting

Make measurements with the correct EMS value to ensure accuracy.

To adjust the EMS value: (See Figure 6 and Table 2)

1. In HOLD status, push **SEL** several times until **EMS** and its value are shown in the upper-right corner.
2. Push ▲ or ▼ to adjust the EMS value as necessary.
3. Push **SEL** several times or pull the trigger to quit the process and return to HOLD status.

ALARM

The alarm icon (**ALARM**) flashes to indicate an alarm condition.

To set the alarm (see Figures 7 and 8):

1. In HOLD status, push **SEL** several times until **ALARM** shows on the display.
2. The ambient temperature icon (⚡) shows on the display. Push **SET** to turn it on or off. When it is on, the icon flashes when the Product detects ambient temperature drifts to the higher or lower extremes of the ambient temperature range. In this condition, the readings do not reflect actual temperature and should not be trusted.
3. Push **SEL** to change to a high or low alarm (the display shows "HI" or "LO").
4. Push **SET** to turn the alarm feature On or OFF. When the HI / LO alarm is on, the alarm value shows in the lower right of the display.
5. Push ▲ or ▼ to change the setting value as necessary (see Figure 7).
6. Push **SEL** several times or pull the trigger to quit the process and return to HOLD status.

64 Max
Users Manual

Select MAX/MIN/AVG/DIF

To select MAX, MIN, AVG, or DIF, see Figure 9:

1. In HOLD status, push **SEL** until MAX (MIN/AVG/DIF) shows.
2. Push **SET** to select MAX, MIN, AVG, or DIF.
3. Push **SEL** several times or pull the trigger to exit the setup. The feature selected is shown on the display.

Note

You can select only one of MAX, MIN, AVG, or DIF.

IR Thermometer
Overview

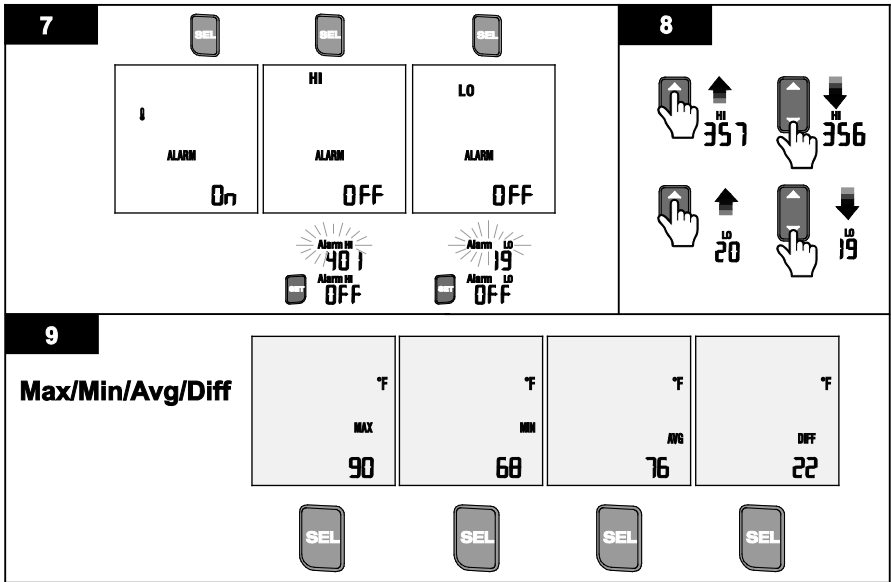

iba15.eps

SAVE and Review the Records

To save readings:

1. Pull the trigger to take a measurement.
2. Release the trigger to stop the measurement and go back to HOLD status.
3. Push **SET** to save the reading.

REC and a two-digit number below it shows on the display for approximately 1 second and then disappears. This means that the reading has been saved into memory at the two-digit location. The Product also saves a time and date stamp and the EMS value.

To review saved readings:

1. In HOLD status, push **SEL** to step through the first level menu until **REC** shows on the display. The latest record shows on the display. The record includes the reading, EMS value, and the date and time stamp.
2. Push **▲** or **▼** to review each record. A two-digit number below **REC** shows the current record number (from 01 to 99).

Note

*You cannot save a reading if the memory is full. If you push **SET** to save a new reading when the memory is full, the last record flashes twice to remind you that the memory is full, and the reading is not saved.*

To delete a single saved reading:

- In record review status, push and hold **SET** for approximately 3 seconds. The reading flashes once and is deleted.

After the deletion, all remaining records move one position forward. For example, if the deleted record was in position "08", then the record on "09" becomes the new "08" record.

To delete all saved readings:

- In record review status, push and hold **SET** for approximately 10 seconds. At 3 seconds, the display flashes to warn that all data will be lost. Continue to push **SET** to delete all the records. To cancel this operation, release **SET** before you reach 10 seconds.

Once all records are deleted, the record count returns to "00".

Table 2. Nominal Surface Emissivity

Material	Value	Material	Value
Default****	0.95	Glass	0.85
Aluminum*	0.30	Iron*	0.70
Asbestos	0.95	Lead*	0.50
Asphalt	0.95	Oil	0.94
Brass*	0.50	Paint	0.93
Ceramic	0.95	Plastic**	0.95
Concrete	0.95	Rubber	0.95
Copper*	0.60	Sand	0.90
Food-Frozen	0.90	Steel*	0.80
Food-Hot	0.93	Water	0.93
		Wood	0.94
* Oxidized ** Opaque, over 20 mils *** Natural **** Factory Setting			

Lock the Measurement

Use this feature to take continuous readings automatically without the need to pull the trigger.

To use the lock feature:

1. In HOLD status, push **SEL** for approximately 3 seconds to enter in the second level menu. **🔒** shows on the display.
2. Push **SET** to enable the lock feature. The product exits the setup and starts to continually measure.
3. Push **SET** or pull the trigger to stop the measurement as necessary. The Product returns to setup status.

Trigger Lock

This feature conserves battery power when the Product is stored. For example, if the Product is stored inside a toolbox so that the trigger is pulled for >10 minutes, the Product turns itself off to save the battery. To use this feature:

1. In HOLD status, push **SEL** for approximately 3 seconds to enter the second-level menu.
2. Push **SEL** until **TRIG 🔒** shows on the display.
3. Push **SET** to switch the feature on or off.
4. Push **SEL** several times or pull the trigger to return to HOLD status.

Auto Capture

Use this feature to make a measurement at a specific time (within 24 hours) or to make repeated measurements (Interval monitoring).

For a one-time measurement: The Product automatically wakes up at the specified time, makes a measurement, and saves the reading. Once the reading is saved, the feature turns off. To make a one-time measurement:

1. In HOLD status, push **SEL** >3 seconds to enter the second-level menu.
2. Push **SEL** until **AUTO CAPTURE** and **TIME** show on the display.
3. Push **SET** to switch the feature on or off.
4. When it is on, push ▲ or ▼ to adjust the time.
5. Push **SEL** several times or pull the trigger to exit the setup.

Note

- *When the Auto Capture feature is on, **AUTO CAPTURE** shows on the display when the Product is in SCAN and HOLD status.*
- *If the memory is full (all 99 positions of data storage are occupied), you cannot turn on this feature.*

For Interval monitoring: The Product counts down from the time interval, wakes up automatically and makes a measurement, and then saves the reading. The Product then goes to sleep, restarts the count down and repeats the process. The feature automatically turns off when the memory is full or you turn off the feature. To make repeated measurements at a specified interval:

1. In HOLD status, push **SEL** for >3 seconds to enter in the second-level menu.
2. Push **SEL** until **AUTO CAPTURE** and **INTERVAL** show on the display.
3. Push **SET** to switch the feature on or off.
4. When the feature is on, push ▲ or ▼ to adjust the displayed value as necessary. The displayed value is the start value of the countdown counter.
5. Push **SEL** several times or pull the trigger to exit the setup.

Note

- *If the Interval monitoring feature is turned on when Auto Capture is already on, both features work together. The automatic measurement will be at the time set for Auto Capture. This allows the user to select the specified time to start the Interval monitoring measurement.*

64 Max
Users Manual

- *If the memory is full, the feature cannot be switched ON.*
- *When the feature is on, **AUTO CAPTURE** shows on the display when the Product is in SCAN and HOLD status.*
- *When records are saved into memory, the new data will be saved starting from the first empty memory location until all 99 positions are used.*

Set Temperature Units

To set the temperature units:

1. In HOLD status, push the **SEL** button for >3 seconds to enter the second-level menu.
2. Push **SEL** several times until °F or °C shows on the display.
3. Push **SET** to toggle the units.
4. Push **SEL** or pull the trigger to accept the format.

Set Date and Time

To set the Date and Time:

1. In HOLD status, push the **SEL** button for >3 seconds to enter the second-level menu.
2. Push **SEL** several times until **DATE** shows on the display.
3. Push **SET** to toggle the year formats.
4. Push **SEL** to accept the format and start the date adjustment.
5. The active item flashes, push ▲ or ▼ to adjust the value and then push **SEL** to move to the next item.
6. When the date is complete, push **SEL** until **TIME** shows on the display.
7. Push **SET** to toggle a 12 hour or 24 hour display.
8. Push **SEL** to accept the time format and start the time adjustment.
9. The active item flashes, push ▲ or ▼ to adjust the value and then push **SEL** to move to the next item.
10. Push **SEL** or pull the trigger to exit the setup.

Aiming and Measurement

Figures 10 through 13 show how to aim and take measurements with the Product.

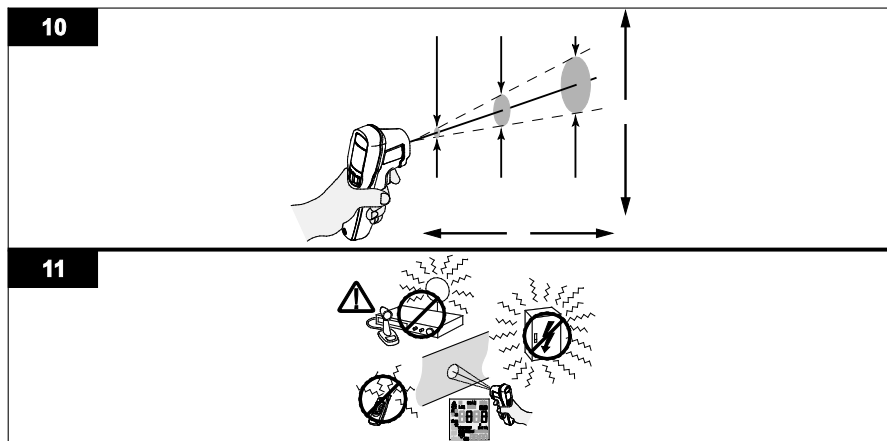

iba17.eps

IR Thermometer
Aiming and Measurement

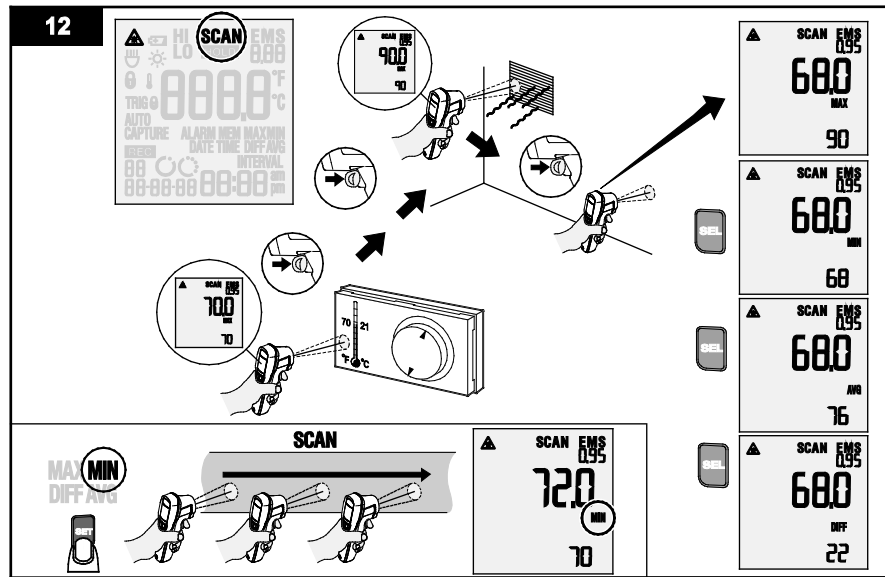

iba03.eps

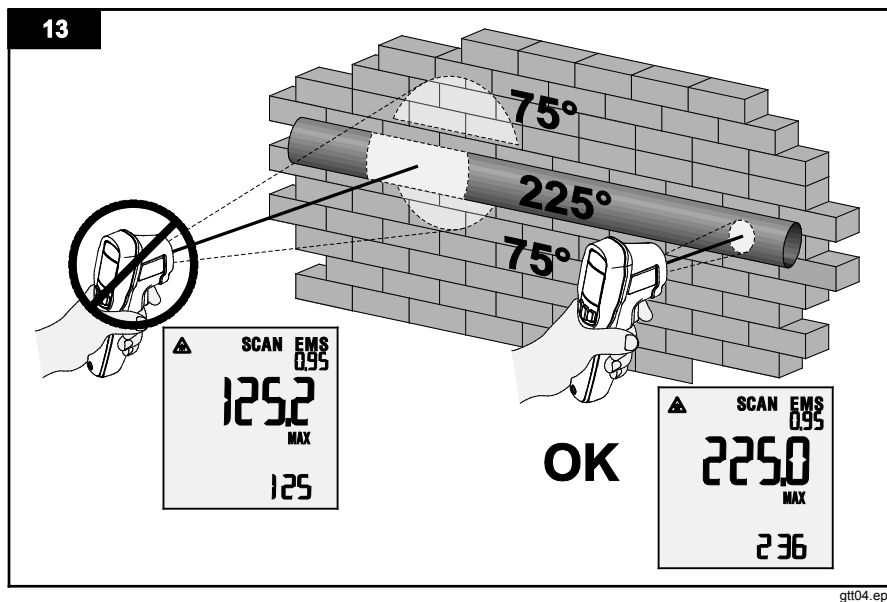

Maintenance

⚠ Caution

To avoid damage to the Product, do not leave the thermometer on or near objects of high temperature.

Change the Battery

To install or change the AA IEC LR06 battery, open the battery compartment and replace the battery as shown in Figure 14.

Note

To prevent the loss of the set date, time, and status of appointment and monitoring, remove and insert a new battery when the Product is in sleep mode and complete the operation within 10 seconds.

Clean the Product

Use soap and water on a damp sponge or soft cloth to clean the Product case. Carefully wipe the lens surface with a moist cotton swab. The swab may be moistened with water. See Figure 15.

64 Max
Users Manual

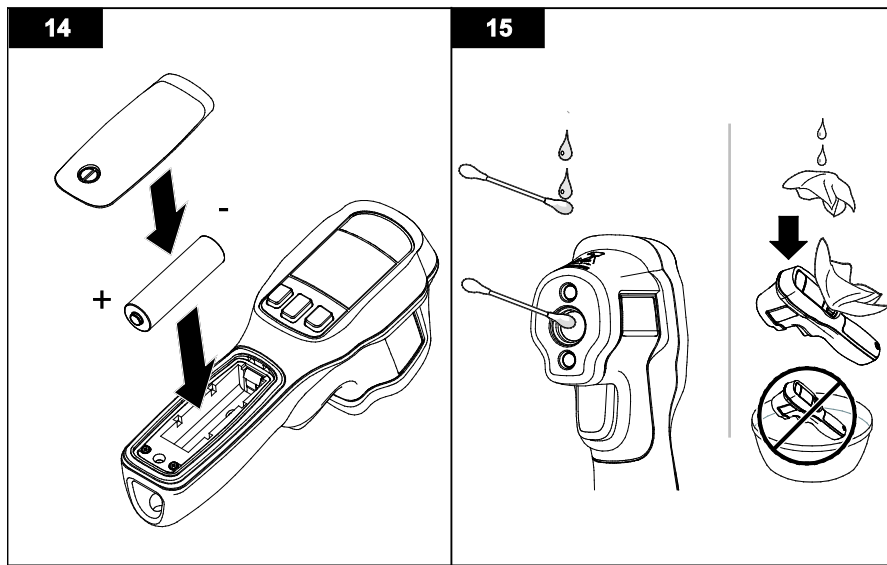

gft13.eps

**IR Thermometer
Specifications**

Specifications

Temperature Range	-30 °C to +600 °C
Accuracy (Calibration geometry with ambient temperature 23 °C ±2 °C)	≥0 °C: ±1 °C or ±1 % of reading, whichever is greater ≥ -10 °C to <0 °C: ±2 °C < -10 °C: ±3 °C
Response Time (95 %)	<500 ms (95 % of reading)
Spectral Response	8 microns to 14 microns
Emissivity	0.10 to 1.00
Temperature Coefficient	±0.1 °C/°C or ±0.1 %/°C of reading (whichever is greater)
Optical Resolution	20:1 (calculated at 90 % energy)
Display Resolution	0.1 °C
Repeatability (% of reading)	±0.5 % of reading or ±0.5 °C, whichever is greater
Power	1 AA IEC LR06 Battery
Battery Life	30 hours with laser and backlight on

64 Max
Users Manual

Weight	255 g
Size	175 x 85 x 75 mm
Operating Temperature	0 °C to 50 °C
Storage Temperature	-20 °C to +60 °C, (without battery)
Operating Humidity	Non Condensing (≤ 10 °C) ≤ 90 % RH (at 10 °C to 30 °C) ≤ 75 % RH (at 30 °C to 40 °C) ≤ 45 % RH (at 40 °C to 50 °C)
Operating Altitude	2000 meters above mean sea level
Storage Altitude	12 000 meters above mean sea level

Safety

General	IEC 61010-1: Pollution Degree 2
Laser	IEC 60825-1: Class 2, 650 nm, <1 mW
Ingress Protection	IEC 60529: IP54

Electromagnetic Compatibility

International IEC 61326-1: Portable; IEC 61326-2-2; CISPR 11: Group 1, Class A

Group 1: Equipment has intentionally generated and/or uses conductively-coupled radio frequency energy that is necessary for the internal function of the equipment itself.

Class A: Equipment is suitable for use in all establishments other than domestic and those directly connected to a low-voltage power supply network that supplies buildings used for domestic purposes. There may be potential difficulties in ensuring electromagnetic compatibility in other environments due to conducted and radiated disturbances.

Caution: This equipment is not intended for use in residential environments and may not provide adequate protection to radio reception in such environments.

Korea (KCC) Class A Equipment (Industrial Broadcasting & Communication Equipment)

Class A: Equipment meets requirements for industrial electromagnetic wave equipment and the seller or user should take notice of it. This equipment is intended for use in business environments and not to be used in homes.

USA (FCC) 47 CFR 15 subpart B. This product is considered an exempt device per clause 15.103.