

## Glass Passivated Bridge Rectifiers

### FEATURES

- Glass passivated junction
- Ideal for printed circuit board
- Reliable low cost construction
- UL Recognized File # E-326243
- Compliant to RoHS Directive 2011/65/EU and in accordance to WEEE 2002/96/EC
- Halogen-free according to IEC 61249-2-21 definition



KBL



### MECHANICAL DATA

**Case:** KBL

Molding compound, UL flammability classification rating 94V-0

Base P/N with suffix "G" on packing code - halogen-free

**Terminal:** Matte tin plated leads, solderable per JESD22-B102

Meet JESD 201 class 1A whisker test

**Polarity:** Polarity as marked on the body

**Weight:** 5.6 g (approximately)

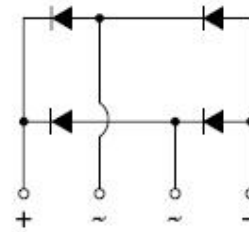

### MAXIMUM RATINGS AND ELECTRICAL CHARACTERISTICS (T<sub>A</sub>=25°C unless otherwise noted)

PARAMETER	SYMBOL	KBL	KBL	KBL	KBL	KBL	KBL	KBL	Unit
		401G	402G	403G	404G	405G	406G	407G	
Maximum repetitive peak reverse voltage	V <sub>RRM</sub>	50	100	200	400	600	800	1000	V
Maximum RMS voltage	V <sub>RMS</sub>	35	70	140	280	420	560	700	V
Maximum DC blocking voltage	V <sub>DC</sub>	50	100	200	400	600	800	1000	V
Maximum average forward rectified current	I <sub>F(AV)</sub>	4							A
Peak forward surge current, 8.3 ms single half sine-wave superimposed on rated load	I <sub>FSM</sub>	150							A
Rating for fusing (t<8.3mS)	I <sup>2</sup> t	93							A <sup>2</sup> s
Maximum instantaneous forward voltage (Note 1) I <sub>F</sub> = 2A I <sub>F</sub> = 4A	V <sub>F</sub>	1.0 1.1							V
Maximum DC reverse current at rated DC blocking voltage	I <sub>R</sub>	10 500							μA
Typical thermal resistance	R <sub>θJL</sub> R <sub>θJA</sub>	2.4 19							°C/W
Operating junction temperature range	T <sub>J</sub>	- 55 to +150							°C
Storage temperature range	T <sub>STG</sub>	- 55 to +150							°C

Note 1: Pulse Test with PW=300μs, 1% Duty Cycle

**ORDERING INFORMATION**

PART NO.	PACKING CODE	GREEN COMPOUND CODE	PACKAGE	PACKING
KBL40xG (Note 1)	T0	Suffix "G"	KBL	500 / Tray

Note 1: "x" defines voltage from 50V (KBL401G) to 1000V (KBL407G)

**EXAMPLE**

PREFERRED P/N	PART NO.	PACKING CODE	GREEN COMPOUND CODE	DESCRIPTION
KBL407G T0	KBL407G	T0		
KBL407G T0G	KBL407G	T0	G	Green compound

**RATINGS AND CHARACTERISTICS CURVES**

(TA=25°C unless otherwise noted)

FIG. 1 FORWARD CURRENT DERATING CURVE

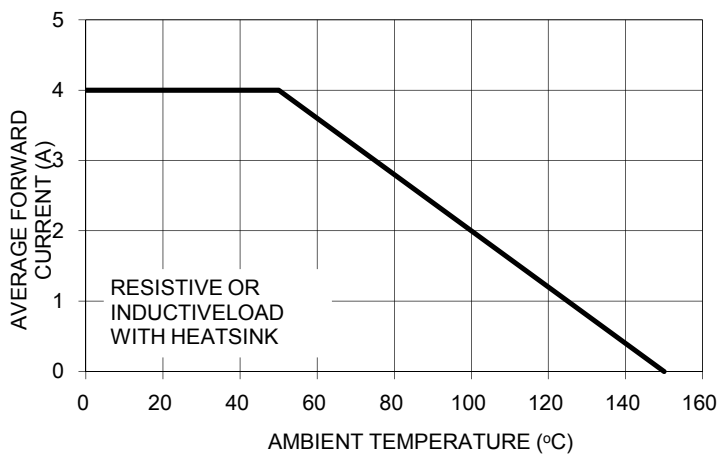

FIG. 2 TYPICAL REVERSE CHARACTERISTICS

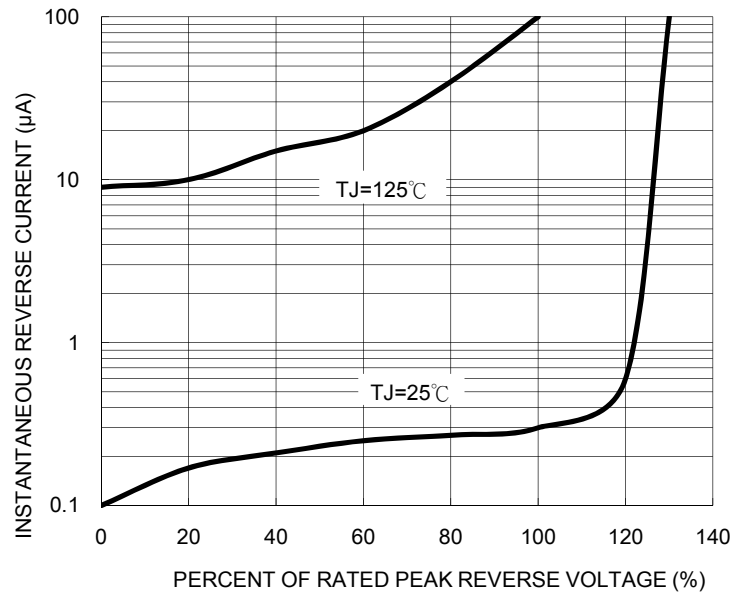

FIG. 3 MAXIMUM NON-REPETITIVE FORWARD SURGE CURRENT

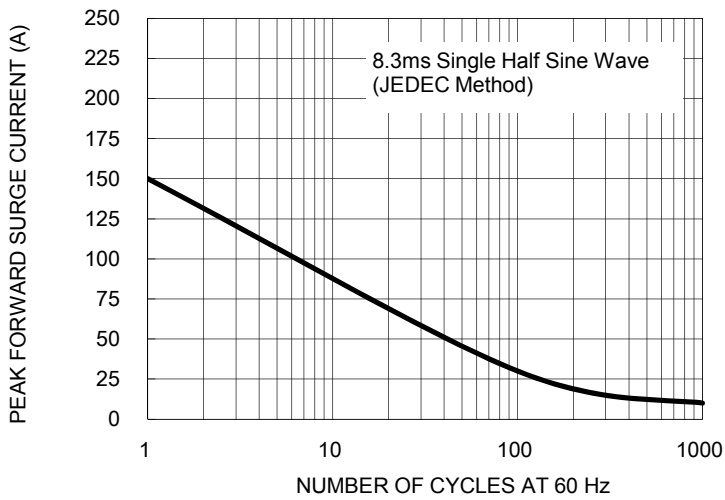

FIG. 4 TYPICAL FORWARD CHARACTERISTICS

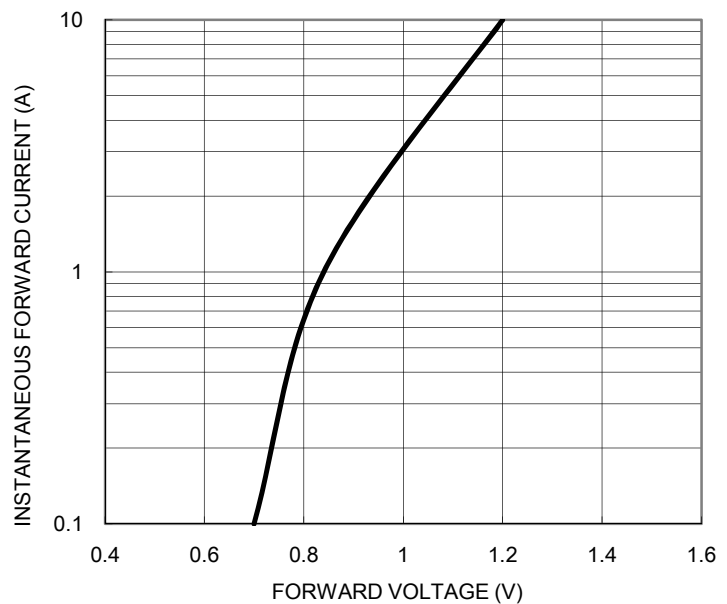
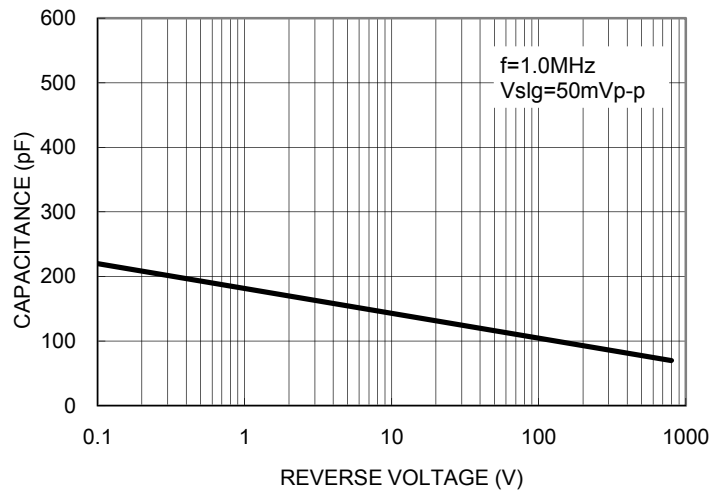
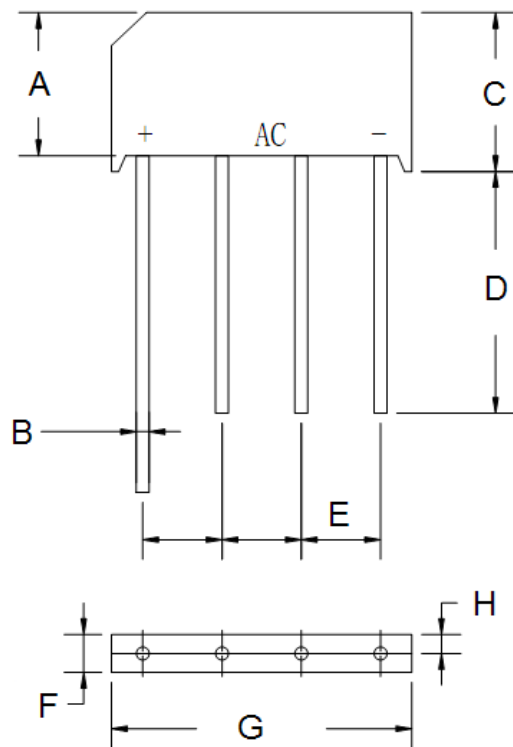

FIG. 5 TYPICAL JUNCTION CAPACITANCE



PACKAGE OUTLINE DIMENSIONS



DIM.	Unit (mm)		Unit (inch)	
	Min	Max	Min	Max
A	13.70	14.70	0.539	0.579
B	1.20	1.30	0.047	0.051
C	15.20	16.30	0.598	0.642
D	19.00	-	0.748	-
E	4.60	5.60	0.181	0.220
F	5.50	6.50	0.217	0.256
G	18.50	19.50	0.728	0.768
H	2.1 (TYP)		0.083 (TYP)	

MARKING DIAGRAM

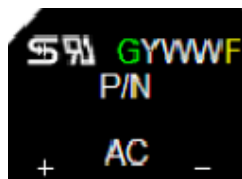

- P/N = Specific Device Code
- G = Green Compound
- YWW = Date Code
- F = Factory Code

## Notice

Specifications of the products displayed herein are subject to change without notice. TSC or anyone on its behalf, assumes no responsibility or liability for any errors inaccuracies.

Information contained herein is intended to provide a product description only. No license, express or implied, to any intellectual property rights is granted by this document. Except as provided in TSC's terms and conditions of sale for such products, TSC assumes no liability whatsoever, and disclaims any express or implied warranty, relating to sale and/or use of TSC products including liability or warranties relating to fitness for a particular purpose, merchantability, or infringement of any patent, copyright, or other intellectual property right.

The products shown herein are not designed for use in medical, life-saving, or life-sustaining applications. Customers using or selling these products for use in such applications do so at their own risk and agree to fully indemnify TSC for any damages resulting from such improper use or sale.