



OpreX™ Analyzers

Process Gas Chromatograph GC8000





Long History of GC Technical Excellence

Yokogawa has a long history of supplying process gas chromatographs to the oil & gas, refining and petrochemical industries around the world. Since their first GC shipped in 1959, Yokogawa has been committed to providing reliable and precise process analytical solutions. Over the past 60 years, the GC products of Yokogawa have continued to evolve to meet the ever changing needs of the process industry.

One common feature of the Yokogawa GCs over the decades has been their commitment to technical excellence. For example research into detector technology has resulted in one of the most sensitive Thermal Conductivity Detectors in the industry with detection limits approaching one part-per-million. Yokogawa GCs also have best-in-class oven temperature control making even complex applications like PIONA possible. And Yokogawa was one of the first GC manufacturers to offer truly redundant Ethernet networking as a standard option.

It is this dedication to technical excellence that drives Yokogawa to continue to push the boundaries of process analysis technologies. And the latest product from that dedication is the GC8000 process gas chromatograph.

GC8000 Process Gas Chromatograph

The GC8000 Process Gas Chromatograph continues Yokogawa's long tradition of process GC excellence with a design that takes the best of emerging technologies yet continues to utilize proven reliable components. The result is a process GC that meets the ever growing demands for analytical reliability and precision while improving the total cost-of-ownership through built-in automated maintenance functions never seen before.

This is made possible by combining the power of modern electronics and software with the 60 years of process chromatography experience within Yokogawa. From the innovative 12-inch color touchscreen HMI to the powerful predictive diagnostics, the GC8000 is truly a process GC for the 21st century.

But the GC8000 is not just all about new electronics; it also brings a number of important innovations in its gas chromatograph analytical capabilities. For the first time, parallel chromatography is made practical with the introduction of the GC Module (GCM) concept. By setting up virtual GCs within a single analyzer, all chromatograph settings, displays, and data are truly segregated for easy understanding and maintenance. There are even built-in graphical overview screens showing each of the individual GC Modules.

The GC8000 sets new standards for process gas chromatography while at the same time offering hardware and electronics that are recognized for robust and reliable operation. Analytical hardware such as the valves and detectors are the same proven hardware used for years in the GC1000 Mark II GC. Yokogawa is also committed to protecting GC1000 Mark II customer's investment in existing installations. In addition to many common spare parts between the two models, the new GC8000 uses the same Ethernet communications network. Updated GC workstation software works with both analyzers on the same network.



- Intuitive touchscreen HMI simplifies analyzer maintenance as well as minimizing training for service technicians
- Built-in Virtual Tech software keeps the GC8000 operating at peak performance
- GC Module (GCM) concept makes parallel chromatography practical for the first time
- Complete compatibility with the existing GC1000 Mark II Ethernet network protects the analytical investment for established customers

Simple Operation At The Touch Of The Screen

The GC8000 has a built-in 12-inch color touchscreen display that dramatically simplifies maintenance. At the touch of the screen, the technician can access all of the analytical parameters and measurement results; displayed in easy-to-understand graphical color screens. From simple overview screens that show the analyzer's operation at a glance to trend displays of Key Performance Indicators (KPI), the user can easily navigate to the information or task that needs to be accomplished.

All the GC operating parameters such as gate and valve times are conveniently displayed on the same screen. This simplifies routine GC maintenance as well as enables technicians new to the GC8000 to quickly begin using the analyzer with minimal training. Chromatograms are also easily called up to compare analysis performance against stored chromatograms or a reference calibration chromatogram.

The GC8000 even has a built in graphics display of how the analyzer is configured making sophisticated applications easier to understand. And with the GC8000's innovative GC Module concept, applications are divided into individual virtual GCs; each with dedicated system clocks (SYS) simplifying even further the GCs configuration. And navigation is as simple as touching the GCM or SYS tabs on the screen.



- Large 12 inch color touchscreen display
- All GC parameters available at a touch of the screen
- Trend reports of analysis results and Key Performance Indicators
- Graphical configuration screens simplifying even complex applications



Advanced Diagnostics and Virtual Tech Software

Leveraging Yokogawa's half century of experience with process chromatography, the GC8000 has an innovative advanced diagnostics (Virtual Tech) package to help keep the unit operating at peak performance. A number of Key Performance Indicators (KPI) are monitored during every analysis to verify the analyzer is operating within proper tolerances. The data monitored includes:

- Chromatogram Shape
- Peak Data
- Valve Data
- Detector Data

When any of the thresholds of monitored parameters are crossed, a pre-alert message is sent to the GC maintenance workstation. Furthermore, an email can be sent that will contain all the measurement data as well as chromatogram in a "zipped" file to a user-defined email address such as the plant's key GC support technician. The technician can then call up and review the long-term performance of the GC through historical KPI data files and trend displays stored on the GC workstation.

The GC8000 also has built-in routines that automatically corrects for many of the common issues of a GC. For example, the GC8000 has an automatic peak alignment capability to correct for shifts in retention time of the peaks without requiring user intervention. Not only does this minimize maintenance but it also allows the GC8000 to be one of the few process GCs that can do demanding applications such as PIONA analysis.

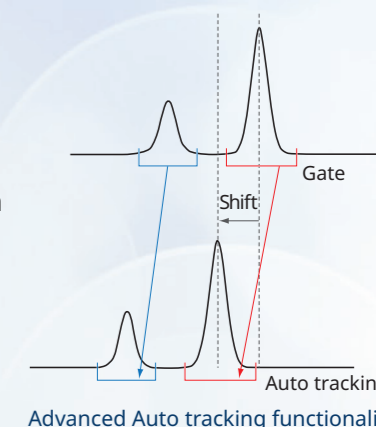

- Automatic Peak Shift Correction minimizes the need for routine peak adjustment

Like Having A Technician Built Into Every GC

Examples of analytical parameters monitored include:

- Retention Time
- Peak Separation
- Tailing Coefficient
- # of Valve Operations



GC Modules Make Parallel Chromatography Practical

One innovative design of the GC8000 software is the GC Module (GCM) concept where all the parameters and functions of a GC application are gathered under one section. For analyzers tackling more than one GC application, this allows everything to be segregated into individual virtual GCs for much easier understanding and maintenance. No longer will the technician need to wonder which valve or peak setting applies to which portion of the GC's application. And navigating between the GCMs is as simple as touching the GCM tabs on the screen.

One example of how the GCM design can help is with Parallel Chromatography. Parallel Chromatography is a powerful tool for process GCs that can often reduce analysis cycle times and hardware complexity. But until the GC8000, the implementation of parallel chromatography was cumbersome and difficult as the software for the different parallel chromatography segments were not segregated from one another. This complexity limited the ability of parallel chromatography to be utilized to its full potential.

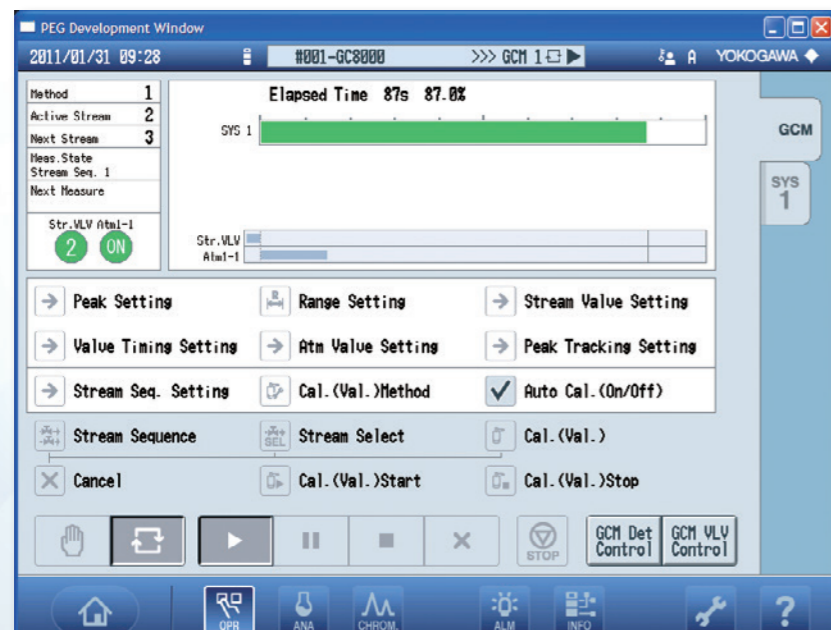

Power to Parallel Chromatography

The Yokogawa GC8000 product line is flexible to design the most effective chromatographically solution with the multiport TCD (MTCD). Supported by our GC laboratory, center of excellence. Combining virtual GC's (GCM) in one GC8000 will reduce foot print at customer installation (Analyzer shelter). The Yokogawa multiport TCD provide unrivaled power by applying parallel chromatography combined with sensitive measurement.

GC8000 can install two large ovens, which contributes saves space by merging two existing units into a single unit. You can create additional installations of GC systems based on the field installation environment.

Virtual GCs can also be set up inside a single GC with GCMs to measure multiple streams simultaneously with minimal impact on the complexity of the GC configuration; significantly reducing the project costs. Not only does this reduce the number of GCs needed but it also reduces the size of the analyzer shelter; leading to even more savings. And with the GCM software and display concept, the added complexity of combining GCs into one unit is dramatically reduced.

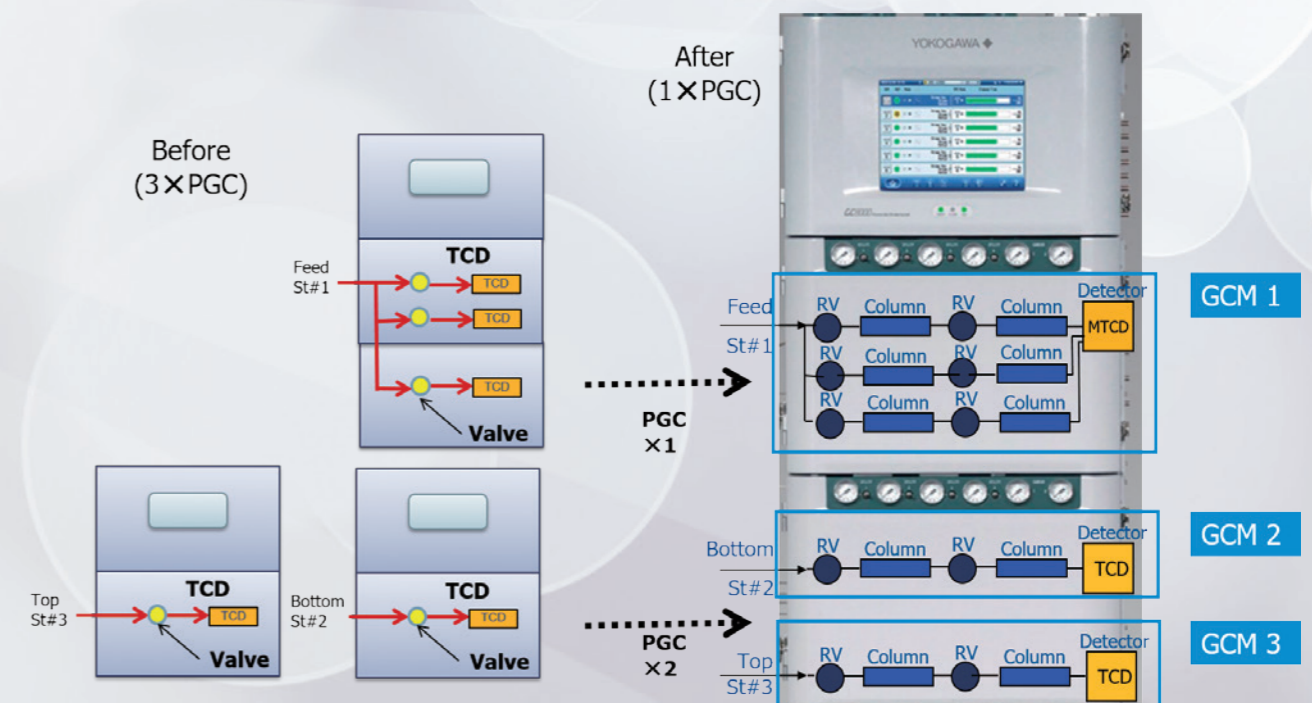

By dividing complex applications into smaller simultaneous measurements, the analyzer complexity as well as analysis time is greatly reduced.

Proven Analytical Hardware

The GC8000 uses the same proven analytical hardware found in our previous model of GC; recognized for its reliable and precise performance. But with the GC8000, the analytical possibilities are greatly expanded through the multiple oven capability of the analyzer. Oven options include:

- Standard Oven (5 valves and 2 detectors max.)
- Large Oven (7 valves and 2 detectors max.)
- Programmed Temperature Oven (to be announced)

Application solutions can be as simple as a single oven performing the desired analysis or can be expanded up to three ovens if the application requires. And through the use of the GCM and SYS application architecture, even the most complex application is kept simple to understand and maintain.

Innovation is found throughout the design of the GC8000 analysis ovens. For example, a unique air distribution fan makes sure that the critical oven temperature is even and stable throughout. As a result, the GC8000 has the tightest oven temperature control in the industry at $\pm 0.03^{\circ}\text{C}$ which leads to more stable analysis. Other innovations include mounting the carrier gas regulators within the temperature controlled oven for unparalleled stability in carrier flow. While Electronic Pressure Controllers (EPCs) are available for this purpose, the Yokogawa carrier gas mechanical regulator mounted in the oven have been shown to perform better in the harsh process environment most GCs are used.

Leading edge innovation is also seen in the detectors used with the GC8000. For example, the Thermal Conductivity Detector (TCD) is one of the most sensitive on the market with the ability to go down into the 1 ppm range for many applications. And when a Flame Ionization (FID) is needed, they are designed for long-term stable operation and can be relit automatically or at the touch of a button with no need to change Air to Fuel ratios.

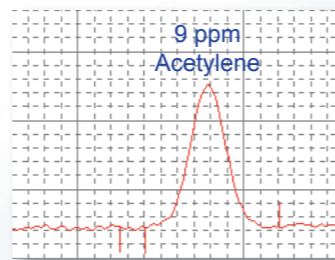
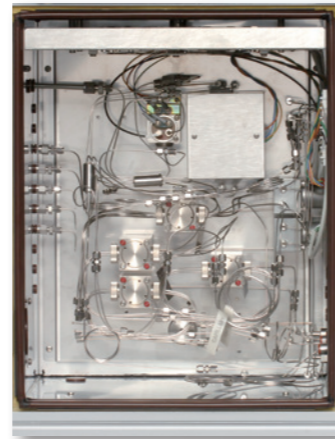

Example of chromatogram with TCD

Flexible and Secure GC Network Design

The communications network of the GC8000 is based on the industry standard Ethernet structure to provide flexible yet secure transmission of data to GC maintenance workstations and the plant DCS system. The GC8000 can be set up for either a single Ethernet network or a redundant network with two completely isolated Ethernet networks if desired.

Built in native Modbus TCP/IP protocol support for network communications eliminates the need for communication gateways to DCS systems in many situations. Not only does this simplify the network architecture, it removes a potential point of failure in delivering analytical data to the DCS system. But for communication systems that still require Serial Modbus gateways, the ASGW is available to fill that role.

And for customer sites with an existing Ethernet network for the GC1000 Mark II, the GC8000 is fully compatible without modification to the network. The only change is the updating of the software used in the GC maintenance workstations to be able to talk to both devices.

Analyzer Management System

The GC network can even be expanded to include the Advanced Analytical Instrument Maintenance Software (AAIMS) that provides real-time asset maintenance management functions for a wide range of on-line process analyzers such as pH and O_2 as well as GCs and FT-NIRs. AAIMS improves the process analysis efficiency by accurately assessing and displaying the KPIs of each analyzer through real-time data acquisition combined with statistical quality control (SQC) analysis. It also provides a common graphical interface for all the plant's analyzers for validation checks and alarm reporting.

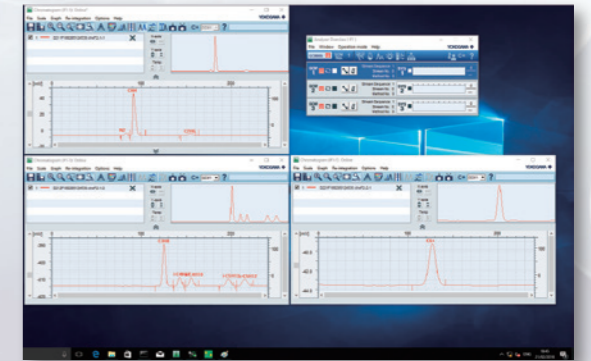

- Innovative rack-and-pinion design for long lasting operation
- Easy to repair with no concern for special torque settings
- Will not contaminate columns on loss of actuation gas like some diaphragm designs
- Configurations available from 4-ports up to 12-ports per valve

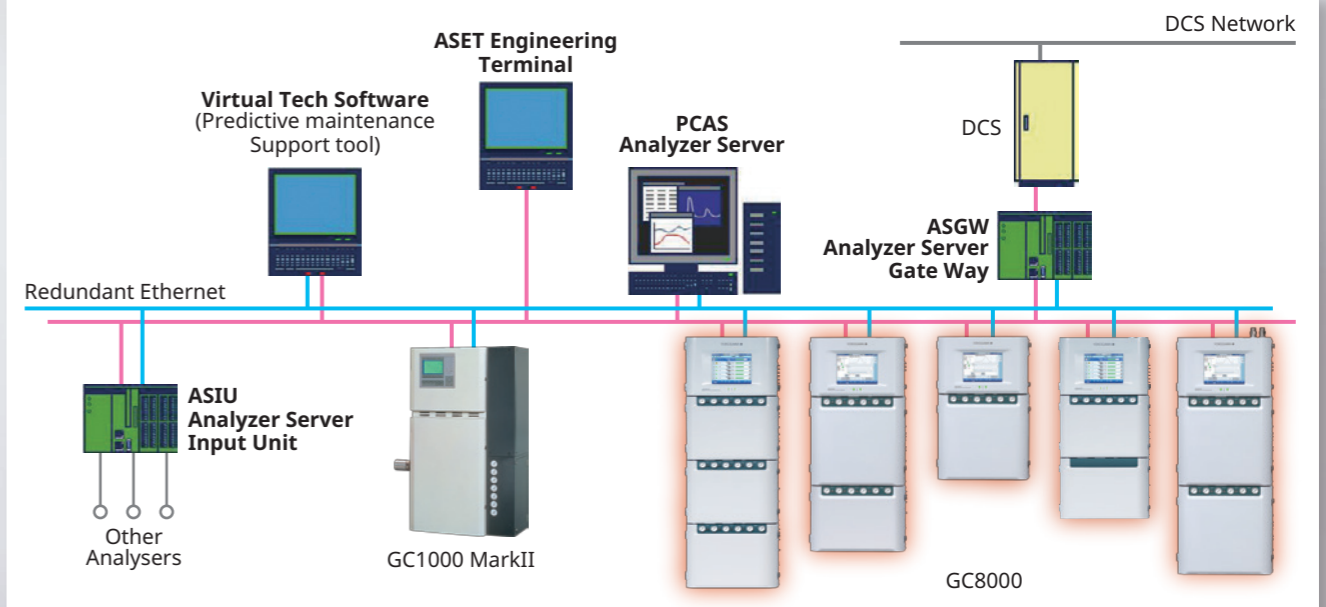

Custom Program Capability

Whether the need is for simple customized reports or sophisticated analysis routines, the GC8000 can be tailored to the user's exact requirements. Using the GC8000's simple Y-Basic software, customized scripts can access any of the parameters within the GC to expand the application flexibility to meet nearly any application. Special calculations using inputs from other process analyzers are even possible.

Analysis and other calculated results can be stored on-board the GC in limited amounts or can be sent to the PCAS GC workstation for nearly unlimited storage capabilities. Chromatograms as well as measurement data can be displayed and trended on both the GC HMI screen as well as the screen of the GC workstation. All data stored within the PCAS workstation can be easily exported to popular PC software such as Microsoft Excel®.



Configurations

Type 1



Type 2

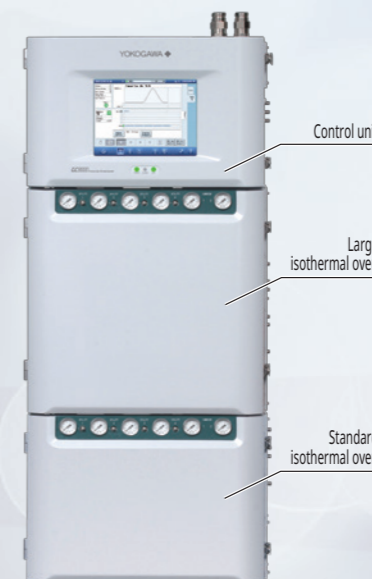

Type 3

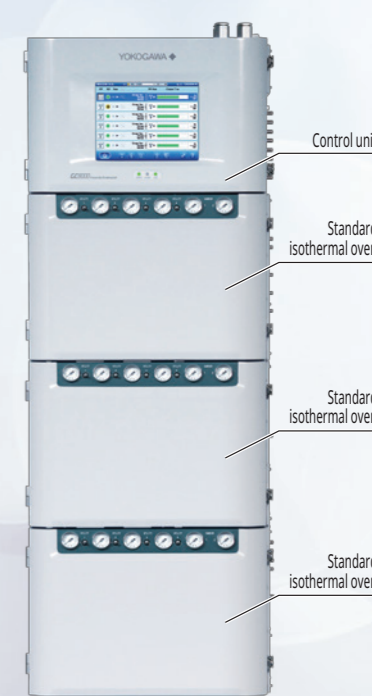

Type 4



Type 5

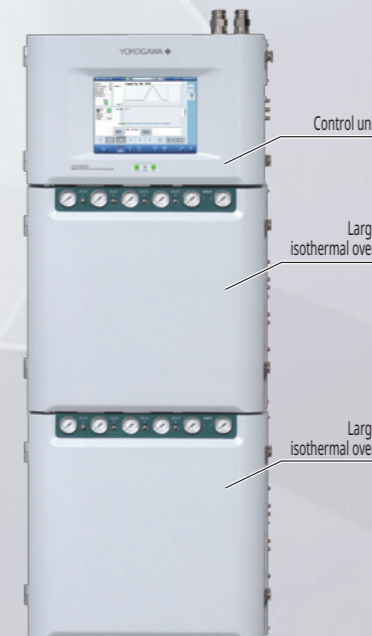

Global Yokogawa Capabilities and Support

The GC8000 Process Gas Chromatograph is just one of many excellent analytical products from Yokogawa Corporation. With a comprehensive line of process liquid and gas analyzers combined with complete analyzer system integration capabilities, Yokogawa is well suited to meet nearly any process analyzer project required.

Furthermore, Yokogawa is truly a global company with Analyzer System Integration (ASI) facilities with experience of large install base. And GC labs strategically located around the world for regional technical support. And the GC8000 has the complete backing of the Yokogawa Global Service Structure to provide competent and dependable commissioning, field service and training services regardless of the location of the final installation.

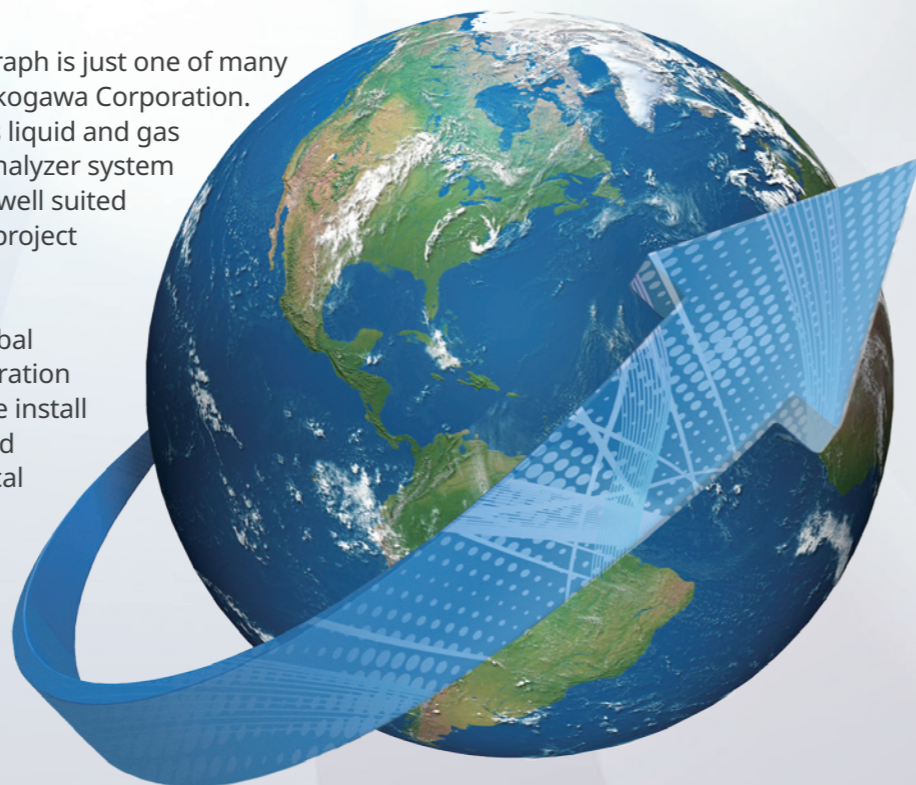

* Analyzer base sampling unit (GCSMP) can be installed in the self-standing version excluding Type 3 and Type 5. Type 5 is not available for TIIS.

Dimensions (Wall-mounting types)

Unit : mm

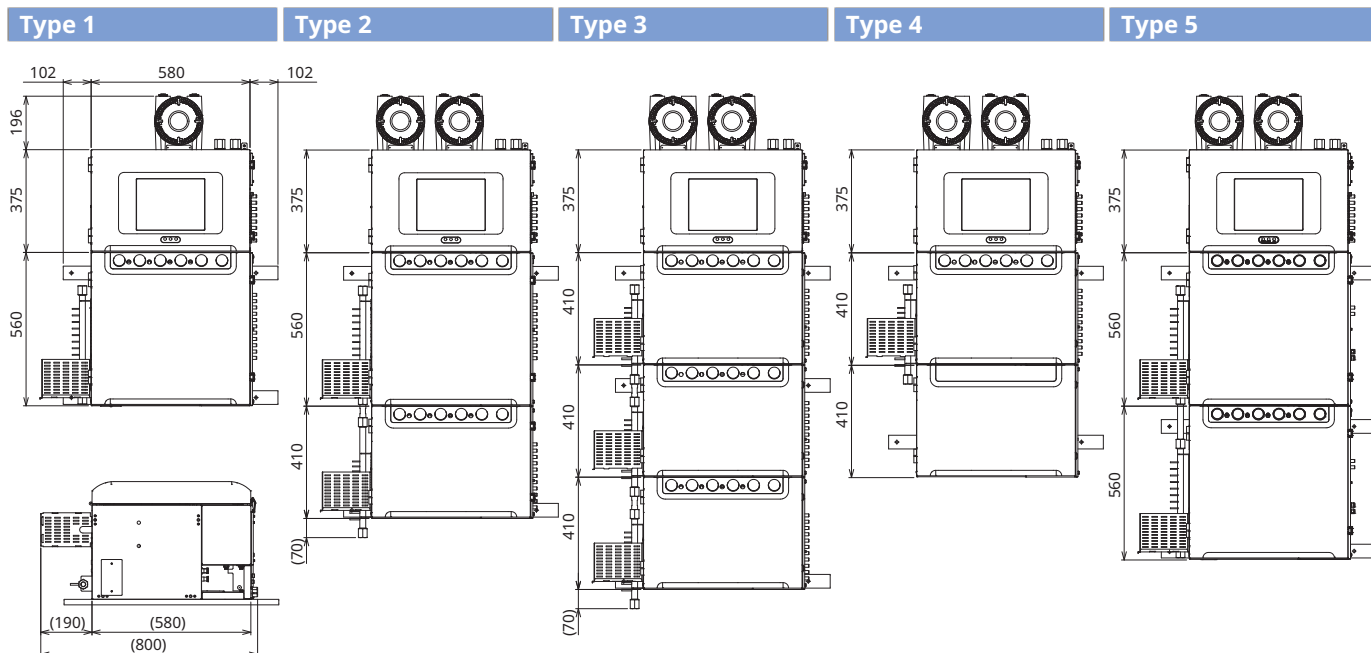

* For details, refer to GS 11B08A01-01E.

OpreX™ Yokogawa achieves operational excellence by providing products, services, and solutions based on the OpreX comprehensive brand that cover everything from business management to operations.

Trademarks

Co-innovating tomorrow are either trademarks of Yokogawa Electric Corporation.

All other company brand or product names in this bulletin are trademarks or registered trademarks of their respective holders.

YOKOGAWA ELECTRIC CORPORATION

World Headquarters

9-32, Nakacho 2-chome, Musashino-shi, Tokyo 180-8750, JAPAN

<http://www.yokogawa.com/an/>

YOKOGAWA CORPORATION OF AMERICA

YOKOGAWA EUROPE B.V.

YOKOGAWA ENGINEERING ASIA PTE. LTD.

YOKOGAWA CHINA CO., LTD.

YOKOGAWA MIDDLE EAST & AFRICA B.S.C.(c)

<http://www.yokogawa.com/us/>

<http://www.yokogawa.com/eu/>

<http://www.yokogawa.com/sg/>

<http://www.yokogawa.com/cn/>

<http://www.yokogawa.com/bh/>

Represented by:

ANA-01E

Subject to change without notice.

All Rights Reserved, Copyright © 2011, Yokogawa Electric Corporation.

[Ed:05/b]

Printed in Japan, 012(KP)