

COLOR	P/N	MAT'L	TEXT
GRAY	906	PC	BLANK
	P906	PC/PBT	"P"
BLUE	912	PC	BLANK
	P912	PC/PBT	"P"
RED	913	PC	BLANK
	P913	PC/PBT	"P"
YELLOW	914	PC	BLANK
	P914	PC/PBT	"P"
GREEN	931	PC	BLANK
	P931	PC/PBT	"P"
ORANGE	932	PC	BLANK
	P932	PC/PBT	"P"

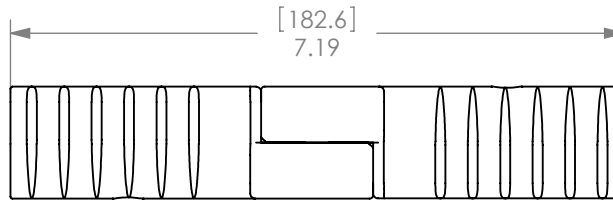
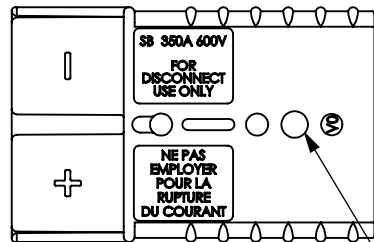
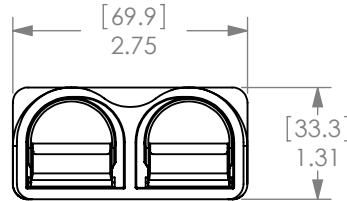
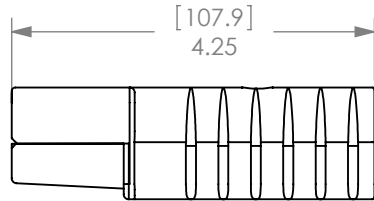

MATED PAIR

NOTES:

1. SPRING/HOUSING ASSEMBLIES ARE cURus RECOGNIZED PER FILE E26226.
2. HOUSINGS ARE KEYED TO ONLY ALLOW MATING WITH THE SAME COLOR HOUSING.
3. FOR ASSEMBLY INSTRUCTIONS SEE DOCUMENT 1S1030A
4. HOUSING ASSEMBLIES ACCOMODATE ANDERSON CONTACTS FOR WIRE RANGE FROM 1/0 TO 300MCM.

SEE TABLE FOR RAISED TEXT

REV.	DESCRIPTION	APPRV	DATE
4	ECRN-14933 COLOR & KEYING ADDED	TWE	7/5/11
3	ECRN 14661- "PC/PBT" WAS "PBT"	CMS	7/7/10
2	ECRN 14391- REDRAW, UPDATE BORDER, ADD TABLE	AMS	3/3/09
REV.	DESCRIPTION	APPRV	DATE

REVISIONS

DIMENSIONS ARE IN:		APPROVALS	
INCH	[MM]	DRAWN	CMS 03/19/99
UNLESS OTHERWISE STATED		CHECKED	DJD 03/19/99
TOLERANCES:		MFG APP	CHB 04/20/99
DECIMALS (INCH)	DECIMALS (MM)	QC APP	DJM 04/20/99
.XX ± .02	.X ± .5	ENG APP	UFN 04/19/99
ANGLES ±2°			
SURFACE FINISH:			
MACHINED	128 [3.2]		
MOLDED	64 [1.6]		
MATERIAL: SPRINGS - STAINLESS STEEL HOUSINGS - SEE TABLE			
FINISH:			
3rd ANGLE PROJECTION		-CAD GENERATED DRAWING- DO NOT MANUALLY UPDATE DO NOT SCALE	

**ANDERSON POWER PRODUCTS**

TITLE

**350A DUAL POLE SPRING & HOUSING**

SIZE: A/A4 DWG NO. 114132S1 REV. 4

SCALE: NONE CADFILE 01002 SHEET 1 OF 1

THE INFORMATION CONTAINED IN THIS DRAWING IS THE SOLE PROPERTY OF ANDERSON POWER PRODUCTS. ANY REPRODUCTION IN PART OR WHOLE WITHOUT THE WRITTEN PERMISSION OF ANDERSON POWER PRODUCTS IS PROHIBITED.

Copyright 2010

ANDERSON POWER PRODUCTS RESERVES THE RIGHT TO ALTER PRODUCT TYPES, THEIR TECHNICAL DATA, DIMENSION, STYLE AND ACCESSORIES WITHOUT PRIOR NOTIFICATION.

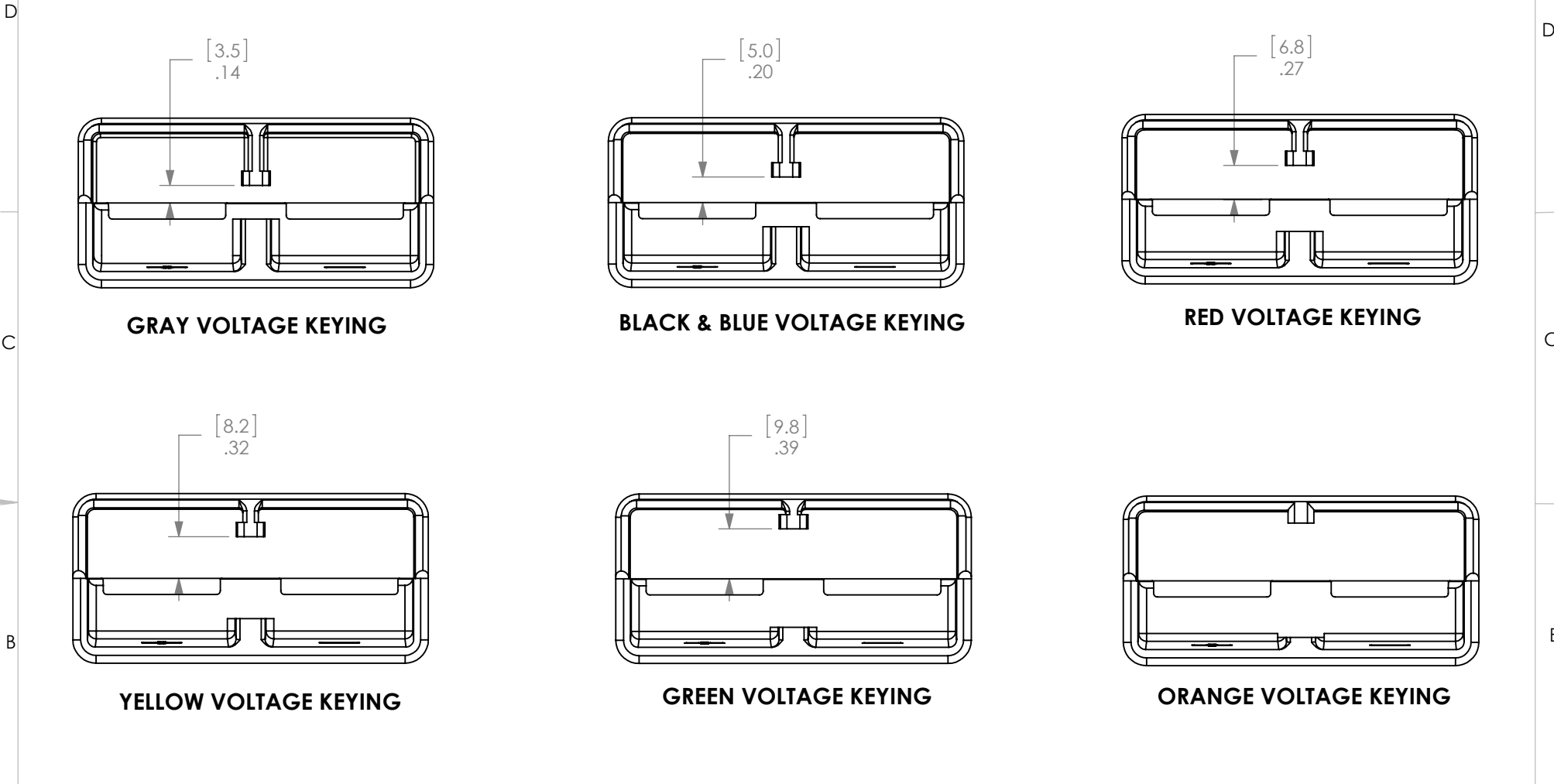

GRAY VOLTAGE KEYING



BLACK & BLUE VOLTAGE KEYING

RED VOLTAGE KEYING

YELLOW VOLTAGE KEYING

GREEN VOLTAGE KEYING

ORANGE VOLTAGE KEYING

DIMENSIONS ARE IN: INCH[MM] MM[INCH]		<b>APPROVALS</b>		 <b>ANDERSON POWER PRODUCTS</b> <b>TITLE</b> <b>350A DUAL POLE SPRING &amp; HOUSING</b>
UNLESS OTHERWISE STATED TOLERANCES:		<b>DRAWN</b> TWE	6/30/11	
DECIMALS (INCH) DECIMALS (MM) ANGLES		<b>CHECKED</b> ***		
.XX ± .02 .X ± .5 ± 2°		<b>MFG APP</b> ***		
SURFACE FINISH:		<b>QC APP</b> ***		SIZE A/A4 SCALE NONE
MACHINED 128 [3.2] MOLDED 64 [1.6]		<b>ENG APP</b> ***		
<b>MATERIAL:</b> SPRINGS - STAINLESS STEEL HOUSINGS - SEE TABLE				DWG NO. 114132S1 CADFILE 01002
<b>FINISH:</b> *****				REV. 4 SHEET 2 OF 2
 3rd ANGLE PROJECTION		 1st ANGLE PROJECTION		CAD GENERATED DRAWING - DO NOT MANUALLY UPDATE DO NOT SCALE