

/ My belle Sofa system



My belle Sofa system

Riscrivere l'idea delle aree comuni

Oggi il progetto "My belle" si presenta con un sistema di imbottiti integrato da diversi elementi funzionali. Piccola architettura sospesa sostenuta da gambe leggere, qui poggiano morbide sedute e schienali che si possono collocare in tutte le posizioni del telaio, per creare nuove versioni, in ogni momento. Senza schienali ecco che si sviluppano essenziali ma sempre eleganti panche.

My belle Sofa system trova spazio dove ci sono persone, in ambienti da valorizzare e rendere evocativi. Anche in questa versione del progetto "My belle" è evidente l'eleganza, la leggerezza e un design attuale, che resterà attuale anche domani.

Rewriting common areas idea

Today the "My belle" project presents an upholstered seating system, integrated with various functional accessories. A minimalistic suspended metal structure supported by light legs, hereon lay soft seats and curvy backrests which can be placed at any position on the frame, creating new versions any time. Without backrests, essential yet elegant benches emerge.

My belle Sofa system finds its place wherever people gather, in spaces that need to be enhanced and made evocative. This version of the "My belle" project also shows elegance, lightness, and a contemporary design that will remain contemporary also tomorrow.

Design Baldanzi & Novelli



Un sistema modulare

Si progetta, si aggiunge, si riconfigura per modellare gli spazi comuni. **My belle Sofa system** introduce una nuova libertà compositiva che segue il ritmo del lavoro, il ritmo delle persone. Le sedute e gli schienali si agganciano con semplicità. Un sistema che cambia configurazione quando cambiano i flussi, le persone e le funzioni: da lounge a meeting, da attesa a collaborazione.

A modular system

Designed, added to, and reconfigured to shape common spaces. **My belle Sofa system** introduces a new composing freedom which follows the rhythm of work, the rhythm of people. Seats and backrests link easily. A system that changes configuration as flows, people, and functions change: from lounge to meeting, from waiting to collaboration.







Sostegno e accoglienza in equilibrio

Il metallo definisce la struttura, mentre le curve sinuose della silhouette dichiarano il carattere della seduta. Un dialogo tra comfort e sostegno garantito dallo studio delle forme e da imbottiture di pregio.

Balanced support and comfort

Metal finish defines the frame, while silhouette sinuous curves define the seat's character. A dialogue between comfort and support guaranteed by careful design and high-quality padding.





La funzionalità prende forma nei dettagli

Piano orientabile e vano a giorno cablato esprimono la visione del sistema realizzato con lavorazioni artigianali che coniugano tecnica ed eleganza.

Functionality takes shape into details

The swivable writing top and the cabled open compartment express vision of the system, made with artisanal craftsmanship combining technology and elegance.







/ My belle Sofa system



Soluzioni di contenimento, funzioni ready-to-connect e accessori dedicati ampliano le possibilità di personalizzazione di **My belle Sofa system**. La seduta si trasforma in uno spazio di lavoro operativo, dove le finiture sono coordinate con l'intero progetto d'arredo.

Storage solutions, ready-to-connect features, and dedicated accessories expand **My belle Sofa system** customization options. The seating is transformed into an operational workspace, where finishes and colours coordinate with the entire furniture project.







Una nuova forma per l'area comune

Sedute e superfici si alternano creando pause e relazioni, ordine e apertura definendo un nuovo modo di abitare lo spazio condiviso.

A new shape for the common area

Seats and surfaces alternate, creating pauses and connections, order and openness, defining a new way of living shared space.



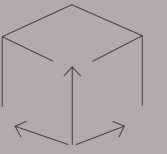

QUICK ASSEMBLY

a. horizontal lock



b. vertical clamp



c. clip together



RECONFIGURE

a. seatings & horizontal elements

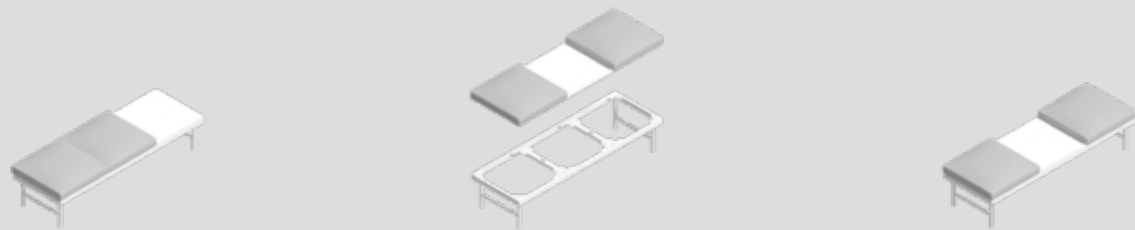

b. backs and accessories

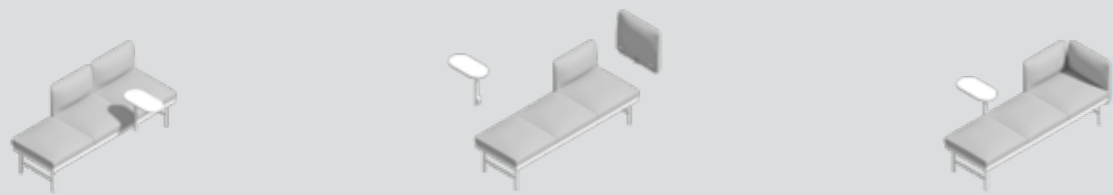

c. layout

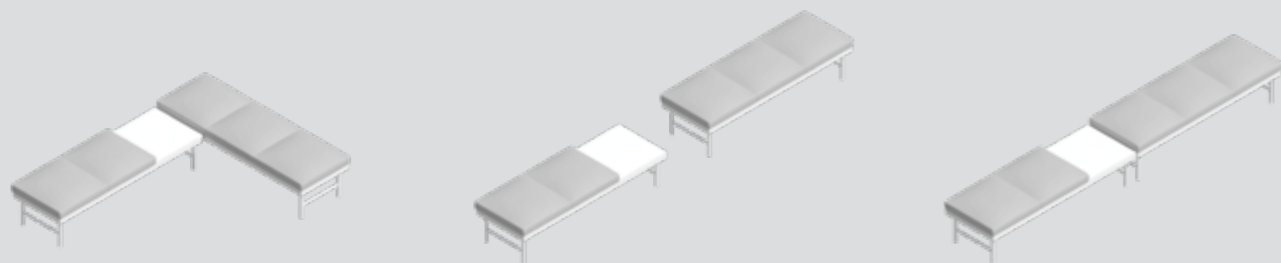

INTEGRATE & RECONFIGURE

+ 4

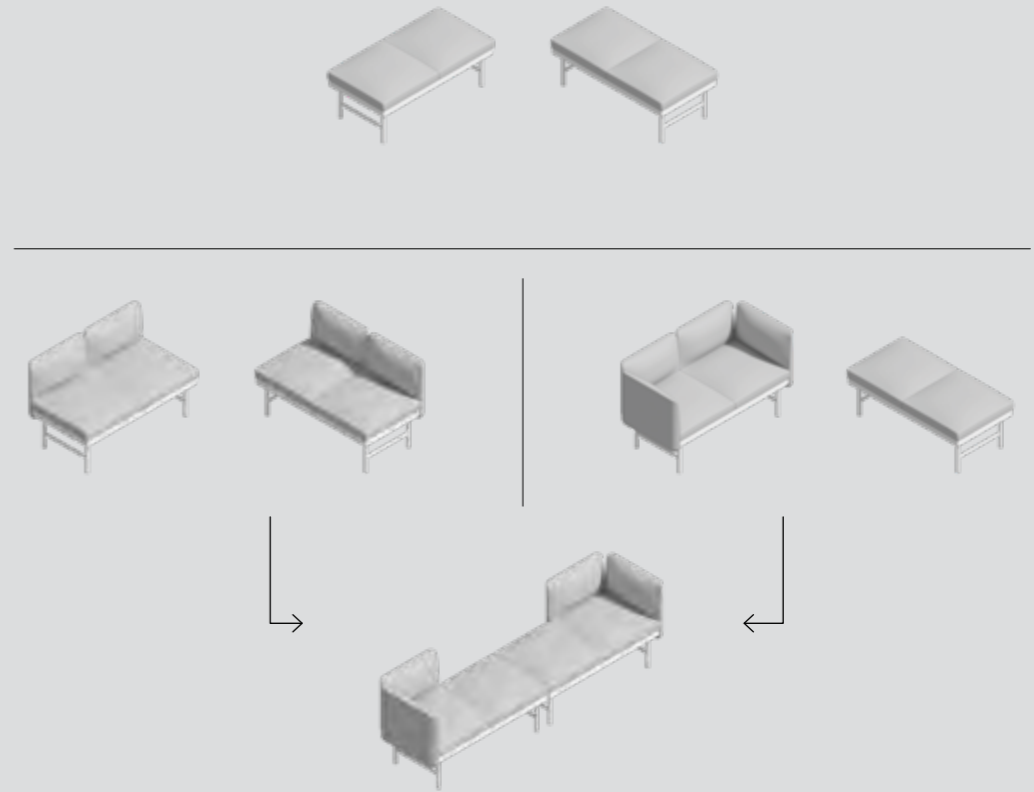

+ 1

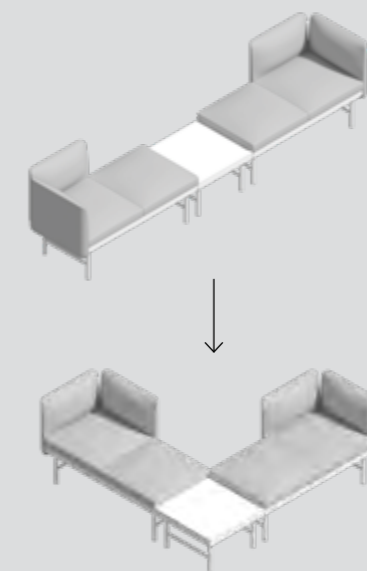

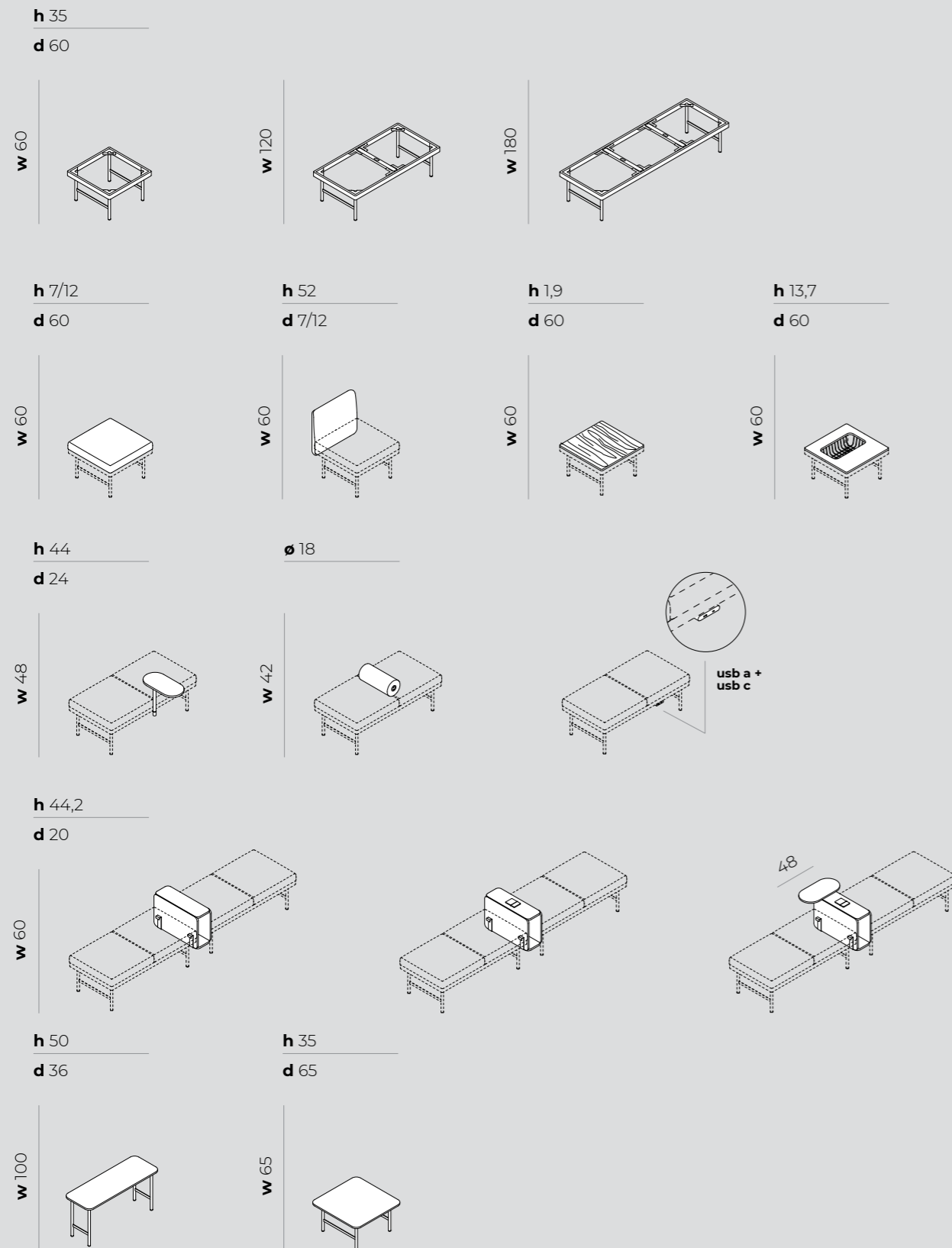

measure in cm • measurements in cm • mesures en cm • Maße in cm • medidas en cm

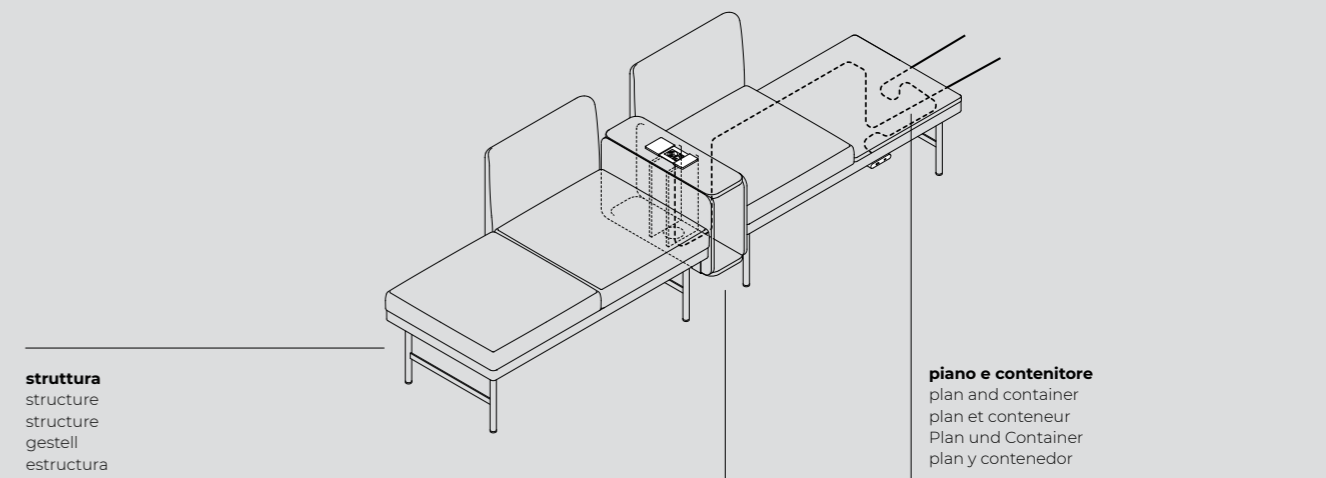

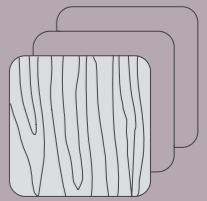

FINITURE E COLORI
finishing and colors
finitions et couleurs
Oberfläche und farben
acabados y colores





tessuto • fabric • tissu • stoff • tejido

T1 - MIRAGE

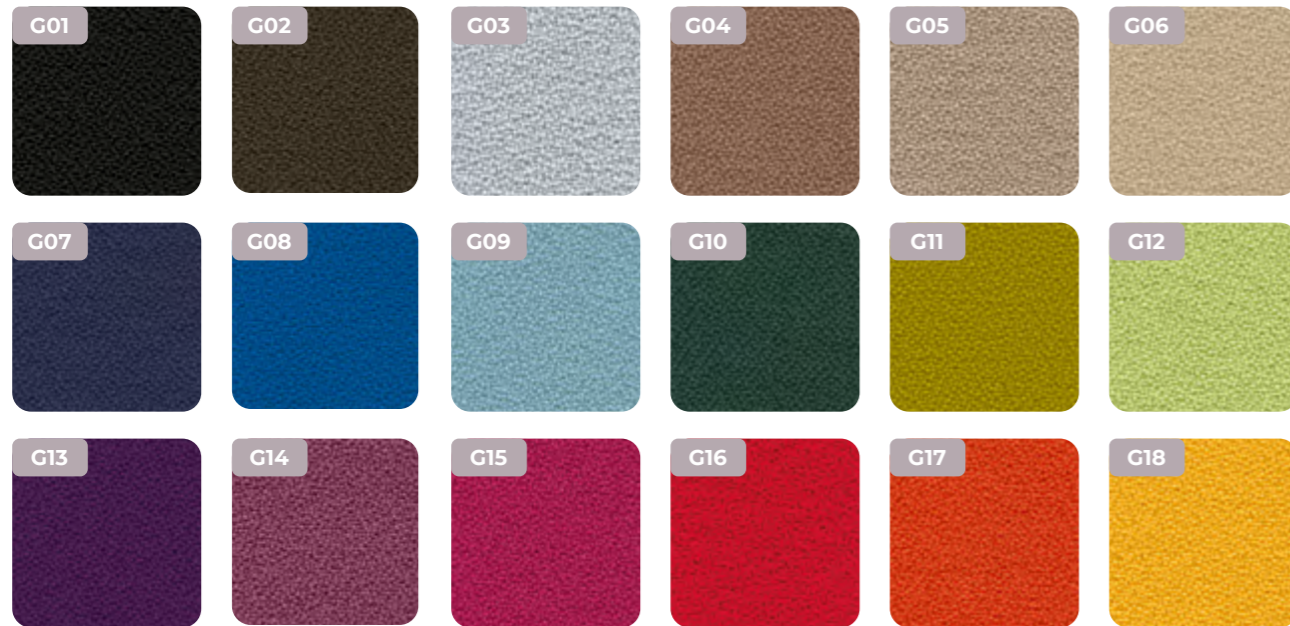

T2 - NEMI MELANGE



T2 - FENICE



T2 - CONVERT MEL 4000

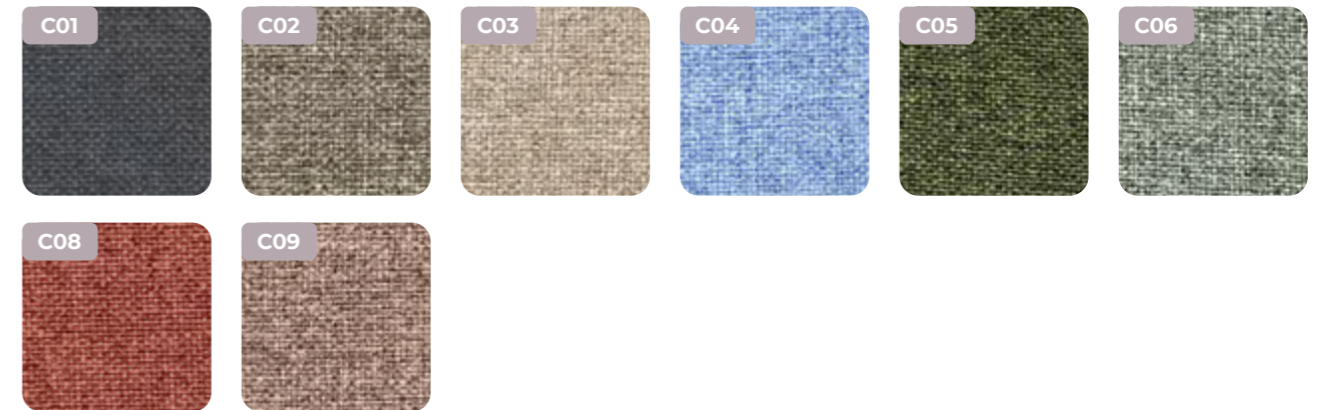

T2 - CURA

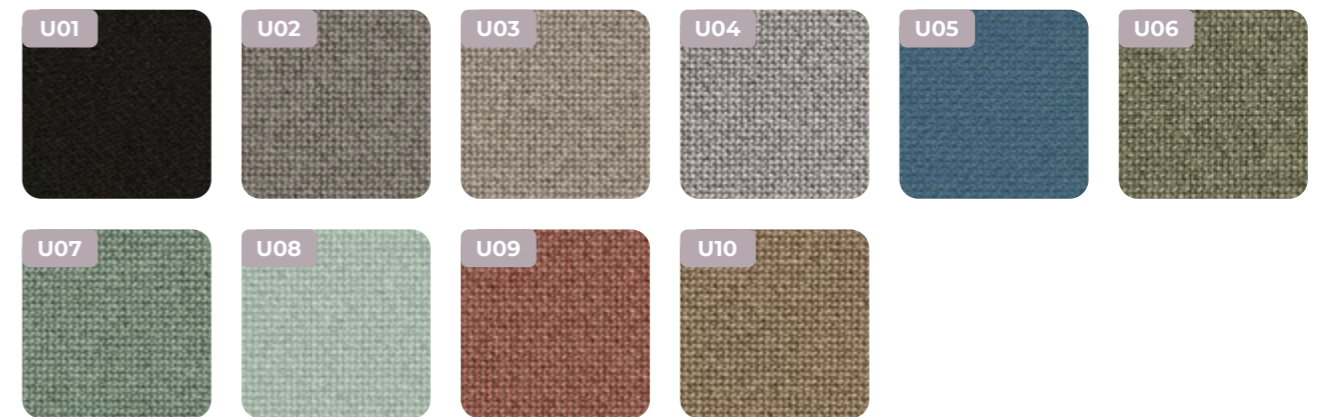

T2 - POSEIDON



T3 - CORAL

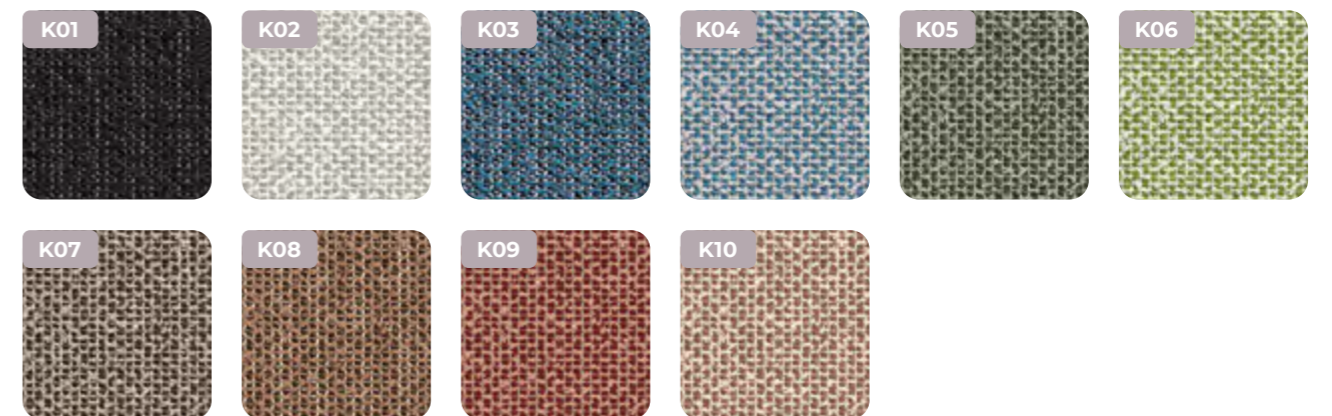



PLI - pelle • leather • peau • Leder • piel



PEI - pelle ecologica • eco-leather • peau écologique • Kunstleder • eco-piel



metallo • metal • métal • metall • metal



alluminio verniciato nero
black painted aluminum
aluminium peint noir
Aluminium Schwarz lackiert
aluminio pintado negro

grigio titanio
titanium grey
gris titane
titangrau
gris titanio

tortora
turtledove
tourterelle
taubengrau
törtola

bianco
white
blanc
weiß
blanco

oliva
olive
olive
olive
oliva

terracotta
terracotta
terre cuite
terrakotta
terracota



grigio ombra
shadow grey
gris ombre
vulcanschwarz
sombra gris

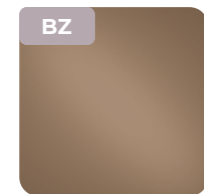

bronzo
bronze
bronce
Bronze
bronze



rame rosa
pink copper
cuivre rose
kupfer-Pink
cobre rosa

legno • veneer • bois • holz • maderá

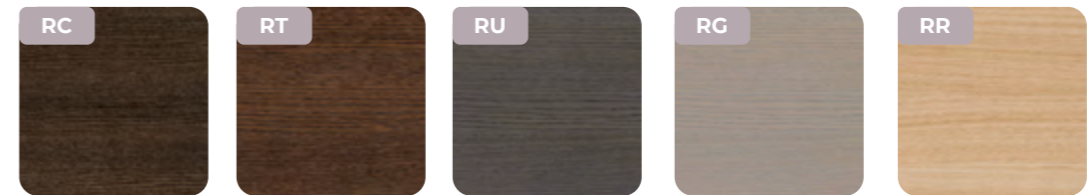

rovere Carbon
Carbon oak
chêne Carbon
Eiche Carbon
roble Carbon

rovere tabacco
tobacco oak
chêne tabac
Eiche Tabak
roble tabaco

rovere grigio scuro
dark grey oak
chêne gris foncé
dunkelgraue Eiche
roble gris oscuro

rovere grigio
grey oak
chêne gris
Eiche grau
roble gris

rovere naturale
natural oak
chêne naturel
Natur Eiche
roble natural

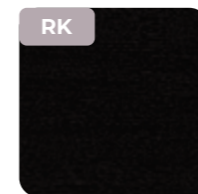

rovere laccato nero
black lacquered oak
chêne laqué noir
schwarz lackierter Eiche
roble lacado negro



rovere laccato bianco
white lacquered oak
chêne laqué blanc
weiß lackierter Eiche
roble lacado blanco



rovere laccato titanio
titanium lacquered
oak chène laqué titane
titan lackierter Eiche
roble lacado titanio



rovere laccato tortora
turtledove lacquered oak
chêne laqué tourterelle
taubengrau lackierter
Eiche roble lacado tortola

melaminico • melamine • mélamine • melamin • melamina



nero
black
noir
schwarz
negro

grigio granito
granite grey
gris granit
granitgrau
gris granito

grigio perla
pearl-grey
gris perle
perlgrau
gris perla

tortora
turtledove
tourterelle
taubengrau
törtola

bianco
white
blanc
weiß
blanco

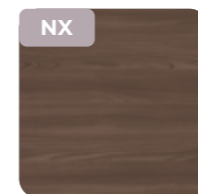

noce Lux
walnut Lux
noyer Lux
Lux Nussbaum
nogal Lux

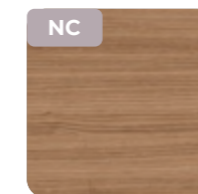

noce canaletto
canaletto walnut
noyer canaletto
Canaletto Nussbaum
nogal canaletto



rovere naturale
natural oak
chêne naturel
Natur Eiche
roble natural

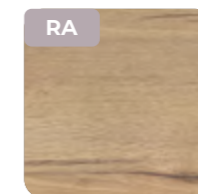

rovere anticato
traditional oak
chêne vieilli
Eiche Antik
roble antiguo

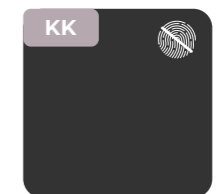

nero opaco
matt black
noir mat
mattschwarz
negro mate

laccato opaco • lacquered matt • laqué mat • matt lackiert • lacado mate

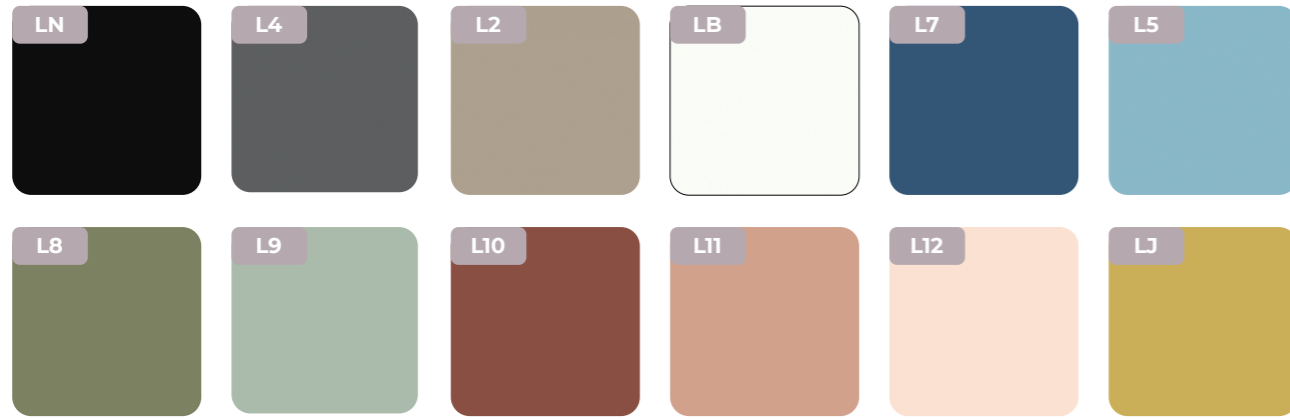

selezione delle materie prime • selection of raw materials • sélection des matières premières • Auswahl der Rohstoffe • seleccion de materias primas

attenzione e cura nella scelta dei materiali: Legno impiallacciato / vetro / pelle / tessuto • attention and care in the selection of materials: veneer / glass / leather / fabric • attention et soin dans la sélection des matériaux: bois plaquage / verre / peau / tissu • Aufmerksamkeit und Sorgfalt bei der Auswahl der Materialien: Holzfurnier / Glas / Leder / Stoff • atención y cuidado en la selección de los materiales: madera pintada / vidrio / piel / tejido



produzione certificata, ecologica e rispettosa dell'ambiente e dell'utente • certified production, green environmentally and user friendly • production certifiée, écologique et respectueuse de l'environnement et de l'individu • Zertifizierte, umweltfreundliche Produktion mit großer Respekt für Umwelt und Nutzer • Produccion certificada, ecologica y respetuosa del ambiente y del usuario



progettazione • space planning • projets • Projekte • proyectos



capacità di produzione industriale • industrial production ability • capacité de production industrielle • industrielle Produktionskapazität • capacidad de producción industrial



garanzia e disponibilità dei componenti • warranty and availability of components • garantie et disponibilité des composants • Garantie und Verfügbarkeit der Komponenten • garantía y disponibilidad de los componentes



esperienza • experience • expérience • Erfahrung • experiencia



articoli speciali • special items • articles spéciaux • Sonderanfertigungen • artículos especiales



imballi costituiti da materiali facilmente separabili e riciclabili • recyclable and easy to dispose packagings • emballages constitués de matériaux facilement séparables et recyclables • Die Verpackungen ermöglichen ein schnelles Trennen und Wiederverwertung von Materialien • embalaje constituido de materiales simplemente separables y reciclables



riduzione di formaldeide e di sostanze tossiche e potenzialmente dannose • low formaldehyde emission, low toxic and potentially harmful substances • réduction de formaldéhyde et des substances toxiques et potentiellement nocives • Reduzierung von Formaldehyd und Giftstoffe, die eine potentielle Gefahr darstellen • reducción de formaldehido y sustancias tóxicas y que pueden ser dañinas



estensione del ciclo di vita dei prodotti • product life extension • extension du cycle de vie du produit • Erweiterung der Produktlebensdauer • extension del ciclo de vida de los productos



produzione di arredi a ridotto impatto ambientale • furniture products with reduced environmental impact • production de mobiliers à impact environnemental réduit • Produktion von Einrichtungen mit niedriger Umweltbelastung • producción de mobiliario con reducido impacto ambiental



facilità di disassemblaggio per favorire la riconfigurabilità, il riutilizzo o il riciclo • easy reconfiguration, reuse or recycling • simplicité de démontage pour favoriser la reconfiguration, la réutilisation ou le recyclage • Leichte Zerlegung um Rekonfigurierbarkeit, Wiederverwendung oder Recycling zu ermöglichen • facilidad de desensamblaje para facilitar el configurar de nuevo, reutilizar y reciclar

il nostro sistema di produzione segue standard avanzati per la cura dell'individuo e della natura • our production system follows advanced standards for individual and nature care • notre système de production suit des standards avancées pour le soin de l'individu et de la nature • Unser Produktionsverfahren fortschrittlichen Standards für den Schutz von Mensch und Natur • nuestro sistema de producción sigue estandard avanzados para el cuidado al individuo y a la naturaleza.

la nostra azienda opera con l'obiettivo primario di garantire prodotti che raggiungano un corretto equilibrio tra sostenibilità ambientale e design • our Company operates with the primary objective of guaranteeing products that achieve a correct balance between, environmental sustainability and design • notre société a comme objectif principal celui de garantir des produits qui atteignent un juste équilibre entre, durabilité environnementale et design • Unsere Firma hat sich als Hauptziel die Garantie von Produkten gesetzt, welche ein korrektes Gleichgewicht zwischen Umweltverträglichkeit und Design erzielen • nuestra empresa trabaja con el objetivo primario de garantizar productos que alcanzan un correcto equilibrio entre sostenibilidad ambiental y de diseño



The mark of responsible forestry

I nostri prodotti in melaminico possono essere forniti con certificazione FSC® su richiesta cliente • Our melamine products can be with FSC® certification supplied upon customer request • Nos produits en mélaminé peuvent être fournis avec certification FSC® sur demande du client • Unsere Melamin-Produkte können auf Anfrage des Kunden mit Zertifizierung FSC® geliefert werden • Nuestros productos de melamina pueden ser suministrados con certificación FSC® a petición del cliente



California 93120
Compliant for Formaldehyde Phase 2



Bralco Srl
Via Luigi Einaudi, 1
31058 Susegana (TV) Italy

T +39 0438 43 77
info@bralco.it
bralco.it

follow us on:



project: gherardi architetti
images: gherardi architetti, helios digital
printed: grafiche antiga
03_2026

Particolari tecnici ed estetici possono essere modificati senza preavviso.
Le rese cromatiche non sono vincolanti così come la fedeltà della riproduzione.
Dati, misure e dettagli devono essere verificati con il listino.

Technical and aesthetic details can be modified without notice.
Colour rendering may differ.
Check the data, measures and details on the price list.

Les détails techniques et esthétiques peuvent être modifiés sans préavis.
Le rendu chromatique n'est pas contractuel, ainsi que la fidélité de la reproduction.
Les données, les mesures et les détails doivent être vérifiés avec le tarif.

Technische und ästhetische Details könnten ohne Voranmeldung geändert werden.
Die Echtheit der Farbwiedergabe ist nicht verbindlich.
Daten, Maße und Details sind in der Preisliste zu überprüfen.

Los detalles técnicos y estéticos pueden ser modificados sin preaviso.
Los rendimientos de color y la fidelidad de la reproducción no son vinculantes.
Los datos, las medidas y los detalles deben ser verificados con la tarifa de precios.



