

SPC1 Series

Single phase, Power Controller

■ Features

- **Various and simple input specification**
 - DC4-20mA, 1-5VDC, External 24VDC
 - External adjuster(1kΩ)
 - External contact(ON/OFF)
- **Various function**
 - Out ADJ(output limit) function
 - Soft Start function(except for ON/OFF control type)
 - Out display function
 - 50/60Hz automatic converting function
- **Various control type by mode switches**
 - Phase control type
 - Cycle control type(zero cross)
 - ON/OFF control type(zero cross)



⚠ Please read "Caution for your safety" in operation manual before using.

■ Ordering information

SPC	1	-	35	
				Rated load current
				Control phase
				Item
			35	35A
			50	50A
			1	Single phase
			SPC	Solid state power controller

■ Specifications

Model		SPC1-35	SPC1-50
Power supply		220VAC 50/60Hz	
Allowable voltage range		90 to 110% of rated voltage	
Maximum rated current		35A(single phase)	50A(single phase)
Control power		220VAC	
Control range		Phase control: 0 to 98%, Cycle control: 0 to 100%	
Application load		Resistance load(min. load : over 5% of rated current)	
Cooling method		Natural cooling	
Control circuit		Micom control type	
Control input		• 1-5VDC • DC4-20mA(250Ω) • External VR(1kΩ) • ON/OFF(external relay contact or 24VDC) • Output limit input(front OUT ADJ. VR)	
Control type	By selection S/W	• Phase control ^{※1} • Cycle control(zero cross)-Period 0.5sec., 2.0sec., 10sec. ^{※1} • ON/OFF control(zero cross)	
Starting type		Soft start(0 to 50 sec. variable)	
Display function		Output indication(LED)	
Insulation resistance		100MΩ(at 500VDC megger)	
Dielectric strength		2000VAC 50/60Hz for 1minute	
Noise strength		±2kV the square wave noise (pulse width: 1us) by the noise simulator	
Vibration	Mechanical	0.75mm amplitude at frequency of 10 to 55Hz (for 1 min.) in each of X, Y, Z directions for 1 hour	
	Malfunction	0.5mm amplitude at frequency of 10 to 55Hz (for 1 min.) in each of X, Y, Z directions for 10 min.	
Shock	Mechanical	300m/s ² (approx. 30G) in each of X, Y, Z directions for 3 times	
	Malfunction	100m/s ² (approx. 10G) in each of X, Y, Z directions for 3 times	
Environ-ment	Ambient temperature	0 to 50°C, storage: -25 to 65°C	
	Ambient humidity	35 to 85%RH	
Unit weight		Approx. 1kg	

※1: Refer to ☉ **Control mode selection.**

※Environment resistance is rated at no freezing or condensation.

Power Controller

■ Dimensions

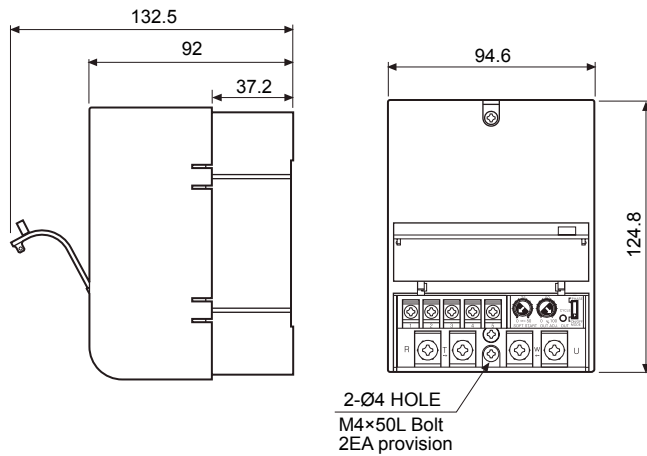

● Panel lay-out

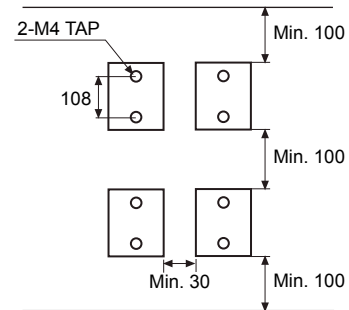

※It should have enough space between units for proper cooling.

(unit: mm)

■ Connections

1. External connection

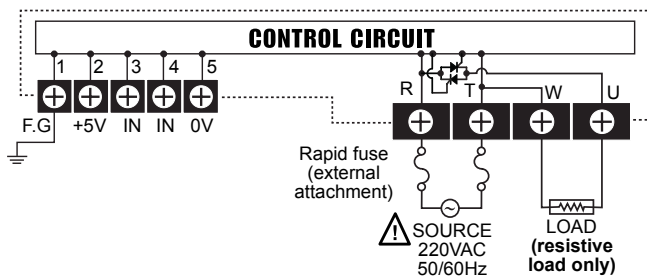

2. Connection of control input terminals

1) DC4-20mA control input

It controls 0 to 100% when you apply DC4-20mA on ④, ⑤ terminals when power is applied.

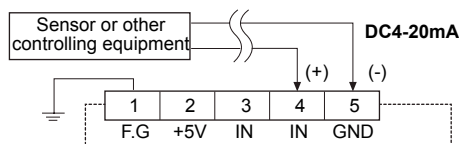

※It is not available in ON/OFF control mode.

2) 1-5VDC control input

It controls 0 to 100% when you apply 1-5VDC on ③, ⑤ terminals when power is applied.

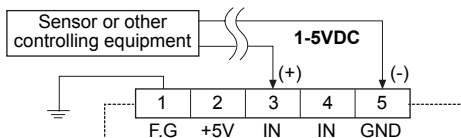

※It is not available in ON/OFF control mode.

3) ON/OFF External contact control input

It controls 100% if you connect external switch or relay contact to ②, ③ terminal when it is ON, it controls 0% when it is OFF.

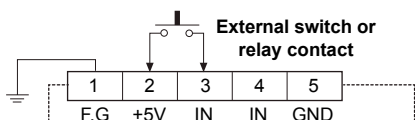

※It is available in all control modes.
OUT ADJ. and SOFT START function are not available in ON/OFF control mode.

(A) Photo electric sensor

(B) Fiber optic sensor

(C) Door/Area sensor

(D) Proximity sensor

(E) Pressure sensor

(F) Rotary encoder

(G) Connector/Socket

(H) Temp. controller

(I) SSR/Power controller

(J) Counter

(K) Timer

(L) Panel meter

(M) Tacho/Speed/Pulse meter

(N) Display unit

(O) Sensor controller

(P) Switching mode power supply

(Q) Stepper motor& Driver&Controller

(R) Graphic/Logic panel

(S) Field network device

(T) Software

(U) Other

SPC1 Series

4) External adjuster control input

After power is applied, connecting the external adjuster 1kΩ to ②, ③ and ⑤ terminals and turning adjuster control from 0% to 100%.

It is available to control as OUT ADJ, adjuster for the above 1), 2), 3) and set at 100% when it is not used.

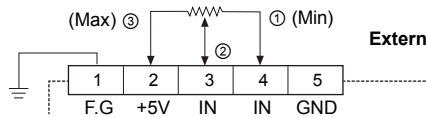

※It is not available in ON/OFF control mode.

5) External 24VDC control input

It can be used with external 24VDC voltage as below.

It is available to control of ON/OFF, outputs 100% for applying 24VDC and 0% for applying 0VDC.

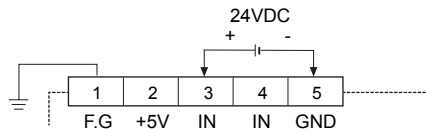

※It is available in all control modes.
OUT ADJ and SOFT START function are not available in ON/OFF control mode.

■ Front panel identification

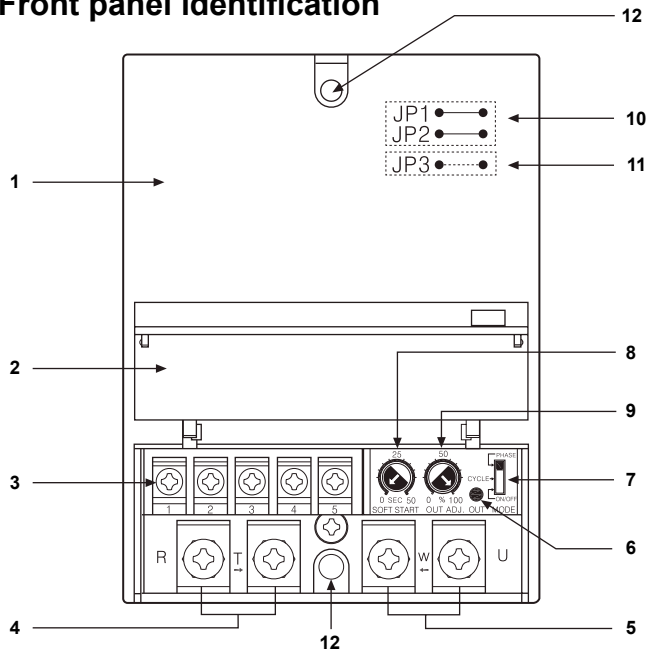

1. Case
2. Terminal block cover
3. Terminal block for control input
4. Terminal block of the power
5. Terminal block for load connection
6. LED display for output
7. Selection S/W of control mode
8. SOFT START adjusting volume
9. OUT ADJ. volume
10. Selection jumper of control period
11. Selection jumper of control type
12. The hole for fixing on panel
(Bolt size:M4×50mm)

※ 10, 11 are placed on the inner PCB of the product.

■ Factory default

Control mode	Phase control mode
Control type	Phase equality division type according to control input
Control cycle	0.5sec. (JP1, JP2 short)
SOFT START setting	0sec
OUT ADJ. setting	100%

■ Operation and function

○ Front

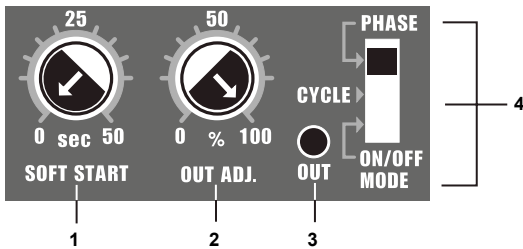

1. SOFT START time setting adjuster(0 to 50sec.)
2. Output limiting setting adjuster(0 to 100%)
3. Output operation display LED
4. Control mode switch

PHASE : Phase control mode
 CYCLE : Cycle control mode
 ON/OFF : ON/OFF control mode

○ Control mode selection

Control mode	Phase control mode	Cycle control mode (zero cross)	ON/OFF control mode (zero cross)
Mode switch			

※When selecting cycle control mode, the cycle has been set as 0.5sec. It can be changed to 2.0sec, 10sec by selection.
 ※The mode cannot be changed during it is operating. **Turn OFF the power at first** then change the mode and supply the power again.

1) Phase control

It is output type to control phase of an alternating signal according to control input signal.

● Equality division type of phase by control input

This is analog type to output control angle with dividing equally according as control input signal. It shows power characteristic as (Fig. 1) and it might occur over power and lack power at point middle of control input.

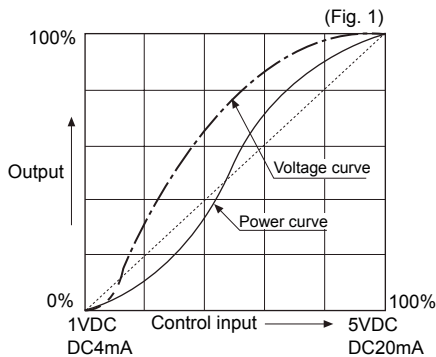

● Equality division type of power by control input

It divides control angle non-equally according as control input signal then make power curve linerization, so it becomes possible to output the power, which is proportioned control input as outputting (Fig. 1).

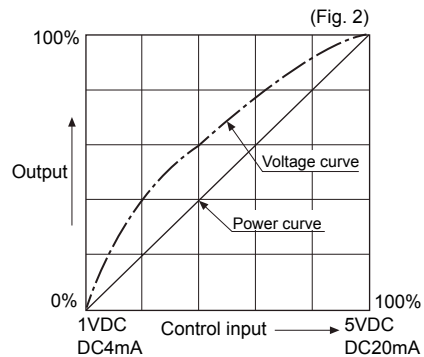

※To change the control method, change TP3 of PCB as below.

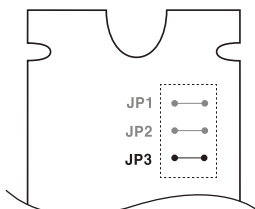

JP3	Division method(control method)
SHORT	Equal division of phase according to control input
OPEN	Equal division of power according to control input

※ SHORT OPEN

2) Cycle control-Zero cross

It controls the power, which is applied into the load to repeat ON/OFF cycle like below picture with constant proportion according to control input signal. It is easy to control the load and there is no ON/OFF noise because it turns ON and OFF at the zero point of AC.

Usually it is used in a place or electric furnace which is not easily effected by external noise.

(A) Photo electric sensor

(B) Fiber optic sensor

(C) Door/Area sensor

(D) Proximity sensor

(E) Pressure sensor

(F) Rotary encoder

(G) Connector/Socket

(H) Temp. controller

(I) SSR/Power controller

(J) Counter

(K) Timer

(L) Panel meter

(M) Tacho/Speed/ Pulse meter

(N) Display unit

(O) Sensor controller

(P) Switching mode power supply

(Q) Stepper motor& Driver&Controller

(R) Graphic/Logic panel

(S) Field network device

(T) Software

(U) Other

SPC1 Series

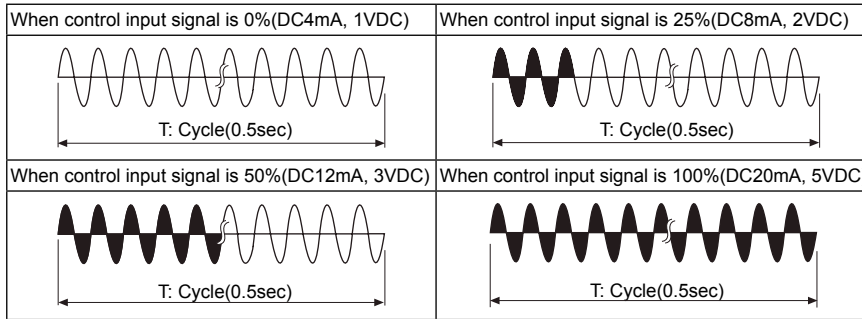

※To change cycle, please change JP1 and JP2 of PCB as below.

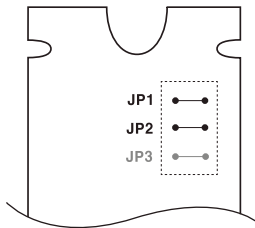

JP1	JP2	Cycle(sec.)
SHORT	SHORT	0.5sec
SHORT	OPEN	2.0sec
OPEN	SHORT	10sec
OPEN	OPEN	X(not used)



3) ON/OFF control-Zero cross

This function is when control input is ON, output is 100%. When it is OFF, output is 0%.

It is the same function as SSR(Solid State Relay). (ON and OFF is operated on the ZERO point of AC.)

※OUT ADJ. and SOFT START function are not available in ON/OFF control.

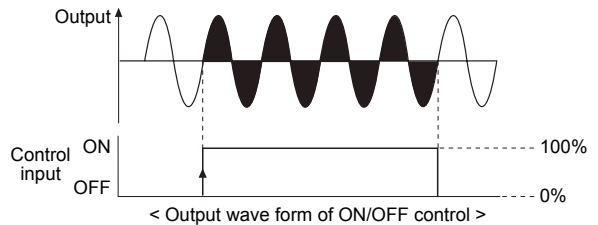

◎ OUT ADJ. (output limit) (0 to 100%)

This function will be [Control input(%) × OUT ADJ.(%) = Output] and it controls the power supplied into the load. Although control input is 100% (5V or 20mA), the output is the 50% which is proportioned with OUT ADJ. When not using OUT ADJ. function, please make set value 100%.

※This function must not be used in ON/OFF control mode.

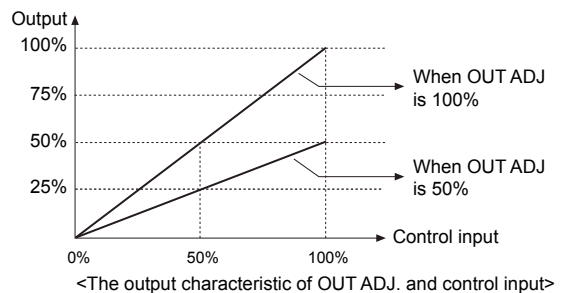

◎ SOFT START (0 to 50sec.)

When the power is supplied, this function is able to protect the load when it controls load(molybdan, white gold, infrared lamp) with inrush current or the width of rising temperature in big(SV is big).

SOFT START set time (T) is the required time that output reaches to 100%, and it is differentiated by OUT ADJ. set value. For example, SOFT START is set as 10sec and OUT ADJ. is set as 70%, it takes 7sec. to reach goal output.

[Set time (T)×OUT ADJ. set value (%)=10sec.×0.7 = 7sec.]

If increasing the OUT ADJ. before output reaches to goal output, it delays as much as the value, multiply of increased value (%) and SOFT START set time. When not using SOFT START function, please make set value 0.

※This function must not be used in ON/OFF control mode.

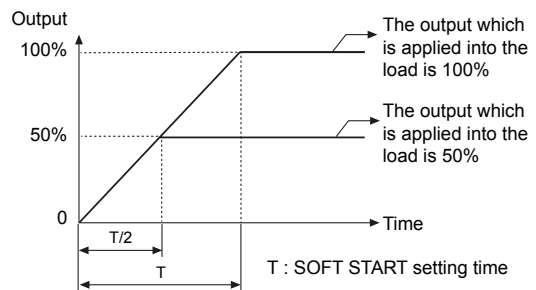

※T: Time to get the output which is applied into the load is 100%.

T/2: Time to get the output which is applied into the load is 50%.

◎ OUT display

This is LED lamp to display the status of output and will be getting brighter according as output.

(0%: Min. LED light, 100%: Max. LED light)

■ Applications

Ex1) When it needs to control accurately by adjusting the power in phase control and cycle control mode. For example, if it needs to control 80% output when it is ON, 24% output when it is OFF, please keep below.

Firstly set OUT ADJ. as 80% and connect external adjuster and external relay contact switch as the figure then set external adjuster as 30%.

- When the External contact signal is ON
: $100\%(\text{External contact input}) \times 80\%(\text{Out ADJ.}) = 80\%$
- When the External contact signal is OFF
: $30\%(\text{Adjuster input}) \times 80\%(\text{Out ADJ.}) = 24\%$

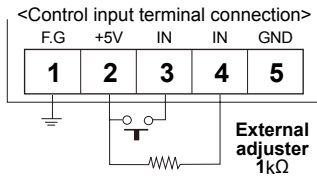

Ex2) This is how to control 0 to 100% without external adjuster in phase control mode and cycle control mode.

It is possible to control 0 to 100% by turning OUT ADJ. in state of connecting terminal 2 and terminal 3.

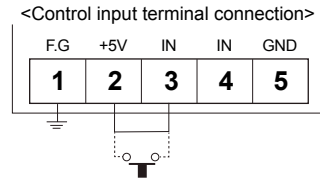

■ Temperature characteristic curve

◎ SPC1-35

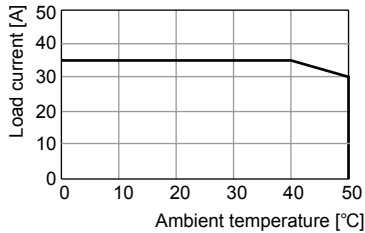

◎ SPC1-50

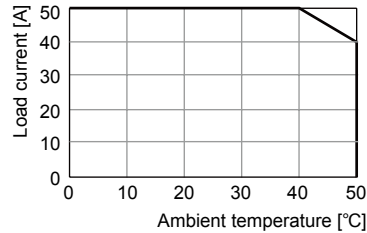

■ Proper usage

⚠ Warning

**When using this item, ground F.G terminals to avoid an electric shock.
Do not touch the heat sink since it radiates high temperature.**

⚠ Caution

1. When you install it on panel, it should be installed vertically at the place, which is well ventilated. If install it horizontally, under 70% of rated current should be applied, and a vent fan needs to be installed on the upper part of panel.
2. Be careful to attach prompt fuse between R phase terminal and power.
3. If over the maximum rated current, it causes product damage.
(Do not over maximum rated current when using high rush current.)
4. Since it is only for resistive load, the inductive load cannot be used.
5. After supplying power to this unit, it has 1 to 3 sec preparation time.
6. When connecting power and load, please use the cable(When rated current is 35A : Min. 8.4mm², when rated current is 50A : Min. 13.3mm²) which is able to send the maximum rated current.
7. Before using this unit, set the proper mode and function. Especially, if the setting of Out ADJ. is 0%, it does not operate.
8. The mode cannot be changed while it is operating. Please be sure to set the proper mode after cutting the power off and then apply the power.
9. Do not use this unit as following place.
 - ① Place where corrosive or inflammable gas occur.
 - ② Place where water and oil is occurred.
 - ③ Place where there are a lot of dusts.
10. Case detachment
Please turn off the power and detach the case.
 - ① Widen lock device toward the outside with a driver.
 - ② Put the case up and separate it.



⚠ Be careful to use machine tools, it may cause an injury.

(A) Photo electric sensor

(B) Fiber optic sensor

(C) Door/Area sensor

(D) Proximity sensor

(E) Pressure sensor

(F) Rotary encoder

(G) Connector/Socket

(H) Temp. controller

(I) SSR/Power controller

(J) Counter

(K) Timer

(L) Panel meter

(M) Tacho/Speed/Pulse meter

(N) Display unit

(O) Sensor controller

(P) Switching mode power supply

(Q) Stepper motor& Driver&Controller

(R) Graphic/Logic panel

(S) Field network device

(T) Software

(U) Other