

"Dune 1200 "

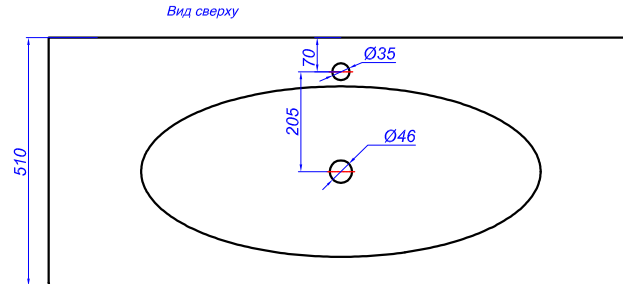

T - место подвода воды и слив

"Dune 1000 "

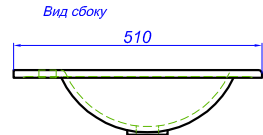
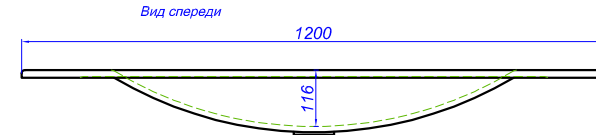
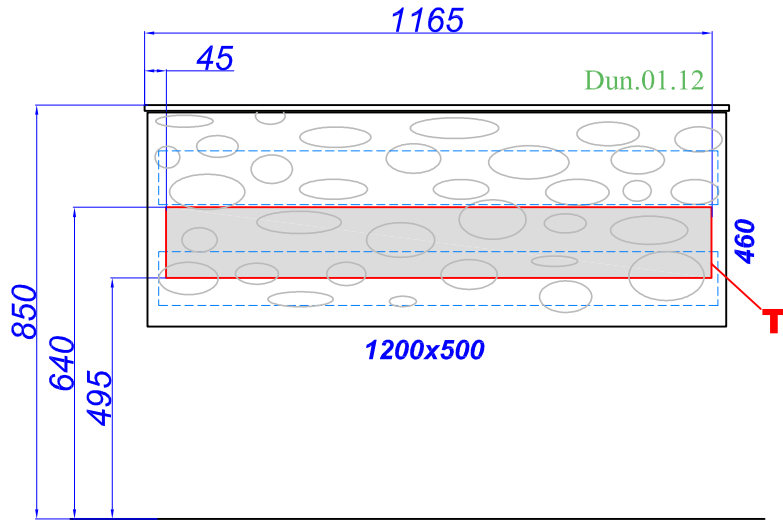
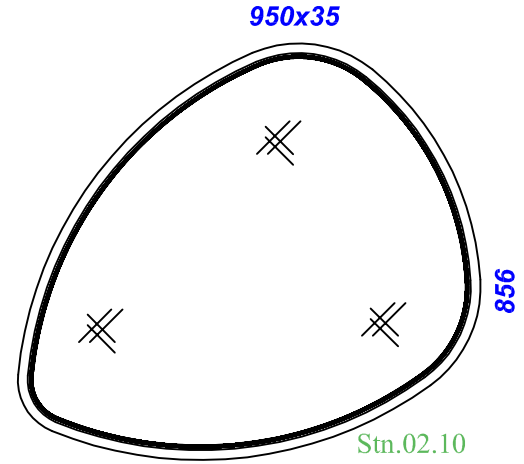
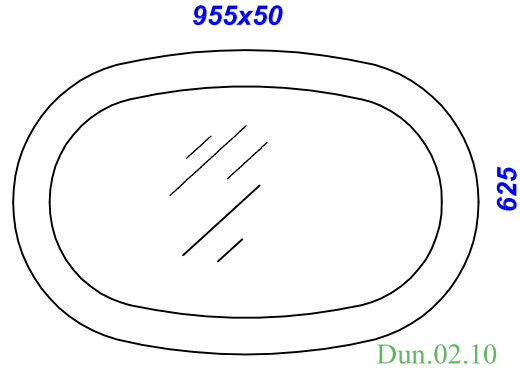
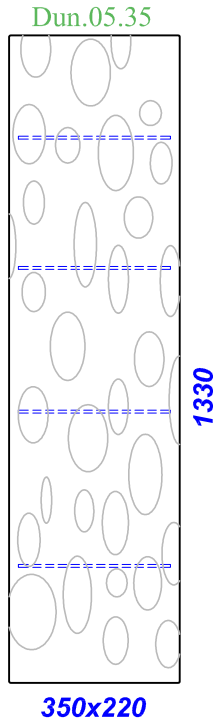
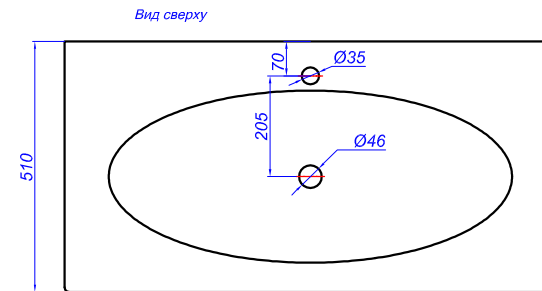
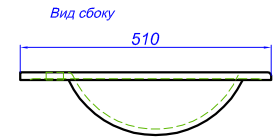
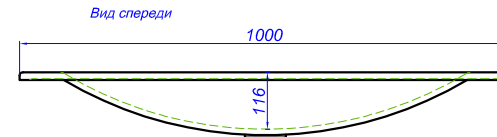
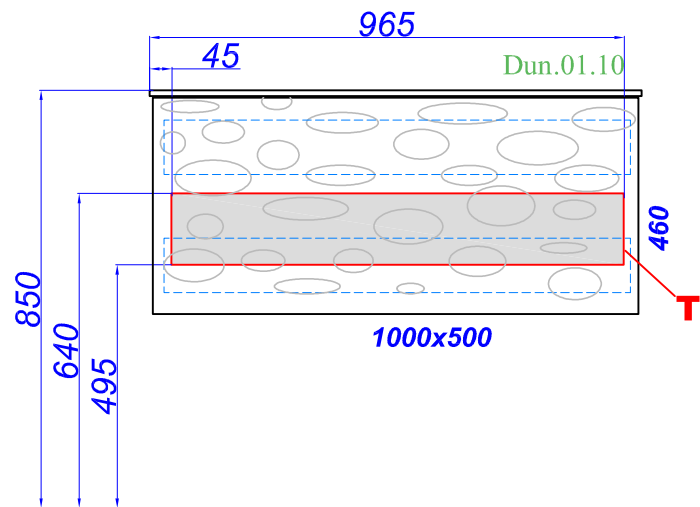
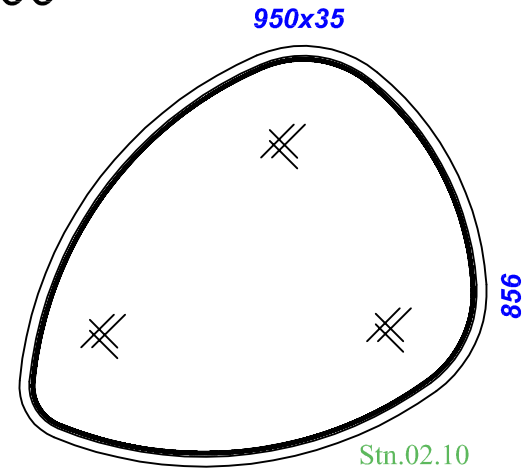
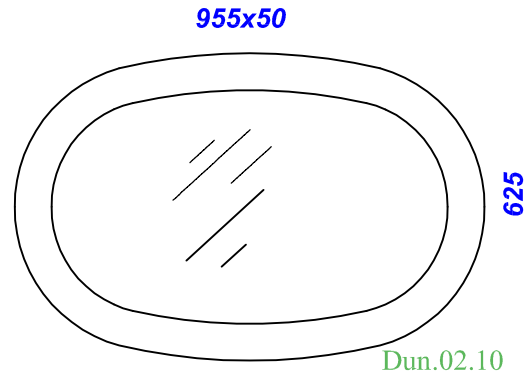
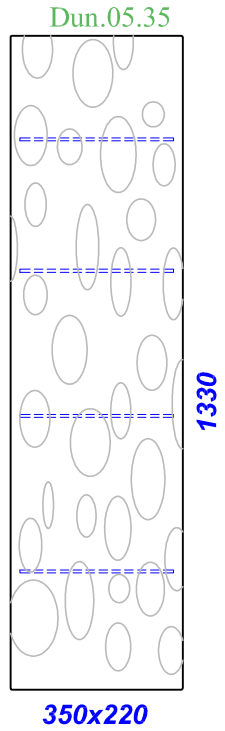

T - место подвода воды и слив